

WASHING MACHINE

INSTRUCTION BOOKLET

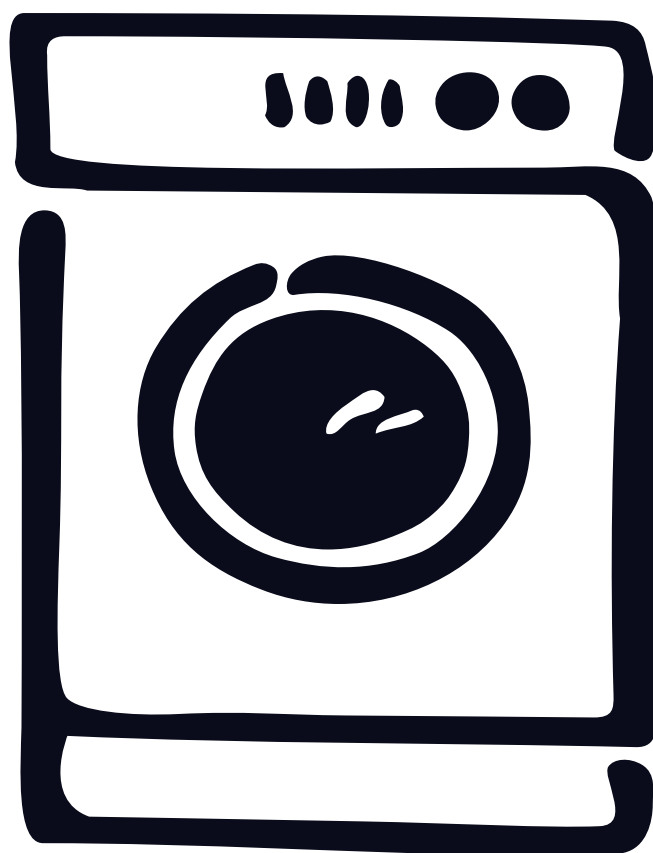

EWF 12108W
EWF 14108W



Important Safety Information

It is most important that this instruction book should be retained with the appliance for future reference. Should the appliance be sold or transferred to another owner, or should you move house and leave the appliance, always ensure that the book is supplied with the appliance in order that the new owner can get to know the functioning of the appliance and the relevant warnings.

These warnings have been provided in the interest of safety. You **MUST** read them carefully before installing or using the appliance.

Installation

- This appliance is heavy. Care should be taken when moving it.
- It is dangerous to alter the specifications or attempt to modify this product in any way.
- All packing and transit bolts must be removed before use. Serious damage can occur to the product and to property if this is not adhered to. See relevant section in instructions.
- Any plumbing work required to install this appliance should be carried out by a qualified plumber or competent person.
- Any electrical work required to install this appliance should be carried out by a qualified electrician or competent person.
- Care must be taken to ensure that the appliance does not stand on the electrical supply cable.
- If the machine is situated on a carpeted floor, please adjust the feet in order to allow air to circulate freely.
- Do not overload the appliance. See relevant section in the instruction book.
- Only wash fabrics which are designed to be machine washed. If in doubt, consult the care label on the clothes.
- Before washing, ensure that all pockets are empty and buttons and zips are fastened. Avoid washing frayed or torn articles and treat stains such as paint, ink, rust, and grass before washing. Underwired bras must NOT be machine washed.
- Any objects such as coins, safety pins, nails, screws, stones or any other hard, sharp material can cause extensive damage and must not be placed into the machine.
- Garments which have been in contact with volatile petroleum products should not be machine washed. If volatile cleaning fluids are used, care should be taken to ensure that the fluid is removed from the garment before placing in the machine.
- Wash small items such as socks, laces, washable belts etc in a washing bag or pillow case as it is possible for such items to slip down between the tub and the inner drum.
- Only use the advised quantities of fabric softener. Damage to the fabric can ensue if you over-fill. Refer to the manufacturer's recommendations of quantities.
- As some duvets and eiderdowns should be washed in large commercial machines because of their bulk, please check with the manufacturer of the item before washing in a domestic machine.
- Leave the porthole door slightly ajar between washes to preserve the door seal.
- Under no circumstances should you attempt to repair the machine yourself. Repairs carried out by inexperienced persons may cause injury or serious malfunctioning. Contact your local Service Force Centre. Always insist on genuine Electrolux spare parts.

Child Safety

- This appliance is designed to be operated by adults. Children should not be allowed to tamper with the controls or play with the product.
- Pets and children have been known to climb into washing machines. Please check your drum before use.
- The glass door becomes very hot during the washing cycle. Keep children away from the vicinity of the appliance whilst it is in operation.
- Keep all packaging well away from children.
- Keep all detergents in a safe place out of children's reach.

Use

- Always unplug the appliance and turn off the water supply after use.

Contents

For the User

Important Safety Information	2
Child safety	2
use	2
Your New Washing Machine	4

Description of the Appliance	5
Detergent dispenser drawer	5

The Control Panel	6-9
Programme information	9

Operating Sequence	10-12
Place the laundry in the drum	10
Measure out the detergent	10
Measure out the additive	10
Switch the machine ON and OFF	10
Select the required programme	10
Select the temperature	10
Select the spin speed or Rinse Hold Option	11
Select the desired option	11
Select the Delay Button	11
Start the Programme	11
How to change a programme during its cycle	11
How to interrupt a programme during its cycle	11
Cancelling a programme	12
How to open the door during the cycle programme	12
End of the programme	12

Washing Hints	13-14
Which detergent?....	14
And in which form?	14

Wash Care Symbols	15
Programme table	16-17

Maintenance and Cleaning	18-19
Descaling	18
After each wash	18
Maintenance Wash	18
External cleaning	18
Cleaning the dispenser drawer	18
Cleaning the drawer recess	18
Cleaning the pump	18-19
Cleaning the water inlet filter	19
The dangers of freezing	19
Emergency emptying out	19

Something Not Working	20-21
Service and Spare Parts	22
Customer Care	22

Guarantee Conditions	23
----------------------	-----------

For the Installer

Installation Instructions	24
Technical Specifications	24
Unpacking	25
Positioning	25
Water inlet	26
Water drainage	26-27
Levelling	27
Special conditions	27
In the interest of the environment	27
Electrical connection	28
Permanent connection	28

Guide to use the Instruction Book

The following symbols will be found in the text to guide you throughout the instructions:



Safety instructions



Hints and tips



Environmental information

Your New Washing Machine

Your new washing machine meets all modern requirements for effective treatment of laundry with low water, energy and detergent consumption.

- The programme selector dial combines the function of programme and temperature selection, making it easier to set the programme.
- The programme progress display shows the delay start, the functioning of the machine and the end of the programme .
- The special **wool** programme with its new delicate wash system treats your woollens with extreme care.
- The **Eco valve** allows total use of detergent and reduces water consumption so saving energy.
- The special **Handwash programme** with its new delicate wash system treats your delicate items with extreme care.

Ecological hints

To save water and energy and help protect the environment, we recommend that you follow these hints:

- Adjust the quantity of detergent according to the hardness of your water supply, the amount of laundry and the degree of soiling.
- A programme without prewash is sufficient for normally soiled laundry.
- The machine works more economically if it is fully loaded.
- With adequate pre-treatment, stains and limited soiling can be removed; the laundry can then be washed at a lower temperature, so saving energy.

Important

Your machine is fitted with a balance control device, which ensures the machine is stable during the spin. If the wash load appears not to have been spun sufficiently at the end of the wash cycle, because it is not evenly distributed in the drum, the balance control device may have operated. It will therefore be necessary to redistribute the wash load manually and select a spin programme. For more detailed information see the section headed "Something Not Working".

In the interest of the environment

- Materials marked with the symbol  are recyclable.
- Check with your local Council or Environmental Health Office to see if there are facilities in your area for re-cycling this appliance.
- When the appliance is to be scrapped, cut off the power supply cable and make the door lock device unusable to prevent young children from being trapped inside.
- Help to keep your country tidy - use authorised disposal sites for your old appliance.

- The symbol  on the product or on its packaging indicates that this product may not be treated as household waste. Instead it shall be handed over to the applicable collection point for the recycling of electrical and electronic equipment. By ensuring this product is disposed of correctly, you will help prevent potential negative consequences for the environment and human health, which could otherwise be caused by inappropriate waste handling of this product. For more detail information about recycling of this product, please contact your local city office, your household waste disposal service or the shop where you purchased the product.



How do we help to protect the environment? We use recycled paper!

Description of the appliance

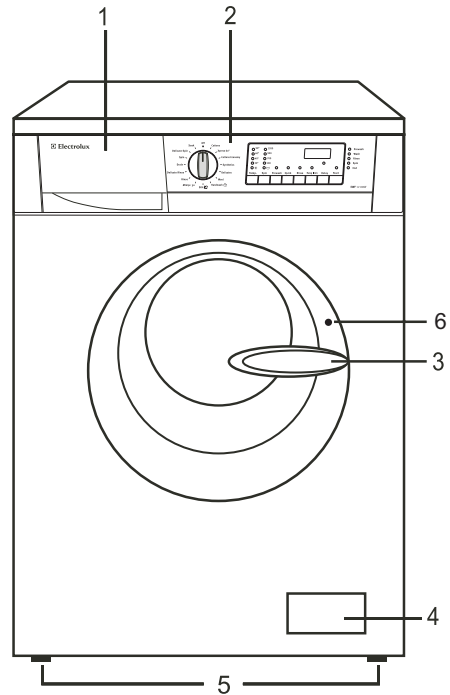
1. Detergent dispenser drawer
2. Control panel
3. Door handle
4. Drain pump
5. Adjustable feet
6. Door lock Indicator



Detergent dispenser drawer

-  Pre-wash
-  Main wash
-  Fabric softener, starch

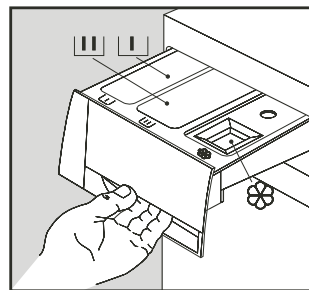

Use

Control panel

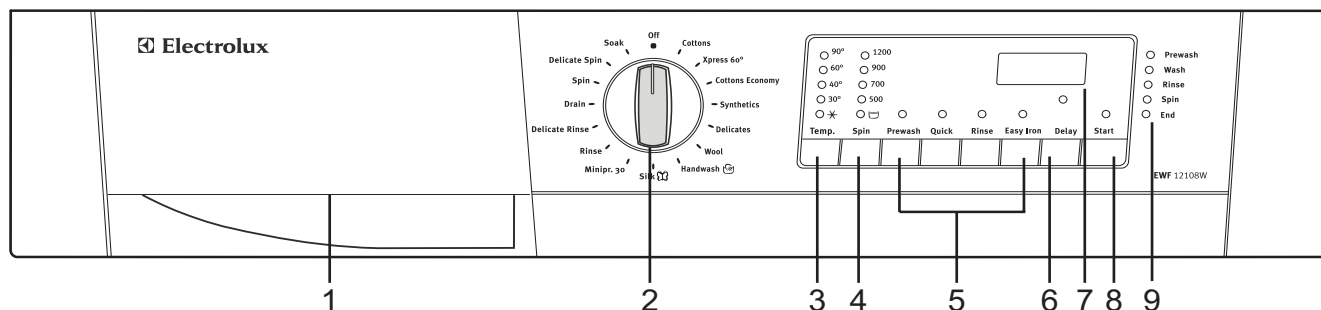

1. Detergent Dispenser Drawer

2. Programme selector dial

The programme selector dial is divided into three sections :

1. Cotton, Xpress60, Cottons Economy (Blue section)
2. Synthetics (Green section)
3. Delicates, Wool, Handwash, Silk, Minipr.30, Rinse, Delicate Rinse, Drain, Spin, Delicate Spin, Soak.(Grey section)

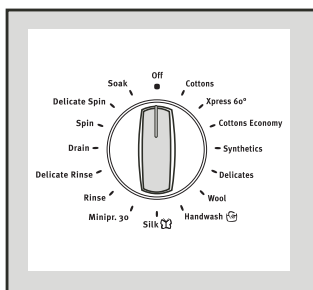

The selector dial can be turned either clockwise or anti-clockwise. Position "Cottons Economy" corresponds to an energy saving programme for cotton. At the end of programme, the selector dial must be turned to position "Off" to switch the machine OFF.

3 Temperature button "Temp."

Press this button repeatedly to increase or decrease the temperature, if you want your laundry to be washed at a temperature different from the one proposed by the washing machine.

Maximum temperatures are 90°C for cotton, 60°C for synthetic fabrics, 40°C for delicate fabrics, wool and fabrics to be hand-washed, 30°C for silk and Mini programme.

4. Spin Speed button "Spin"

Press this button repeatedly to change the spin speed, if you want your laundry to be spun at a speed different from the one proposed by the washing machine and the relevant LED will light up.

Maximum speeds for EWF 12108W are:

- for cotton: 1200 rpm
- for wool, synthetic & handwashed fabrics 900 rpm.
- for delicate, silk fabrics & mini programme: 700 rpm

Maximum speeds for EWF 14108W are:

- for cotton: 1400 rpm
- for wool, synthetic and handwashed fabrics 900 rpm.
- for delicate, silk fabrics and mini programme: 700 rpm

By pressing the Spin speed button you can also choose **Rinse Hold** option 

Rinse hold option : when you choose this option, the machine will not drain the water of the last rinse, so as not to wrinkle the laundry.

At the end of cycle, the light of "Start" button goes off, the light corresponding to rinse hold option and "End" pilot light remain lit. A flashing zero appears on the display to indicate that the water must be drained.

There are two possibilities to drain out the water.

- Select the programme “Drain”
The water is drained out without spinning
- Select programme “Spin” or “Delicate Spin”
Select the spin speed by means of the relevant button and press the “Start” button. The water is emptied out and the laundry is spun at the selected speed.

Attention: Before selecting “Drain”, “Spin” or “Delicate spin” programme, the selector dial has to be positioned on “Off”.

5. Options Button

Depending on the programme, different functions can be combined. These must be selected after choosing the desired programme and before pressing the “Start” button.

When these buttons are pressed, the corresponding LED will light up. When they are pressed again, the corresponding LED goes out.

If an incorrect option is selected, the LED flashes for about 2 seconds and the message Err is displayed. Press these buttons to select the following options:

1.Prewash: Select this option if you wish your laundry to be prewashed before the main wash (not available for wool, handwash, mini programme and silk programmes).

The Prewash ends with a short spin at 650 rpm in programmes for cotton and synthetic fabrics, whereas in the programme for delicate fabrics the water is only drained.

2.Quick: This option can be used for lightly soiled (not for wool, hand wash, silk and miniprogramme) in order to obtain a good washing programme in a short time. The washing time will be reduced according to the type of fabric and the selected temperature.

3.Rinse: This option can be selected with all programmes, except the wool and handwash programme. The machine will add 2 rinses for cottons and 1 rinse for synthetics, delicates and silk programme. This option is recommended for people who are allergic to detergents, and in areas where the water is very soft.

4.Easy Iron: Selecting this option the laundry is gently washed and spun to avoid any creasing in this way ironing is easier.

6. Delay start Button

The wash programme can be delayed from 30 min - 60 min - 90 min, 2 hours and then by 1 hour up to a maximum of 23 hours by means of this button.

Selecting the Delay Start

- Select the programme and the required options.
- Select the delay start.
- Press “Start” button: the machine starts its hourly countdown.

The programme will start after the selected delay has expired.

Delay Start cannot be used with “Drain”, “Spin” or “Delicate spin”.

Cancelling the delayed start

- Press “Start” button.
- Press “Start” button until “0” is displayed.
- Press “Start” button again.

7. Display

The display shows the following information:

Duration of the programme - Delayed start - Incorrect option selection - Alarm code - End of programme.

Duration of the selected programme

After selecting a programme, the duration is displayed in hours and minutes (for example 2.05).

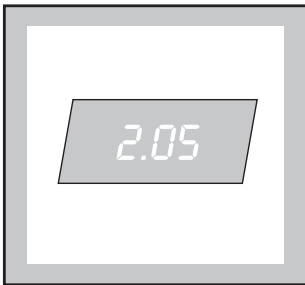

The duration is calculated automatically on the basis of the maximum recommended load for each type of fabric.

After the programme has started, the time remaining is updated every minute

Delayed start

The selected delay (23 hours max) set by means of the relevant button appears on the display for 3 seconds, then the duration of the previously selected programme is displayed.

The countdown is updated every hour and for the last 2 hours it is updated for each 30 min.

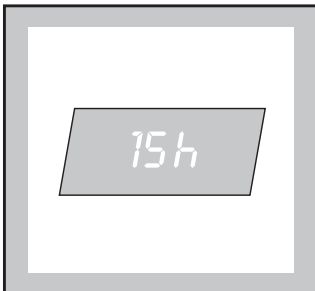

Incorrect option selection

If an option which is not compatible with the set wash programme is selected, the message **Err** is displayed for 2 seconds.

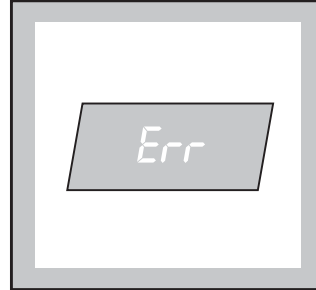

Alarm codes

In the event of operating problems, some alarm codes can be displayed, for example E20 (see paragraph "Something not working").

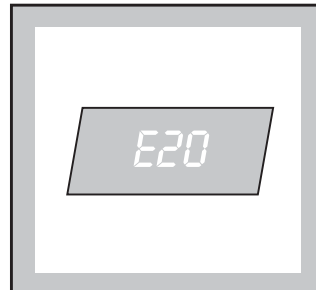

End of programme

When the programme has finished a **flashing zero** is displayed.

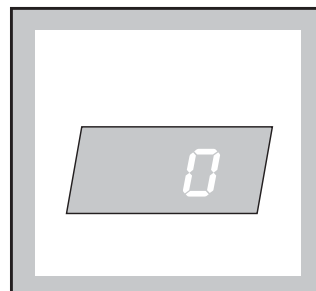

8. Start Button

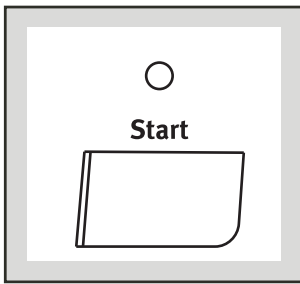

This button has two functions: Start / Pause.

Start:

After having selected the required programme, press this button to start the machine; the corresponding LED stops flashing.

If you have selected the delayed start, the machine begins its countdown. The duration of the programme or the delay appears on the display.

Pause:

To interrupt a programme which is running, press the "Start" button: the corresponding LED starts to flash.

To restart the programme from the point at which it was interrupted, press the "Start" button again

9. Programme Phase indicator Light

By selecting the wash programme, the LED corresponding to the various phases making up the programme lights.

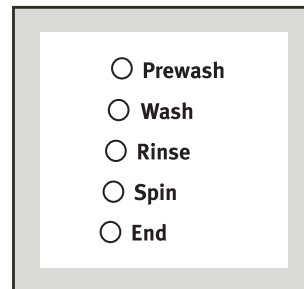

After you have started the programme, only the LED relevant to the phase that is currently being carried out will remain lit.

At the end of the programme the "End" LED illuminates.

The "End" LED flashes in the event of operating problems. And the relative alarm code appears on the display.

E10 = the machine does not fill

E20 = the machine does not empty

E40 = the door has not been closed

To eliminate the problem, see paragraph "Something not working".

i Operating sequence

Before the first wash we recommend that you pour 2 litres of water into the main wash compartment  of the detergent drawer. Then run a cotton cycle at 60°C, with the machine empty, in order to remove any manufacturing residue from the drum and tub.

Pour half a measure of detergent into the main wash compartment and start up the machine.

1. Place the laundry in the drum

Open the door. Place the laundry in the drum, one item at a time, shaking them out as much as possible. Close the door.

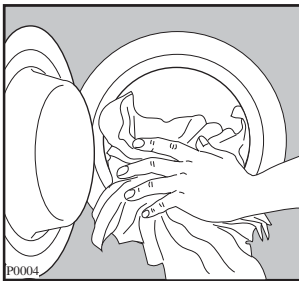

2. Measure out the detergent

Pull out the dispenser drawer until it stops. Measure out the amount of detergent recommended by the manufacturer in a graduated cup and pour it into the main wash compartment .

If you wish to carry out the prewash or soak phase, pour detergent into the appropriate compartment marked .

3. Measure out the additive

If required, pour fabric softener into the compartment marked , without exceeding the «MAX» mark.

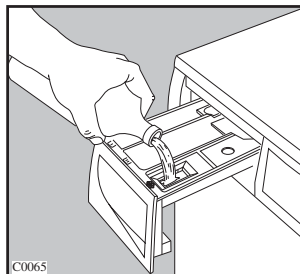
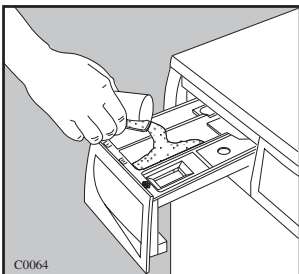

4. Switch the machine ON and OFF

Turn the selector dial to the desired programme to the switch appliance on. To switch the appliance off turn it to “Off”.

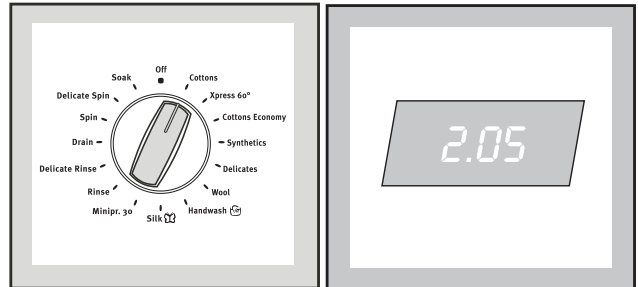

5. Select the desired programme

Turn the selector dial to the desired position: the LED corresponding to the different phases making up the selected programme illuminate.

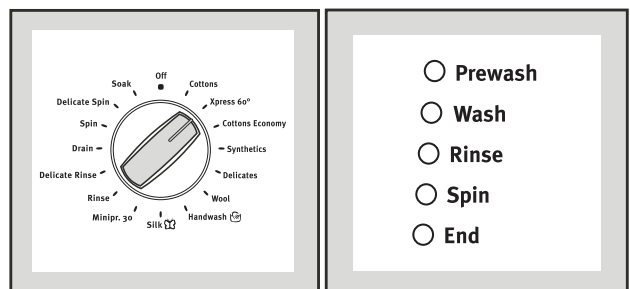

The duration of the programme appears in the display.

6. Select the temperature

Press the “Temp.” button if you wish to select a temperature value different from the one proposed by the washing machine. The relevant LED will light up.

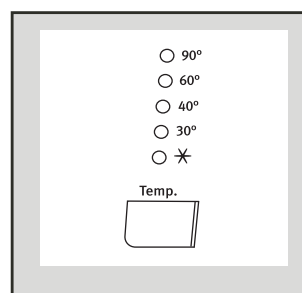

7. Select the spin speed or Rinse Hold Option

Press the “Spin” button repeatedly, in order to select the desired spin speed or the Rinse Hold  option. The relevant LED will light up.

If you select the Rinse Hold  option, the machine will stop at the end of the programme with the water still in the tub.

EWF 12108W

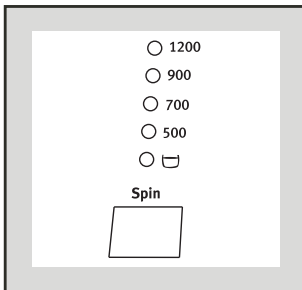

EWF 14108W

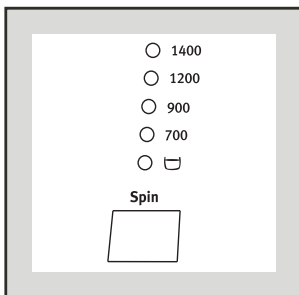

8. Select the desired option

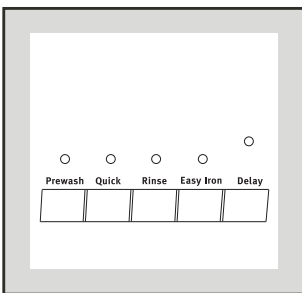

Press the relevant button to select the required options. Depending on the selected programme, only certain options are available and shown during the selection phase.

Note: Not all the options are compatible with each other. For the options that are not compatible, the icons will disappear.

9. Select the Delay Button

Before you start the programme if you wish the starting to be delayed, press the DELAY button. The figures corresponding to the selected delay will be displayed for about 3 seconds, after which the duration of the selected programme will appear on the display.

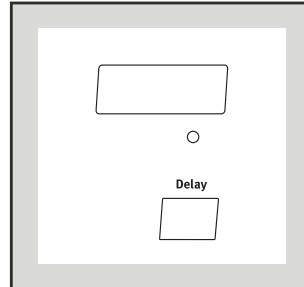

During this period it is possible to load other laundry:

- Press “Start” button;
- load the laundry;
- close the door and press “Start” button again.

10. Start the Programme

Press the “Start” button. The relevant LED will stop flashing, and only the LED relevant to the phase that is in progress will remain lit.

If you have chosen a delayed start, the washing machine will begin the countdown.

The display will show the duration of the programme or the selected delay.

11. How to change a programme during its cycle

You can alter the programme before it starts.

When the programme has started, you can only reset it by turning the programme selector dial to «Off» position and then you can select the new programme. Start it by pressing the “Start” button.

12. How to interrupt a programme during its cycle

Press the “Start” button to interrupt a programme which is running, the corresponding LED starts to flash. Press the same button again to restart the programme.

13. Cancelling a programme

Turn the selector dial to position «Off» to cancel a programme which is running. Now you can select a new programme.

14. How to open the door during the cycle of a programme

You can open the door, after having set the washing machine to PAUSE phase, by pressing “Start” button provided the following conditions exist:



- 1) the washing machine is not in the heating phase beyond 55°C
- 2) the level of the water is not high;
- 3) the drum is not turning.

After approximately 3 minutes, you can open the door.

Pay attention to the level and temperature of the water in the washing machine!

15. End of programme

The washing machine stops automatically at the end of the programme giving an audible signal.

If the Rinse hold  option has been selected, the LED of the “Start” button goes off, the LED  and the “End” LED remain lit to indicate that the water must be drained before opening the door. The display shows a flashing zero.

To empty out the water you can select programme “Drain”, the water is emptied out without spinning or select programme “Spin” or “Delicate Spin”. Select the spin speed by means of the relevant button and then press the “Start” button. The water is emptied out and the laundry is spun at the selected spin speed.

Turn the programme selector dial to position «Off» to switch the machine off.

Remove the laundry from the washing machine.

Check whether the drum is completely empty, by rotating it with your hand. The purpose of this is to prevent any items of laundry from remaining accidentally in the drum, where they might get damaged in a subsequent wash (e.g. by shrinking) or bleed colour into another load of laundry. We advise you to close the water supply tap and disconnect the plug from the socket. Leave the door ajar in order to air the washing machine.

Washing Hints

Do **NOT** overload the machine. Weigh the laundry the first few times you use the appliance.

The average weights of the most common items are listed below as a guide:

1000g = 1 kg

Sheet	700-1000 g
Pillow case	100-200 g
Tablecloth	400-500 g
Serviette	50-100 g
Tea towel	70-120 g
Linen hand towel	100-150 g
Towelling hand towel	150-250 g
Towelling bath towel	700-1000 g
Bath robe	1000-1500 g
Man's shirt	200-300 g
Apron	150-200 g

- Load the laundry loosely alternating large items with small ones.
- Sort the laundry according to the type of fabric, colour-fastness and how dirty it is.
- Avoid washing unhemmed or torn items as they may unravel.
- Before washing, empty all pockets of small objects which may have been left inside (coins, keys, screws etc.) as these could damage the drain pump.
- When washing curtains, remove the hooks.
- Close poppers and zips and fasten loose buttons.
- It is essential to wash new coloured items separately when washing for the first time.
- When washing fabrics requiring different wash temperatures together, always select the lowest temperature.
- White items should not be washed with coloured items.
- Very small items (handkerchiefs, ribbons, socks etc) should be washed in a washing bag or a pillow case.
- Use a good quality detergent suitable for automatic washing machines.
- Use the correct quantities of detergent.

- For wool, use gentle detergent only in small quantities.
- Bleach is very corrosive; it should be used with care and kept out of reach of children.
- Some stains such as fruit, wine, grass, rust etc. are difficult to remove and should be treated before washing with specific products, which can be found in most household shops. In some cases it may help to soak the stain before washing with a special pre-soak product or biological detergent.
- Only wool marked "Pure New Wool - washable, preshrunk" can be washed in the machine using the wool programme; other types of wool should be washed in Handwash programme.
- If you have used the machine to wash, rinse or spin only non-colour fast garments, there may be dye left in the sump. To ensure any subsequent wash is not contaminated with the dye, select and carry out a rinse and spin programme, without any garments, to ensure that any dye is removed from the sump.
- Once you have finished using the machine, you are advised to unplug it and turn off the water tap.

Which detergent?....

To ensure you obtain the best wash results from your appliance, it is important to use the right detergent in your everyday wash, and only detergents recommended for use in automatic machines.

To maintain the appearance of your clothes and household textiles and to make them last longer you should use different types of detergent for different washes, whether for whites, colours or delicates.

WHITES

We recommend the Ariel product range which is biological and designed to provide excellent cleaning and stain removal even at low temperatures.



NON BIOLOGICAL

If you prefer to use a non biological detergent, which does not contain enzymes we recommend Fairy. Fairy provides good cleaning and stain removal.



COLOURED

For coloured items you should use a detergent which is designed to clean while maintaining the original colour. Ariel Color does not contain bleach and therefore helps to preserve colours.



DELICATE ITEMS

When washing delicates such as woollens, you should use a product which is specially designed to care for fine fabrics.

Dreft Automatic is suitable for woollens and other delicates.



LAUNDRY BLEACH

For additional stain removal you may wish to use a product such as Ace Gentle Bleach which is used in addition to your chosen detergent. Ace is suitable for all washable fabrics including silks, woollens and coloureds.



And in which form?

Not only are there different types of detergent, but they are also available in different forms. Whether you chose a powder or liquid in traditional or compact form is your own personal choice.

TRADITIONAL POWDERS

Pour the powder directly into the dispenser drawer. Do not sprinkle powder onto clothes in the machine drum.

TRADITIONAL LIQUIDS

Liquid can be placed in the main wash compartment of the detergent drawer marked with the symbol , start the machine immediately upon placing the detergent in the dispenser drawer.

Alternatively the detergent is measured into the specially designed dosing device* which should be placed on top of the laundry, and at the back of the machine drum.

COMPACT POWDERS AND LIQUIDS

Compact detergents (or concentrates as they are also known) are available in liquid or powder form, and generally require a smaller dosage. Follow the manufacturer's instructions to ensure the most economical usage. Pour the detergent directly into the dispenser drawer, or alternatively measure the detergent into the specially designed dosing device* which should be placed on top of the laundry, and at the back of the machine drum.

* **If you use a dosing device in a washer dryer, please ensure the dosing device/ball is removed before carrying out a drying programme.**

FABRIC CONDITIONERS

These are ideal for improving 'softness', and also reduce static cling on synthetics and make ironing easier. They are available in two types:

For example Lenor liquid fabric softener, for use in the **washing machine/washer dryer**. The liquid fabric softener should be poured into the compartment marked with the symbol .

Follow the manufacturer's dosage instructions and never exceed the MAX level.



















Bounce conditioning sheets for use in a **tumble dryer**. We recommend the conditioning sheets are pinned (using a safety pin) to an article of laundry and placed in the tumble dryer.



Wash Care Symbols

Wash care labels inside garments recommend how to launder your clothes with the best results. The care labelling code is in line with care labelling used in the rest of Europe. The symbols used make it easy to select the correct programme on your washing machine.

WASHING SYMBOL	WASH ACTION	FABRIC
	Normal (Maximum)	White Cotton or Linen without Special Finishes
	Normal (Maximum)	Cotton, Linen or Viscose without Special Finishes Colourfast at 60°C.
	Reduced (Medium)	Nylon, Polyester/Cotton, Viscose with Special Finishes, Cotton/Acrylic Mix.
	Normal (Maximum)	Cotton, Linen or Viscose Colourfast at 40°C but not 60°C.
	Reduced (Medium)	Acrylics, Acetate, Triacetate, Wool mixes, Polyester/wool blends.
	Much Reduced (Minimum)	Wool, wool mixtures, Silks
	Hand wash only	Do not machine wash
BLEACHING		
	Chlorine bleach may be used	
IRONING		
	Hot iron	Cotton, Linen, Viscose
	Warm iron	Polyester mixtures, Wool
	Cool iron	Acrylic, Nylon, Polyester
DRY CLEANING		
	May be dry cleaned. Other letters and/or a bar beneath the circle will indicate the required process to the dry cleaner.	
TUMBLE DRYING		
	with high heat setting	
	with low heat setting	
	May be tumble dried	
	A cross through any symbol means «DO NOT»	

Important Notes

For best results, always use the dispenser drawer for dispensing detergents and liquid additives. Once the dispenser has been filled, close it by pushing it in gently. This is particularly important if

you are using fabric conditioner to avoid the conditioner entering the machine prematurely. When using liquid detergent and a prewash programme, place the detergent into the correct compartment in the dispenser drawer, after the prewash has finished.

Programme table

Washing Programmes

Wash programmes Fabrics	Type of Laundry	Description of Programme	Available options	Max. Load
Cottons	White and coloured cotton e.g Sheets, tablecloths, household linen	Main wash at - ✱ -90°C 3 rinses Long spin	Prewash Quick Rinse Easy Iron Rinse Hold	8 kg
Xpress60°	Coloured cotton e.g. shirts, blouses, towels and undergarments	Main wash at 60°C 3 rinses Long spin	Rinse Rinse Hold	4.5 kg
Cotton Economy*	Economy wash for whites or fast coloured cotton or linen fabrics, normally soiled shirts	Main wash at 40°C-60°C 3 rinses Long spin	Prewash Rinse Easy Iron Rinse Hold	4.5 kg
Synthetics	Coloured cotton or linen fabric, normally soiled shirts, blouses	Main wash at ✱ -60°C 3 rinses Long spin	Prewash Quick Rinse Easy Iron Rinse Hold	3.5 kg
Delicates	Synthetics or mixed fabric e.g lingerie, coloured garments	Main wash at ✱ -40°C 3 rinses Short spin	Prewash Quick Rinse Hold Rinse	3.5kg
Wool	Wool and Delicates	Main wash at ✱ -40°C 3 rinses Short spin	Rinse Hold	2 kg
Handwash	Delicate fabrics, Silk to be handwashed	Main wash at ✱ -40°C 3 rinses Short spin	Rinse Hold	2kg
Silk	Clothes labelled "Purenew wool, non-shrink machine washable" and silk fabric	Main wash at 30°C 3 rinses Short spin	Rinse Hold Rinse	1kg
Minipr.30	Special Programme for extremely delicate items.	Main wash at 30°C 3 rinses Short spin	Rinse Hold	4.5kg

*This programme at 60°C is the reference program for the energy label according to EEC directive 92/75

Programme table

Special Programmes

Wash programmes Fabrics	Type of Laundry	Description of Programme	Available options	Max. Load
Rinse	Silk fabrics	3 Rinses with liquid additives if required Long Spin at maximum speed	Rinse Hold Rinse Easy iron	8 kg
Delicate Rinse	Special Programme for extremely delicate items	3 Rinses with liquid additives if required Long Spin at maximum speed	Rinse Hold Easy Iron Rinse	8 kg
Drain	Seperate rinse cycle for handwashed cotton or linen items	Draining of water		8 kg
Spin	Seperate Spin for Cottons	Drain and Spin at maximum speed		8 kg
Delicate Spin	Seperate spin for delicate items	Drain and Spin at maximum speed		3.5kg
Soak	Seperate Soak programme for heavily soiled items	Soak		3.5 kg

Maintenance and Cleaning

Before any maintenance or cleaning is carried out you must **DISCONNECT** the appliance from the electricity supply.

Descaling

The water we use normally contains lime. It is a good idea to periodically use a water softening powder in the machine. Do this separately from any laundry washing, and according to the softening powder manufacturer's instructions. This will help to prevent the formation of lime deposits.

After each wash

Leave the door open for a while. This helps to prevent mould and stagnant smells forming inside the appliance. Keeping the door open after a wash will also help to preserve the door seal.

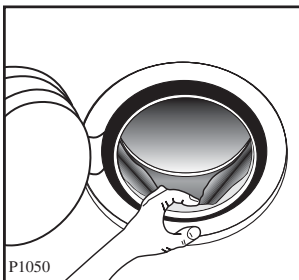

Maintenance Wash

With the use of low temperature washes it is possible to get a build up of residues inside the drum. We recommend that a maintenance wash be performed on a regular basis.

To run a maintenance wash:

- The drum should be empty of laundry.
- Select the hottest cotton wash programme.
- Use a normal measure of detergent, must be a powder (such as Ariel Futur).

External cleaning

Clean the exterior cabinet of the appliance with mild washing up liquid and water only, and then dry thoroughly.

Cleaning the dispenser drawer

The washing powder and additive dispenser drawer should be cleaned regularly.

Remove the drawer by pressing the catch downwards and by pulling it out. Flush it out under a tap, to remove any traces of accumulated powder. To aid cleaning, the top part of the additive compartment should be removed.

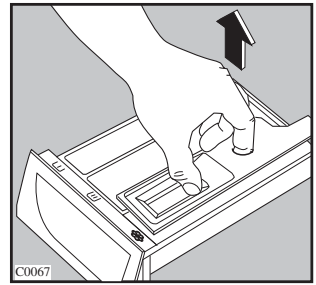
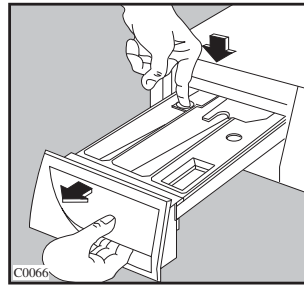

Cleaning the drawer recess

Having removed the drawer, use a small brush to clean the recess, ensuring that all washing powder residue is removed from the upper and lower part of the recess.

Replace the drawer and run the rinse programme without any clothes in the drum.

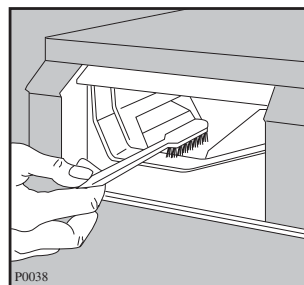

Cleaning the pump

The pump should be inspected regularly if

- the machine does not empty and/or spin
- the machine makes an unusual noise during draining due to objects such as safety pins, coins etc. blocking the pump.

Proceed as follows:

- Disconnect the appliance.
- If necessary wait until the water has cooled down.
- Open the pump door.

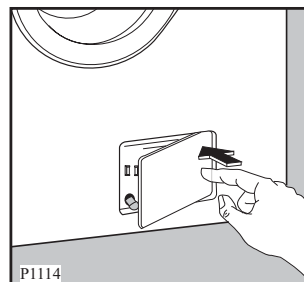

- Place a container close to the pump to collect any spillage.
- Pull out the emergency emptying hose, place it in the container and remove its cap.

- When no more water comes out, unscrew the pump cover and remove it. Always keep a rag nearby to dry up spillage of water when removing the cover.

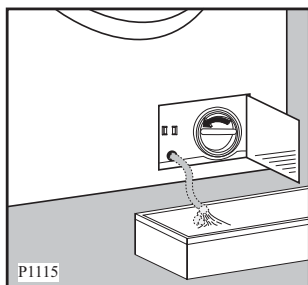

- Remove any objects from the pump impeller by rotating it.

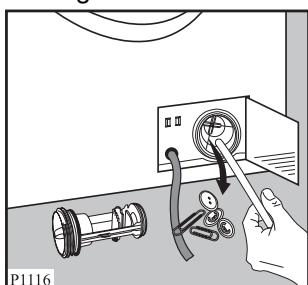

- Put the cap back on the emergency emptying hose and place the latter back in its seat.

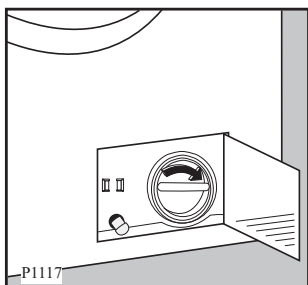

- Screw the pump cover fully in.
- Close the pump door.

Warning

When the appliance is in use and depending on the programme selected there can be hot water in the pump. Never remove the pump cover during a wash cycle, always wait until the appliance has finished the cycle, and is empty. When replacing the cover, ensure it is securely retightened so as to stop leaks and young children being able to remove it.

Cleaning the water inlet filter

If your water is very hard or contains traces of lime deposit, the water inlet filter may become clogged. It is therefore a good idea to clean it from time to time.

Turn off the water tap. Unscrew the water inlet hose. Clean the filter using a hard bristle brush. Tighten up the inlet hose.

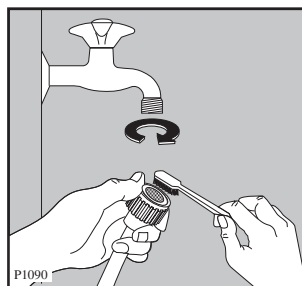

The dangers of freezing

If the machine is exposed to temperatures below 0°C, certain precautions should be taken.

- Turn off the water tap.
- Unscrew the inlet hose.
- Place the end of the emergency emptying hose and that of the inlet hose in a bowl placed on the floor and let water drain out.
- Screw the water inlet hose back on and reposition the emergency emptying hose after having put the cap on again.
- When you intend to start the machine again, make sure that the room temperature is above 0°C.

Important!

Every time you drain the water through the emergency emptying hose you must pour 2 litres of water into the main wash compartment of the detergent drawer and then run the drain programme. This will activate the ECO valve and avoid the detergent remains being wasted.

Emergency emptying out

If the water is not discharged, proceed as follows to empty out the machine:

- pull out the plug from the power socket;
- close the water tap;
- if necessary, wait until the water has cooled down;
- open the pump door;
- place a bowl on the floor and place the end of the emergency emptying hose into the bowl. Remove its cap. The water should drain by gravity into the bowl. When the bowl is full, put the cap back on the hose. Empty the bowl. Repeat the procedure until water stops flowing out;
- clean the pump if necessary as previously described;
- replace the emergency emptying hose in its seat after having plugged it;
- screw the pump cover again and close the door.

Something not working?

Certain problems are due to lack of simple maintenance or oversights, which can be solved easily without calling out an engineer. Before contacting your local Service Force Centre, please carry out the checks listed below.

IMPORTANT: if you call out an engineer to a fault listed below, or to repair a fault caused by incorrect use or installation, a charge will be made even if the appliance is under guarantee.

During machine operation it is possible that one of the following alarm codes appears on the display and the "End" light starts to flash:

- **E10** : problem with the water supply
- **E20** : problem with water draining
- **E40** : door open

Once the problem has been eliminated, press the START button to restart the programme. If after all checks, the problem persists, contact your local Service Force Centre.

Problem	Possible causes
The machine does not start	<ul style="list-style-type: none"> • The door has not been closed. (E40) • The plug is not properly inserted in the power socket. • There is no supply at the socket. • The main fuse or the fuse in the plug has blown. • The Start button has not been pressed. • The DELAY has been selected.
The machine does not fill	<ul style="list-style-type: none"> • The water tap is closed. (E10) • The filter in the inlet hose is blocked. (E10) • The inlet hose may be squashed or kinked. (E10) • The door has not been closed. (E40)
The machine fills then empties immediately	<ul style="list-style-type: none"> • The end of the drain hose is too low. • The end of the drain hose is submerged in water. • There is no vent in the end of the drain hose.
The machine does not empty and/or does not spin	<ul style="list-style-type: none"> • The drain hose may be squashed or kinked. (E20) • The option  has been selected. • The drain pump may be blocked. (E20) • The drain hose extension, if fitted, is not correct. Follow the instructions for connecting to the waste. • The drainage system pipes are blocked. • The wash load is unbalanced: redistribute the clothes inside the drum to allow the machine to spin.
There is water on the floor	<ul style="list-style-type: none"> • Too much detergent or unsuitable detergent has been used (creates too much foam). • Check whether there are any leaks from the inlet hose fittings. It is not always easy to see this as the water runs down the hose; check to see if it is damp. • The drain hose may be damaged or not securely positioned. • The detergent dispenser drawer or recess is clogged. • The drainage system pipes are blocked. • The cap on the emergency emptying hose has not been replaced after cleaning the pump.

Problem	Possible causes
Unsatisfactory washing results:	<ul style="list-style-type: none"> • Too little detergent or unsuitable detergent has been used. • Stubborn stains have not been treated prior to washing. • The correct temperature was not selected. • Excessive laundry load.
The machine vibrates or is noisy:	<ul style="list-style-type: none"> • The transit bolts and packing have not been removed. • The support feet have not been adjusted. • The laundry is not evenly distributed in the drum. • Maybe there is very little laundry in the drum.
The door will not open:	<ul style="list-style-type: none"> • The programme is still running. • The door lock has not been released. • There is water in the drum. <p>The door could be opened only when «Door openable» message appears in the display and the door locked light goes off.</p>
Spinning starts late or the machine does not spin:	<ul style="list-style-type: none"> • The electronic unbalance detection device has cut in because the laundry is not evenly distributed in the drum. The laundry is redistributed by reverse rotation of the drum. This may happen several times before the unbalance disappears and normal spinning can resume. If, after 10 minutes, the laundry is still not evenly distributed in the drum, the machine will not spin. In this case, redistribute the load manually and select the spin programme.

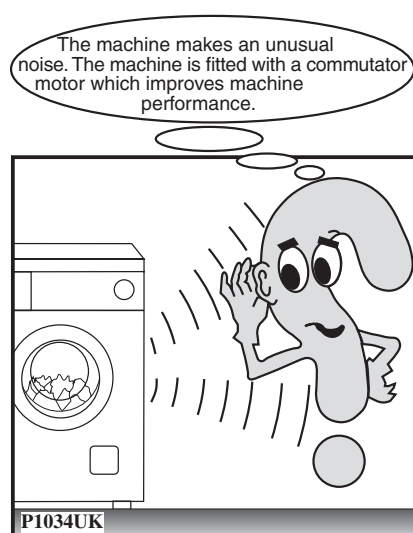
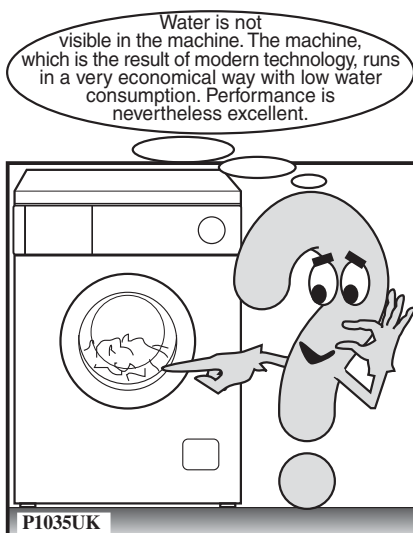

Service & Spare Parts

In the event of your appliance requiring service, or if you wish to purchase spare parts, please contact your local Electrolux Service Force Centre by telephoning:

0870 5 929929

Your telephone call will be automatically routed to the Service Force Centre covering your post code area.

For the address of your local Electrolux Service Force Centre and further information about Service Force, please visit the website at www.serviceforce.co.uk.

For Customer Service in Ireland please contact us at the address below:

Electrolux

Electrolux Group (Irl) Ltd

Long Mile Road

Dublin 12

Republic of Ireland

Tel: +353 (0)1 4090751

Email: service.eid@electrolux.ie

Before calling out an engineer, please ensure you have read the details under the heading "Something Not Working".

When you contact the Service Force Centre you will need to give the following details:

1. Your name, address and post code
2. Your telephone number
3. Clear and concise details of fault
4. The model and serial number of the appliance (found on the rating plate - see picture)
5. The purchase date.

Please note that a valid purchase receipt or guarantee documentation is required for in-guarantee service calls.

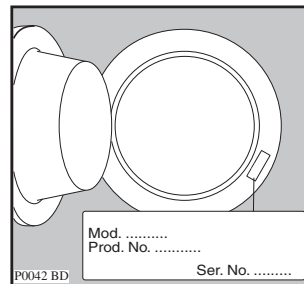

Customer Care Department

For general enquiries concerning your Electrolux appliance or for further information on Electrolux products, please contact our Customer Care Department by letter or telephone as follows :

Electrolux

Customer Care Department (Major Appliances)

Addington Way

Luton

Bedfordshire

LU4 9QQ

Tel 08705 950950*

or visit our website at : www.electrolux.co.uk

* calls to this number may be recorded for training purposes.

Guarantee Conditions

Standard guarantee conditions

We, Electrolux, undertake that if, within 12 months of the date of the purchase, this ELECTROLUX appliance or any part thereof is proved to be defective by reason only of faulty workmanship or materials, we will, at our option repair or replace the same FREE OF ANY CHARGE for labour, materials or carriage on condition that:

- The appliance has been correctly installed and used only on the electricity supply stated on the rating plate.
- The appliance has been used for normal domestic purposes only, and in accordance with the manufacturer's instructions.
- The appliance has not been serviced, maintained, repaired, taken apart or tampered with, by any person not authorised by us.
- All service work under this guarantee must be undertaken by Electrolux Service Force Centre.
- Any appliance or defective part replaced shall become the Company's property.
- This guarantee is in addition to your statutory and other legal rights.

Home visits are made between **8.30am** and **5.30pm** Monday to Friday. Visits may be available outside these hours in which case a **premium** will be charged.

Exclusions

This guarantee does not cover:

- Damage or calls resulting from transportation, improper use or neglect, the replacement of any light bulbs or removable parts of glass or plastic.
- Costs incurred for calls to put right an appliance which is improperly installed or calls to appliances outside the United Kingdom.
- Appliances found to be in use within a commercial environment, plus those which are subject to rental agreements.
- Products of Electrolux manufacture which are NOT marketed by Electrolux.

European guarantee





If you should move to another country within Europe then your guarantee moves with you to your new home subject to the following qualifications:

- The guarantee starts from the date you first purchased your product.
- The guarantee is for the same period and to the same extent for labour and parts as exists in the new country of use for this brand or range of products.
- The guarantee relates to you and cannot be transferred to another user.
- Your new home is within the European Community (EC) or European Free Trade Area.
- The product is installed and used in accordance with our instructions and is only used domestically, i.e. a normal household.
- The product is installed taking into account regulations in your new country.

Before you move please contact your nearest Customer Care Centre, listed below, to give them details of your new home. They will then ensure that the local Service Organisation is aware of your move and able to look after you and your appliances.

France	Senlis	+33 (0)344 62 29 29
Germany	Nurnberg	+49 (0)800 234 7378
Italy	Pordenone	+39 (0)434 39 47 00
Sweden	Stockholm	+46 (0)8 672 53 90
UK	Luton	+44 (0)8705 950950

Installation Instructions

-  It is dangerous to alter the specifications or attempt to modify this product in any way.
-  Care must be taken to ensure that the appliance does not stand on the electrical supply cable.
-  Any electrical work required to install this appliance should be carried out by a qualified electrician or competent person.
-  Any plumbing work required to install this appliance should be carried out by a qualified plumber or competent person.
-  Should the appliance power supply cable need to be replaced, this should be carried out by our Service Force Centre.

Technical Specifications

DIMENSIONS		EWF 12108W	EWF 14108W
	Height	85 cm	85 cm
	Width	60 cm	60 cm
	Depth	60 cm	60 cm
MAXIMUM LOAD	Cotton	8 kg	8 kg
	Synthetics	3.5 kg	3.5 kg
	Delicates	3.5 kg	3.5 kg
	Woollens	2 kg	2 kg
	Handwash	2 kg	2 kg
	Silk	1 kg	1 kg
SPIN SPEED max		1200 rpm	1400 rpm
POWER SUPPLY VOLTAGE/FREQUENCY		230-240V / 50HZ	230-240V / 50HZ
TOTAL POWER ABSORBED		2200W	2200W
MINIMUM FUSE PROTECTION		10A	10A
WATER PRESSURE	Minimum	50kPa	50kPa
	Maximum	800kPa	800kPa
CONSUMPTION DATA FOR WASHING 5 KG NORMALLY SOILED COTTON	Energy	1.52 kWh	1.52 kWh
	Water	60 litres	60 litres

 This appliance complies with the following EEC Directives:
 73/23/EEC of 19/02/73 relating to low voltage
 89/336/EEC of 03/05/89 relating to electromagnetic compatibility.

Unpacking

 All transit bolts and packing must be removed before using the appliance.

You are advised to keep all transit devices so that they can be refitted if the machine ever has to be transported again.

- Using a spanner, unscrew and remove the two rear bottom screws. Slide out the two plastic pins. Lay the machine on its back, taking care not to squash the hoses. This can be avoided by placing one of the corner packing pieces between the machine and the floor

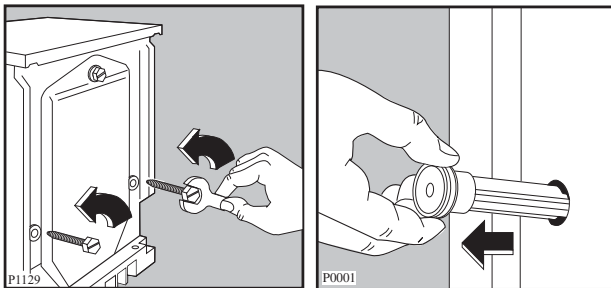

- Remove the polystyrene block(s) from the bottom of the machine and release the two plastic bags.
- Very carefully slide out the left polythene bag, removing it towards the right and then

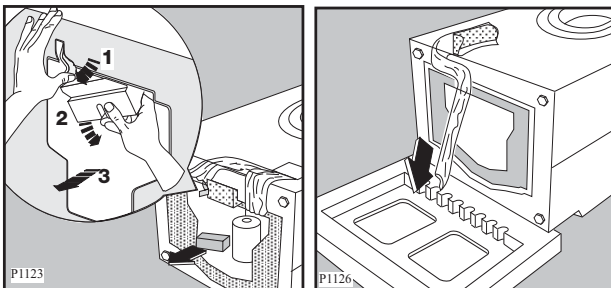

downwards.

- Very carefully slide out the right polythene bag, removing it towards the left and then upwards. Remove the bottom cover found inside the drum of your appliance, lay it's hook as the arrow 'A' indicates and push the top of the cover to seal it closed

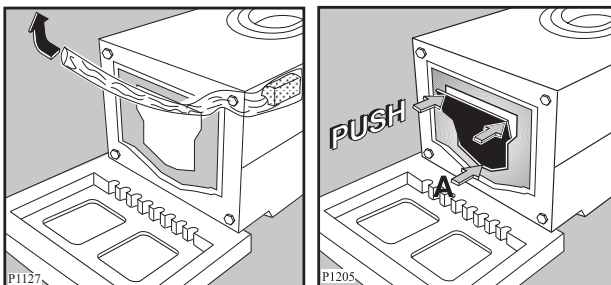

Important: You can find more detailed instructions regarding the bottom cover assembling in it's relative bag.

- Set the machine upright and remove the remaining rear screw. Slide out the relevant pin.
- Plug all the holes with the plugs which you will find in the envelope containing the instruction manual.

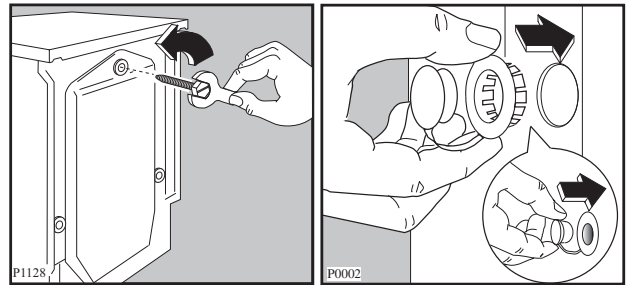

Important !

You are advised to keep all the packaging for re-use in case the machine is to be transported again. In case of moving out the same precautions as per paragraphe "The dangers of freezing" must be taken i.e. the residual water in the hoses must be pumped out.

Positioning

Install the machine on a flat hard floor. Make sure that air circulation around the machine is not impeded by carpets, rugs etc. Check that the machine does not touch the wall or other kitchen units.

Never place cardboard, wood or similar materials under the machine to compensate for any unevenness in the floor.

Your new washing machine has been designed to be permanently plumbed in to your home's water supply and drainage system. However, if this is not possible, it may be connected to suitable existing tap with the drain hose discharging into a sink.

The appliance has one inlet hose, with female 3/4" BSP thread connector. If this connection is not compatible with the plumbing of the existing installation, a variety of connectors are available from good hardware stores and plumbers merchants to suit most domestic plumbing. Any alteration to your existing plumbing must be carried out by a competent person, or qualified plumber.

Installation on a Suspended Floor

Suspended wooden floors are particularly susceptible to vibration. To help prevent vibration we recommend you place a waterproof wood panel, at least 15 mm thick under the appliance, secured to at least 2 floor beams with screws. If possible install the appliance in one of the corners of the room, where the floor is more stable.

Water inlet

Connect the hose to a tap with a 3/4" thread. Do not use previously used hoses for water connection.

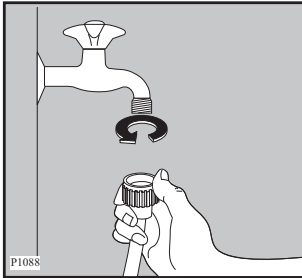

Installation should comply with local water authority and building regulations' requirements.

The appliance must be connected to a cold water supply.

A minimum water pressure of 0.05 MPa (0.5 bar) is required for safe operation of the appliance.

If you cannot make the cold water connection direct from the rising mains, you may be able to operate the appliance from your cold water storage system.

There should be a minimum distance of 5.02m (16.5 ft) between the appliance's inlet and the bottom of the water storage tank.

Set the hose correctly by loosening the ring nut. After positioning the inlet hose, be sure to tighten the ring nut again to prevent leaks.

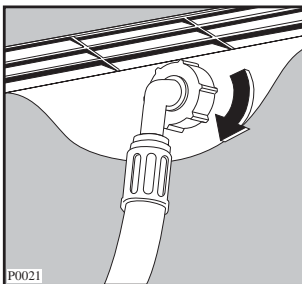

Water drainage

This appliance is designed to be permanently plumbed into your home's drainage system using one of the following methods.

1. Into a drainage standpipe.

Firstly form a hook in the end of the drain hose using the "U" piece supplied.

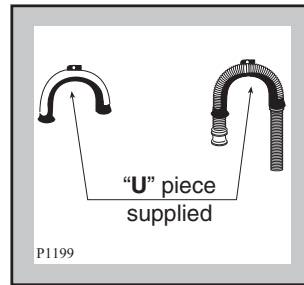

Place the drain hose into your standpipe, which should have an internal diameter of approximately 38mm thus ensuring there is an air break between the drain hose and standpipe.

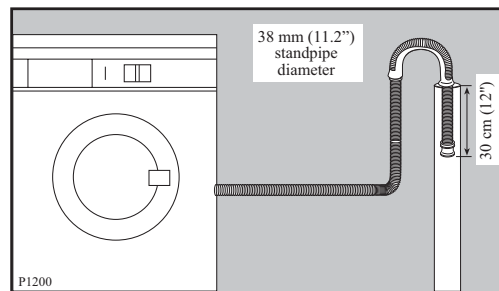

When discharging into a standpipe ensure that the top of the standpipe is no more than 90cm (35.4") and no less than 60cm (23.6") above floor level.

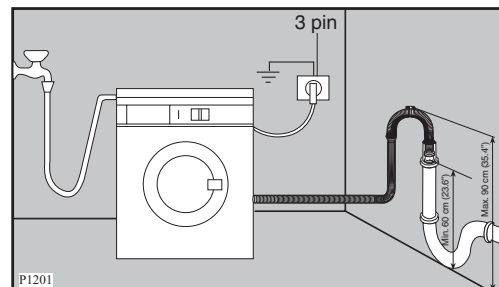

The drain hose may be extended to a maximum of 4 metres. An additional drain hose and joining piece is available from your local Service Force Centre. The joining piece must have an internal diameter of 18mm.

If your drain hose looks like this (see below) you do not require the "U" piece". Just push the hose firmly into the standpipe.

2. Onto a sink outlet spigot.

If the outlet spigot has not been used before, remove any blanking plug that may be in place.

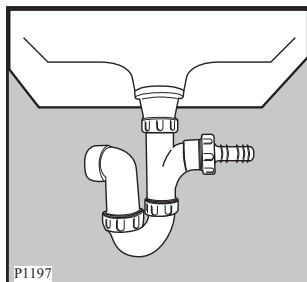

Push the drain hose onto the spigot and secure with a clip if required, ensure a loop is formed in the drain hose (see diagram) to prevent waste from the sink entering the washing machine.

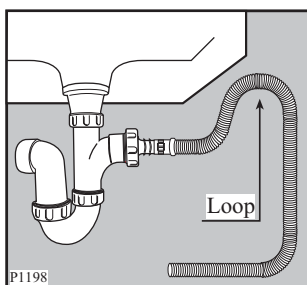

The drain hose may be extended to a maximum of 4 metres. An additional drain hose and joining piece is available from your local Service Force Centre. The joining piece must have an internal diameter of 18mm.

Important

- Before connecting the machine to new pipework or to pipework that has not been used for some time, run off a reasonable amount of water to flush out any debris that may have collected in the pipes.
- For the correct functioning of the machine the drain hose must be hooked on the proper support piece situated on the top of the back side of the appliance.

Levelling

Level the washing machine by raising or lowering the feet.

The feet may be tight to adjust as they incorporate a self locking nut, but the machine **MUST** be level and stable.

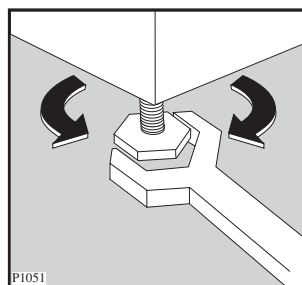

Any necessary adjustment can be made with a spanner. Accurate levelling prevents vibration, noise and displacement of the machine during operation.

Some vibration is inevitable, especially if mounted on a wooden floor.

Sprung wooden floors are particularly susceptible to vibration. For advice, consult a builder. If possible, always place the machine on a solid floor.

Special conditions

If the floor is carpeted or covered with crumbly or soft material, insert a rigid support base under the feet to prevent noise, vibration or displacement. The base should protrude a few centimetres beyond the edges of the machine.



Warning

The machine should **NOT** be placed on deep pile carpeting.

Note

Please ensure that when the appliance is installed it is easily accessible for the engineer in the event of a breakdown.

In the interest of the environment

Washing machines and dishwashers should be connected to the FOUL drainage system, the water will then be taken to a sewage works for treatment before being discharged safely into a river. It is essential that these appliances are not connected to the surface water drainage system as this water is discharged directly into a river or stream and may cause pollution.

If you require any further advice please contact your local water authority.

Electrical connection

Any electrical work required to install this appliance should be carried out by a qualified electrician or competent person.

! WARNING: THIS APPLIANCE MUST BE EARTHED.

The manufacturer declines any liability should this safety measure not be observed.

Before switching on, make sure the electricity supply voltage is the same as that indicated on the appliance's rating plate. The rating plate is located at the bottom of the rim of the open door.

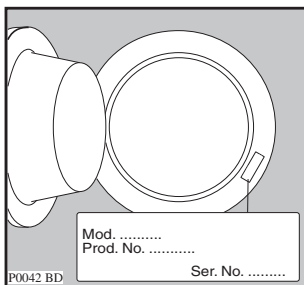

The appliance is supplied with a 13amp plug fitted. In the event of having to change the fuse in the plug supplied, a 13amp ASTA approved (BS 1363/A) fuse must be used. Should the plug need to be replaced for any reason, proceed as described below.

The wires in the mains lead are coloured in accordance with the following code:

Green and Yellow - Earth
Blue - Neutral
Brown - Live

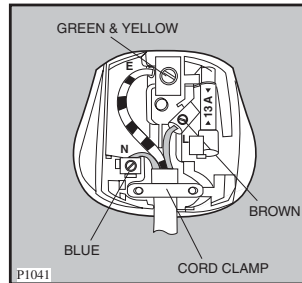

The wire coloured green and yellow must be connected to the terminal marked with the letter «E» or by the earth symbol \perp or coloured green and yellow.

The wire coloured blue must be connected to the terminal marked «N» or coloured black.

The wire coloured brown must be connected to the terminal marked «L» or coloured red.

Upon completion there must be no cut, or stray strands of wire present and the cord clamp must be secure over the outer sheath.

! WARNING:
A cut off plug inserted into a 13 amp socket is a serious safety (shock) hazard. Ensure that the cut off plug is disposed of safely.

Should the appliance power supply cable need to be replaced, this must be carried out by our Service Force Centre.

Note

When the appliance is installed the power supply cable must be accessible.

Permanent connection

In the case of permanent connection it is necessary that you install a double pole switch between the appliance and the electricity supply (mains), with a minimum gap of 3mm between the switch contacts and of a type suitable for the required load in compliance with the current electrical regulations.

The switch must not break the yellow and green earth cable at any point.

Electrolux

 **The Electrolux Group.** *The world's No. 1 choice.*

The Electrolux Group is the world's largest producer of powered appliances for kitchen, cleaning and outdoor use. More than 55 million Electrolux Group products (such as refrigerators, cookers, washing machines, vacuum cleaners, chain saws and lawn mowers) are sold each year to a value of approx. USD 14 billion in more than 150 countries around the world.