

MICROMAT 625

MICROWAVE OVEN

Operating Instructions

**Please read these operating instructions carefully
before using the oven and keep for future reference**

GB

Contents	Page
Features	22
Before you read on	23
Golden rules, Using your microwave oven	23/24
How to cook by time and power	25
General hints on cooking, heating, and defrosting	25
Holding time	25
Hints on power setting in %	25
Practical hints on working with microwave appliances	26
First use, setting cooking time and power, starting	28
Correction, interruption, cancellation, requesting	30
Cooking with time and power in 3 settings	32
Manual defrosting	32
Automatic defrosting	32
Short-term alarm	32
Table for defrosting of poultry/meat with automatic defrosting system	33
The correct ovenware	34
Special browning skillet	34
Cleaning and care	35
Changing the lighting	35
If you think your microwave oven is not functioning properly	36
Questions and answers	36
Installing and connecting the table-top appliance	37
Rating plate	37
Technical data	38
Data for test centres	38

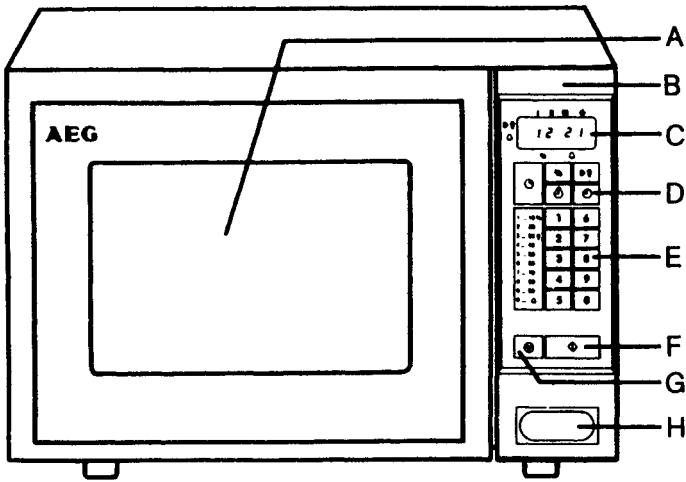

MC 1

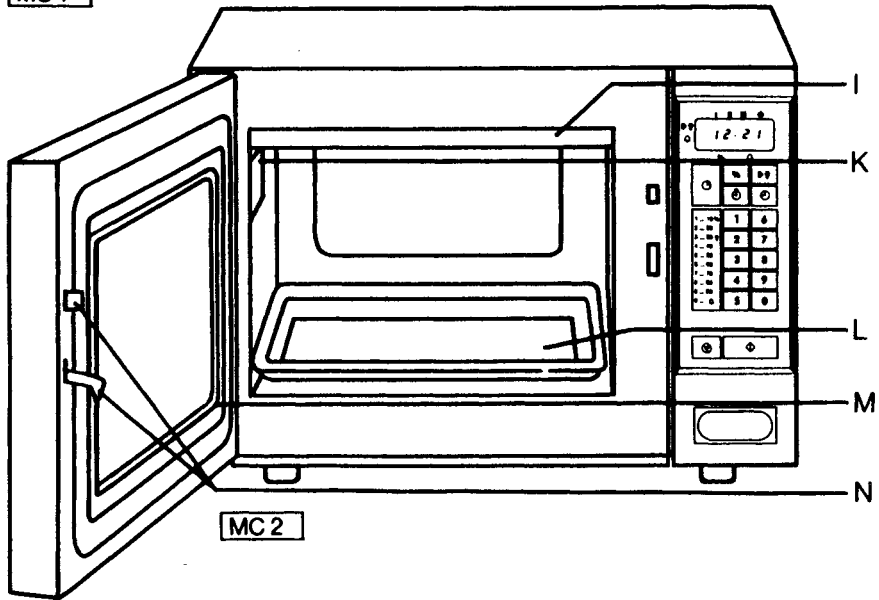

MC 2

Features

- | | |
|--------------------------|--|
| A See-through glass door | H Door opener |
| B Control panel | I Wave stirrer cover |
| C Display window | K Cooking space lighting, externally replaceable |
| D Function buttons | L Glass dish (must be in the oven when the latter is operating) |
| E Entry buttons | M Door seal |
| F Start button | N Door catch and safety device |
| G Correction button | |

Before you read on

Please read these Operating Instructions thoroughly before using your appliance. You will learn how to operate a microwave oven, how to set cooking time and power, and how to clean and maintain a microwave oven.

Microwaves – what are they?

Microwaves are high-frequency electromagnetic waves similar to daylight or radio waves.

They are emitted inside your appliance and converted into heat when they reach the food.

The golden rules for trouble-free and safe working with microwave appliances

1. Switch on the microwave oven only when food has been placed in the cooking space.
2. Always keep your microwave oven clean, especially in the vicinity of the door seals and door seal surfaces.
3. **Never damage:**
 - the door
 - the door hinges
 - the door seals and their surfaces
 - the door frame

(e. g. never jam anything between door and frame).

Clean the door seals and their surfaces (also the door frame) with a mild detergent and hot water.

Note:

Should the door seals and door seal surfaces be damaged, the cooker should not be operated until it has been repaired by the AEG Service Centre or by an AEG-trained electrician!

4. **Only use suitable ovenware.**
You will find instructions on page 34.

The golden rules for trouble-free and safe working with microwave appliances

5. When heating liquids, please always additionally place a teaspoon in the container to avoid boiling. During delayed boiling, the boiling temperature is attained without typical steam bubbles rising. Even when the container is only slightly shaken, the liquid may then suddenly vigorously boil over or spurt. Risk of scalding.
6. Food with a "skin" or "peel", such as potatoes, tomatoes, sausages, and the like should be pierced with a fork so that any steam present can escape and the food will not burst.
7. Babyfood in jars or bottles should basically be heated without a lid or top and well stirred or shaken after heating to ensure uniform distribution of the heat. Before giving your child the babyfood, please check the temperature.
8. Please note that, at high power and time settings, the ovenware heats up. Therefore use protective mittens suitable for handling hot pans.
9. **Never use your microwave oven:**
 - to boil eggs in their shells, since they will otherwise burst!
 - to heat large quantities of cooking oil (fondue, deep-frying) and drinks containing a high percentage of alcohol (danger of spontaneous combustion!)
 - to heat unopened cans, bottles, etc.
 - to dry animals, textiles, and paper
 - if no food has been placed in the cooking space.
10. **Use your appliance only as instructed** by the manufacturer and as indicated in the "Cooking tables" booklet provided. Never overcook your food by excessive times and excessive power settings. Specific areas of the food will otherwise dry out and may ignite.
11. **Only operate your appliance when the glass dish is inserted (Fig. MC 2).**

AEG electrical appliances comply with the valid safety requirements. Never use your microwave oven if it no longer operates in a trouble-free manner.

To ensure the safety of your appliance, you should have repairs, especially on live parts, carried out only by AEG-trained electricians. In the event of a fault, you must therefore contact your retailer or our service centre direct.

Improper repairs may place the user at serious risk.

Exception: Changing the cooking space lighting (page 35).

How to cook by time and power

To familiarize yourself easily and quickly with operation of your microwave oven, please use the "Cooking tables" booklet provided.

The cooking time depends on the quantity of food. For example, one cup of soup is ready to eat in around 1.5–2 minutes. Five cups of soup take around 5 times as long, i. e. around 7–10 minutes.

You will find the exact times in the "Cooking tables" booklet provided.

General hints on cooking, heating, and defrosting

Food comes in different qualities and is prepared in different quantities.

The times and amounts of energy necessary for defrosting, heating, or cooking are therefore different.

In the "Cooking tables" booklet provided, you will find information on what setting of time and power you should individually select.

Holding time

The standing time referred to in the "Cooking tables" booklet means that you should allow the food to stand without power e. g. inside or outside the appliance.

Hints on power setting in %

Power %	Power settings
100 %	Full power, cooking, heating
60–90 %	Cooking of tender food
40–50 %	Fast defrosting of small portions, cooking, heating
30 % $\frac{2}{3}$	Slow defrosting, warming
10–20 %	Warming, heating of tender food

Practical hints on working with microwave appliances

Cooking:

Wherever possible, cook in a covered container. Only if crust is required or is to be retained should you cook food in uncovered containers. After switching off your appliance, allow the food to stand inside for some minutes (holding time).

Refrigerated or frozen foods require a longer cooking time.

Foods containing sauces should be stirred from time to time.

Meat:

Cook fatty pieces of meat (e. g. pork), game, or poultry on a non-metallic grid or inverted saucer. Cook leaner meat types in a browning skillet (special accessory). Turn during the **cooking period**.

Vegetables:

Always cook vegetables in a covered container and stir them from time to time. Cook vegetables with firm consistency, such as carrots, peas, and cauliflower, with a little water. Cook vegetables with soft consistency, such as mushrooms, peppers, and tomatoes, without liquid.

Do not defrost deep-frozen vegetables before cooking, but defrost and cook in one process.

Defrosting:

Meat:

Place frozen, unpacked meat on an inverted plate in a glass or porcelain container so that the meat juice can drain. Turn during the defrosting period. Possibly cover already defrosted areas with small sheets of aluminium foil. Keep sheets of foil at least 2 cm away from the cooking space walls and door.

When the defrosting period has elapsed, the pieces of meat need a differently long holding time depending on consistency.

Butter, pieces of layer cake, cottage cheese:

Previously remove aluminium foil packaging. Do not fully defrost in the appliance, but leave to adjust outside (e. g. for cottage cheese and pieces of layer cake, 30 min-1 h depending on quantity).

Fruit:

Carefully turn or stir during the defrosting period.

Convenience foods:

Convenience foods in metal packages or plastic containers with metal lids should be heated or defrosted in your microwave oven only if they are explicitly marked as being suitable for microwave use.

Please follow the operating instructions printed on the packages.

Important: Metal objects must be placed at least 2 cm away from the cooking space walls and door.

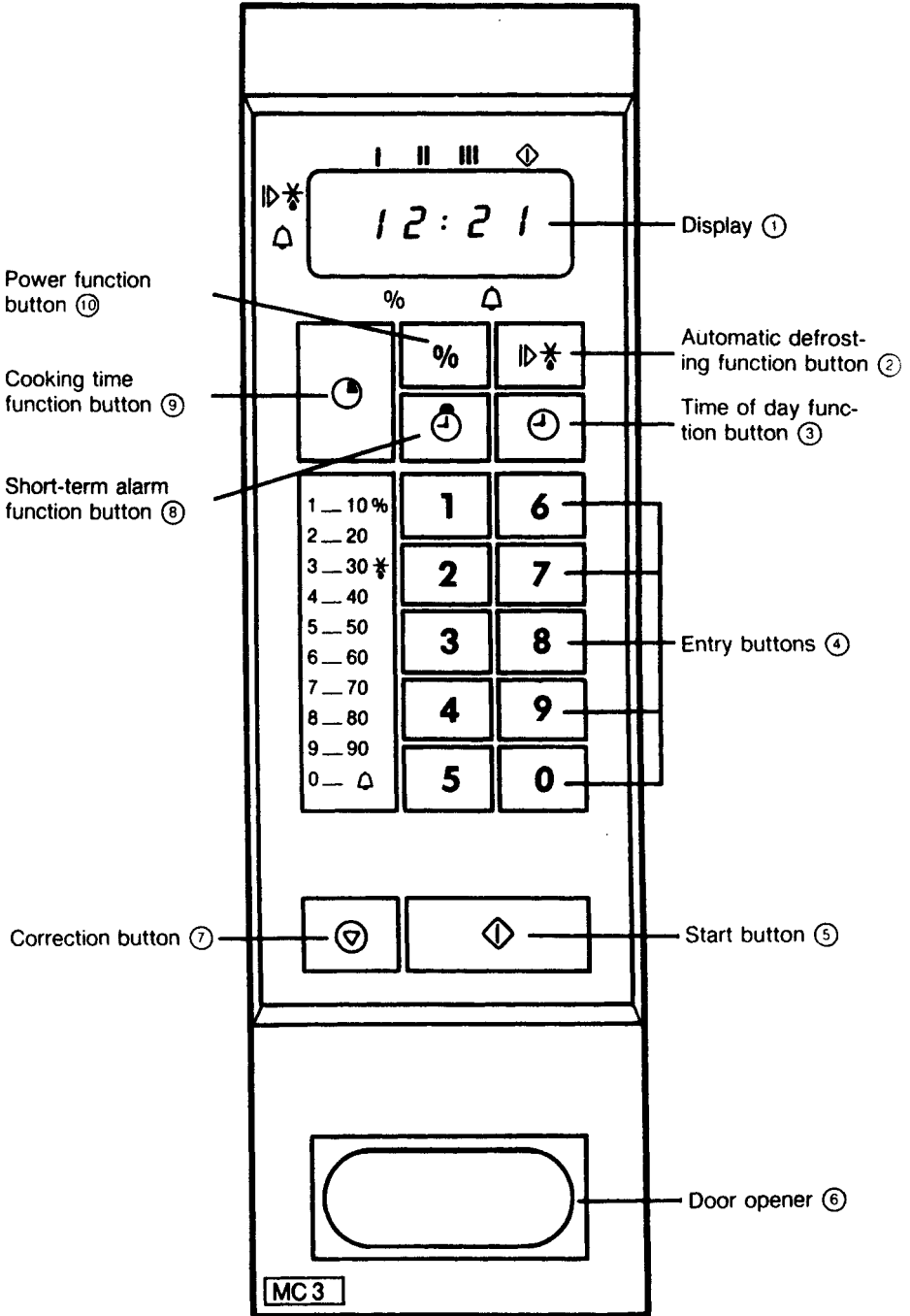

First use, setting cooking time and power, starting

Setting the time of day

Place mains plug in plug socket with protective earth contact. 0:0 appears in **display** ①.

Enter the time of day with **entry buttons** ④ 0–9.

Press the **time of day button** ③ ④.

Display ① indicates the block time, e. g. 12.00.

Only now is your microwave oven ready to operate.

Correcting the time of day

Press the **time of day button** ③ ④ twice. Enter the new time of day.

Press the **time of day button** ③ ④.

The **display** ① indicates the new, corrected time of day, e. g. 12.10.

Cooking time and power

Never operate your microwave oven when it is empty!

Cooking by time at 100 % power

Press the **cooking time button** ⑨ ⑩ and enter the **cooking time with the entry buttons** ④ 0–9.

Press the **start button** ⑤ ⏩. Your microwave oven now operates at the highest power of 100 %.

In the **display** ①, the cooking time visibly elapses, counting backwards.

Program end/switching off

An audible signal sounds at the end of the cooking sequence. By pressing the door opener button ⑥ or the cooking time button ⑨ ⑩, this signal can be switched off.

The time of day appears in the display window ①.

Cooking by time and variable power (10–90 %)

Press the **cooking time button** ⑨ ⑩ and enter the cooking time with the entry buttons ④ 0–9.

Press the **power button** ⑩ % and enter the power with the entry buttons ④ 0–9.

Press the **start button** ⑤ ⏩.

In the **display** ①, the elapsing cooking time appears on the right and the power intermittently **every 10 seconds** on the left.

Program end/switching off



An audible signal sounds at the end of the cooking sequence. The time of day reappears in the **display** ①.

By pressing the **door opener button** ⑥ or the **cooking time button** ⑨ ⑩, this signal can be switched off.

Correction, interruption, cancellation, requesting

Correcting the cooking time and power



Start button   not yet pressed



Press the **correction button**   and change the cooking time or power

Then press the **start button**   to reset

Interrupting the cooking sequence/switching off



All cooking sequences can be interrupted by opening the door with the **door opener** .
e.g. for stirring (cooking time/power remains stored)

To continue cooking, press the **start button**   after closing the door. The cooking time automatically resumes

If you do not want to continue cooking, the remaining time can be cancelled by pressing the **correction button**  . The time of day appears

Cancelling all entries

Start button   already pressed.

By pressing the **correction button**   twice, all sequences can be cancelled

Requesting (cooking time, short-term alarm, automatic defrosting system)

During the cooking sequence, the individual values can be retrieved for checking by pressing the individual buttons

When the button is released, the elapsing time reappears

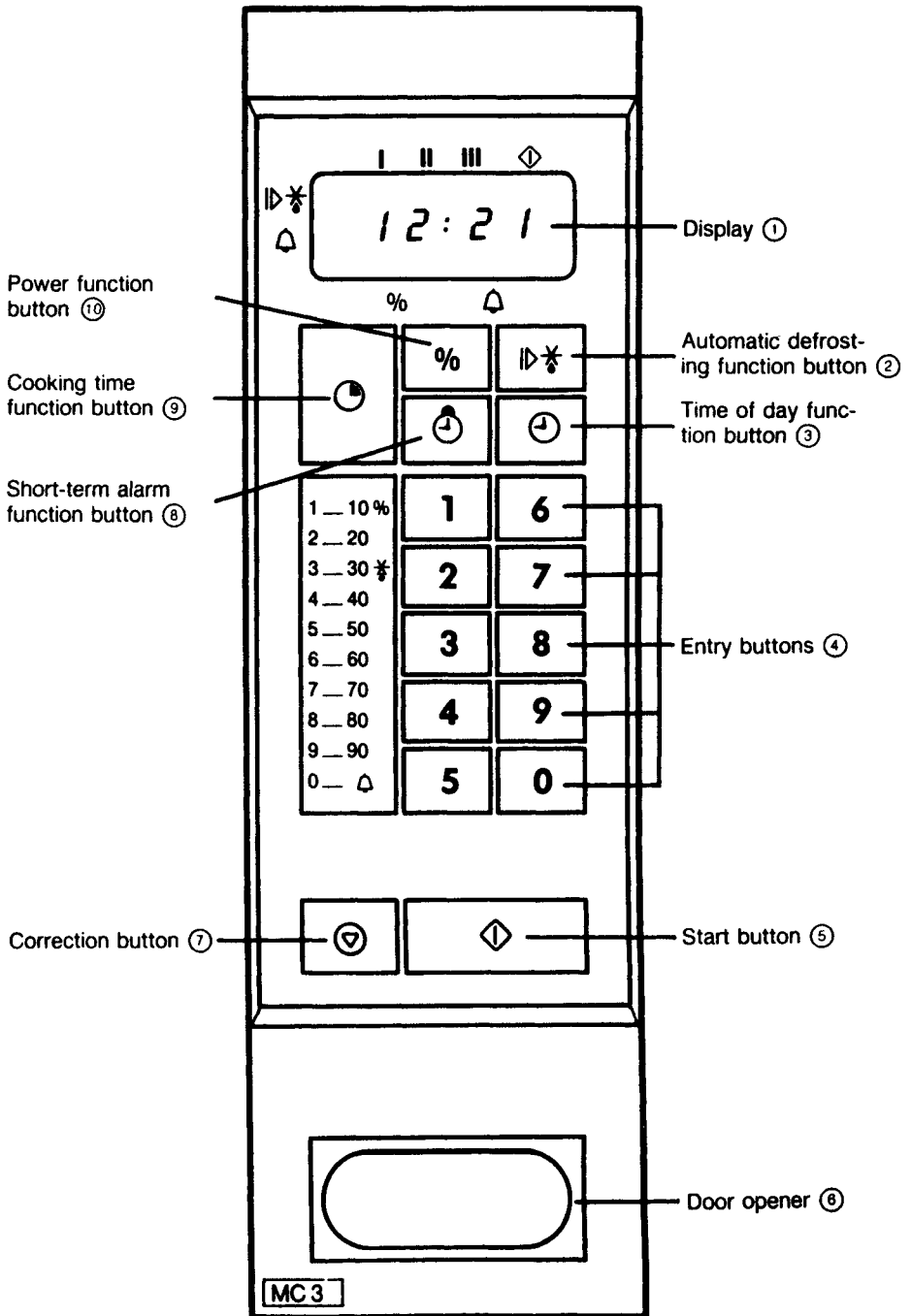

Cooking with time and power in 3 settings

You can consecutively set up to 3 combinations of time and power as described in page 28 under cooking with time and variable power!

You start the programs e. g. for

1. The defrosting setting (display ① I)
2. The boost function setting at the start of cooking (display ① II).
3. The simmering setting (display ① III)

by pressing the start button ⑤ ↵.

The sequence is then automatic.

An audible signal tone indicates transition from one setting to another.

An audible signal sounds at the end of the automatic sequence. The time of day reappears in the display ①.

Defrosting

Manual defrosting

Frozen food is defrosted with the defrosting program 3-30[✳] or at the times and powers indicated in the "Cooking tables" booklet.

Press the cooking time button ⑨ ⌚ and enter the defrosting time with the entry buttons 0-9.

Press the power button ⑩ % and entry buttons ④ 3-30[✳].

Press the start button ⑤ ↵.

The elapsing defrosting time appears in the display ①.

An audible signal sounds at the end of the defrosting sequence. The time of day reappears in the display ①.

Automatic defrosting

This defrosting program marked |▷[✳] consists of a higher-power boost function at the start of defrosting and a following defrosting sequence at low power (see following table).

Press the automatic defrosting button ② |▷[✳].

Enter the defrosting time with the entry buttons ④ 0-9.

Press the start button ⑤ ↵.

The elapsing defrosting time appears in the display ① and, beside the |▷[✳] symbol (automatic defrosting) a dash.

An audible signal sounds at the end of the defrosting sequence. The time of day reappears in the display ①.

Short-term alarm

You can use the short-term alarm **without any switching function simply as an alarm.**

Press the short-term alarm button ⑧ ⌚.

Enter the alarm time with the entry buttons ④ 0-9.

Press the start button ⑤ ↵. The time of day appears in the display ①, and the alarm time automatically elapses.

An audible signal sounds at the end of the alarm time. This can be switched off by pressing the correction button ⑦ ⌚.

Table for defrosting of poultry/meat with automatic defrosting system |▷✱

Type/quantity	Hints/remarks	Time minutes	Standing time at room temperature minutes
Chicken 1000 g	Turn from time to time. Possibly cover legs with aluminium foil	25-30	10-20
Duck (1.5-2 kg) 1500-2000 g	See above	34-40	40-60
Joint 500 g	Turn from time to time. Possibly cover fatty areas with pieces of aluminium foil	12-16	10-15
Schnitzel/steak 200 g	See above	4- 6	5-10
Mince meat 250 g	Separate from time to time. Remove defrosted pieces.	5- 7	5-10
Goulash 500 g	Separate from time to time. Place inside pieces on outside	10-12	10-15
Giblets (liver, kidneys) 500 g	Turn from time to time. Possibly cover edges with aluminium foil	8-10	10-15
Back of hare 600 g	Turn from time to time. Possibly cover edges with aluminium foil	12-14	15-20
Haunch of roe deer, wild boar 1000 g	See above	18-25	30-40

The correct ovenware

Operating mode	Glass	Glass ceramic	Porcelain	Earthenware	Plastic ware ²⁾	Paper cups	Paper plates	Greaseproof paper	Board	Aluminium foil ³⁾	Aluminium containers of convenience foods ³⁾	Metal objects ⁴⁾	Containers with metal decor	Keep-fresh foil	Roasting foil
Microwave mode															
● Defrosting	X ¹⁾	X	X ¹⁾	X ¹⁾	X	X	X	X	X	X	X	-	-	X	X
● Heating	X ¹⁾	X	X ¹⁾	X ¹⁾	X	-	-	X ⁵⁾	X ⁵⁾	X	X	-	-	-	X
● Cooking	X ¹⁾	X	X ¹⁾	X ¹⁾	X	-	-	-	-	X	X	-	-	-	X

1) But without silver, gold, platinum, or metal decor.

2) Please note the relevant manufacturer's instructions.

3) **Important:** Please follow the instructions given under "Practical hints on working with microwave appliances".

4) For exceptions, see "Golden rules" on pages 23/24.

5) **Under prolonged heating, there is a risk of fire!**

Special browning skillet (special accessory)

Since, during microwave cooking with short roasting times or with very lean meat, no heavy browning of the food is achieved, a special browning skillet has been developed. This browning skillet has a bottom coating which becomes very hot when the skillet is preheated empty.

The roast is browned by this heat. The preheating time for this skillet is variously long and depends on the required degree of browning of the food concerned.

The AEG browning skillet and grille plate are obtainable from your electrical retailer.

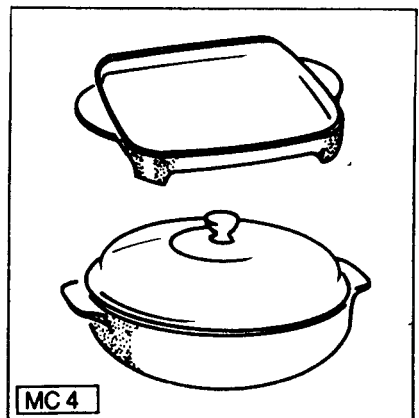

Cleaning and care

Cleaning your appliance

This should be carried out only when the appliance is unplugged from the mains supply.

Use only mild cleaners and hot water.

Clean your appliance inside and outside with a soft cloth. Never use abrasive scouring agents.

You can neutralize odours inside the cooking space by boiling a cup of water with a little lemon juice for a few minutes in your appliance.

Note: Never switch on your appliance if the door seal is damaged.

Have your appliance checked by a trained service engineer.

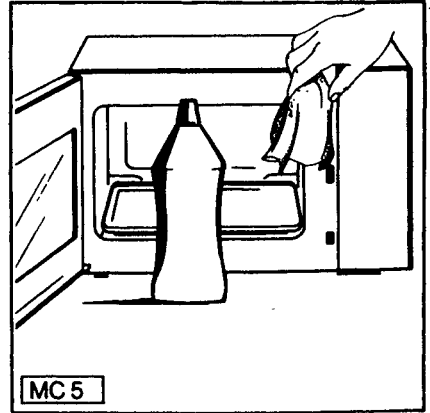

Changing the cooking space lighting

To change the cooking space lighting, proceed as follows:

- Unplug your appliance from the mains supply.
- Remove flap on LH side by loosening two Phillips screws.
- Change E14 220 V/max. 25 W lamp.
- Screw back flap.
- Replug your appliance into the mains supply.
- Check lamp by opening door.
- Re-enter time of day.

Changing the defective cooking space lighting does not fall under the guarantee and is therefore not free of charge.

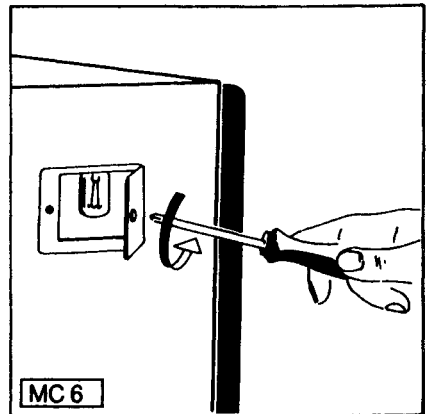

If you think your microwave oven is not functioning properly

Before calling the service centre, please check whether, on the basis of the following hints, you can rectify the fault yourself. If your microwave oven no longer works, check whether:

1. your appliance is plugged into the mains supply;
2. the fuses in the fixed wiring are in order;
3. the door is fully closed.

If, after these checks, your microwave oven still does not work, please call the service centre.

- If, however, you decide to call in the service centre to help with any of the stated instructions or on grounds of faulty operation, the service engineer's visit cannot be made free of charge even during the guarantee period.
- You should therefore take careful note of our instructions on operation of your microwave oven in these instructions as well as our additional recommendations and hints in the recipe booklet.

Questions and answers to enable you to familiarize yourself quickly with this new form of cooking

Question:

It appears that foods cooked in a microwave oven cool more rapidly than those cooked in the conventional way. How is that explained?

Answer:

The container used to store the food in the refrigerator is frequently also used to warm it in the microwave oven. In this case, the cold container absorbs heat from the food. It may therefore be necessary to warm the food for 1 minute longer.

Question:

Why does moisture remain in the microwave oven after cooking?

Answer:

The moisture on the inside of the cooking space is normal and should give no cause for concern. It is produced by steam which condenses on the cool surfaces whilst food is cooking.

Question:

Will operation of my new microwave oven be expensive?

Answer:

No. Cooking by microwave oven is very economical. It consumes up to 70 % less energy than a conventional oven.

Installing the tabletop appliance

Installing the tabletop appliance

To ensure trouble-free ventilation, an air space of 5 cm around the appliance is necessary.

Connect to a plug socket with protective earth contact and fused with a 10 A L-automatic device or 10 A slow-blowing fuse!

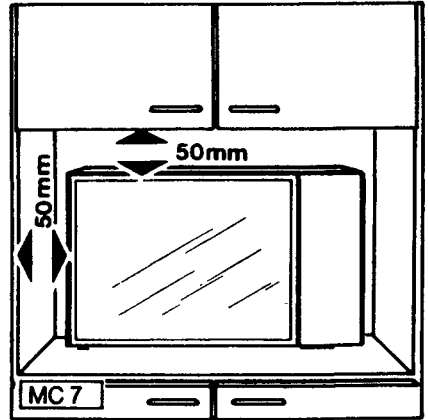

Rating plate

AEG electrical appliances comply with the valid safety requirements. Repairs to electrical appliances should only be performed by a trained electrician. Improper repairs may place the user at serious risk.

In the event of any enquiries and faults, please contact our service centre (see list of service centres).

In the interests of technical development, we reserve the right to make alterations to the design of our products at any time.

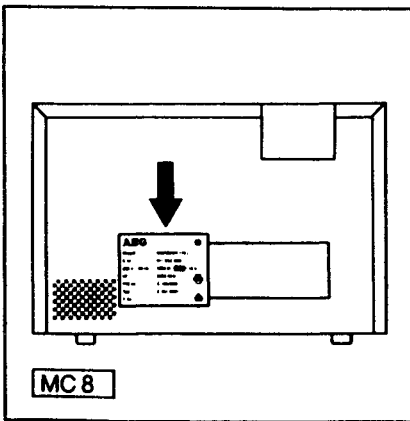

Please enter the following numbers of your oven below. You will find the numbers on the rating plate on the rear of your microwave oven/arrow.

Model No.:

E-No.:

DBP-No.:

F-No.:

Technical data

Voltage:	220 V, 50 Hz
Connected load:	1150 W
Power output:	
– full power:	600 W (measured to DIN 44566-04/89)
– defrosting:	around 180 W
Controllable from:	10 % to 100 % of full power
Fuse:	10 A-L
Cooking time preselection: 1 sec to 99 min 99 sec.	

Tabletop appliance:

Dimensions (HxWxD) mm:

Housing: 337 x 494 x 387

Cooking space: 183 x 300 x 300

Weight: around 22 kg

This appliance complies with the radio interference suppression requirements of EC Directive 82/499 EC as well as with the Standard relating to the Retroactive Effect of the Mains Supply EN 60 555 Parts 1–3/DIN VDE 0838 Parts 1–3, June 1987

Data for test centres

DIN No. 44 566 Part 2	Power (%)	Duration in min.	Adjustment time in min.	Remarks
4.5.1.1.1	30	35	20	placed on inverted saucer and turned after half time
4.5.1.1.2	30	16	14	turned after half time, spread out on the plate
4.5.1.1.3	30	10	13	covered
4.5.1.2.1	100	20		covered
4.5.1.2.2	100	20		covered
4.5.1.3.1	100	11		covered, turned after half time, and the pieces placed from the centre with the corners outwards
4.5.1.3.2	100	10		covered
4.5.1.4.1	100	20		covered
4.5.1.5.1	100	25		covered
4.5.1.5.2	100	27		turned after half time, covered

AEG Domestic Appliances Ltd

Customer Care Department

55-77 High Street

Slough

Berkshire SL1 1DZ

Telephone: 08705 350350