

LAVAMAT TURBO 16830

Washer-dryer

Instruction Booklet

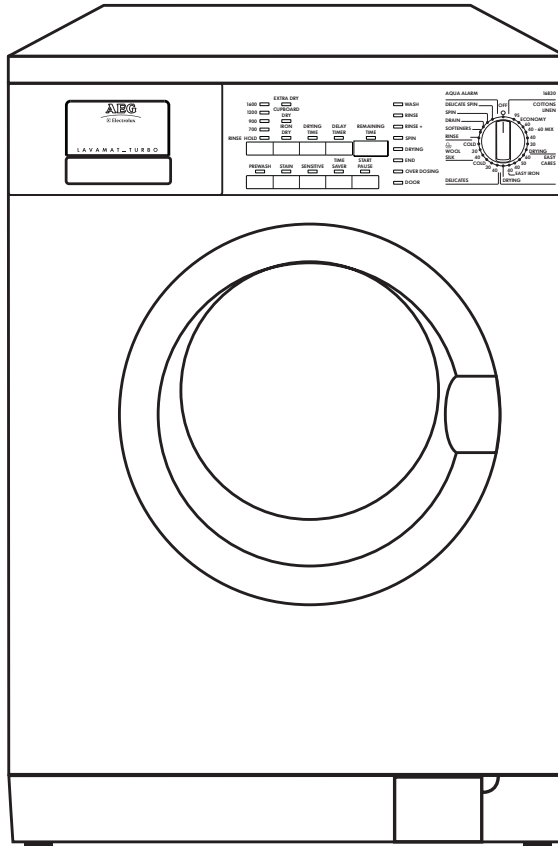

AEG

PERFEKT IN FORM UND FUNKTION

Electrolux

Dear customer,

Please read these operating instructions carefully and pay particular attention to the safety notes indicated in the first pages. We recommend that you keep this instruction booklet for future reference and pass it on to any future owners.



The warning triangle and/or the key words (Warning!, Caution!) emphasize information that is particularly important for your safety or correct functioning of the appliance.



This symbol guides you, step by step, in the operation of the appliance.



The information marked with this symbol provides additional instructions and practical tips on the use of the appliance.



Tips and information about economical and ecological use of the machine are marked with the clover symbol.

Should any problems arise, this booklet provides instructions on how to solve them by yourself; see section "Something not working?".

If this information is not sufficient, please contact our nearest SERVICE CENTRE (address and telephone numbers are indicated on the enclosed leaflet).

Printed on recycled paper.
People who think ecologically, act accordingly...

Contents

Safety instructions	6
Disposal	8
Tips for environmental protection	8
Main features of your washer-dryer	9
Description of the appliance	10
Control panel.....	11
Programme selector dial.....	11
Programme Option buttons.....	12
PREWASH.....	12
STAIN.....	12
SENSITIVE.....	12
TIME SAVER.....	12
START/PAUSE button.....	13
SPIN SPEED.....	13
RINSE HOLD.....	13
ELECTRONIC DRYING button.....	14
DRYING TIME button.....	14
DELAY TIMER button.....	14
Display.....	14-15
Programme progress display.....	15
Cancelling a programme.....	15
Altering a programme which is running.....	15
Opening the door after the programme has started.....	16
Detergent dispenser drawer.....	17
Before the first wash	17
Preparing the wash cycle	18
Sorting out and preparing the laundry.....	18
Weight of laundry.....	19
Types of fabric and care labels.....	19-20
Detergents and additives.....	21-22
Which detergent?.....	21
And in which form?.....	22
Fabric conditioners.....	22

Preparing the drying cycle	23
Load	23
Garments not suitable for drying	23
Drying symbols on garment labels	24
Duration of the drying cycle	24
Modification of the drying time or degree of drying.....	24
Fibre residue.....	24
Additional drying	24
How to wash	25
Load the laundry.....	25
Add detergent and additive.....	25
Selection of the desired wash programme.....	26
Selection of the desired options	26
Selection of the SPIN SPEED or RINSE HOLD option	26
Selection of the EXTRA RINSE	27
Selection of the DELAY TIMER option.....	27
Starting the programme.....	28
At the end of the programme.....	29
Automatic washing and drying (NON-STOP programme)	30
How to dry	30
Drying only.....	30
Programme charts: wash and special programmes	31-32
Programme chart: timed drying	33
Consumption data for timed drying	34
Cleaning and maintenance	35
After each wash	35
Periodical cleaning	35
Exterior	35
Detergent dispenser drawer	35
Drain pump.....	36
Water inlet filter	37
Emergency emptying out.....	37
Frost precautions.....	38
Something not working?	38
Troubleshooting.....	38-41
Unsatisfactory washing results	42

Technical data	43
Service and Spare Parts	44-45
Standard Guarantee Conditions	46
European Guarantee	47
Instructions for installation and electrical connection	48
Safety instructions for the installer	48
Dimensions of the appliance	49
Front view and side view	49
Rear view	49
Installation	50
Unpacking	50
Positioning	51
Levelling	51
Installation on a suspended floor	51
Water inlet	52
Water drainage	52
Electrical connection	54
Permanent connection	55



Safety instructions

Your safety is of paramount importance, please ensure you read this instruction book before installing or using this appliance.

General safety

- Repairs to the machine must be carried out only by qualified personnel. Repairs carried out by inexperienced persons could cause injury or serious malfunctioning. Contact your local AEG/ELECTROLUX Service Force Centre.
- Never start the machine if the mains cable is damaged or the control panel or worktop are damaged allowing inner components to be accessible.
- Unplug the appliance before carrying out any cleaning or maintenance operations.
- Never pull the mains cable to remove the plug from the socket; always take hold of the plug itself.
- During high temperature wash programmes and during the drying cycle, the door glass may get hot.
- Let the water cool down before carrying out emergency emptying or before opening the door in an emergency.

Installation

- Follow the installation instructions **carefully**.
- Carry out a first wash without laundry (COTTONS 60, with half the amount of detergent) in order to remove any manufacturing residue from the tub and the drum.
- **Your appliance is provided of a new «antiflood device».** To make active this feature is needed close the bottom of the machine with the bottom cover that you can find inside the drum. Please read the instructions inserted into bottom cover bag.

Child safety

- This appliance is designed to be operated by adults. Children should not be allowed to tamper with the controls or play with the appliance.
- Pets and children have been known to climb into washing machines. Please check the drum before use.
- Keep all packaging well away from children.
- Keep all detergents in a safe place out of children's reach.
- When disposing of the appliance, cut off the mains cable, and destroy the plug. Disable the door catch to prevent young children being trapped inside.

During use

- Always unplug the appliance and turn off the water tap after use.
- This appliance is designed for domestic use only. If the machine is used for any other purposes or is not used correctly, the manufacturer accepts no responsibility for any possible damage that might occur.
- For safety reasons, the appliance must not be modified.
- Use only detergents suitable for washing machines and follow the manufacturer's instructions.
- Garments which have been in contact with flammable solvents should not be machine washed.
- Dyes and bleaching agents may only be used if specifically permitted by the manufacturer of these products. We cannot be held liable for any damage.



Disposal

Packaging materials

The materials marked with the symbol  are recyclable.

>PE<=polyethylene

>PS<=polystyrene

>PP<=polypropylene

This means that they can be recycled by disposing of them properly in appropriate collection containers.

Machine

Use authorised disposal sites for your old appliance. Help to keep your country tidy!

The symbol  on the product or on its packaging indicates that this product may not be treated as household waste. Instead it shall be handed over to the applicable collection point for the recycling of electrical and electronic equipment. By ensuring this product is disposed of correctly, you will help prevent potential negative consequences for the environment and human health, which could otherwise be caused by inappropriate waste handling of this product. For more detailed information about recycling of this product, please contact your local city office, your household waste disposal service or the shop where you purchased the product.



Tips for environmental protection

To save water, energy and to help protect the environment, we recommend that you follow these tips:

- Normally soiled laundry may be washed without prewashing in order to save detergent, water and time (the environment is protected too!).
- Use the energy saving programme (Economy) when washing normally soiled garments.
- The machine works more economically if it is fully loaded (for both washing and drying cycles).
- When small loads are washed, use only half to two thirds of the recommended amount of detergent.

-
- The machine will consume less energy if the laundry is **adequately spun** before being dried.
 - With adequate pre-treatment, stains and limited soiling can be removed; the laundry can then be washed at a lower temperature.

Main features of your washer-dryer

- Programme and temperature setting using the programme selector.
- **Stain programme** for effectively treating stained washing.
- **Energy saving programme (Economy)** for normally soiled cotton items.
- **Speed for the final spin** can be reduced to 1200, 900 or 700 rpm.
- **RINSE HOLD**: the laundry is left immersed in the final rinse water to prevent creasing.
- **DELAY TIMER (delayed start)**: programme start can be delayed by 30 minutes to 23 hours (e.g. to times with a more economical power rate).
- **Programme progress display** showing the programme steps selected and the programme phase which is running.
- Because of its gentle washing action, the **special wool cycle** washes your garments with extreme care.
- **The drying programmes** will enable you to have dry and soft laundry in a short time.
- **3-compartment drawer** for detergent and fabric softener.
- **Unbalance detection device**: to prevent vibration during spinning.

Description of the appliance

Front view

Detergent drawer

Control panel

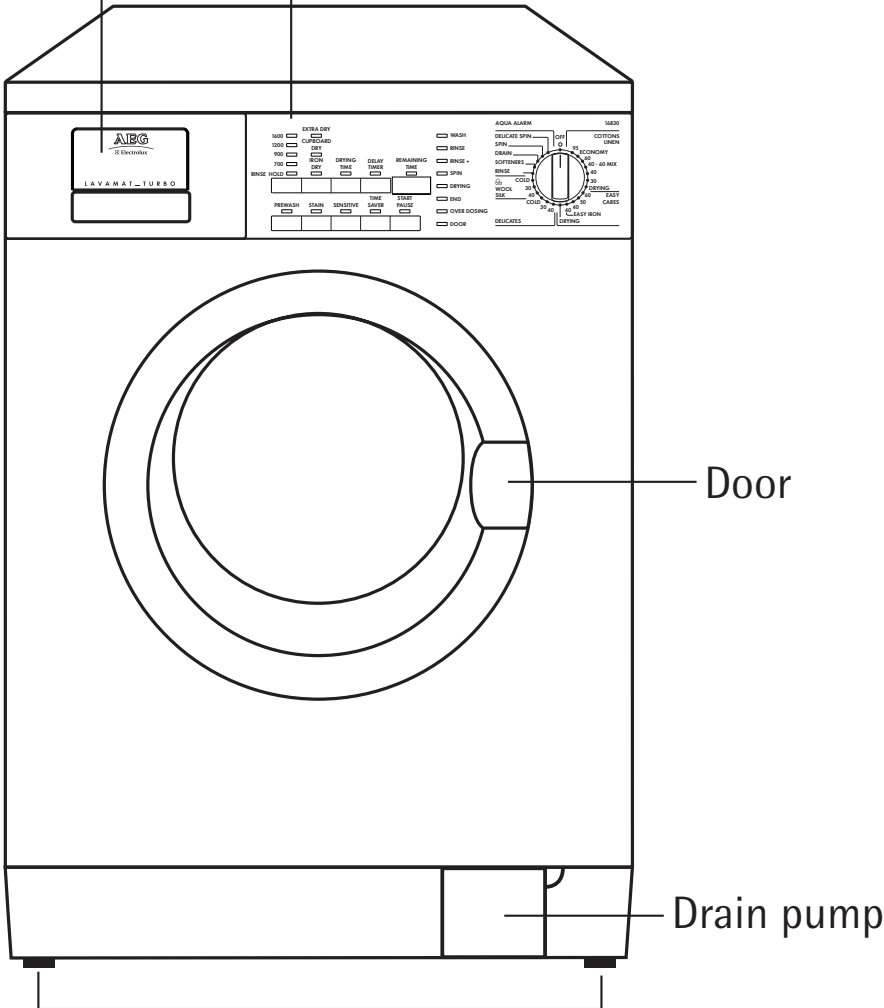

Door

Drain pump

Adjustable feet

Control panel

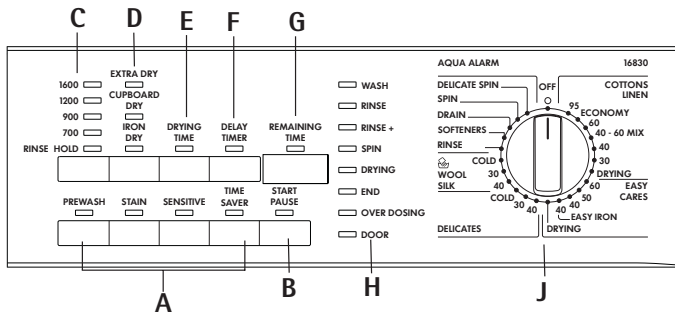



- A = Option buttons
- B = START/PAUSE button
- C = Spin speed button
- D = Electronic drying button
- E = Drying time button
- F = Delay start button
- G = Display
- H = Programme progress display
- J = Programme selector dial

Programme selector dial

The programme selector determines the type of washing cycle (e.g. water level, drum movement, number of rinses), the washing temperature and enables the required drying programme to be selected according to the type of laundry.

The selector dial is divided into 6 sections:

- Cottons-Linen
- Easy Cares (synthetics)
- Delicates
- Wool/silk  (hand washing)
- Special programmes
- Reset programme 

The selector dial can be turned either clockwise or anticlockwise.

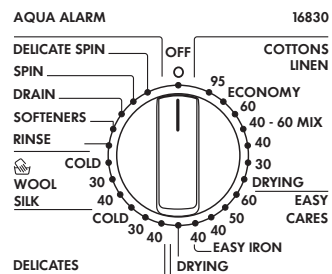

Position **ECONOMY** corresponds to the ENERGY SAVING programme for normally soiled laundry, extended washing time (cannot be combined with TIME SAVER). The washing temperature will decrease.

Position 40°C Easy iron.

In this position the laundry is gently washed and spun to avoid any creasing. In this way ironing is easier.

Position COLD = cold wash

Programme Option buttons

Depending on the programme, different functions can be combined. These must be selected after choosing the desired programme and before depressing the START/PAUSE button.

When these buttons are pressed, the corresponding pilot lights come on. When they are pressed again, the pilot lights go out.

When an incorrect option is selected, the button light flashes for 2 seconds and in the display the Err message appears.

PREWASH

The machine performs a prewash cycle. The prewash cycle ends with a short spin in programmes for Cotton and Easy cares, and with emptying of the water without spinning for Delicates.

This option is **not** available with the wool programme and **cannot** be used with STAIN option.

For use when washing heavily soiled laundry.

STAIN

To treat heavily soiled or stained laundry with stain remover (extended main wash with time optimised stain action phase, not selectable for wool or programmes with temperatures lower than 40°C).

This function cannot be used with PREWASH.

SENSITIVE

By depressing this button the washing intensity will be reduced. The machine adds one rinse in the programmes for COTTONS and EASY CARES. This option **cannot** be used with EASY IRON.

TIME SAVER

By pressing this button the washing time is reduced. For use when washing lightly soiled laundry.

This option is **not** available with wool and **economy** programme.

START/PAUSE button

This button has two functions:

a) Start

After having selected the required programme, press this button to start the machine. If you have selected the DELAY TIMER option, the machine starts its hourly countdown.

b) Pause

To interrupt a programme which is running, press the START/PAUSE button: the information on the display remains lit and the START/PAUSE pilot light starts to flash.

To restart the programme from the point at which it was interrupted, press the START/PAUSE button again.

SPIN SPEED

Press this button to reduce the maximum speed of the final speed proposed by the machine for the selected programme or to select RINSE HOLD option. The maximum spin speed for cotton is 1600 rpm, for easy cares, wool and delicates 900 rpm.

Important: By depressing the SPIN SPEED and DRYING TIME buttons at the same time the machine will perform an extra rinse (see page 27).

RINSE HOLD

By selecting this option, the last rinse water is not emptied out, to prevent the fabrics from creasing. When the programme has finished, the pilot light END on the programme progress display illuminates, the the pilot light DOOR is red to indicate that the water must be emptied out.

To empty out water:

- select the DRAIN programme to empty out the water without spinning.
- select the SPIN/DELICATE SPIN programmes for spinning.
- select the SPIN SPEED and depress the START/PAUSE button;

Warning! The programme selector dial must be turned first to O/OFF and then to the DRAIN, SPIN or DELICATE SPIN programmes.

The RINSE HOLD option **cannot** be selected for the automatic WASHING & DRYING programme.

ELECTRONIC DRYING button

This button enables you to choose the required degree of drying for cottons and synthetics:

- Extra dry (not for easy cares)
- Cupboard dry
- Iron dry (not for easy cares)



The drying time is automatically adjusted by the machine: the laundry will be dried to the selected degree of dryness.

DRYING TIME button

If you wish to carry out a timed programme instead of an electronic programme push the button until the drying time you want appears in the display according to the fabrics (cotton or easy cares) you have to dry.

For **COTTON** and **EASY CARES** you can select a drying time from 10 minutes to 130 minutes.

DELAY TIMER button

The wash programme can be delayed from 30, 60, 90 minutes and then 1 hour by 1 hour up to a maximum of 23 hours.

The button must be pressed after selecting the programme and before pressing the START/PAUSE button.

The figures indicating the delay appear for about 3 seconds in the display. The duration of the selected wash programme is then displayed. After depressing the START/PAUSE button, the machine starts its hourly countdown.

To annul the preset delay, press the START/PAUSE button, then press the DELAY TIMER button until the symbol \emptyset is displayed.

Then press the START/PAUSE button again.

Display

The display shows the following information:

- **Duration of the selected programme (in minutes)**, calculated automatically on the basis of the maximum recommended load for each type of fabric.
- **Selected drying time** (max. 130 minutes for cotton and easy cares).
After the programme has started, the time remaining is updated every minute.

- When the programme has finished, a **steadily lit zero** is displayed.
- **Delayed start**, (23 hours max.) programmed using the special button. The countdown is updated every hour.
- **Alarm code** indicating a fault in the machine operation (see page 38).

Programme progress display

By selecting the wash programme, the pilot lights corresponding to the various phases making up the programme come on.

After the machine has started, only the running phase pilot light stays on. When the programme has finished, the END pilot light comes on.



When the programme has finished, if the OVER DOSING light comes on, it indicates that too much detergent has been used or that the drain filter is blocked.

Cancelling a programme

To cancel a programme which is running, turn the programme selector dial to the **O/OFF** position.

Warning! After a programme which ends with water in the drum (RINSE HOLD option), turn the selector dial first to **O** and then to the DRAIN, SPIN or DELICATE SPIN programme.

Altering a programme which is running

To alter a programme, first set the machine to PAUSE by pressing the START/PAUSE button.

Any function can be modified before the machine starts it. After selecting the new option press the START/PAUSE button again to re-start the selected programme.

To modify the selected programme turn the programme selector dial to **O/OFF** and then choose a new programme.

The water is **not** emptied out and after pressing the START/PAUSE button again the machine restarts with the newly selected programme.

Opening the door after the programme has started

To open the door set the machine to PAUSE by pressing the START/PAUSE button.

The DOOR light on the control panel beside the START/PAUSE button indicates if the door can be opened:

- green light: the door can be opened;
- red light: the door cannot be opened;



The door can be opened if:

- the machine is not already heating or drying;
- the water level is not above the bottom edge of the door;
- the drum is not turning.

If you need to open the door, switch the machine off by turning the selector dial to position **O/OFF**, and wait about 3 minutes before opening the door (pay attention to the temperature and the level of the water in the tub).

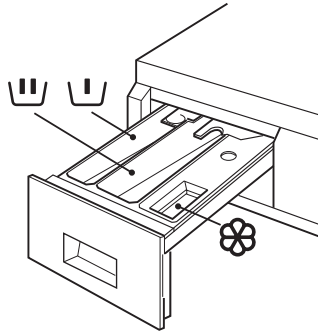
Detergent dispenser drawer



-  Compartment for prewash or stain remover. The prewash detergent is added at the beginning of the wash programme. The stain remover is added during the STAIN-Action phase in the main wash.
-  Compartment for powder or liquid detergent used for main wash. It is emptied at the beginning of the wash cycle.
-  Compartment for liquid additives (fabric softener, starch). It is emptied at the last rinse.

The quantity of additives must not exceed the "MAX" mark in the drawer.

Before the first wash

Before your first wash, we recommend that you run a cotton cycle at 95°C, **without any laundry in the machine**, to remove any manufacturing residue from the drum and tub.

Pour 1/2 a measure of detergent into the dispenser drawer and start the machine.

Preparing the wash cycle

Sorting out and preparing the laundry

- Sort out the laundry according to type of fabrics and care labels (see "Types of fabric and care labels").
- Empty pockets.
- Remove any metal parts (safety pins, clips, etc.).
- To prevent the laundry from getting damaged and forming bundles, it is advisable to close zips, button up pillowcases and quilt covers and tie up loose straps such as those of aprons.
- Turn double faced items inside out (sleeping bags, anoraks, etc.)
- Turn coloured knitted fabrics, woollens and fabrics with trim inside out.
- Wash small and delicate items (baby socks, tights) inside a laundry net or in a pillow case closed with a zip, or in larger socks.
- Treat curtains with special care. Remove all metal or plastic hooks or put them in a net or a bag. We decline any responsibility in case of damage.
- Whites and coloureds must be washed separately: white items can lose their whiteness.
- New coloured fabrics often have excess dyes; it is advisable to wash them separately for the first time.
- Wash small and large items together; this improves the washing result and the laundry is better distributed during spinning.
- Shake out garments before putting them into the machine.
- Insert each garment separately.

Weight of laundry

Sort of laundry	Approximate dry weights
Bathrobes	1200 g
Work shirts	300-600 g
Quilt covers	700 g
Sheets	500 g
Blouses	100 g
Hand towels	200 g
Tea towels	100 g
Shirts	200 g
Pillowcases	200 g
Night-gowns/Pyjamas	200-250 g
Tablecloths	200-300 g
Underwear	250 g

Types of fabric and care labels

The labels on garments help you to select the most suitable wash programme. The laundry should be sorted out according to the type of fabric and the instructions indicated on care labels.

Temperatures indicated on labels are always maximum temperatures.

Cotton 

Linen and cottons marked with this symbol can be washed at high temperatures.

Cotton 

Linen and cottons marked with this symbol are colourfast and can be washed at 60°C.

Cotton  

Garments marked with these symbols have delicate colours, therefore the washing temperature must not exceed these values.

Synthetics  

Mixed and synthetic fabrics marked with these symbols require a gentle wash programme and they must therefore be washed using the specific programme.

Delicates  

Microfibres, synthetics or curtains marked with these symbols require a very gentle treatment.

The DELICATES programme is suitable for this type of fabric.

Woollens and particularly delicate items    

Fabrics such as wool, wool mix or silk marked with this symbol are particularly sensitive to machine washing.

The WOOL programme  is suitable for this type of fabric.

The wool wash cycle of this machine has been approved by Woolmark for the washing of machine washable Woolmark products provided that the garments are washed according to the instructions on the garment label and those issued by the manufacturer of this machine. M9605.

If the label has the symbol  (do not wash), the garments must not be machine washed!

Detergents and additives

Which detergent?...

To ensure you obtain the best wash results from your appliance, it is important to use the right detergent in your everyday wash, and only detergents recommended for use in automatic machines.

To maintain the appearance of your clothes and household textiles and to make them last longer you should use different types of detergent for different washes, whether for whites, colours or delicates.

WHITES

We recommend the Ariel product range which is biological and designed to provide excellent cleaning and stain removal even at low temperatures.



NON BIOLOGICAL

If you prefer to use a non biological detergent, which does not contain enzymes we recommend Fairy. Fairy provides good cleaning and stain removal.



COLOURED

For coloured items you should use a detergent which is designed to clean while maintaining the original colour. Ariel Color does not contain bleach and therefore helps to preserve colours.



DELICATE ITEMS

When washing delicates such as woollens, you should use a product which is specially designed to care for fine fabrics. Dreft Automatic is suitable for woollens and other delicates.



LAUNDRY BLEACH

For additional stain removal you may wish to use a product such as Ace Gentle Bleach which is used in addition to your chosen detergent. Ace is suitable for all washable fabrics including silks, woollens and coloureds.



STAIN REMOVER

For heavily soiled garments to be washed with STAIN-Action, you should use stain removers such as VANISH In-Wash, Ecover Stain Salt and GloWhite Booster.



And in which form?

Not only are there different types of detergent, but they are also available in different forms. Whether you chose a powder or liquid in traditional or compact form is your own personal choice.

TRADITIONAL POWDERS

Pour the powder directly into the dispenser drawer. Do not sprinkle powder onto clothes in the machine drum.

TRADITIONAL LIQUIDS

Liquid can be placed in the main wash compartment of the detergent drawer marked with the symbol , start the machine immediately upon placing the detergent in the dispenser drawer.

Alternatively the detergent is measured into the specially designed dosing device* which should be placed on top of the laundry, and at the back of the machine drum.

COMPACT POWDERS AND LIQUIDS

Compact detergents (or concentrates as they are also known) are available in liquid or powder form, and generally require a smaller dosage. Follow the manufacturer's instructions to ensure the most economical usage. Pour the detergent directly into the dispenser drawer, or alternatively measure the detergent into the specially designed dosing device* which should be placed on top of the laundry, and at the back of the machine drum.

*** If you use a dosing device in a washer dryer, please ensure the dosing device/ball is removed before carrying out a drying programme.**

FABRIC CONDITIONERS

These are ideal for improving "softness", and also reduce static cling on easy-cares and make ironing easier. They are available in two types:

- For example Lenor liquid fabric softener, for use in the **washing machine/washer dryer**. The liquid fabric softener should be poured into the compartment marked with the symbol . Follow the manufacturer's dosage instructions and never exceed the MAX level.



- Bounce conditioning sheets for use in a **tumble dryer**. We recommend the conditioning sheets are pinned (using a safety pin) to an article of laundry and placed in the tumble dryer.



Preparing the drying cycle

As a dryer, the machine works on the condensation principle.

Therefore, **the water tap must be open and the drain hose must drain water into a sink or into the drain pipe, even during the drying cycle.**

Load

Sort of laundry	max. load (dry weight)
Linen and cottons	3.5 kg
Easy cares	2 kg

Warning:

Loads of washed laundry exceeding these values must be divided before being dried, otherwise poor results will be obtained.





Garments not suitable for drying

- Particularly delicate items such as synthetic curtains, woollen and silk, garments with metal inserts, nylon stockings, bulky garments such as anoraks, bedcovers, quilts, sleeping bags and duvets must not be machine dried.
- Garments padded with foam-rubber or materials similar to foam-rubber must not be machine dried; they represent a fire hazard.
- Also, fabrics containing residues of setting lotions or hair sprays, nail solvents or similar solutions must not be machine dried in order to avoid the formation of harmful vapours.

Drying symbols on garment labels

Always look at the garment label to check whether garments can be machine dried.

The following symbols refer to drying:

-  Machine drying is usually possible
-  Normal drying (normal temperature)
-  Gentle drying (reduced temperature)
-  Do not machine dry

Duration of the drying cycle

The drying time can vary according to

- the final spin speed;
- the required degree of drying (extra dry, cupboard dry or iron dry);
- the type of laundry;
- the size of load.

The usual drying times for the timed programmes are indicated in the programme chart (pag. 33). As you become more familiar with the appliance, you will discover the drying times that best suit your needs according to the various type of fabric. It is a good idea to make a note of these times.

Modification of the drying time or degree of drying

(just in case of washing + drying)

If you wish to modify the drying time or the degree of drying when a drying programme is running, first depress START/PAUSE button to set the machine to PAUSE. After modifying the time or degree, depress START/PAUSE again to continue the programme.

Fibre residue

After drying fluffy fabrics, such as new towels, it is advisable to perform the RINSE programme to be sure that any residue that may remain in the tub is completely removed and does not stick to garments dried afterwards.

After each drying cycle the filter should be checked and cleaned.

Additional drying

Should the laundry still be too wet at the end of the programme, set another short drying time.



Warning! To prevent the formation of creases or shrinking of fabrics, avoid excessive drying.

i How to wash

Max. load



- cottons 7 kg
- easy cares and delicates 3 kg
- wool, silk and  (handwash) 2 kg

Load the laundry

-  Open the door.
-  Place the laundry in the drum, one item at a time. Distribute laundry as evenly as possible. Close the door.

Add detergent and additive

-  Pull the drawer out until it stops.



-  Pour the main wash detergent into compartment .

If you wish to perform a pre-wash, a STAIN-

Action programme, pour detergent or stain remover into compartment .

Important!

Do not use normal detergent for the STAIN-Action programme, always use a STAIN remover.

-  Pour the fabric softener into compartment  without exceeding the "MAX" mark.
-  Close the drawer gently, pushing it fully in.

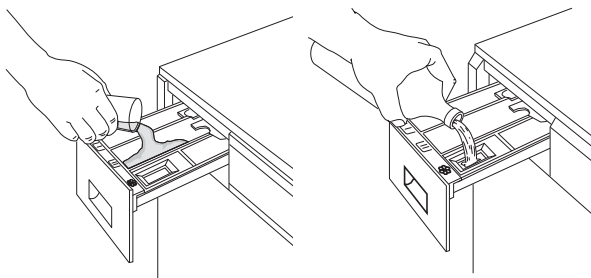

Selection of the desired wash programme

 Turn the programme selector dial to the desired position: the lights corresponding to the different phases making up the selected programme light up. The display shows the duration of the programme.

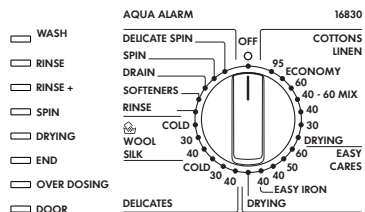

Selection of the desired options

The options available depend on the degree of soiling of the laundry. The corresponding light comes on.

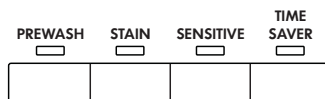

Selection of the spin speed or RINSE HOLD option

 It is possible to select a lower spin speed by means of the relevant button; the light corresponding to the selected speed comes on.

When selecting the RINSE HOLD option, the laundry is left immersed in the final rinse water.



If the spin speed is not reduced, the final spin speed will be as follows:

- cottons, linens 1600 r.p.m.
- easy cares 900 r.p.m.
- delicates 900 r.p.m.
- wool/silk  (hand washing) 900 r.p.m.

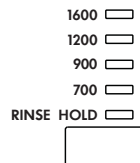

EXTRA RINSE

This appliance is designed for saving water. However, for people with a very delicate skin (allergic to detergents) it may be necessary to rinse the laundry using an extra quantity of water (extra rinse).



The extra rinse is available only with the cotton, easy care and delicates.

Selection of the RINSE + (extra rinse) option



Press simultaneously SPIN SPEED and DRYING TIME buttons for about 3 seconds: the RINSE+ light in the programme progress display comes on.

This function stays permanently on. To remove it press SPIN SPEED and DRYING TIME buttons again until the RINSE+ light comes off.

Selection of the DELAY TIMER option



To delay starting of a programme, press the DELAY TIMER button **before starting the machine**. The figures corresponding to the selected delay will be displayed for about 3 seconds, after which the duration of the selected programme will appear on the display.

When the START/PAUSE button is pressed, the selected delay will appear again on the display and the machine starts its countdown.

Starting the programme

1. Check that the water tap is open.
2. Press START/PAUSE to start the programme.



If the Delay Start option has been selected the programme will start at the end of the countdown.



At the start of the programme, if the "END" light blinks for few minutes, the acoustic signal sounds and on the display appears E40, that indicates that the door is open. Close the door and press the START/PAUSE button again.

If the delay start option has been selected, the machine starts its countdown, in hours, which will appear on the display. During this period it is possible to load other laundry, to cancel the delay time.

- **Load other laundry:** press the START/PAUSE button. Open the door. Load the laundry. Close the door and press the START/PAUSE button again.
- **Cancel the delay time:** press the START/PAUSE button. Press the DELAY TIMER button until on the display appears 0', if you wish to cancel it. Press the START/ PAUSE button again to let the programme restart.

Programme progress display

By selecting the wash programme, the pilot lights corresponding to the various phases making up the programme come on. After the machine has started, only the running phase pilot light stays on.

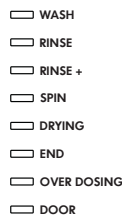

Display

The time to the end of the programme decreases minute by minute and appears on the display.



At the end of the programme

The machine stops automatically. A zero appears on the display. The END light comes on in the programme progress display, the START/PAUSE light is off and the DOOR light is green.



If the OVER DOSING light comes on it indicates that too much detergent has been used. At the next wash carefully follow the detergent manufacturer's instructions. Measure out detergent according to amount, type, degree of soil of fabrics and water hardness.

This light could come on also when the drain filter is blocked.



Turn the selector dial to **O**.



If the RINSE HOLD option has been selected the RINSE HOLD light remains lit and the DOOR light is red to indicate that the water must be emptied out before opening the door either

To empty out water:

- select the DRAIN programme to empty out the water without spinning.
- select the SPIN/DELICATE SPIN programmes for spinning.
- select the SPIN SPEED and depress the START/PAUSE button;

Warning! The programme selector dial must be turned first to **O/OFF** and then to the DRAIN, SPIN or DELICATE SPIN programmes.

At the end of the programme the selector dial must be turned to position **O/OFF**.



Remove the laundry from the drum.



Check that the drum is empty so as to avoid any forgotten items being damaged in a subsequent wash (e.g. shrinking) or their colour running into a load of whites.











Close the water tap.



Leave the door open to prevent the formation of mildew and unpleasant smells.

Automatic washing and drying (NON-STOP programme)

Warning! For NON-STOP programmes, it is also essential not to exceed the maximum load sizes of 3.5 kg for cotton and 2 kg for easy cares.

-  Load the laundry.
-  Add detergent and additive.
- Do not use a dosing device when carrying out automatic washing and drying programme.**
-  Select the wash programme.
-  Select the required options by means of the relevant buttons. If possible, **do not select** a spin speed lower than that proposed by the appliance to avoid a too long drying time so saving energy.
When automatically washing and drying it is not possible to select a spin speed lower than 900 r.p.m. for cottons.
-  Select the drying time or degree of drying.
-  Start the programme by depressing the START/PAUSE button.
-  At the end of the programme, turn the selector dial to O/OFF.
-  Remove the laundry.





How to dry

Drying only

Max. load

- cottons 3.5 kg
- synthetics 2 kg

During the drying programme the water tap must be open and the drain hose must be correctly positioned.

-  Turn the programme selector dial to DRYING for cottons or easy cares.
-  If you wish to carry out the timed drying press the relevant button until the time you want appears in the display.
-  If you wish to carry out the electronic drying depress the relevant button until the light corresponding to the degree of dryness required (extra dry, cupboard dry or iron dry) illuminates.
-  Press the START/PAUSE button to start the programme.
-  At the end of the cycle turn the programme selector dial to O/OFF and remove the laundry.

Programme chart

Wash programmes

Wash programme	Temp.	Fabrics	Additional functions	Max. load	Consumption*		
					Energy kWh	Water lt.	Duration min.
White Cottons	95°-60°	Cotton and linen, for example normally soiled work garments, sheets, household linen, underwear, towels.	STAIN PREWASH TIME SAVER SENSITIVE EXTRA RINSE RINSE HOLD SPIN SPEED	6 kg	2.30	61	143
ECONOMY	60°	Cotton and linen, for example normally to lightly soiled sheets and household linen.	STAIN PREWASH SENSITIVE EXTRA RINSE RINSE HOLD SPIN SPEED	7 kg	1.19	56	99
Coloured cottons	60°-40°-30° 40°-60° MIX	Coloured cotton or linen fabric, shirts, underwear, towels.	STAIN PREWASH TIME SAVER SENSITIVE EXTRA RINSE RINSE HOLD SPIN SPEED	6 kg	1.30	57	122
Easy cares	60°-50° 40° EASY IRON	Synthetic fabrics, underwear, coloured garments, non-shrink shirts, blouses.	STAIN PREWASH TIME SAVER SENSITIVE EXTRA RINSE RINSE HOLD SPIN SPEED	3 kg	0.95	53	90
Delicates	40°-30° COLD	Delicate fabrics, for example curtains.	STAIN PREWASH TIME SAVER EXTRA RINSE RINSE HOLD SPIN SPEED	3 kg	0.50	57	58
Wool/silk 	40°-30° COLD	Wool, wool mixtures, silk and handwash.	RINSE HOLD SPIN SPEED	2 kg	0.35	50	57

In compliance with EC directive 92/75, the consumption figures indicated on the energy label refer to the "ECONOMY 60°C" wash programme for cotton.

* The consumption data shown on this chart is to be used as a guide only, as it may vary depending on the quantity and type of laundry, on the inlet water temperature and on the ambient temperature. It refers to the highest temperature for each wash programme.

Programme chart

Special programmes

Programme	Description	Programme phases	Additional functions	Max. load	Consumption*		
					Energy kWh	Water lt.	Duration min.
Rinse	This programme can be used for rinsing hand washed garments.	3 rinses with liquid additive. Short spin. (900 rpm max)	RINSE HOLD SPIN SPEED	6 kg	0.03	50	23
Softeners	Hand washed garments to be starched or softened.	1 rinse with liquid additive. Long spin.	RINSE HOLD SPIN SPEED	6 kg	/	20	24
Drain	For emptying out the last rinse water in programmes with the Rinse Hold option	The water is emptied out.		/	/	/	2
Spin	Separate spin for cottons.	Long spin.	SPIN SPEED	6 kg	/	/	13
Delicate spin	Separate spin for easy cares and delicate fabrics.	Short spin. (900 rpm max)	SPIN SPEED	3 kg	/	/	6
○ /OFF		For cancelling the programme which is running or to switch the machine off.			/	/	/

* The consumption data shown on this chart is to be used as a guide only, as it may vary depending on the quantity and type of laundry, on the inlet water temperature and on the ambient temperature.

Programme chart

Timed Drying

Degree of drying	Type of fabric	Max. load	Spin speed	Drying time mins
Extra dry Ideal for towelling materials	Cotton and linen (bathrobes, bath towels etc.)	3.5 kg	1600	95-105
		1.5 kg	1600	40-50
Cupboard dry (*) Suitable for items to put away without ironing	Cotton and linen (towels, T-shirts, bathrobes)	3.5 kg	1600	85-95
		1.5 kg	1600	35-45
	Easy cares and mixed fabrics (jumpers, blouses, underwear, household linen)	2 kg	900	70-80
		1 kg	900	35-45
Iron dry Suitable for ironing	Cotton and linen (sheets, tablecloths, shirts, etc.)	3.5 kg	1600	65-75
		1.5 kg	1600	30-40

(*) The CUPBOARD DRY drying programme for cotton is the reference programme for the Energy Label data, in compliance with standard EEC 92/75.

Consumption data for timed drying

The values shown in the chart have been obtained in laboratory tests. They may vary when the appliance is used at home, but they can be used as a guide.

Degree of drying	Spin speed	Max load	Water litres	Energy kWh	Duration minutes
Cotton Extra dry	1600	3.5 kg	29	2.45	95-105
Cotton Cupboard dry	1600	3.5 kg	26	2.15	85-95
Easy cares Cupboard dry	900	2 kg	20	1.20	70-80
Cotton Iron dry	1600	3.5 kg	20	1.90	65-75

Cleaning and maintenance

After each wash

- ☞ At the end of the wash programme, pull the dispenser drawer out a little to let it dry.
- ☞ Leave the door ajar to allow air to circulate.

If the machine is not used for a prolonged period:

- ☞ Close the water tap and unplug the appliance.

Maintenance Wash

With the use of low temperature washes it is possible to get a build up of residues inside the drum.

We recommend that a maintenance wash be performed on a regular basis.

To run a maintenance wash:

- ☞ The drum should be empty of laundry.
- ☞ Select the hottest cotton wash programme.
- ☞ Use a normal measure of detergent, must be a powder (such as Ariel Futur).

Periodical cleaning

Exterior

- ☞ Clean the outside of the cabinet with soap and water only. Rinse with clean water and dry.

Important: do not use methylated spirits, solvents or similar products to clean the cabinet.

Detergent dispenser drawer

After a while, detergents and fabric softeners leave deposits in the drawer.

- ☞ Clean the drawer, from time to time, by rinsing it under a running tap. To remove the drawer from the machine, press the button in the rear left-hand corner.

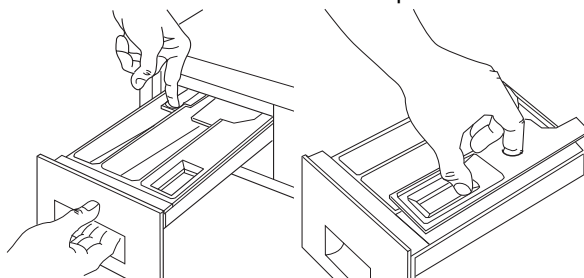

- ☞ To facilitate cleaning, the top part of the additive compartment can be removed.
- ☞ Detergent can also accumulate inside the drawer recess: clean it with an old toothbrush.
- ☞ Refit the drawer after cleaning.

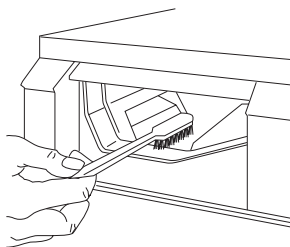

Door seal

Regularly check to see, if there are deposits or foreign objects in the rubber seal behind the door and remove them.

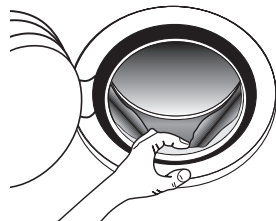

Drain pump

The pump should be inspected regularly and particularly if the machine does not empty and/or spin the machine makes an unusual noise during draining due to objects such as safety pins, coins etc. blocking the pump.

Proceed as follows:

- ☞ Disconnect the appliance.
- ☞ If necessary wait until the water has cooled down.
- ☞ Open the pump door.
- ☞ Place a container close to the pump to collect any spillage.
- ☞ Release the emergency emptying hose, place it in the container and remove its cap.
- ☞ When no more water comes out, unscrew the pump and remove it. Always keep a rag nearby to dry up spillage of water when removing the pump.

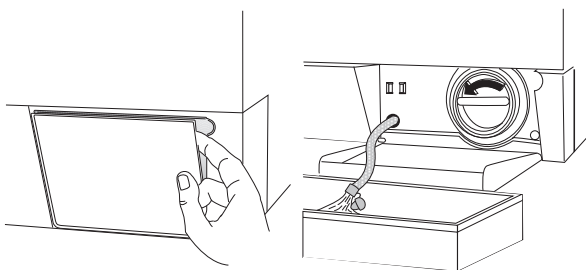

- ☞ Remove any objects from the pump impeller by rotating it.
- ☞ Put the cap back on the emergency emptying hose and place the latter back in its seat.
- ☞ Screw the pump fully in.
- ☞ Close the pump door.

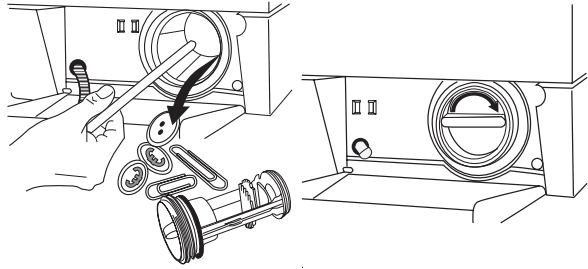

Water inlet filter

If you notice that the machine is taking longer to fill, check that the filter in the water inlet hose is not blocked.

- ☞ Turn off the water tap.
- ☞ Unscrew the hose from the tap.
- ☞ Clean the filter in the hose with a stiff brush.
- ☞ Screw the hose back onto the tap.

Emergency emptying out

If the water is not discharged, proceed as follows to empty out the machine:

- pull out the plug from the power socket;
- close the water tap;
- if necessary, wait until the water has cooled down;
- open the pump door;
- place a bowl on the floor and place the end of the emergency emptying hose into the bowl. Remove its cap. The water should drain by gravity into the bowl. When the bowl is full, put the cap back on the hose. Empty the bowl. Repeat the procedure until water stops flowing out;
- clean the pump if necessary as previously described;
- replace the emergency emptying hose in its seat after having plugged it;
- screw the pump again and close the door.

Frost precautions

If the machine is installed in a place where the temperature could drop below 0°C, proceed as follows:

- Close the water tap and unscrew the water inlet hose from the tap.
- Place the end of the emergency emptying hose and that of the inlet hose in a bowl placed on the floor and let water drain out.
- Screw the water inlet hose back on and reposition the emergency emptying hose after having put the cap on again.

By doing this, any water remaining in the machine is removed, avoiding ice forming and consequently damage to the appliance.

When you use the machine again, make sure that the ambient temperature is above 0°C.

Something not working?



If during the spin cycle the machine makes an unusual whistling noise, different from the noise made by traditional washing machines, this is due to a new type of motor.



If water is not visible in the drum, this is due to the modern technology of new washing machines that use less water than traditional machines.

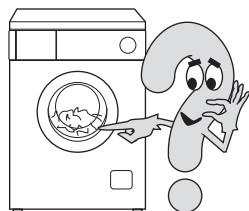

Troubleshooting

If a problem arises, you can try to solve it yourself following the instructions below.

If you call out an engineer when one of the following problems arises, or to repair a fault due to incorrect use, the call-out will be charged even if requested within the guarantee period.

During machine operation the following alarm codes may be displayed:

- **E10:** problem with the water supply
- **E20:** problem with water draining
- **E40:** door open

At the same time the END light flashes and an acoustic signal sounds. Once the problem has been eliminated, press the START/PAUSE button to restart the programme. If after all checks, the problem persists, contact your local AEG/ELECTROLUX Service Force Centre.

Problem	Possible cause	Solution
The machine does not work	The main electrical fuse or the fuse in the plug has blown.	Replace the fuse.
	The door is not properly closed (E40).	Close the door; the click of the lock should be heard.
	The plug is not connected.	Insert the plug.
	The START button has not been pressed.	Press the button.
	The DELAYED START option has been selected.	Check the selected delay on the display.
The machine does not fill	The water tap is closed (E10).	Open the water tap.
	The water inlet hose is squashed or kinked (E10).	Check the whole length of the hose and remove the kink.
	The small filter of the water inlet hose is clogged (E10).	Clean the filter.
	The door is not properly closed (E40).	Close the door.
The machine fills then empties immediately	The end of the drain hose is too low.	Place the hose at the right height (see Installation section).
The machine does not empty and/or does not spin	The drain hose is squashed or kinked (E20).	Check the whole length of the hose and remove the kink.
	The drain pump or the drain hose are clogged (E20).	Clean the pump or check the hose.
	The RINSE HOLD option (stop with water in drum) has been selected.	Empty out the water by selecting the DRAIN or SPIN programme.
	The laundry is not evenly distributed inside the drum.	Redistribute the laundry manually in the drum.

Problem	Possible cause	Solution
There is water on the floor	Too much detergent has been used.	Measure detergent according to the manufacturer's instructions.
	An unsuitable detergent has been used that creates too much foam.	Use a suitable washing machine detergent.
	One of the connectors on the water inlet hose is leaking.	Check that the hose is firmly screwed on at both ends.
	The drain pump has not been properly screwed on after cleaning.	Fully screw the pump into place.
	The cap on the emergency emptying hose has not been replaced after cleaning the pump.	Replace the cap on the emergency emptying hose after cleaning the pump.
The machine vibrates or is noisy	The transit bolts have not been removed.	Check that the machine has been unpacked as described in the Installation section.
	The feet have not been adjusted.	Carefully level the machine.
	There is little laundry in the drum.	Correct operation of the machine is not affected.
The door will not open	The programme is still running and the drum is turning.	Wait until the end of the programme before opening the door.
	The water level is above the bottom edge of the door.	Before opening the door, the water must be emptied out.
	The machine is heating the water or drying the clothes. In any case to open the door the DOOR light must green.	Wait until the end of the heating or drying phase.
The display shows the alarm code <i>EF7</i>	The water safety system starts working to prevent any flooding.	Switch the machine off, close the inlet pipe, and call the Service Force Centre.

Problem	Possible cause	Solution
Spinning starts late or the machine does not spin	The unbalance detection device that prevents excessive vibration during spinning has cut in.	<p>If the laundry is not evenly distributed inside the drum at the beginning of the spin cycle, the machine detects this and tries to redistribute it more evenly by means of a few drum rotations.</p> <p>Only when the laundry is more evenly distributed will the spin cycle be performed, at a lower speed, if the laundry is not evenly distributed.</p> <p>If, after about 15 minutes, the laundry is still tangled, the machine will not spin. Therefore, if the laundry is still wet at the end of the cycle, it is advisable to redistribute it manually inside the drum and to select the spin programme.</p>
The machine will not dry or the laundry is not dry enough	The water tap is not open (E10) .	Open the water tap.
	The drain pump is clogged.	Clean the pump.
	The drying time or degree of dryness has not been selected.	Select the required function.
	An appropriate drying time or the degree of dryness has not been chosen.	Select the appropriate drying time or degree suitable for the required degree of drying, according to the type of fabric (cottons or synthetics).
	There is too much laundry inside the appliance.	Reduce the load.

Unsatisfactory washing results

If the laundry looks grey and lime scale is found in the drum

- Too little detergent has been used.
- An unsuitable detergent has been used.
- Stubborn stains have not been treated prior to washing.
- The programme/temperature has not been correctly selected.

If grey stains remain on the laundry

- Laundry stained with ointments, grease or oil has been washed with an insufficient amount of detergent.
- The temperature selected for the wash programme was too low.
- Fabric softener - especially the concentrated type - has come into direct contact with the laundry. Wash these stains immediately and pour fabric softener carefully.

Foam is still visible even after the last rinse

- Modern detergents often produce foam, even in the last rinse. However the laundry has been completely rinsed.

White residue is left on the laundry

- This is due to insoluble components in modern detergents and is therefore not the result of insufficient rinsing. Shake or brush the laundry. In future, it may be better to turn garments inside out before washing them. Check the choice of detergent; try using liquid detergents.

Technical data

Height x Width x Depth	84x60x60 cm
Depth with door opened	101.5 cm
Height adjustment	± 10 mm approx.
Net weight	84 kg approx.
Load (depending on programme)	7 kg
Use	domestic
Drum speed during washing	max. 55 rpm
Drum speed during spinning	1600/1200/900/700 rpm
Water pressure	0.05-0.8 MPa

- CE** This appliance complies with the following EC directives:
- 73/23/EEC of 19.2.1973 "Low voltage directive", including directive 93 / 68 / EEC
 - 89/336/EEC of 3.5.1989 "Electromagnetic Compatibility Directive".

Service & Spare Parts

If after carrying out the necessary checks there is still a fault with your appliance please contact your local AEG/ELECTROLUX Service Force Centre.

In guarantee customers should ensure that the suggested checks in the "Troubleshooting" section have been made as the engineer will make a charge if the fault is not a mechanical or electrical breakdown.

Please note that proof of purchase is required for in-guarantee service calls.

Service & Spare Parts

If you require a service engineer or wish to purchase spare parts, contact your local AEG/ELECTROLUX Service Force Centre, by telephoning:

08705 929 929

For the address of your local Service Force Centre and further information about Service Force, please visit the website at www.serviceforce.co.uk.

For Customer Service in The Republic of Ireland please contact us at the address below:

AEG/ELECTROLUX
Electrolux Group (Ire) Ltd
Long Mile Road
Dublin 12
Republic of Ireland
Tel: + 353 (0) 1 4090754
email: service.eid@electrolux.ie

Help us to help you

Please determine your type of enquiry before telephoning. When you contact us we need to know:

1. Your name, address and post code.
2. Your telephone number.
3. Clear and concise details of the fault.
 - What is the fault?
 - When does the fault occur?
 - Does the multi-display issue an error-message (E and a number)?
4. The model, production number and production identification number.
5. Date of purchase.

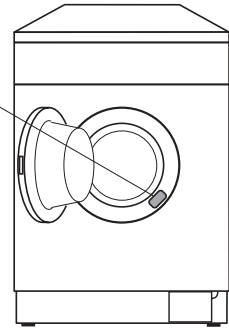
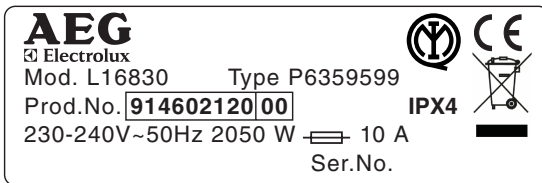

This information can be found on the rating plate, so you have these numbers to hand we recommend you write them below.

Prod. No.

Ser.-No.

Customer care

For general enquiries regarding your AEG/ELECTROLUX appliance, or further information on AEG/ELECTROLUX products please contact our Customer Care Department at the address below or visit our website at www.aeg.co.uk.

Customer Care Department
AEG/ELECTROLUX Major Appliances
Addington Way
Luton
Bedfordshire LU4 9QQ
Tel: 08705 350350*

* Calls to this number may be recorded for training purposes.

Standard Guarantee Conditions

We, AEG/ELECTROLUX, undertake that if within 12 months of the date of the purchase this AEG/ELECTROLUX appliance or any part thereof is proved to be defective by reason only of faulty workmanship or materials, we will, at our discretion repair or replace the same FREE OF CHARGE for labour, materials or carriage on condition that:

- The appliance has been correctly installed and used only on the electricity or gas supply stated on the rating plate.
- The appliance has been used for normal domestic purposes only, and in accordance with the manufacturer's operating and maintenance instructions.
- The appliance has not been serviced, maintained, repaired, taken apart or tampered with by any person not authorised by us.
- All service work under this guarantee must be undertaken by a Service Force Centre. Any appliance or defective part replaced shall become the Company's property.
- This guarantee is in addition to your statutory and other legal rights.
- Home visits are made between **8.30am and 5.30pm** Monday to Friday. Visits may be available outside these hours in which case a **premium** will be charged.

Exclusions

This guarantee does not cover:

- Damage or calls resulting from transportation, improper use or neglect, the replacement of any light bulbs or removable parts of glass or plastic.
- Costs incurred for calls to put right an appliance which is improperly installed or calls to appliances outside the United Kingdom.
- Appliances found to be in use within a commercial environment, plus those which are subject to rental agreements.
- Products of AEG/ELECTROLUX manufacture which are not marketed by AEG/ELECTROLUX.

European Guarantee

If you should move to another country within Europe then your guarantee moves with you to your new home subject to the following qualifications:

- The guarantee starts from the date you first purchased your product.
- The guarantee is for the same period and to the same extent for labour and parts as exists in the new country of use for this brand or range of products.
- This guarantee relates to you and cannot be transferred to another user.
- Your new home is within the European Community (EC) or European Free Trade Area.
- The product is installed and used in accordance with our instructions and is only used domestically, i.e. a normal household.
- The product is installed taking into account regulations in your new country.

Before you move please contact your nearest Customer Care centre, listed below, to give them details of your new home. They will then ensure that the local Service Organisation is aware of your move and able to look after you and your appliances.

France	Senlis	+33 (0)3 44 62 29 29
Germany	Nürnberg	+49 (0)800 234 7378
Italy	Pordenone	+39 (0)800 11 75 11
Sweden	Stockholm	+46 (0)8 672 53 60
UK	Luton	+44 (0)8705 350350

Instructions for installation and electrical connection



Safety instructions for the installer

- This appliance is heavy, care should be taken when moving it.
- When unpacking the appliance, check that it is not damaged. If in doubt, do not use it and contact the retailer.
- All internal packing must be removed before using the appliance. Serious damage may be caused to the machine or adjacent furniture if the protective transit devices are not completely removed. Refer to the relevant paragraph.
- Any electrical work required to install this appliance must be carried out by a qualified electrician or competent person.
- Any plumbing work required to install this appliance must be carried out by a qualified plumber or competent person.
- After having installed the machine, check that it is not standing on its electrical supply cable.
- If the appliance is placed on a carpeted floor, ensure that air can circulate freely between the adjustable feet and the floor.
- The installation should comply with local water authority and building regulations requirements.
- Should the appliance power supply cable need to be replaced, this should be carried out by our Service Force Centre.

Dimensions of the appliance

Front view and side view

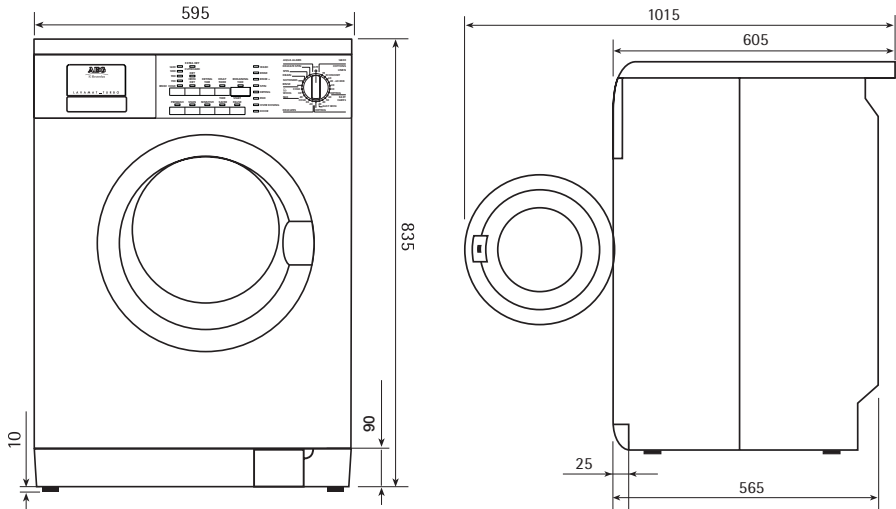

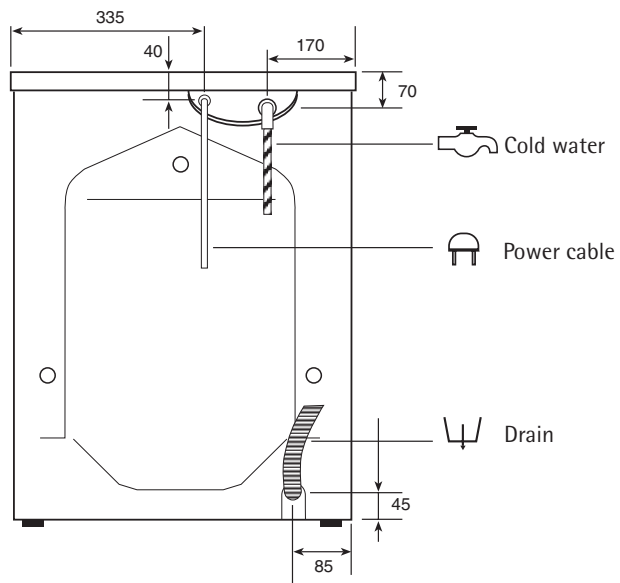

Rear view



Installation

Unpacking

 All transit bolts and packing must be removed before using the appliance.

 Using the supplied spanner, unscrew and remove the 2 rear bottom screws. Slide out the 2 plastic pins. Lay the machine on its back, taking care not to squash the hoses. This can be avoided

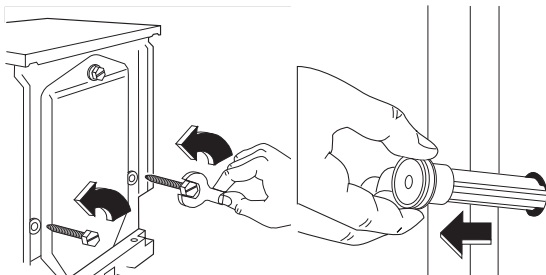

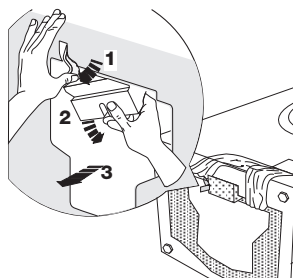

by placing one of the corner packing pieces between the machine and the floor.

 Remove the polystyrene block from the bottom of the machine and release the two plastic bags.



 Carefully slide out the left-hand bag removing it towards the right and then downwards.

 Slide out the right-hand bag removing it towards the left and then upwards.

 The bottom cover plate, which can be found inside the machine with the instruction book, will now need to be fitted. Hook the bottom of the plate 'A',

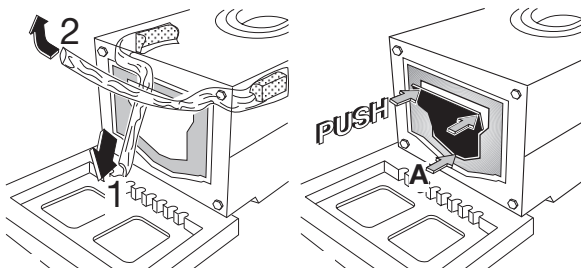



into position first. Then push the other end of the plate into position.

Important!

You can find more detailed instructions regarding the bottom cover assembly in its relative bag.

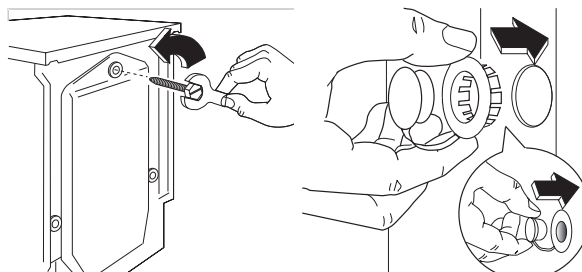
-  Set the machine upright and remove the remaining rear screw. Slide out the relevant pin.



-  Plug the open holes with the plugs which you will find in the plastic bag containing the instruction booklet.

You are advised to keep all transit devices so that they can be refitted if the machine ever has to be transported again.

Positioning

Install the machine on a flat hard floor.

Make sure that air circulation around the machine is not impeded by carpets, rugs etc.

- Before placing it on small tiles, apply a rubber coating.
- Never try to correct any unevenness in the floor by putting pieces of wood, cardboard or similar materials under the machine.
- If it is impossible to avoid positioning the machine next to a gas cooker or coal-burning stove, an insulating panel (85x57 cm) covered with aluminium foil on the side facing the cooker or stove, must be inserted between the two appliances;
- The machine must not be installed in rooms where the temperature can drop below 0°C.
- The water inlet hose and the drain hose must not be kinked.
- Please ensure that when the appliance is installed, it is easily accessible for the engineer in the event of a breakdown.

Levelling

Carefully level by screwing the adjustable feet in or out. Never place cardboard, wood or similar materials under the machine to compensate for any unevenness in the floor.

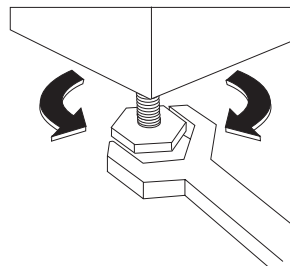

Installation on a suspended floor

Suspended wooden floors are particularly susceptible to vibration. To help prevent vibration we recommend you place a waterproof wood panel, at least 15 mm thick under the appliance, secured to at least 2 floor beams with screws. If possible install the appliance in one of the corners of the room, where the floor is more stable.

Water inlet (cold water connection only)

Connect the hose to a tap with a 3/4" thread. Installation should comply with local water authority and building regulations' requirements.

The inlet hose is provided with a water stop device, which protects against damage caused by water leaks in the hose which could develop due to natural ageing of the hose. This fault is shown by a red sector in the window "A". Should this occur, turn the water tap off and refer to your Service Force Centre to replace the hose.

Set the hose correctly by loosening the ring nut. After positioning the inlet hose, be sure to tighten the ring nut again to prevent leaks.

Do not connect to a hot water supply.

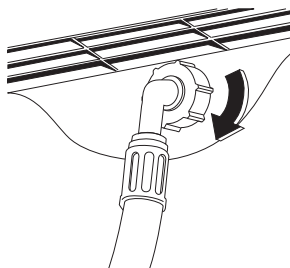
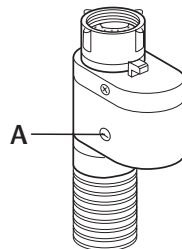

Water drainage

This appliance is designed to be permanently plumbed into your home's drainage system using one of the following methods.

1. Into a drainage standpipe.

Firstly form a hook in the end of the drain hose using the "U" piece" supplied.

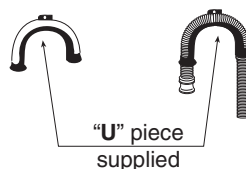

Place the drain hose into your standpipe, which should have an internal diameter of approximately 38mm thus ensuring there is an air break between the drain hose and standpipe.

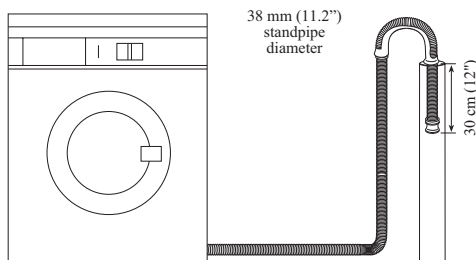

When discharging into a standpipe ensure that the top of the standpipe is no more than 90 cm (35.4") and no less than 60 cm (23.6") above floor level.

The drain hose may be extended to a maximum of 4 metres.

An additional drain hose and

joining piece is available from your local Service Force Centre. The joining piece must have an internal diameter of 18 mm.

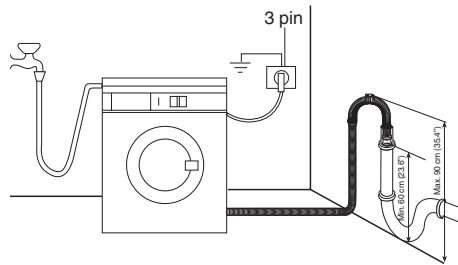

2. Onto a sink outlet spigot.

If the outlet spigot has not been used before, remove any blanking plug that may be in place.

Push the drain hose onto the spigot and secure with a clip if required, ensure a

loop is formed in the drain hose (see diagram) to prevent waste from the sink entering the washing machine.

The drain hose may be extended to a maximum of 4 metres. An additional drain hose and joining piece is available from your local Service Force Centre. The joining piece must have an internal diameter of 18 mm.

If you intend the drain hose from the machine to empty into a sink, make sure that the sink is empty and the plug hole is not blocked. Use the plastic "U -Piece" supplied.

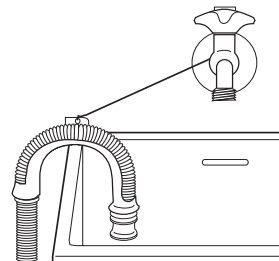
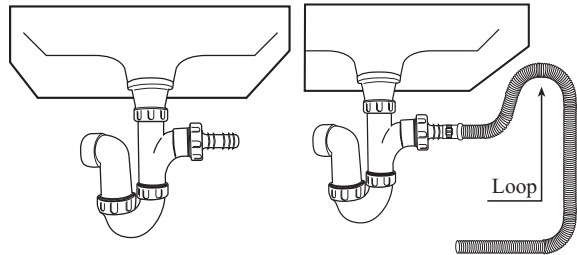

Important

Before connecting up the machine to new pipework or to pipework that has not been used for some time, run off a reasonable amount of water to flush out any debris that may have collected in the pipes.

In the interest of the environment

Washing machines and dishwashers should be connected to the FOUL drainage system, the water will then be taken to a sewage works for treatment before being discharged safely into a river.

It is essential that these appliances are not connected to the surface water drainage system as this water is discharged directly into a river or stream and may cause pollution.

If you require any further advice please contact your local water authority.

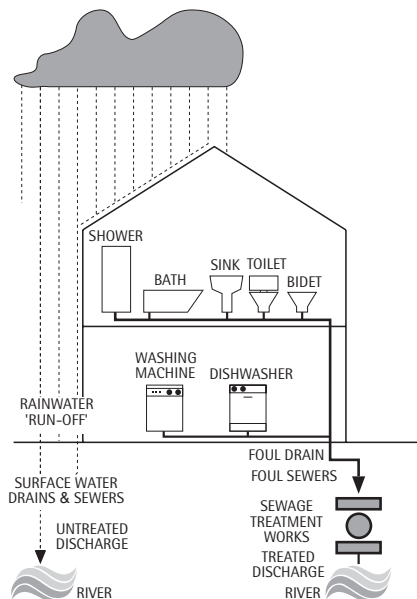

Electrical connections



WARNING: THIS APPLIANCE MUST BE EARTHED.

The manufacturer declines any liability should this safety measure not be observed.

If the plug that is fitted to your appliance is not suitable for your socket outlet, it must be cut off and the appropriate plug fitted.

Remove the fuse from the cut off plug.

The cut off plug should then be disposed of to prevent the hazard of shocks in case it should be plugged into a 13 Amp socket in another part of your home.

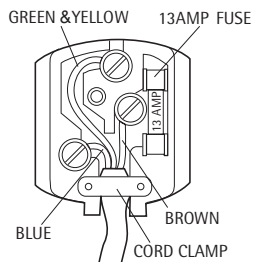

Important

The wires in the mains lead are coloured in accordance with the following code:

- Green and Yellow - Earth
- Blue - Neutral
- Brown - Live

If you fit your own plug, the colours of the wires in the mains lead of your appliance may not correspond with the markings identifying the terminals in your plug, proceed as follows:

Connect the green and yellow (earth) wire to the terminal in the plug which is marked with the letter «E» or the earth symbol \perp or coloured green and yellow.

Connect the blue (neutral) wire to the terminal in the plug which is marked with the letter «N» or coloured black.

Connect the brown (live) wire to the terminal in the plug which is marked with the letter «L» or coloured red.

The plug moulded on to the lead incorporates a fuse. For replacement, use a 13 Amp BS1363 fuse. Only ASTA or BSI approved fuses should be used.

The plug must not be used if the fuse cover/carrier is lost. The cover/carrier is indicated by the coloured insert at the base of the plug.

A replacement cover/carrier must be obtained from your local AEG/ELECTROLUX Service Centre.

The power supply cable must be easily accessible after installing the machine.

Permanent connection

In the case of a permanent connection it is necessary that you install a double pole switch between the appliance and the electricity supply (mains), with a minimum gap of 3 mm between the switch contacts and of a type suitable for the required load in compliance with the current electrical regulations.

The switch must not break the yellow and green earth cable at any point.

This operation should only be performed by a qualified electrician.

AEG Hausgeräte GmbH
Postfach 1036
D-90327 Nürnberg

<http://www.aeg.hausgeraete.de>

132.984.060-01-0605 Subject to change without notice



From the Electrolux Group. The world's No. 1 choice.

The Electrolux Group is the world's largest producer of powered appliances for kitchen, cleaning and outdoor use. More than 55 million Electrolux Group products (such as refrigerators, cookers, washing machines, vacuum cleaners, chain saws and lawn mowers) are sold each year to a value of approx. USD 14 billion in more than 150 countries around the world.

© Electrolux plc 2005