

Operating Instructions

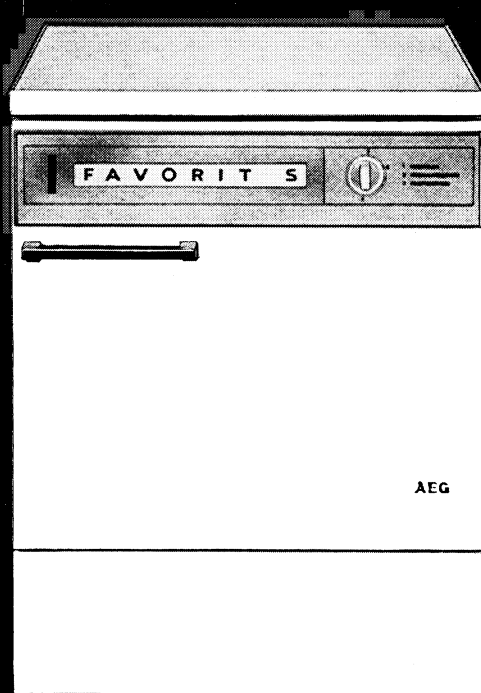

AEG FAVORIT S

In selecting the

AEG

FAVORIT S

Dishwasher

you have acquired a top-class model of modern washing-up technique. You can be congratulated on this excellent choice.

One of the most troublesome and unpleasant kitchen jobs is now a thing of the past, because now your AEG FAVORIT will do the work that used to tie you to the kitchen day after day.

After a meal you can now relax and devote your time to your family or guests while the AEG FAVORIT sees to it that your dishes are washed and dried hygienically and sparkling clean.

This little booklet will help you soon to become fully familiar with your AEG-FAVORIT.



List of contents

| | |
|---|------------|
| Installation and connections | page 4/5 |
| Demonstration of operation | page 6– 9 |
| Loading the dishwasher | page 10–12 |
| Dish washing agents | page 13–15 |
| Water softening | page 16–17 |
| Wash programmes | page 17–21 |
| Care and maintenance | page 21–24 |
| Installation or building-in and plumbing (hints for the expert) | page 25–32 |
| Conversion Chart (mm to inches) | page 33 |

Installation The AEG FAVORIT Dishwasher can be installed wherever an electrical point, water supply and drainage are provided. It can be placed in line with other kitchen units or built into fitted kitchen cabinets. For further details of the built-in model see pages 27 to 31.

Electrical Connection The AEG FAVORIT is supplied for connection to either 240 V a. c. or 220 V a. c.

| Voltage | Total connected load | Heating | Fusing |
|-----------------------------|----------------------|---------|-----------------|
| 240 V a. c. (p + mw + e) | 3.1 kW | 2.8 kW | 13 or 15 Amp |
| 220 V a. c. (p + mw + e) | 3.3 kW | 3.0 kW | 15 Amp |

The AEG FAVORIT is supplied with a 3-core supply lead which is 2 m (6' 6") long. It must be connected to a properly fitted socket of the earthed type. In view of the connected load of 3.1 (3.3) kW, the wiring must be protected by a 13 or 15 Amp fuse.

If in any doubt about the electrical connection of your AEG Dishwasher, consult a competent electrician because proper wiring is a prerequisite for our guarantee.

Water Supply In the AEG FAVORIT water is taken in through the pressure hose provided which is connected to a domestic cold water tap by a threaded coupling cup. The incorporated strainer should be cleaned from time to time. Two washers of different thickness are also supplied which can be used in the coupling cup as required. The water tap must have a $\frac{3}{4}$ " threaded end.

When the dishwasher is permanently connected to the plumbing system, it is also important that the appropriate requirements for "Drinking water supplies for plots of building land" are observed. This stipulates that a vent and a non-return valve should be located in the water inlet, unless the tap itself is furnished with these.

The two inlet valves of the AEG Dishwasher are fitted with automatic flow regulators which maintain a flow of about 5 litres (9 pints) per min. (direct flow valve) or about 1 litre (1.75 pints) per min. (regenerator valve) when water pressure is between 1 and 10 atm (15 to 150 psi). In the case of the water pressure exceeding 10 atm (150 psi), a pressure reducing valve must be incorporated between the machine and the water supply (valve, type AD 723, E-No. 612 896 723).

Each AEG FAVORIT is provided with a suds pump for drainage. It delivers the water to any drain up to 1 m (39") above floor level.

Water Drainage

The drainage hose with the discharge knee is hooked over the sink, unless permanent drainage connection is contemplated.

The discharge knee must not be immersed in the water which is being discharged, or else reverse suction into the dishwasher or unintended emptying of the dishwasher (siphon effect) could occur while the wash programmes are being carried out. Should you find any remainders of water in your dishwasher when first unpacked – this is due to the very thorough testing to which each dishwasher is subjected before leaving the factory.

In order that you are really satisfied with your modern domestic appliance, we attach great importance to the fact that a qualified person makes you familiar with the way the appliance works and how it has to be operated. This demonstration should be provided by the retailer from whom you purchased the machine.

Demonstration of Operation

Preparing the Dishes

Before loading the dishwasher, remove insoluble and hard items, such as bones for example and starchy left-overs of potatoes or porridge. Also remainders of spinach, coffee grounds, tea leaves, lettuce, fruit peel or cigarette ash should be removed from the dishes.

Saucepans and other kitchen utensils should be prepared for washing in the usual manner, i. e. saucepans with remainders of food sticking to the bottom should first be soaked in water, possibly with the addition of a little dish washing agent.

Always arrange the dishes in the baskets as shown in the illustrations on pages 10 and 11. This ensures that the water can spray all parts of the dishes thoroughly.

Correct loading is a prerequisite for the superb washing performance of the AEG FAVORIT.

Deep vessels, such as basins, cups and similar items should be placed so that all water can run off enabling them to dry properly.

Make sure also that each item rests firmly in the racks. This applies in particular to small light articles, for they must remain firmly in place to withstand the powerful water jets during the cleaning process.

When the dishwasher is loaded, make sure that the sprayer arms can revolve freely without being obstructed by any crockery.

Programme Selector Switch

The programme selector is turned clockwise to the setting corresponding to the wash programme required. It engages at the various positions.

The dishwasher is turned on by pulling out the switch. The quantity indicator for the clear-rinse agent (window) lights up.

While the dishwasher is in action, the switch handle rotates indicating the respective phases of operation. It stops temporarily while the water is heated for the wash and clear-rinse operations until the required temperature is reached.



When the programme is finished, the FAVORIT switches itself off. Depress the programme selector to switch off the electricity (the light of the quantity indicator goes out).

If you wish to interrupt a programme which has already started or if you want to change over to another programme, switch off, by depressing the selector switch, select another programme and switch on again by pulling the sector switch towards you.

Pull the door handle near the panel on the front of the dishwasher upwards and the door opens.

Opening the Dishwasher

The AEG FAVORIT has a special safeguard against inadvertent opening of the door. As soon as the handle is manipulated, the dishwasher switches off even before the door is opened. As soon as the door is closed and locked again, the interrupted programme continues automatically.

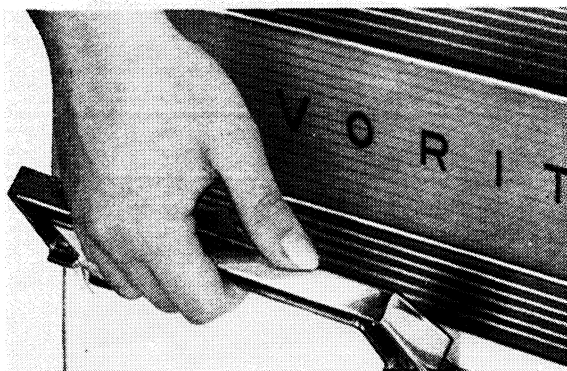

To close the door, press it firmly against the body of the dishwasher and push the handle downwards.

The programme cannot of course be switched on while the door is open. This is prevented by a special safety device.

Please, do not open the door after the wash cycle has started, or else the wash result will be affected.

Motor Protection

In the case of the circulating pump motor being overloaded, the incorporated thermal overload protection responds by switching off the motor. If this happens repeatedly, an AEG service engineer should be called.

**This is how the
AEG dishwasher
looks inside**

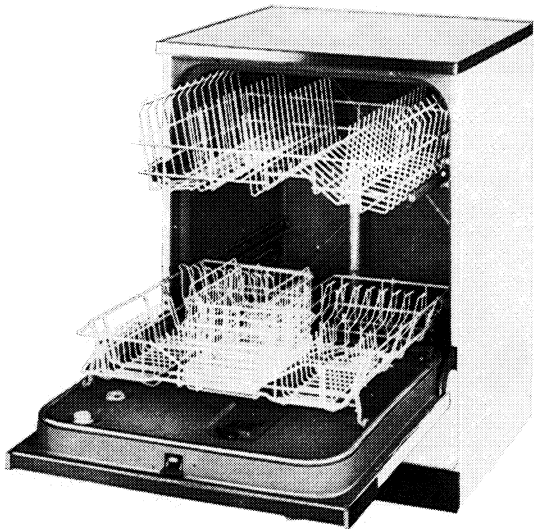

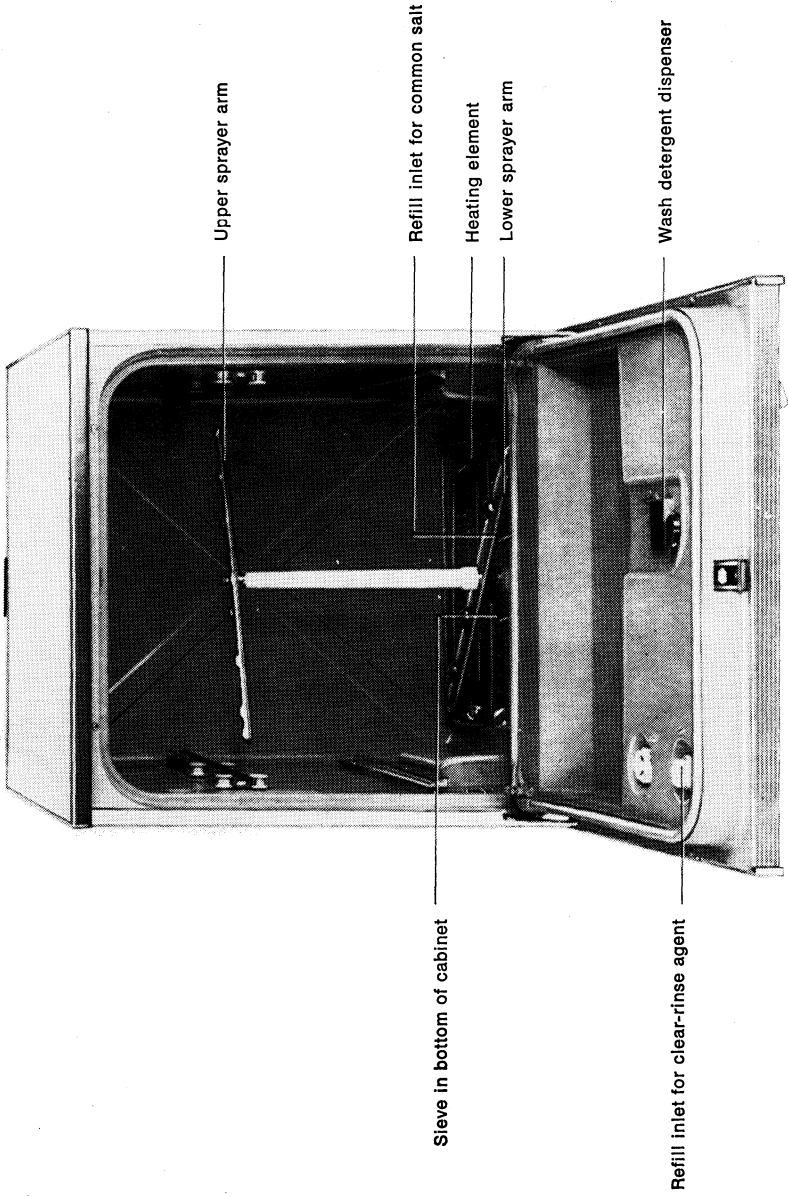

**This is how to load
the AEG FAVORIT
correctly – only the
cutlery basket has
to be removed**

Draw the lower rack towards you until it stops. It is designed especially for large items, such as plates, basins and saucepans.

Place large dinner and soup plates at the back on the right and left with the eating surfaces facing the centre, as shown in the illustration.

The front section should be loaded to the right and left of the cutlery basket with smaller plates, saucers or dessert dishes.

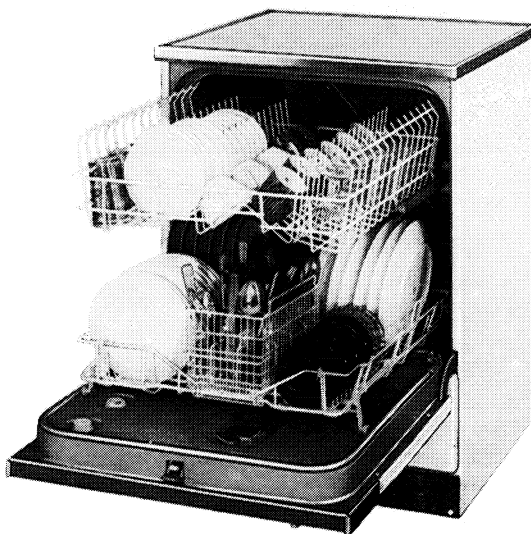

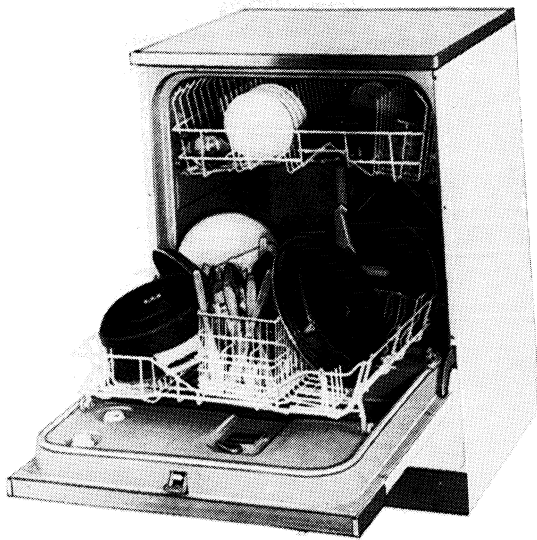

In order to be able to arrange basins, large dishes, saucepans and similar items more easily, the right-hand basket of the lower rack can be lifted out completely. Always place basins and saucepans with the inside facing down. After loading the lower rack, let it glide back as far as it will go. It will then automatically be pushed further when the door is closed.

Cutlery goes into the special basket and should be spaced in such a way that they do not nest together. For better spacing, spoons and knives should stand on their handles. The eating surfaces of spoons should not nest together. Large spoons and cutlery with long handles can be placed in the upper rack.

The cutlery basket is provided with partitions which prevent the cutlery falling into each other since silver cutlery must be washed separately from other cutlery (see page 20).

Also the upper rack can be drawn out until it stops. As shown in the illustration, it is suitable for cups, saucers, glasses, small jugs and other small items, possibly also small basins.

After loading the dishwasher, make sure that the sprayer arms can rotate freely. They must not be obstructed by any dishes.

Dish Washing Agents

Good branded dish washing agents are a prerequisite for the first-class performance of the FAVORIT. Please use only the special dish washing agents offered by the detergent industry for family dishwashers. Detergents for washing-up by hand, even if they have similar-sounding names, are not suitable for automatic dishwashing.

Two different washing-up agents are required:

The **cleansing agent** (powder) which helps the water to dissolve and remove food particles; and the **clear-rinse agent** (liquid) which reduces surface tension of the water during the "clear-rinse" programme so that the water can run off the dishes easily without leaving streaks, but leaving sparkling clean surfaces.

Suitable agents:

| Cleansing agent | Clear-rinse agent | Distributor |
|-----------------|--------------------------|---|
| Finish | Glee-rinse | Soilax Ltd., 810/811 Oxford Avenue, Trading Estate, Slough, Bucks. |
| Sun | Sun rinse aid | Lever Bros. Port Sunlight Cheshire |
| Relavit | Relaxin | Reddish Detergents Ltd. Stanley Road, Cheadle Hulme Cheadle, Cheshire |
| Fenomatic | Fenomatic rinse shine | Ian Marshal, P. O. Box 23, Weybridge, Surrey. |

The cleansing agent in powder form is poured into the dispenser situated on the inside door panel on the right, from where it will be released automatically at the right moment. After the powder is poured into the dispenser, the lid is closed by turning it anticlockwise.

Adding the Cleansing Agent

If the dispenser happens to be closed before the cleansing agent has been added, the lid can be opened by turning the stop lever, in which case it opens automatically.

Gauging the cleansing agent: approximately 2 heaped tablespoons. In the case of less soiled dishes, less powder may be sufficient. You will soon find out which quantity you need for your dishes and for obtaining best results.

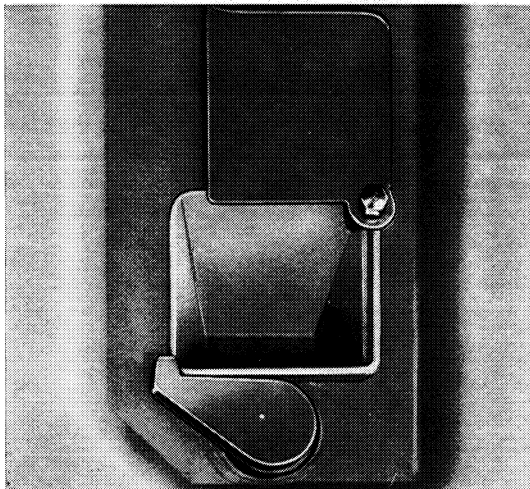

Filling the Clear-Rinse Agent Container

An automatic dosing device for the clear-rinse liquid is built into the inside door panel on the left. The container holds approximately 200 ccm clear-rinse liquid which is sufficient for approximately 50 programmes.

A quantity indicator which is illuminated is located on the left-hand side of the panel. The indicator lights up as soon as the programme selector is pulled to switch on the dishwasher. It does not go out until the selector switch is pushed back after the wash programme is completed, or until the door is opened.

It is advisable to refill the clear-rinse agent container as soon as the level in the indicator has sunk to the lower edge of the indicator window.

To refill the container, open the filler cap of the refill inlet on the inside door panel.

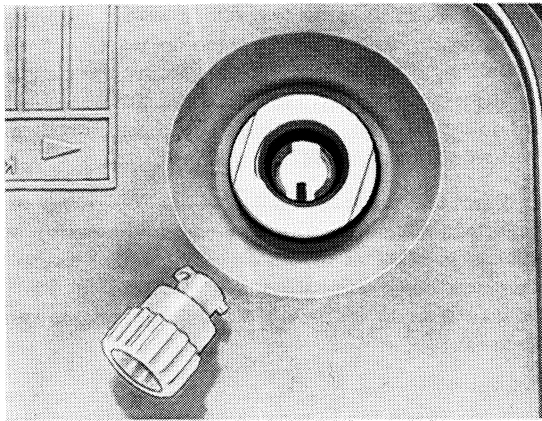

Fill up with clear-rinse agent only as far as the lower end of the filler tube (this corresponds to a level in the indicator about 1 cm [$\frac{1}{2}$ " appr.] below the top). Close filler cap tightly.

Make sure that you do not spill anything during re-filling, or else excessive foaming may be caused during the next programme.

If you wish to try different clear-rinse agents, we advise you not to fill the dosing device completely the first time so that you can try another clear-rinse agent within a short period.

Cleansing or Clear-Rinse Agents are obtainable from Grocery Stores or directly from manufacturers using the coupons or order cards supplied with the dishwasher.

Water Softening

Each FAVORIT is provided with a water softening device which makes the washing-up water soft by neutralizing calcium. This helps to improve the cleansing effect considerably. Calcium stains are eliminated and during the clear-rinse programme a nice sparkle is added to your glasses and crockery.

To keep the water softening device operating effectively at all times, you simply add before each programme in addition to the cleansing agent a small quantity of common cooking salt which is poured into the special container provided at the front underneath the lower rack.

Remove the cutlery basket.

Open the screw cap of the salt container.

Add the salt, using the funnel supplied.

Close the screw cap tightly.

Everything else is done automatically by the FAVORIT.

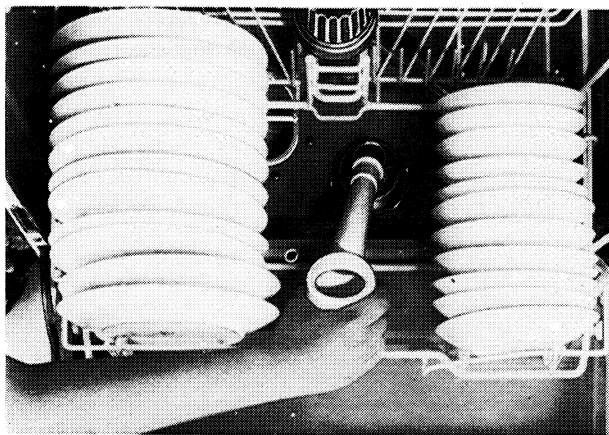
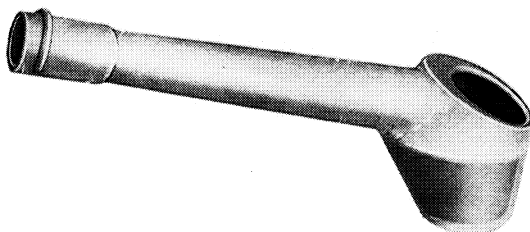

The salt funnel also provides a measure for the correct amount of salt to be added. The quantity depends on the water hardness which can be determined when the dishwasher is installed and demonstrated to you. You can also obtain information regarding the water hardness from your local water works. The following amount has to be added for a water hardness of:

up to 20° d Continental (26° English):

1 measure filled to the mark

above 20° and up to 40° d Continental (26–48°

English):

2 measures filled to the mark

Any common cooking salt of standard quality can be used. But commercial fine regenerating salts are also suitable. **Not suitable** are "dietetic salts" leaving insoluble residues, refined sea salt, cattle salt and some types of table salt containing special additives to keep the salt dry.

Please note that you always have to add two things before each programme: the cleansing agent and salt. It is recommended to store both in the same place so that neither is forgotten.

The AEG FAVORIT has a particularly effective method of washing up because it uses soft water five times in succession: twice cold water at the beginning, followed by the wash cycle with the hot detergent solution, the warm intermediate rinse and the hot clear rinse with "neutralized" water. Finally everything is dried and comes up sparkling clean.

The superb wash effect is also due to the AEG fanned-jet spray system. The fanned jets coming from the directed nozzles in the lower and upper sprayer arms reach every part of the dishes.

There are only a few things to do before and after using the AEG FAVORIT:

Arrange the crockery – replace the racks

Add cleansing agent (powder); when using the dishwasher for the first time, also fill the clear-rinse agent container, otherwise check quantity indicator.

Add salt.

Replace cutlery basket.

Close door.

Wash Programmes

Plug in the FAVORIT or in the case of permanent connection switch on main switch. Hook drainage hose over sink.

Open water tap.

Select programme. To switch on, pull selector switch. The quantity indicator window lights up, showing that the dishwasher is in operation.

When the programme is finished, the FAVORIT switches itself off.

Depress the selector switch to switch off (the light of the quantity indicator goes out).

Unplug or switch off main switch.

Close water tap.

To obtain best results with regard to the drying of the dishes, it is advisable not to remove them from the dishwasher immediately the programme has finished, but to leave them in the racks for a little while, keeping the door slightly ajar.

Cooled down, the sparkling clean crockery can now be taken out of the dishwasher and put straight into the cupboard. It is advisable first to remove the dishes from the lower rack and subsequently those from the upper rack.

Programme 1 "Pre-wash" programme

in cold water only so as to prevent food particles from drying.

No cleansing agent and no salt.

Turn selector switch to "1".

Cold water spraying action only.

When this programme is finished, press the selector switch and leave the door closed until you wish to use the dishwasher again. The complete programme "2" or "3" should not be turned on until the dishwasher is fully loaded.

Programme 2 Standard programme 55/65° C (130/150° F)

for heavily soiled dishes left after a hot meal and for all items used for preparing the meal.

(of course lightly soiled articles can be included)

Add cleansing agent and salt.

Turn selector switch to "2".

Short programme Cold/65° C (150° F)

for lightly soiled dishes, painted china, glasses, crystal glass, and sensitive plastic items.

Add cleansing agent and salt.

Turn selector switch to "3".

This programme begins with two cold wash cycles which are followed by the clear-rinse and drying cycles.

Programme 3

And this is how the programmes work:

| Programmes | 1 | 2 | 3 |
|---|------|----------------------------|----------------------------|
| Soak | cold | cold | — |
| Pre-wash | cold | cold | — |
| Wash (with cleansing agent) | — | appr. 55° C*) 130° F | cold |
| Intermediate rinse | — | appr. 30° C 86° F | cold |
| Clear-rinse (with clear-rinse agent) | — | appr. 65° C*) 150° F | appr. 65° C*) 150° F |
| Dry | — | hot | hot |

*) While the water is heated up, the programme selector switch temporarily stops rotating.

Washing-up habits

In order to use your AEG FAVORIT as economically as possible, you should change some of your washing-up habits. Always place used dishes immediately into the racks so that your kitchen always looks tidy.

If you have a small family or not much to wash up, you can use your dishwasher economically by putting your tableware straight into the machine after each meal and by waiting until it is fully loaded before setting it in operation.

If you have a large family or always a lot to wash up, it is worth your while to load the dishwasher before a meal with the kitchen utensils used for preparing the food so that they can be washed while you eat.

A few more useful hints

When you have finished your meal, all these things are already washed and dried by your FAVORIT.

Unless it is really necessary, try to avoid using excessively deep and large saucepans. This applies also to basins and large platters which take up much space in the dishwasher. It is always advisable to use two small dishes instead of a large one.

If you buy new tableware, see to it that the shapes are suitable for the dishwasher, i. e. straight, smooth walls and large openings.

Pots and Pans

Pots and pans can of course be washed very successfully in the FAVORIT. But it is essential that their surfaces are well kept and smooth. Any food particles sticking to the bottom should be soaked in water possibly with the addition of a little cleansing agent.

Cutlery

If you have modern cutlery, you can wash it in the FAVORIT without hesitation, because the handles are generally soldered on.

In the case of the old-type cutlery, the handles are probably fixed with an heat-sensitive cement which dissolves in very hot water. Knives should be placed into the basket with the handles down.

Cutlery with handles made of wood or horn are not suitable for automatic dishwashing.

Silver Cutlery

Silver cutlery can be washed in the FAVORIT without hesitation. But in conjunction with the washing-up solution it can get stained when in contact with steel cutlery. This is why the cutlery basket is provided with partitions. Do not put silver and steel cutlery into the same compartment of the basket.

Silver cutlery can tarnish also when in contact with certain sulphurous food particles, such as egg yolk or mustard, similarly when exposed to air. Treat your silver cutlery occasionally with a modern silver polish.

Aluminium

All items made of aluminium can be washed in the dishwasher. But as in the case of washing up by hand, they will darken in course of time.

However, you should see to it that aluminium ware is not placed directly below the detergent dispenser because concentrated detergent might cause heavier staining.

Painted China

Coloured designs on china are generally made by "surface-glaze painting" and to a smaller extent by "under-glaze painting". But recently also highly heat-resistant paints are used for crockery decorations which are applied to the item after the first stoving process. Designs applied by the two latter methods are not affected by the washing-up process in the dishwasher. Even when washed manually surface-glaze designs and gold decorations which are always applied onto the glaze can gradually fade due to the effect of suds, rubbing and wiping. The FAVORIT however caters for such items because it has a special short programme where the cleaning is done in cold water and only the clear rinse is carried out hot.

Crystal Glass

The short programme "3" is especially suitable for articles made of such delicate materials.

Plastic

Plastic tableware nowadays is of very different quality and varying heat resistance. Those marked "fast to boiling" can definitely be washed in the FAVORIT, even in the standard programme at a high temperature. Other plastic articles should preferably be washed in programme "3", in which case they should be placed into the upper rack.

You should always bear in mind that plastic articles do not dry as well because of their low heat absorption, they do not conduct heat well and because they are water repellent.

If in doubt ask a specialised dealer whether your plastic are resistant to heat deformation.

Kitchen and Tableware made of Wood

Cheese boards, bread boards and similar large wooden items are known to have a tendency to crack if dried too quickly. As the FAVORIT, like any other

dishwasher, dries at a high temperature, wooden articles should not be washed in the dishwasher.

Care and Maintenance Care and maintenance of your FAVORIT is very simple.

After you have used the dishwasher, close the water tap, pull out the plug or switch off at the main switch. In this way you make sure that the dishwasher cannot be switched on inadvertently.

It is advisable to leave the door of the dishwasher ajar for a short while after use; this applies also when you do not use it over a longer period, for example during your holidays.

The interior of the dishwasher cleans itself.

Clean the outside from time to time with a damp cloth, wiping it dry afterwards. Under no circumstances should you use any aggressive or coarse cleaning agents.

The plastic working top of the dishwasher is best cleaned with warm water to which a commercial cleaning agent has been added. Treat it like any other good-quality plastic surface, i. e. do not put hot saucepans onto it straight from the cooker.

Check the sieve in the bottom of the dishwasher regularly to make sure that it is clean. To do this, only remove the cutlery basket, lift out the sieve by its cross bar and, if necessary, clean it under running water and possibly with the help of a brush.

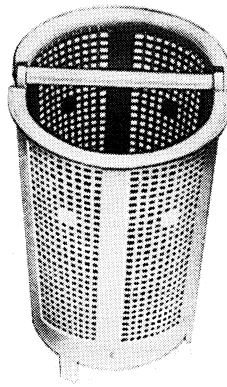

When replacing the sieve, see to it that its top edge rests firmly and tightly in the bottom of the cabinet. Under no circumstances must the FAVORIT be put into operation without the sieve.

The heating elements of the FAVORIT are made of high-quality stainless steel. Occasionally you may find that they have turned dark, which however does not impair their quality or life span.

If at any time there is anything wrong with your FAVORIT, please check the following points before calling the service engineer:

If the dishes are not clean:

- Did you use a cleansing agent suitable for dishwashers and did you add the right amount?
- Did you fill the cleansing agent container and close the lid?
- Did you load the dishwasher correctly?
- Did the dishes perhaps obstruct the sprayer arms so that they could not rotate?
- Did you, where necessary, use a pre-wash programme ("1"), especially for heavily soiled dishes?
- Did you clean the sieve and replace it properly in the bottom of the cabinet?

If the dishes are not sparkling:

- Did you use a clear-rinse agent suitable for dishwashers?
- Did you refill the clear-rinse agent container (check quantity indicator window)?
- Did you add each time sufficient salt for the water softening device?
- If this is forgotten at any time, the efficiency of the water softener can easily be restored as follows:

Do not add any cleansing agent or load the dishwasher. Lift out the cutlery basket and pour two full measures of common salt into the salt container. Turn the programme selector switch right round to the dot in the "clear-rinse" field, then pull the selector switch towards you and let the machine run until the programme is finished. Now wait for about 15 minutes before starting a new programme. By that time the dishwasher is again in full working order.

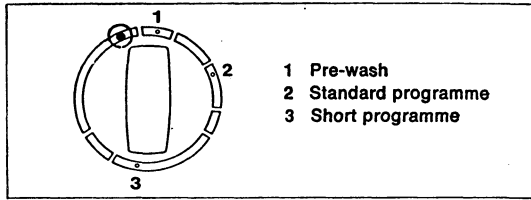

It is advisable to repeat this procedure if the water hardness in your district is above 20° d (26°) or whenever the salt has been forgotten on several occasions. In this case, however, programme "1" should be carried out between the two processes.

If the dishwasher does not start:

- Did you close the door properly and turn on the water tap?
- Did you plug in the dishwasher or switch on at the main switch?
- Did you operate the programme selector properly?
- Did you pull the selector switch towards you long enough?
- Check the fuse in your plug and, if necessary, replace.

If the dishes are not sprayed:

- Maybe the thermal-overload protection has operated, switching off the circulation pump (cf. page 8). If your dishwasher is still not working properly, please get in touch with your nearest AEG Service Agent or write to AEG (Great Britain) Ltd., Domestic Service Dept., 56/60 Hillmarton Road, London, N. 7. — Tel. 607 0951.

Connection to Hot Water Supply System

For the superb washing-up result of the AEG FAVORIT it is essential that there are two cold pre-wash cycles and that the cold "main-wash" water is heated to a very high temperature in the tub. As the cabinet is closed, the steam condenses on the crockery before the final temperature is reached. This steam treatment soaks and dissolves hard food particles especially thoroughly.

If hot water from a central hot water supply system or from other hot water appliances is fed into the dishwasher, food particles soluble in cold water especially egg white and starch, can burn on the dishes and leave stains which are difficult to remove.

The FAVORIT must therefore be connected only to cold water supplies.

1. Installation

The AEG FAVORIT is very suitable for building-in or fitting into modern kitchens because with its hidden hoses it can be placed against the wall. It is advisable to have the dishwasher installed to the right or left of the sink or draining board, depending on the position of the supply pipes.

The dishwasher is supplied with a practical work top so that it can be used as a **free-standing model**, standing by itself or in line with other kitchen units. If it is meant for **building-in**, it is supplied without the work top and side walls so that it can be fitted under an existing work top.

The **free-standing model** comes from the factory with the work top projecting 25 mm (1 in.) at the rear. This can be adjusted to different projecting lengths of other kitchen unit tops by shifting the working top up to 25 mm (1 in.) to the front. To do this only the two screws at the rear and at the front with which the top is fixed have to be loosened and tightened again after the top has been shifted.

Further, the cover of the work top can be exchanged. After loosening 4 screws at the rear underside of the work top, the rear trimming can be removed and the RIColor cover can be pulled out. [Dimensions for replacement top covers: 595 × 595 mm (23²/₅ × 23²/₅ in.), thickness 3.5 + 0.3 mm (appr. 1/6 in.)]. The loose sections of the trimming should be bent away from the edge and back again very carefully, if possible only once or twice.

If the dishwasher is installed under existing working surfaces, its height can be reduced from 850 to 820 mm (from 33¹/₂ to 32¹/₄ in.) by removing the work top.

The diagram on page 26 shows the dimensions of the free-standing model.

Installation or Building-in and Plumbing

(Hints for the expert)

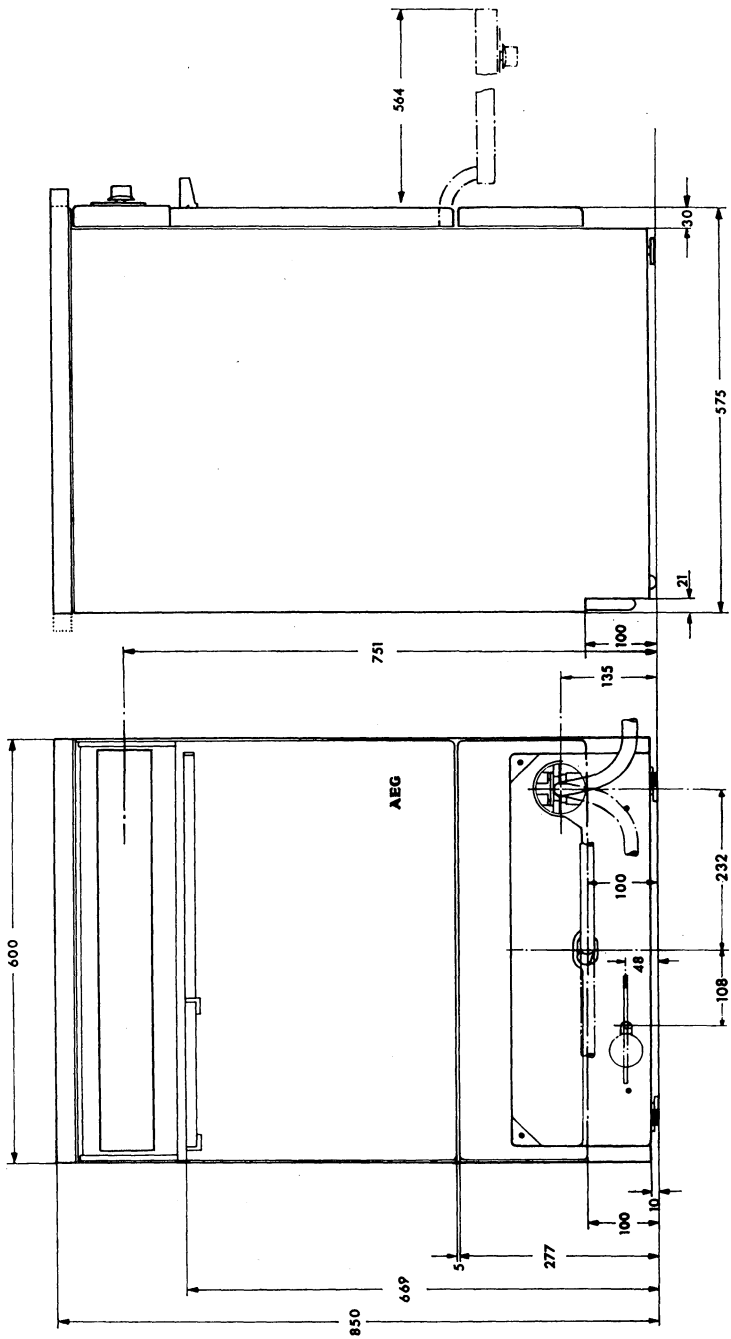

The model for **building-in** is supplied ready for fitting, i. e. without work top and with front facing angle strips instead of the side panels.

If in a fitted kitchen one side of the dishwasher is exposed, the right or left side panel can be obtained from your local AEG Office (side panel right: Et-No. 646 013 320; side panel left: Et-No. 646 013 330). The AEG FAVORIT is also provided with two slotted angle brackets to connect it with existing working surface.

The diagram on page 28 shows the dimensions of the built-in model.

The front feet of both models can be adjusted if the floor is uneven. To do this, the cabinet is tilted backwards so that it stands on its rear bottom edge. The feet can now be adjusted by loosening the hexagonal nuts. The base of the AEG FAVORIT is 100 mm (4 in.) high. In order to adjust it to other bases which are up to 180 mm (7 in.) high, a shortened exchangeable trimming can be obtained from your local AEG Office (Et-No. 608 899 801).

2. Permanent Plumbing to the Sink Unit

(see also Diagram H for built-in models)

The diagram on page 29 shows how to carry out the permanent electrical and water connections of the AEG FAVORIT with the sink unit, when installed to the right or left of the sink.

As regards the water supply connection, two examples are taken into consideration: connection with a flush valve 30 cm (12 in.) above the work top or with a valve, type GAZ 602, built into the covering.

The hoses and the electrical supply lead are connected to the dishwasher within the base recess and have to be laid above one another within this space, from where they are run either to the right or to the left.

When the hoses and the electrical supply lead are laid into the sink unit, it may be necessary to provide openings which are large enough for the hoses and the lead to be pulled out with ease when the dishwasher has to be removed for servicing.

If the feed hose provided is not long enough for permanent plumbing, it can be exchanged for a sufficiently long **continuous** pressure hose which is **resistant to pressure up to 12 atm (appr. 180 psi)**.

total depth required

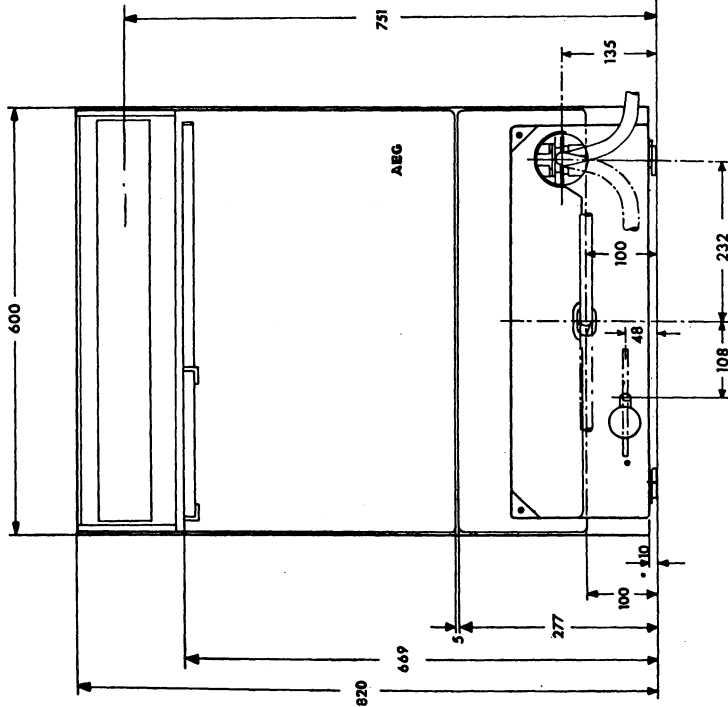
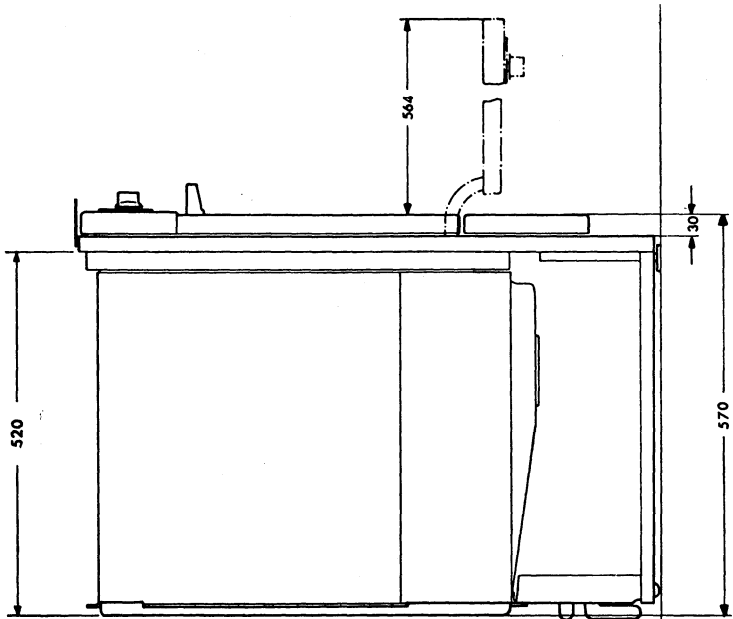

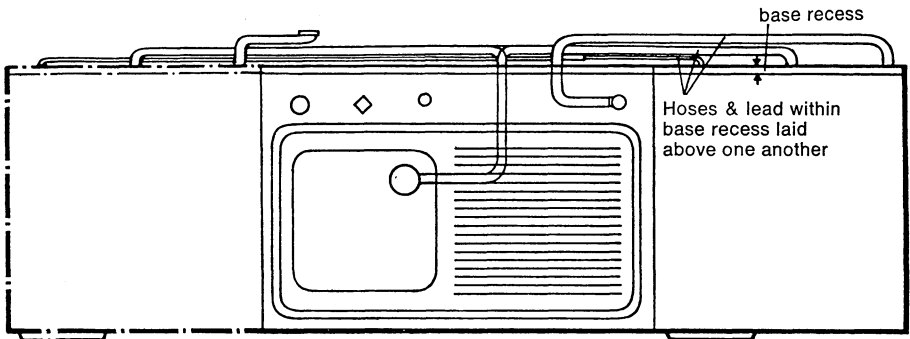
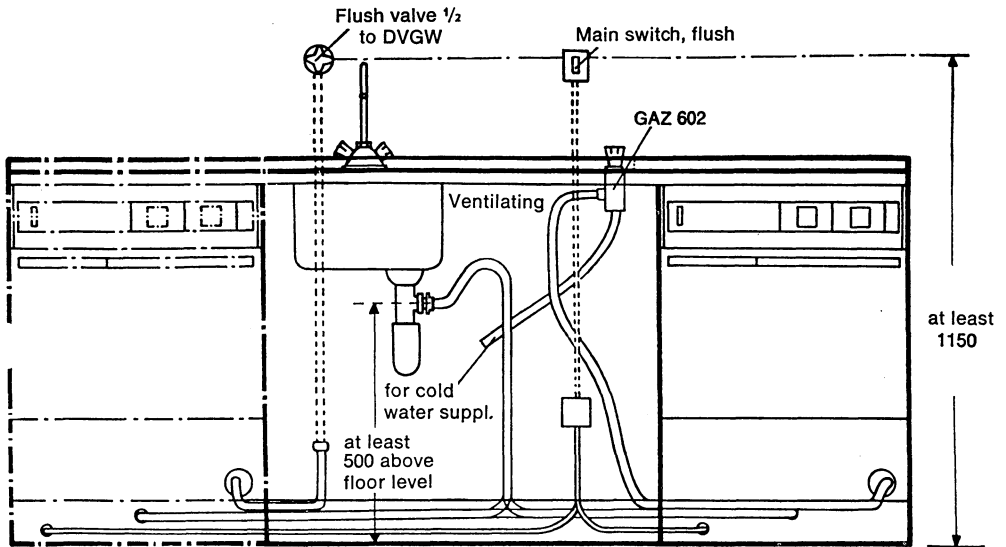

If the drainage hose is too short for permanent plumbing, it can be extended with the help of a connection piece made of stainless steel, 40×15 mm ($1\frac{1}{2} \times \frac{1}{2}$ in.) dia., and with a sufficiently long hose having an inside diameter of 15 mm ($\frac{1}{2}$ in.). Also hose clamps 21/23 mm (appr. 1 in.) are required in this case.

Supply and drainage hoses can be bought by the meter (yard) from your local AEG Office. The same applies to suitable hose clamps, 21/23 mm (appr. 1 in.). The drainage hose should not be extended by more than 5 m (16 ft.) — measured horizontally — in view of the decreasing discharge performance of the emptying pump.

As illustrated above, the connection to the water supply can be carried out with the help of a concealed pipe ($\frac{1}{2}$ ") and a flush gate valve ($\frac{1}{2}$ "), having a non-rising stem, to be fitted at least 1150 mm ($45\frac{1}{2}$ ") above the top of the dishwasher. In this case the pipe is fitted with a hose nipple or sweep ($\frac{3}{4}$ ") leading through the wall, to which the supply hose is screwed with a coupling nut.

Local regulations permitting, the connection can also be effected with the help of the angle valve, GAZ 602, E-No. 606 899 602, and a commercial T joint which has to be incorporated between the cold-water supply and the sink fittings. The flush and angle valves must be opened only while the dishwasher is in operation and closed again after the washing-up programme is finished in order that the inlet valves are not continuously under full mains pressure.

For the permanent connection of the drainage hose, as shown in the diagram on page 29, a T joint of suitable dimensions, R $1\frac{1}{2}$ or $1\frac{1}{4}$ " , or a short piece of pipe, 15 mm ($\frac{1}{2}$ in.) dia. is incorporated between sink and siphon.

The drainage hose (without discharge knee) is then connected either directly to the T joint via a suitable reducing nipple, R $\frac{1}{2}$ " or $1\frac{1}{4}$ " \times R $\frac{3}{4}$ " with the help of a screwed hose connection (diagram page 29), or to the short piece of pipe with a hose clamp 21/23 mm (appr. 1 in.).

If in the case of permanent connection, the point of connection (e. g. the siphon) is not at least 50 cm (20 in.) above floor level, then the drainage hose

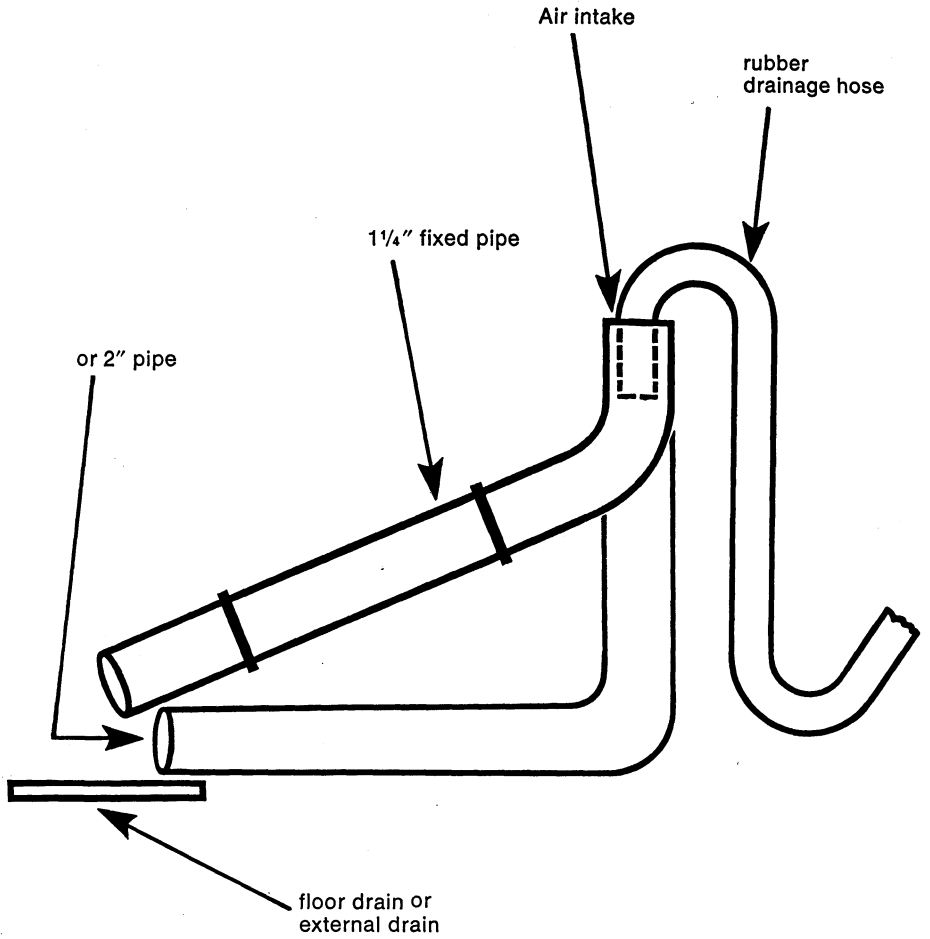

must be laid at any point above this height, or else the water would flow out through the hose by itself. It is most important that an air-vent of some description is incorporated in the drainage system. The suggested method is for a fixed pipe to be of a larger diameter than the rubber hose and positioned so that the hooked end of the rubber hose can be placed into it. See illustration on page 31.

3. Building the FAVORIT into Ceiling-Height Cupboards

The AEG FAVORIT model for building-in can also be fitted into suitable ceiling-height cupboards which have an inside width of at least 566 mm (appr. 22⁵/₁₆ in.), a wall thickness of not more than 17 mm (appr. ³/₄ in.) and which have been appropriately prepared for this purpose. The mounting board must have a bearing strength of at least 100 kg (appr. 220¹/₄ lb.) and should be not higher than 500 mm (appr. 1 ft. 6 in.) above floor level so that the upper rack of the dishwasher can still be comfortably loaded. In order to be able to run the hoses into the lower part of the ceiling-height cupboard and into adjoining fitted units, sufficiently large openings must be provided.

Also in this case the water hoses are connected to the fittings of the sink as described above, or to a specially installed fitting.

Details for mounting and plumbing the dishwasher inside a ceiling-height cupboard are evident from the diagram H 246 265 400.

To stabilize the cupboard with regard to weight proportions, it is advisable to screw the cupboard to the wall with the help of suitable angle brackets. It is further recommended to screw the ceiling-height cupboard to adjoining fitted units.

4. Electrical Connection

Page 29 shows also the electrical connection with the help of a bottom connection box and a main switch, flush at a height of at least 1150 mm (45¹/₂ in.).

After the electrical and water connections are established, the dishwasher is lifted at the front and pushed into place on its two rear castors.

When pushing the appliance into place in fitted kitchens, special care has to be taken to make sure that the electrical lead and the supply and drainage hoses are free from kinks and not squeezed.

The above instructions for the permanent connection and building-in of the dishwasher are of course recommendations given to the technician as examples without obligation. In any case, the circumstances at the place of installation, the design of the kitchen units and the specifications for connection or the regulations laid down by the local Electricity Board and Water Works are decisive for the permanent connection of the appliance.

Conversion Chart mm to inches

| mm | mm | Approx. ins | Approx. ins |
|-----|---------------------|-------------|----------------------|
| 3.5 | $\frac{1}{8}$ | 277 | $10^{\frac{15}{16}}$ |
| 5 | $\frac{3}{16}$ | 534 | 21 |
| 10 | $\frac{3}{8}$ | 564 | $22^{\frac{3}{16}}$ |
| 15 | $\frac{5}{8}$ | 570 | $22^{\frac{7}{16}}$ |
| 21 | $\frac{13}{16}$ | 575 | $22^{\frac{10}{16}}$ |
| 30 | $1^{\frac{3}{16}}$ | 595 | $23^{\frac{7}{16}}$ |
| 40 | $1^{\frac{9}{16}}$ | 600 | $23^{\frac{5}{8}}$ |
| 48 | $1^{\frac{7}{8}}$ | 669 | $26^{\frac{5}{16}}$ |
| 100 | $3^{\frac{15}{16}}$ | 751 | $29^{\frac{1}{2}}$ |
| 108 | $4^{\frac{1}{4}}$ | 820 | $32^{\frac{5}{16}}$ |
| 135 | $5^{\frac{5}{16}}$ | 850 | $33^{\frac{7}{16}}$ |
| 232 | $9^{\frac{1}{8}}$ | 1150 | $45^{\frac{5}{16}}$ |



AEG

**PERFECTION
IN YOUR
HOME**

H 245 256 540
- 0971/03 -
Subject to change
without notice