

FAVORIT 535

Dishwasher

Operating Instructions

Read this instruction booklet and keep in a safe place

The dishwasher must only be installed and connected by a specialist fitter. Our special notes for installation are given on pages 19-21.

The instructions in this book will enable you to use all the features on the machine to your best advantage, and if you spend a little time in following the instructions, your dishwasher will reward you with superb results. If you do call out a service engineer in connection with any user information contained in this booklet this call will **not** be free of charge even during the guarantee period.

Contents

Illustrations (unfold pages for easy reference)	3- 5	Unloading the dishwasher	13
Guide to machine	6- 8	Programmes	14/15
General advice on dishwashing	8	Cleaning and care	16
Setting the water hardness	9/10	If you think your machine is not working properly	16/17
Adding dishwasher salt	9/10	Service	18
Filling the rinse aid container	10	For the plumber/electrician (Installation, water and electrical connections, anti-flood system)	19-21
Setting the rinse aid dosage	11	Technical data	22
Adding detergent before every programme	11	Loading diagrams	5 and 23
Loading the dishwasher	12		
Switching on and off	13		

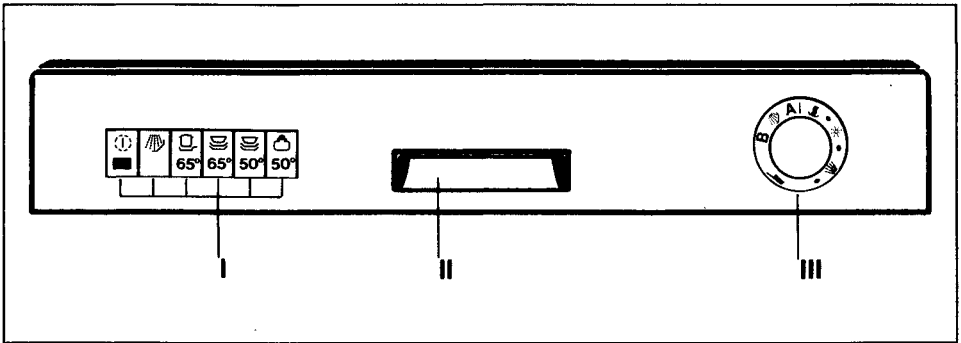

1

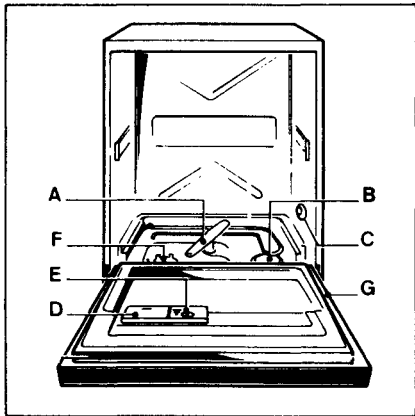

2

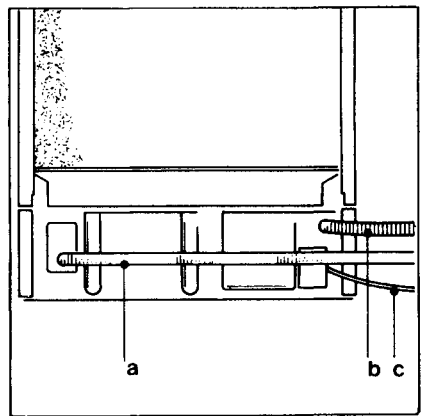

3

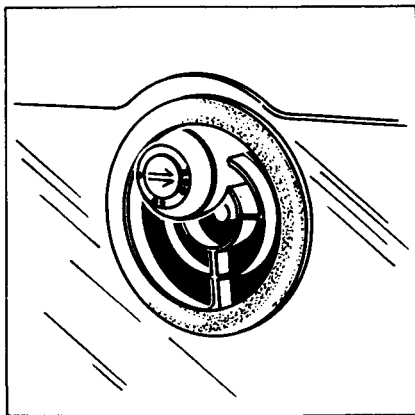

4

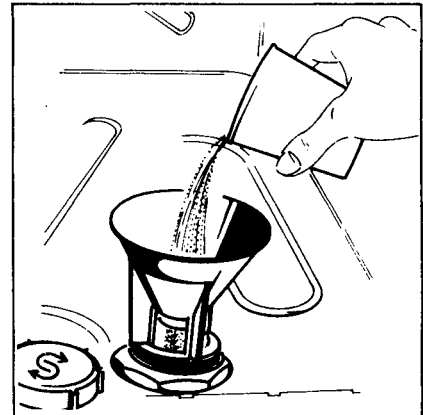

5

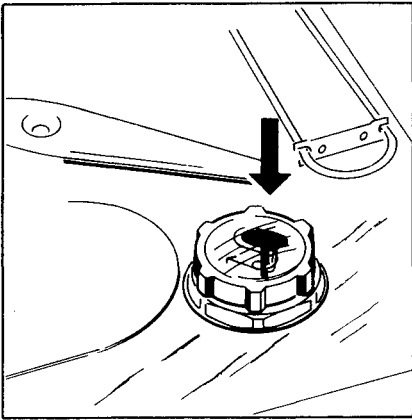

6

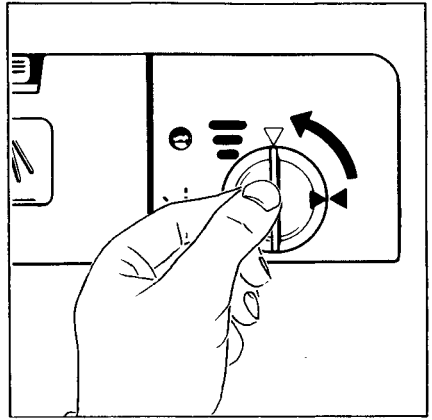

7

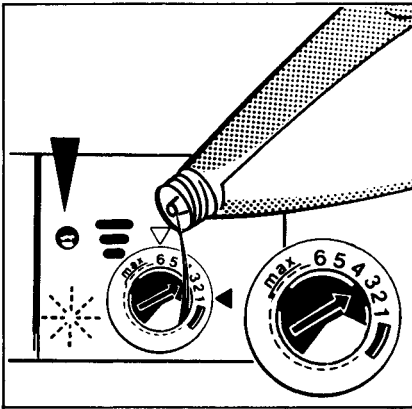

8

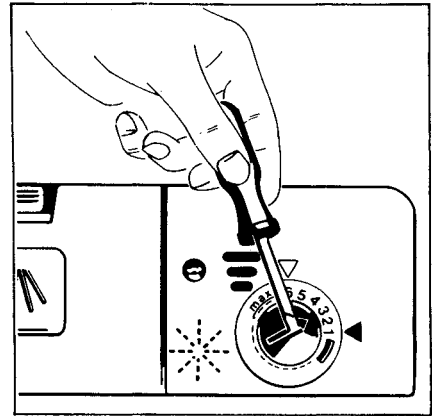

9

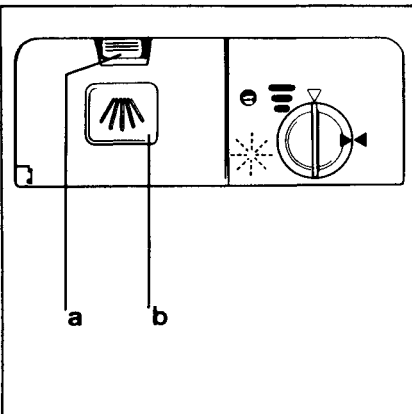

10

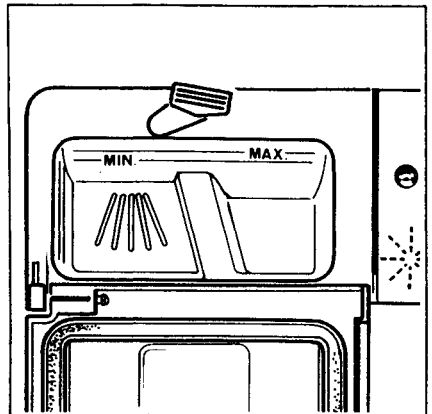

11

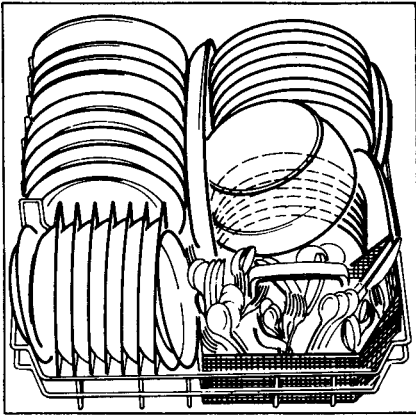

12

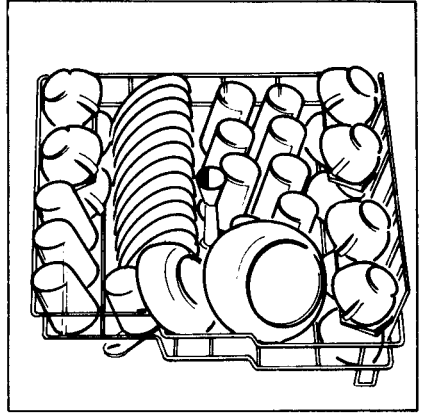

13

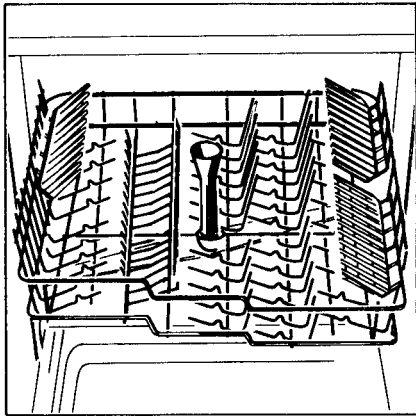

14

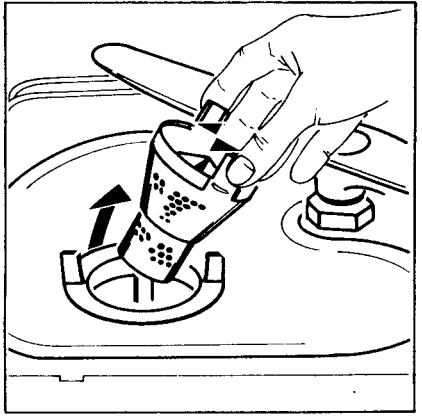

15

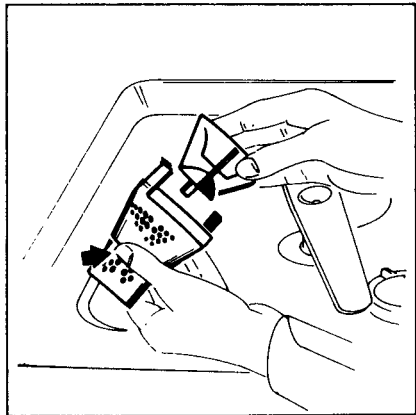

16

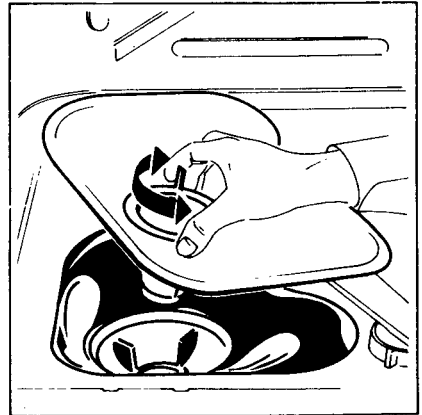

17

Guide to machine

For illustrations see pages 3, 4, 5

Control panel

Fig. 1

- I On/off and programme selector buttons
- II Door handle
- III Programme start and programme sequence indicator

Interior

without baskets

Fig. 2

- A Lower spray arm
- B Salt container
- C Water hardness selector
- D Detergent dispenser
- E Rinse aid container
- F Filters
- G Rating plate
(with E & F numbers)

Rear

Fig. 3

- a) Water inlet hose
- b) Drain hose
- c) Electrical lead

Programme selector buttons (fig. 1/I)



Off



Rinse and hold



Intensive programme 65°C



Normal programme 65°C

Guide to machine



Normal programme 50°C



Economy/quick wash programme 50°C

Programme sequence indicator (fig. 1/III)



Pre-wash



Wash



Intermediate rinsing



Final rinse



Hot air drying

Guide to machine

Crockery baskets

The baskets are protected with polystyrene during transportation. Remove all polystyrene parts before using the machine.

General advice on dishwashing

● **Economical dishwashing:**

- Collect the dirty dishes and stack them in your dishwasher. Only select a full wash programme when both baskets are full. A rinse and hold programme can be selected during the day to prevent food soil from drying on before a full load has been collected. Always select the programme according to the degree of soiling (see chart on pages 14/15).
- "On glaze" decorations may fade if washed frequently in the dishwasher over a long period of time. Check earthenware for "dishwasher proof" descriptions.
- Aluminium articles have a tendency to discolour when machine washed.
- Some glassware may not be suitable for machine washing. Etching could occur leaving the glasses dull and opaque in appearance.
- Clean food residues on silver dishes and silver cutlery if you do not run a wash programme after the meal (some food such as egg white, egg yolk, mustard, etc., cause stains and discolouration).



● **Unsuitable articles:**

- Wooden chopping boards, heat sensitive plastic articles, pewter, crockery repaired with glue, cracked china, old cutlery, steel knives sensitive to rust, cutlery with wood, bone, china and mother-of-pearl handles.
 - If in doubt about an article check with the manufacturer of the article where possible. Failing this, wash valuable items by hand.
 - When buying new china look out for dishwasher suitable crockery, cutlery and glasses. Buy articles which have straight and smooth sides, large openings avoiding deep indentations on the base of the crockery.
-

Setting the water hardness – adding dishwasher salt

Your dishwasher is equipped with a water softener which transforms the “hard” water into “soft” water required for washing. To regenerate the water softener the salt container in the bottom of the wash tub (fig. 2/B) must contain dishwasher salt at all times. At the end of each programme the water softener is automatically re-generated using some of the salt from the salt container.

For economical reasons and to protect the environment do not use more salt than necessary. Set the water hardness selector (fig. 2/C and fig. 4) to the correct setting using a coin. Your local Water Authority will quote the water hardness in English or Clarke Degrees or parts per million (ppm).

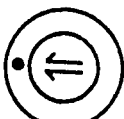
Water hardness			Setting of the water hardness selector
Water hardness area	English or Clarke Deg.	PPM	
IV	27-49	391-712	 *)
III	18-26	267-373	
II	10-17	142-249	
I	Below 10	Below 142	Any setting, no salt required

*) Factory set

Setting the water hardness – adding dishwasher salt

The salt you require is special salt suitable for domestic dishwashers. On no account should table salt, cooking salt, road salt or processed sea salt be used, because they contain substances adversely affecting the water softener.

Important! Detergents and salt are very often available in very similar looking packaging. Take care that you DO NOT fill the salt container with detergent, IT RENDERS THE WATER SOFTENER INEFFECTIVE. The salt container filler neck is situated on the right hand side on the bottom of the wash tub (fig. 2/B). To fill the container – open the door, lift out the lower basket, unscrew the cap marked  and place the funnel supplied with the machine over the opening (fig. 5).

Before the first use only, pour 1.5 to 2 litres (3-4 pints) of water into the salt container.

Then add the salt until it is visible at the top of the container (capacity approx. 2 Kg). During

the filling process, some water is displaced. Remove any spilled salt from the filler neck and replace the cap firmly. Replace the lower basket.

Important!

To prevent salt from entering the washing cycle close the cap to the salt container firmly. Cloudy glassware may result from salt getting into the washing water. No salt residues must be left on the bottom of the tub. To ensure that all salt residues are removed, select a rinse and hold programme or, a complete wash programme if you have enough dirty crockery, after the salt container has been filled.

To replenish the salt container

Replenish the salt container when the “red” marker touches the underside of the screw cap of the salt container (fig. 6).

Filling the rinse aid container

Rinse aid is dispensed automatically during the final hot rinse. It prevents water drops from clinging to the crockery and gives the final sparkle to the china and glassware.

Important!

Use only rinse aids suitable for domestic dishwashers – we recommend Finish.

Never use normal washing up liquids. These have high sudsing properties and are unsuitable for dishwashers. You will find the rinse aid container on the inside of the door (fig. 2/E). Open the container by turning the lid a quarter turn to the left (fig. 7/arrow) and slowly pour rinse aid into the filler neck up to the dotted line. The container will take approx. 150 cc, which will last for approx. 50 programmes. Wipe off any spilled rinse aid to prevent excess foaming during the next wash cycle.

Rinse aid refill indicator

Replenish the rinse aid container when the level indicator window (fig. 8) shows a dark dot surrounded by a lighter circle (⊙). When the container is full the window is darker in colour.

Adjusting the rinse aid dosage

The adjuster to alter the quantity of rinse aid being dispensed is located in the filler neck (fig. 9). The quantity can be varied from 1-6 cc and the corresponding numbers are shown on the adjuster.

To alter the setting, move the arrow to another setting using a screwdriver or coin.

The machine is set to dispense 3 cc rinse aid (arrow is set to "3") automatically during the final rinse. Do not alter the setting unless it becomes necessary (see page 16 "If you think your machine is not working properly...").

Add dishwasher detergent before every wash programme

Before you start a wash programme (except rinse and hold programme) fill detergent dispenser with detergent (fig. 2/D). If the dispenser is closed, push the locking catch (fig. 10/a) and the lid springs open. The amount of detergent to use depends on the degree of soiling of the utensils to be washed. For light soiling you will require approx. 25 g, for normal to heavy soiling approx. 30 g. To help you use the correct amount of detergent the dispenser is marked "Min" (approx. 20 g) and "Max" (approx. 30 g) (fig. 11). Close the lid of the dispenser and press until it snaps shut. The detergent is automatically dispensed at the correct stage of the programme.

We would recommend filling the compartment in the lid (fig. 10/b) level to the top with detergent (approx. 5 g) for all programmes which include a pre-wash.

As effectiveness of detergents differs from one make to another, follow also the recommendations of the detergent manufacturers.

Useful hints:

The "Min" and "Max" markings in the detergent dispenser apply to full loads which is the most economical way of machine washing.

If you want to wash smaller loads, 15 g of detergent is sufficient to obtain an excellent wash result.

Important!

- **Only use detergents for domestic dishwashers.** Never use washing up liquids (they cause excessive foaming and the dishes are not cleaned).
- Always close the detergent pack and store in a dry place (lumpy detergent has lost its cleaning power).
- Always use the recommended amount of detergent.

If you use too much, starch deposits will remain on the dishes which can only be rubbed off by hand.

Loading the machine

Before you load the machine remove any remaining food and bones from the plates and soak saucepans with burnt on food as you would when washing up by hand. The easiest way to load a basket is from back to front.

Lower basket (fig. 12):

Large heavily soiled dishes are best cleaned in the lower basket. **Pull out** the lower basket **as far as the stops** and stack it with large items: plates, serving dishes, serving plates and saucepans as illustrated.

Cutlery basket:

Arrange the cutlery as follows:

- Distribute the unsorted cutlery loosely in all basket compartments so that each item is reached by the wash water.
- Knife, fork and spoon handles down for best results.
- Make sure spoons and forks do not stick together. Use the special holder for tea and coffee spoons.
- Lay long handled utensils such as a soup ladle flat in the top basket to avoid blocking the upper spray arm.

Top basket (fig. 13):

Smaller, more fragile items are washed gently in the top basket. Pull out the top basket as far as the stop to arrange the smaller items such as saucers, cups and glasses as illustrated. You can also use the fold down racks to load extra cups.

Important!

By arranging the dishes correctly you will ensure a satisfactory wash result.

- Stack cups, glasses, saucepans, etc., upside down so that the water can run off freely.
- Thick and curved plates and similar items should be placed in the **bottom basket on the left** where the racks are wider so that each item is reached by the wash water.
- Bowls, saucepans and frying pans are well positioned upside down over the short racks in the lower basket.
- Load glasses so that they **do not touch each other** (to prevent stains and break-ages).
- When stacking items under the folding racks in the upper basket make sure that the water sprays can reach both layers.

Switching on

(programme chart – see next page)

1. Fully open the water tap.
Important: If the dishwasher was started but the water tap had not been opened, switch off the machine, fully open the water tap, switch on the machine and start the programme again.
2. Turn the start/indicator switch (fig. 1/III) clockwise to symbol **A** or **B**.
3. Press on/off and programme selector buttons (fig. 1/I) to start the programme.

Programme sequence indicator (fig. 1/III)

After the machine has been started the programme indicator passes through the various stages automatically, indicating each stage reached as it turns.

The indicator **stops temporarily during the wash and the final rinse** until the water has reached the required temperature.

Programme correction

If you have selected the wrong programme by mistake, simply press the programme selector button or turn the start/indicator switch to the correct setting.











Warning! Before turning the start/indicator switch, switch off the machine to prevent detergent being released into the machine by mistake.

Switching off – unloading the machine

The dishwasher switches itself off automatically when the programme is finished.

- Press the on/off button. The machine “on” light goes out.
- Turn off the water supply.
- Then open the door (steam will escape from the tub!) and leave it slightly ajar. Wait approx. 15 minutes before unloading the machine. If the dishwasher is built-under a continuous work surface, please observe the instructions concerning the protection of the worktop on page 19.
- Empty the lower basket first and then the upper basket. This prevents any water which may have collected in recessed or curved items in the upper basket from dripping onto crockery in the lower basket.
- Check the filters after every programme. If they are dirty clean them as per instructions on page 16.

Programme chart

Programmes	Suitable for:	Setting the programme: Turn start/ indicator switch to symbol:	Turn programme selector to:
Rinse and hold	Rinsing heavily soiled items which are not washed immediately	A	 
Intensive 65°C	Heavily soiled china and saucepans with dried on food deposits, particularly protein and starch	A	 
Normal 65°C	Normally to heavily soiled china and saucepans with dried on food deposits (particularly vegetables such as spinach, carrots, starch, etc.)	A	 
Normal 50°C	Normally soiled crockery and temperature sensitive items (e.g., glasses, plastic ware)	A	 
Quick wash 50°C Full load Half load	Normally to lightly soiled crockery and glasses	B	 

Programme chart

Programme Sequence	Programme duration in minutes on cold water supply	Energy consumption (kWh) on cold water supply	Water consumption in litres
Pre-rinse	11	0.1	6
Pre-wash, wash, 2 intermediate rinses, final rinse, drying	83	1.7	25
Pre-wash, wash, 2 intermediate rinses, final rinse, drying	80	1.6	20
Pre-wash, wash, 2 intermediate rinses, final rinse, drying	66	1.0	20
Wash, 2 intermediate rinses, final rinse, drying	55 40-45	0.9 0.7	15 15

Cleaning the filters

Coarse filter (fig. 15)

Remove the coarse filter and brush it clean under running water. Check the lower half of this filter also and remove the food residues which may be trapped there. Note that the upper cylindrical section of the coarse filter can be lifted out (fig. 16).

When replacing ensure that the upper section sits straight and tight before re-inserting the coarse filter.

Fine filter (fig. 17)

Clean the fine filter and microfilter as and when necessary. To remove the fine filter turn it anticlockwise. Clean it thoroughly. When replacing the fine filter make sure that the edge of the filter forms a proper seal with the bottom of the tub. Then turn it clockwise.

Never carry out a wash programme without a filter.

Maintenance

Fascia panels and controls must not be cleaned with abrasive cleaning materials or furniture polish. Should cleaning be necessary use lukewarm water.

If you think your machine is not working properly

Before you call out a service engineer check the following points carefully, it will save you the cost of the engineer calling on you.

The programme does not start?

- Are the fuses in working order?
- Is the door closed properly?
(There is a short pause after the machine has filled with water!)

The machine is not taking in any water?

- Have you turned on the tap?
- Check the water inlet hose (it must not be kinked).

The start/indicator switch stops at the beginning of the wash (▣▣▣▣) or final rinse (☼) cycle?

- Have you opened the water tap fully?
(See page 13.)
- Is the filter in the inlet hose blocked? The filter is located where the hose attaches to the tap. Unscrew the hose and clean the filter under running water.
- Check the water pressure. It must be at least 1 bar (15 lb/sq. inch) – see page 19.

The dishes are not clean?

- Did you select the correct programme?
The programme has to be chosen according to the degree of soiling.
- Did you stack the dishes according to our recommendations? The water sprays must have access to the dishes from all sides – the baskets must not be overloaded.
- Were the spray arms able to rotate freely? When the upper spray arm is stationary it rests at an angle to allow the remaining water to drain off at the end of a programme. During the programme it will automatically return to a horizontal position.
- Are the filters clean? Have you inserted the filters properly after cleaning?
- Did you use the correct amount of detergent?
- Check that the drain hose has been installed according to our instructions on page 20/21.

If you think your machine is not working properly

- If the machine is connected to a hot fill supply – only economical if hot water is available “nearly free of charge” – do not use 50°C programmes to allow detergent sufficient time to work.
- Did you top up the salt container? If the water hardness in your area is over 10 degrees and your dishwasher is operated without salt, the result may be affected adversely and white and yellow chalk deposits will remain on your dishes.
- Did you select the correct degree of water hardness according to the information of your local Water Authority? (See also page 9.)

The dishes are not dry and sparkling?

- Did you use a rinse aid recommended by us?
- Did you fill up the rinse aid container? Please check the rinse aid level indicator on the inside of the door.
- Is the correct quantity of rinse aid being dispensed?

Overdosing of rinse aid:

If too much rinse aid is used opaque or bluish smears will appear. **Reduce the output.**

Underdosing of rinse aid:

If too little rinse aid is used white/grey dried-on water marks will appear. **Increase the output.**

There are rust spots in the machine?

- The stainless steel tub, the inner door and the filters cannot rust. If you find rust spots, these are introduced with the water or due to rust on cutlery, saucepans, etc. Did you select a rinse and hold programme or a complete wash programme after filling the salt container? Remove such stains with a stainless steel cleaner.

The drain pump is working continuously?

- The anti-flood system has been activated (see page 21).
- **First** close the water tap, then switch off at the power socket and remove the plug.
- To rectify the problem, call AEG Service.

Service

Use our check list on pages 16/17 to make sure you cannot rectify the fault yourself.

- **If you call out a service engineer in connection with one of the problems listed the cost involved will have to be passed on to you even during the warranty period. The same applies to wrong usage or misuse of the machine.**
- Therefore, follow the instructions in this booklet and any other of our recommendations closely.
- Should you be unable to locate the cause of the problem in spite of the check-list please contact your AEG Service Department and do not carry out any repairs particularly electrical ones yourself.
- Our appliances comply with the relevant safety regulations. Repair of electrical appliances must only be carried out by specialists. Repairs carried out by any other personnel present considerable safety hazards to the user.

When calling for a service engineer please quote the model number and the serial number of your machine.

These numbers are printed on the rating plate (fig. 2/G).

Fill in these numbers for your future reference

E-No. (E-No.)

and the

Serial-No. (F-No.)

These numbers enable our Service Department to **prepare** spare parts to repair the machine on first call wherever possible to save you money.

Information for the installer

Installation

The appliance must stand level and on a firm floor. The floor should be clean and free from floor polish and grease. The appliance has adjustable feet. If necessary adjust feet.

Should a freestanding machine be built under a worktop in a built-in kitchen, the table top of the machine can be removed. In this case you need to protect the underside of your kitchen furniture worktop at the front with an aluminium foil strip which is available as an optional extra from AEG Spare Parts Department. You will find details of how to secure the aluminium foil strip on the back of the strip. This is the only way your worktop will be protected against steam being emitted when the dishwasher door is opened.

To comply with Safety Regulations, the machine must be installed in such a way that there is no access to live parts or internal connections with functional insulation.

Please note

(this applies to free-standing appliances with worktop only)

Should a dishwasher be installed next to a gas, solid fuel or electric cooker due to lack of space, a heat insulating panel (85 x 57.5 cm) has to be fitted, the side facing the cooker has to be lined with aluminium foil.

If you have a build-under machine (U-version) see also enclosed installation instructions for further details.

Water supply

To protect the drinking water supply system your dishwasher is fitted with an anti-syphon. A connection to a hot water supply up to a maximum of 70°C with a minimum pressure of 1 bar is possible, **although the machine must not be connected to single outlet instantaneous electric or gas heaters.**

Please ensure you comply with the drinking water regulations of your local Water Board.

The high pressure hose with 3/4" hose coupling complete with sealing washers is supplied. We recommend not to use other washers which may be of inferior quality. It is sufficient to tighten the nuts by hand.

The machine may be connected:

- a) directly to a tap with 3/4" BSP thread termination
- b) to a T-junction on your existing tap, or preferably
- c) to a completely separate water supply in order to avoid interference with the kitchen water supply during operation of the machine.

Minimum water pressure: approx. 1 bar pressure above atmospheric pressure (1 atu = approx. 1 kp/cm² = approx. 10 N/cm²). For less than one bar of pressure above atmospheric pressure, consult the AEG Technical Department. Maximum permissible water pressure: approx. 10 bars. For over 10 bars excess pressure, connect a pressure relief valve (obtainable through your installer).

If a longer water supply hose is needed it should be a single run of high pressure hose available in two lengths (3.50 m E-No. 645 430 552 and 5 m E-No. 645 430 553) from AEG Spare Parts Department. Never add extensions to hoses. Turn off the water tap if the machine is not in use.

Information for the installer

Water discharge

At the rear of the machine the drain hose is secured with plastic straps which must be removed. Route the drain hose along the recess provided at the rear of the dishwasher (fig. 3/b). The outlet end of the hose is 19 mm diameter and should fit any available sink trap connections and is secured by means of the hose clip supplied.

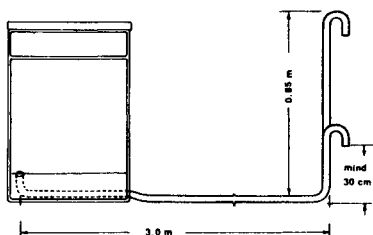

Should you wish to hook the drain hose onto a sink use the **plastic hose holder supplied** with the machine. See illustration on this page. The holder has a hole to enable you to secure the holder to the wall if the sink edge is too wide. In this case thread a piece of string through the hole and secure to the tap or wall above the sink.

Your dishwasher is fitted with a water pump, controlled by the programme to pump off the water up to a height of 1 m. Should it become necessary to extend the drain hose, use only original extension hoses. These are available in lengths of 2.70 m and 4.0 m under E-No. 646 060 763 and E-No. 646 060 764 as spares from your AEG Spare Parts Department. The pump is capable of pumping water to a distance of 3 m horizontally, at a height of max. 85 cm above floor level. The minimum height above the base of the machine must always be 30 cm.

The internal diameter of the extension hoses must be 19 mm to allow the machine to function correctly.

The recess at the back of the machine offers sufficient space to accommodate the drain hose for installation to the left or right of the machine.

Important

When connecting the drain hose make sure that it lies freely in the recess at the back of the machine and is neither kinked nor twisted. The drain hose can be hooked into a separate stand pipe.

When connecting the drain hose to a sink trap the internal diameter of the connection must be 15 mm minimum.

The drain hose must be at least 30 cm above the base of the machine before it is connected to any drainage system.

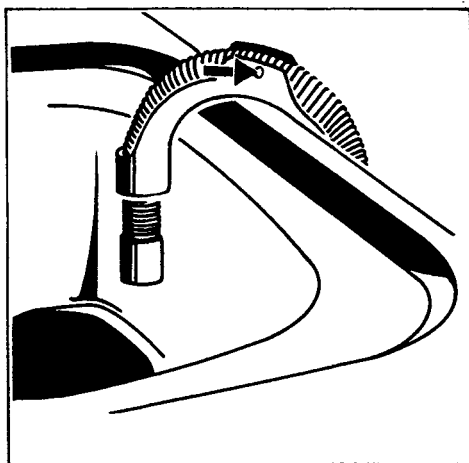

Information for the installer

Anti-flood system

The dishwasher is equipped with anti-flood devices.

The machine has an overflow protection which prevents excess water from entering the machine and a leakage protection underneath the machine (a float in the base of the machine). The float is activated by leakage from the appliance. In both cases the water supply to the machine is shut off and the drain pump is switched on.

Flooding from the machine through leakage or overflowing has thus been eliminated. Any remaining water in the machine is automatically pumped away.

The fault can be recognised by the continuous operation of the pump. In this case **first** turn off the water tap, then switch off at the power socket and remove the plug.

Electrical connection

WARNING! This appliance must be earthed.

Please note: The plug moulded onto the cord incorporates a fuse. For replacement, use a 13 amp BS 1362 fuse. Only ASTA approved or certified fuses should be used. The fuse cover/carrier must be replaced in the event of changing the fuse. The plug must not be used if the fuse cover/carrier is lost. A replacement cover/carrier must be obtained from an authorised electrical goods retailer. If the socket outlets in your home are not suitable for the plug fitted to the appliance, then the plug must be cut off and an appropriate one fitted. When fitting the plug please note the following points:

IMPORTANT

The wires in the mains lead are coloured in accordance with the following code:

GREEN and YELLOW – EARTH
BLUE – NEUTRAL
BROWN – LIVE

As the colours of the wires in the mains lead of this appliance may not correspond with the coloured markings identifying the terminals in your plug proceed as follows:

1. The wire which is coloured GREEN and YELLOW must be connected to the EARTH terminal in your plug, which is marked with the letter E or by the earth symbol  or coloured GREEN or GREEN and YELLOW .
2. The wire which is coloured BROWN must be connected to the LIVE terminal which is marked with the letter L or coloured RED.
3. The wire which is coloured BLUE must be connected to the NEUTRAL terminal which is marked with the letter N or coloured BLACK.

When wiring the plug, ensure that all strands of wire are securely retained in each terminal. Do not forget to tighten the mains lead clamp on the plug.

Clamping clips and metal pins

You will find 2 clamping clips and 2 metal pins in the accessories package supplied with your machine. If you fit a decor panel to your machine to match the adjacent kitchen furniture, these clips and pins are used to securely lock the decor panel into the frame.

When the decor panel is fitted, insert each of the clamping pins into the recess between the decor frame and the control panel frame. Insert metal pin into the clip and break off protruding surplus pin end (see illustration).

If you intend to change the decor panel remove the clips by tapping the pins from the side with a screwdriver taking care not to damage the decor frame.

When fitting a new decor panel new clips and pins are required. These are available from AEG Spare Parts Department.

Clamping pin ET No. 646 054 470

Metal pin ET No. 646 056 660

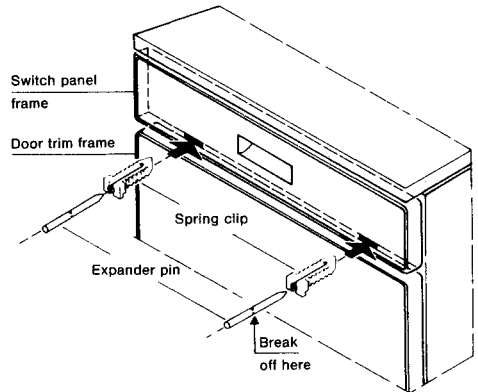

Technical data

Capacity according to IEC publ. 436:

12 place settings including serving dishes.

Water pressure 1 to 10 bar.

The dishwasher complies with the radio interference requirements of the EEC Directives 82/499/EEC and the standard EN 60 555 part 1-3/DIN VDE 0838 part 1-3. June 1987.

The consumption values quoted in the product information refer to the normal 65°C programme.

Detergent: 5 g for pre-wash
25 g for main wash

Decor panel dimensions

Freestanding appliances H 590 x 580 mm

Panel thickness in frame: maximum 4 mm

Loading example for 12 place settings including serving dishes according to IEC Publ. 436

12 place settings:

12 soup dishes, dia. approx. 24 cm
12 dinner plates, dia. approx. 24 cm
12 dessert plates, dia. approx. 19 cm
12 tea cups, dia. approx. 9 cm
12 saucers, dia. approx. 14.5 cm
12 tumblers, dia. approx. 7 cm
 approx. ¼ litres size
12 knives
12 forks
12 spoons
12 teaspoons
12 dessert spoons

Serving setting:

1 oval platter, approx. 37.5 x 26 cm
1 round bowl, dia. approx. 21.5 cm,
 height approx. 10 cm
1 round bowl, dia. approx. 17 cm,
 height approx. 7.8 cm
1 fruit dish, dia. approx. 15 cm
1 serving fork
2 serving spoons
1 gravy spoon

AEG Hausgeräte AG
Postfach 1036
D-8500 Nürnberg 1

© Copyright by AEG

H 246 250 440 - 06880.5/02 -

AEG Domestic Appliances Ltd

Customer Care Department
55-77 High Street
Slough
Berkshire SL1 1DZ

Telephone: 08705 350350