

---

# **AEG Dishwasher FAVORIT 145 S**

---

Operating Instructions

**AEG**

Your  
**FAVORIT 145 S**  
Dishwasher

offers you the best possible dishwashing results and economy.

The special characteristics of this machine are an economy programme for normal soiled crockery and a light economy programme for lightly dirty dishes, coffee/tea cups, saucers, delicate glass wares etc., with low operating costs and a very good cleaning result.

Please read the following instructions very carefully before using your dishwasher in order that you may achieve the greatest benefit from the many possible functions featured only in this appliance.

## Contents

	Page
Installation	5
Electrical connection	5
Water supply	5
Water outlet	6
Opening and closing the door	7
Preparing the dishes	7
Arranging the dishes	8
Detergent and rinse aid	9
Controls	11
Programmes	12
Operating procedure	13
Water softener	13
Useful hints	14
Maintenance	15
What to do if . . .	15

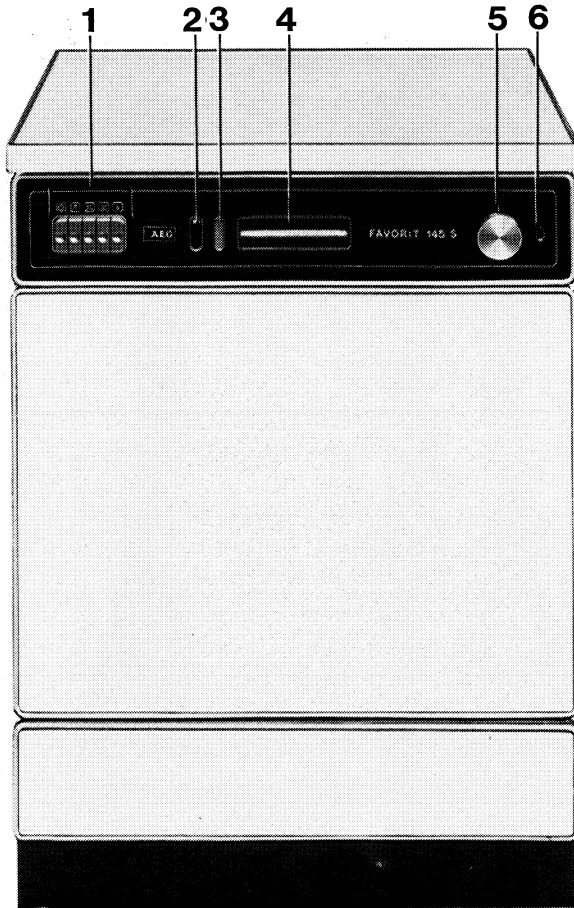

- 1 = On/off button/Programme selection buttons
- 2 = Sliding switch for correct degree of water hardness
- 3 = Rinse aid level indicator and on/off indicator light
- 4 = Handle for opening the door
- 5 = Programme sequence indicator
- 6 = Salt level indicator

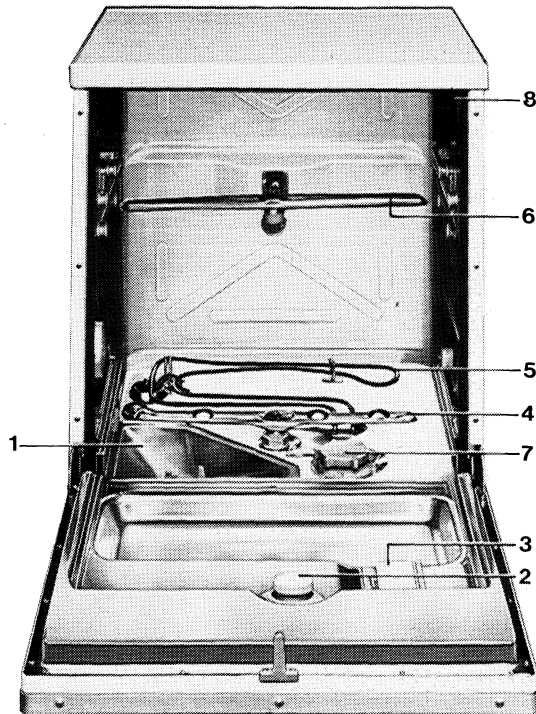

- 1 = Coarse and fine filter in tub
- 2 = Storage unit for rinse aid
- 3 = Detergent dispenser
- 4 = Lower spray arm
- 5 = Heating element
- 6 = Upper spray arm
- 7 = Salt storage container
- 8 = E-number and serial-number

## Installation

Before you use your new FAVORIT dishwasher, you should make the following checks.

### Removal of packing

During transit the outlet hose is attached to the machine at the back with plastic tape which must be removed. When returning the machine to its original position, make sure that the outlet hose lies freely in the recess at the back of the appliance and is neither kinked nor crushed on the floor. The lower basket is secured by transport clips inside the tub.

Open the door and remove the clips as well as the corrugated cardboard packing.

### Dimensions:

with worktop	Height	85 cm
	Width	60 cm
	Depth	60 cm

without worktop	Height	82 cm
	Width	59.5 cm
	Depth	57.5 cm

The appliance **must** stand level – if in doubt use a spirit level – and, if necessary adjust front feet. To do this, loosen feet by a quick turn to the left. Then remove clips with a screw driver.

### Weight:

Approx. 65 Kg net

The appliance has adjustable feet at the front and fixed rollers at the rear.

### Permanent fitting in kitchens:

Seek advice from your Specialist Retailer from whom you purchased the appliance.

### Dimensions of decor panel

(for built-under model)

Door	457.5 x 589.5 mm – radius 11
Lower panel	120.5 x 589.5 mm – radius 11

## Electrical connection

Voltage: 220 V AC only (UK versions 240 V)  
Connected load 3.03 kW which may be changed over to 2.08 kW.

Fuse protection for 3.03 kW = 16 A, for 2.08 kW = 10 A (UK version please fit a 13 amp fused or 15 amp plug).

**WARNING:** This appliance must be earthed.

### Important

The wires in the mains lead are coloured in accordance with the following code:

1. green and yellow = earth
2. blue = neutral
3. brown = live

Fit the mains lead with a 3 pin 13 or 15 amp plug.

As the colours of the wires in the mains lead of the appliance may not correspond with the coloured marking identifying the terminals in your plug, please proceed as follows:

1. The wire which is coloured green and yellow must be connected to the earth terminal in your plug, which is marked with the letter “E” or by the earth symbol or coloured green, yellow, or green and yellow.
2. The wire which is coloured brown must be connected to the live terminal which is marked with the letter “L” or coloured red.
3. The wire which is coloured blue must be connected to the neutral terminal which is marked with the letter “N” or coloured black.

When wiring the plug ensure that all strands of wire are securely retained in each terminal. Do not forget to tighten the mains lead clamp on the plug. If your installation is fitted with 2 pin socket outlets, or if you are in doubt, please consult a qualified electrician.

## Water supply

The high pressure hose ( $\frac{3}{8}$ " = 10 NW, 1.55 m long) with  $\frac{3}{4}$ " hose coupling complete with sealing washers is supplied. We recommend not to use other washers which may be of inferior quality. It is sufficient to tighten the nuts by hand but if a spanner is used proceed very carefully.

The machine may be connected

- a) directly to a tap with  $\frac{3}{4}$ " B.S.P. thread termination
- b) to a T junction on your existing tap or preferably
- c) to a completely separate water supply in order to avoid the interference with the kitchen water supply during operation of the machine.

A connection to a hot water supply up to a maximum of 60 °C is possible, although the machine must not be connected to single outlet instantaneous electric or gas heaters.

Minimum water pressure: approx. 1 bar pressure above atmospheric pressure (1 atu = approx. 1 Kp 3 cm<sup>2</sup> = approx. 10 N/cm<sup>2</sup>)

For less than one bar of pressure above atmospheric pressure, consult the servicing engineer. Maximum permissible water pressure: approx. 10 bars. For over 10 bars excess pressure, connect a pressure relief valve in series (Type AD 723, E-No. 612.896.723).

If a longer water supply hose is needed it should be a simple run of high pressure bursting strength of 60 bars. **Do not add extensions to hoses.** Under no circumstances should cheap garden hoses or similar types be used. Please also ensure that hoses are connected by means of screw connections with suitable hose clips.

**Turn off the water tap if the machine is not in use.**

It is not unusual to find a small amount of water in your new dishwasher which remains from our thorough factory checks.

## Water outlet

Your dishwasher is fitted with a water pump, controlled by the programme to pump off the water up to a height of 1 m. The minimum height should always be 30 cm above floor level. **(The maximum extension, when installed horizontally, is 3 m at a height of 85 cm above floor level.)**

The outlet hose (internal diameter 15 mm) has a bend for hanging over the edge of the sink. If the sink edge is too wide, fit the hose

support provided as illustrated or fasten the support to the water tap. Make sure that the outlet hose is installed along the left hand side in the base of the machine.

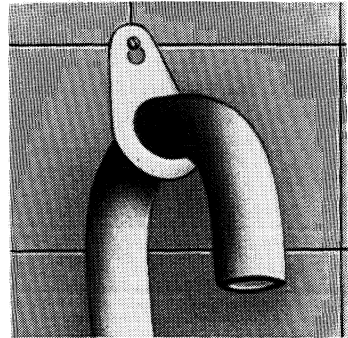

The recess at the back of the machine offers sufficient space to accommodate the outlet hose for installation to the left or right of the machine (see illustration).

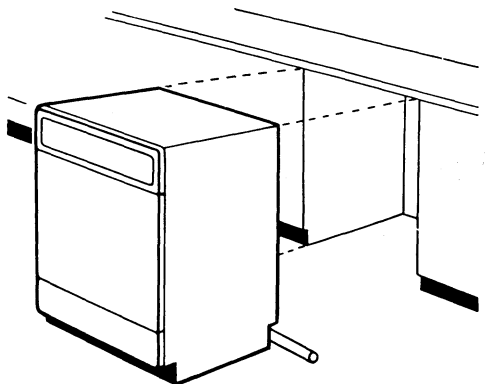
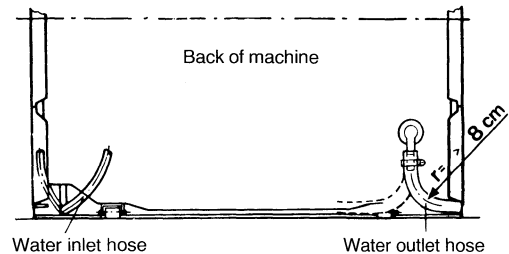

Should it become necessary to extend the drainage hose, a hose with an internal diameter of 19 mm has to be used for the distance between A (plastic bend) and C. This extension hose is available as a spare part.

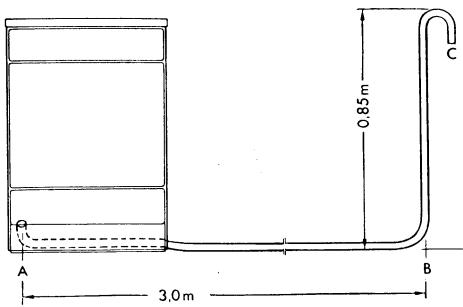

## Adding salt

See Section “Water Softener”

## Preparing the dishes

Remove all hard and insoluble items, e. g. meat bones, fish bones etc., large pieces of left over food – potato, spinach, porridge, coffee, and tea leaves, lettuce leaves and fruit peelings, before arranging the dishes.

Treat saucepans and other dishes just as you would for washing by hand, soften stubborn remains of food with water, if necessary use a little detergent.

The maximum length from A to B must not exceed the total of approx. 3 m, whereby the internal diameter must not be reduced by hose bends etc.

The crooked end of the drainage hose must be hooked on or attached otherwise at a minimum height of approx. 30 cm above floor level.

## Opening and closing the door

The door is easy to open, grip the handle on the control panel and pull the door in a downward direction. The door also serves as a surface on which the lower basket can be rested.

Before closing the door, push back both the upper and lower basket completely.

When closing the door, press firmly shut until the lock engages.

If possible, avoid opening the door during operation as this may effect the wash result adversely.

If you wish to add items after the programme has started, press the “off” push button, wait approximately 3 seconds until the spray arms have stopped, open the door. Add the items. Close the door and press appropriate programme button.

If the machine has already heated the water for a 65 °C wash, wait 30 seconds before you re-start the machine.

## Arranging the dishes

Pull the lower basket out of the machine as far as the stops. This can then be stacked with dishes while resting on the door. It is designed for large articles: plates, serving dishes and serving plates and saucepans.

Place large plates and soup dishes to the left and the right at the rear of the rack with the soiled side facing towards the centre. Place side plates to the right and left of the cutlery basket. Items of up to 30 cm in diameter may be placed in the lower basket.

The cutlery basket is divided into two parts. One part is fixed at the rear between the plate supports. The other section is located in the front and is fixed by means of clips on the underside to the crosspiece for the lower basket. This allows it to be shifted further to the left or to the right according to the size of the plates.

Distribute cutlery so that it is not fanned out. Knives and spoons are placed with their handles pointing downwards. Do not place spoons too closely together. If necessary, place long handled utensils in the upper basket.

Both cutlery baskets are equipped with special holders at the front and back for small coffee/tea spoons.

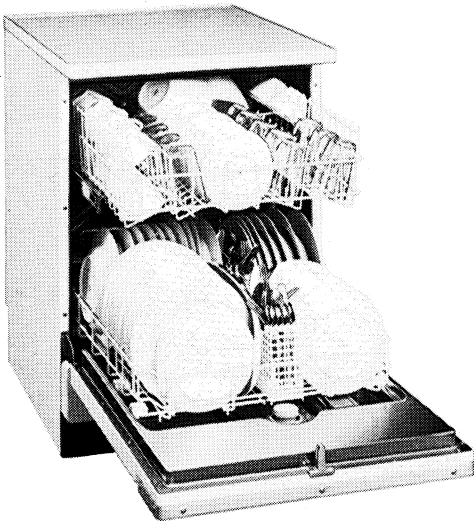





Pull out the upper basket as far as possible (up to the stops) to stack saucers, dishes, glasses, coffee and tea pots and other small items. Stack cups, bowls, in such a way that the water will run off freely. (Use sloping surfaces provided in the upper basket). Items of up to 19 cm in diameter may be placed in the upper basket.

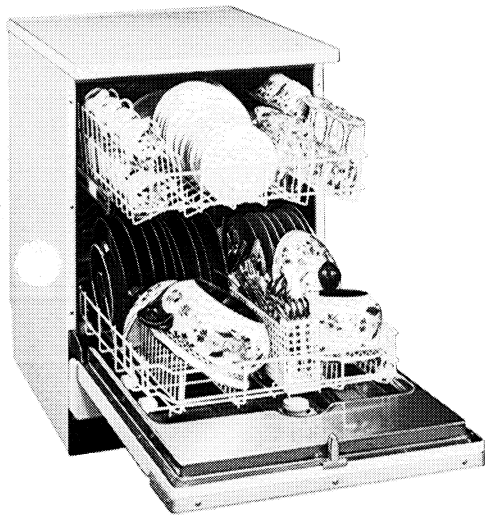

The photographs show various methods for loading the racks.

After stacking and inserting the baskets, check that the spray arms can revolve freely.

After a few washes, you will no doubt have found the best possible arrangement for your dishes.

The photographs at the end of this book show you how to accommodate 14 international place settings, including one serving setting.

## Detergent and rinse agent

Use reputable brand name detergents for a satisfactory wash result.

We recommend Sun and Sun rinse aid. Washing up liquids, even with similar names, should not be used.

### Detergent

Before filling the dispenser check that it is both clean and dry. The detergent should be placed in the dispenser immediately before use. It must not be stored in the dispenser. Should it be necessary to open the dispenser lid manually, push the catch to the left. Do not forget to close the lid once the detergent has been added. The detergent will be added to the water automatically during the wash cycle.

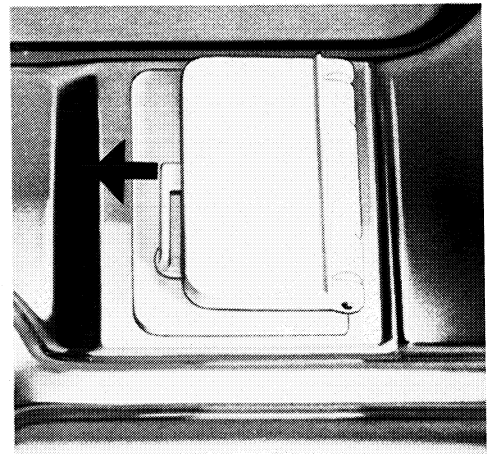

Detergent Dispenser

## Rinse aid

The rinse aid (liquid) is released during the last hot rinse. It aids the drying of the load by breaking down the water tension allowing it to flow from the items in a sheet rather than droplets, leaving the plates sparkling. An automatic rinse aid storage unit is fitted in the door. If you wish to try out various rinse aids, do not fill the unit completely the first time. The capacity of the storage unit is about 150 ccm.

To fill up, unscrew the filler cap. Fill the rinse aid container (red centre) to the grey marking. Replace the filler cap. Try not to spill any rinse aid as this may effect the next wash adversely due to excessive foaming.

If, by any chance, rinse aid is spilled into the funnel between inner and outer pipe, the ventilation of the storage container may get blocked and no further rinse aid can be added. In such a case, re-tighten filler cap and close door briefly. Then continue with the filling.

You will find the rinse aid level indicator on the control panel. Refill the rinse aid container when the level has reached the lower edge of the indicator.

## Rinse aid adjuster

Depending on local water characteristics, you may need to adjust the rinse aid output.

The adjuster is located in the centre of the filler nozzle.

It is factory set at 3 cu. cm. If the adjuster is **turned to the left, more** rinse aid is dispensed and if **turned to the right, the** rinse aid output **is reduced**. Various markings around the edge of the adjuster indicate the increase or decrease of the rinse aid output.

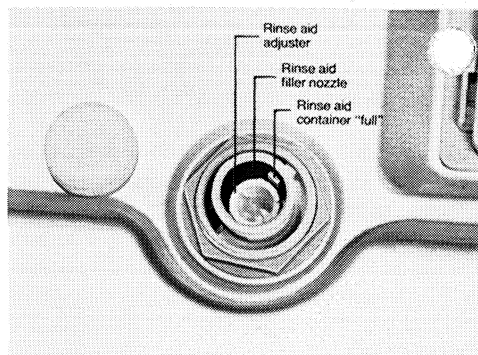

Detergents	Rinse aids	Manufacturer/Distributor
Finish	Finish rinse aid	Soilax (UK) Ltd., Slough
Sun	Sun rinse aid	Lever Bros. Ltd., Port Sunlight, Cheshire

## Controls

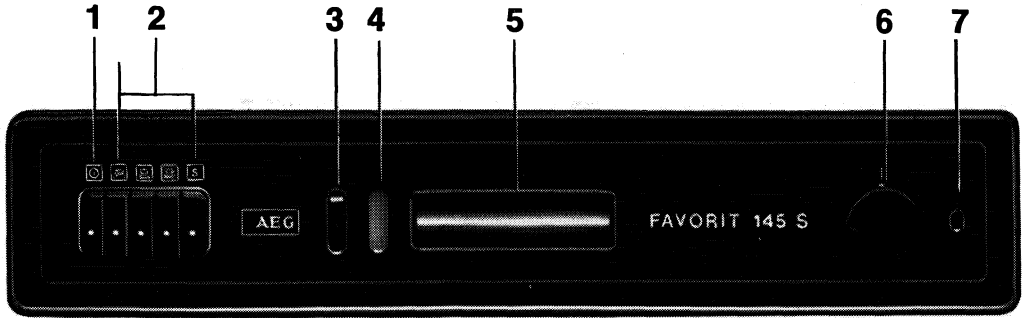

- 1 = On/off button
- 2 = Programme selection buttons
- 3 = Sliding switch for water hardness
- 4 = Rinse aid level indicator

- 5 = Handle for opening the door
- 6 = Programme stage indicator
- 7 = Salt level indicator

### Position of programme stage indicator button

for light programme

for all other programmes

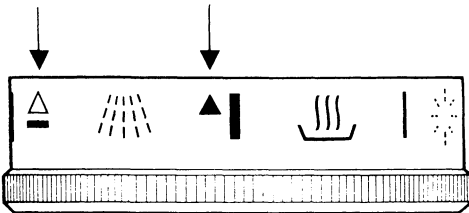

### Push buttons and programme stage indicator button





Selection of the wash programme is by means of push buttons. Prior to selecting a programme the programme indicator button has to be turned to the correct starting position as illustrated above.

Switch on by pressing the on/off button. The rinse aid level indicator lights up. Now select the programme of your choice.

You will find an explanation of the symbols above the push buttons in the following table and in the summary of instructions printed on the inside of the door of the appliance.

### Programme stage indicator button

The symbols on the indicator are as follows:

-  = Wash with detergent
-  = Pre-rinse or intermediate rinse
-  = Final rinse with rinse aid
-  = Hot air drying

The indicator will progress with the programme. It will remain temporarily stationary while the water is being heated for the pre-wash, main wash and final rinse, until the required temperature has been reached.

### Changing programmes

Should you wish to correct a programme which has already started, press the off button and turn the start button in a clockwise direction to the correct starting position.

Detergent and rinse aid will have been fed into the machine.

Refill the detergent dispenser and **wipe off any spilled rinse aid**. You can now re-select.







### Switching off

When the programme is finished, the machine switches off automatically. When you press the "on/off" switch, the light of the rinse aid indicator will go out.

## Programmes

Below you will find the four programmes of your dishwasher, together with their operating sequence and operating instructions. Try out

the programmes to establish which one is most suitable for your household.

Position of start button	Symbol	Programme	Programme sequence	Suitable for	Washing period mins. approx.
		On/off	–	–	
▲		Rinse & hold	Pre-rinse Pre-rinse	When full load is washed at a later time	14
▲		Hot 65°	Pre-rinse Pre-rinse Wash 65° Rinse Rinse Rinse Final rinse 65° Drying	Heavily to normally soiled crockery with dried on food soils particularly vegetable soil like spinach, therefore 2 rinses before the wash	88
▲		Normal 50°	Pre-rinse Pre-rinse Washing 50° Rinse Rinse Rinse Final rinse Drying	Normally soiled crockery including items which can be washed at 50° but not at 65 °C such as plastic items	76
▲		Economy 65°	Pre-rinse Wash 65° Rinse Final rinse 65° Drying	Normally soiled crockery	82
△		Light 50°	Wash 50° Rinse Rinse Final rinse 50° Drying	Slightly dirty dessert dishes and coffee/tea cups and saucers as well as delicate glassware	66

## Operating procedure

If not permanently connected, **hang the outlet hose over the sink and attach the inlet hose to the water tap. Turn on the water tap.**

**Plug the machine into the wall socket or in the case of a permanent connection, switch on.**

**Open the door.**

**Arrange the cutlery and crockery in baskets. Push baskets into machine.**

**Put 2 level tablespoons of cleaning agent in the dispenser.**

**Close door.**

**Check rinse-aid level indicator.**

**Check salt level indicator** for water softener (see page 13).

**Turn programme indicator button to correct starting position according to illustration on page 10.**

**Press the ON/OFF-button.** The rinse aid level indicator lights up. Press programme button and water enters the machine. The programme starts.

The programme indicator button progresses with the programme. It remains stationary during the wash and final rinse until the required temperature has been reached.

**When the programme is finished,** the machine will stop automatically.

**Press the off button.** The light of the rinse aid level indicator light will go out.

**Turn off the water tap.**

**Remove the plug from the wall socket or switch off.**

Do not remove the crockery immediately from the machine – leave it for approx. 15 minutes, with the door left slightly ajar.

**We recommend that you empty the lower basket first and then the upper basket.**

## Water softener

Your dishwasher has been provided with a water softener, which gives you soft, lime free water for the rinses. This greatly aids the cleaning process and prevents chalky patches.

All you need to do is to top up the salt container from time to time.

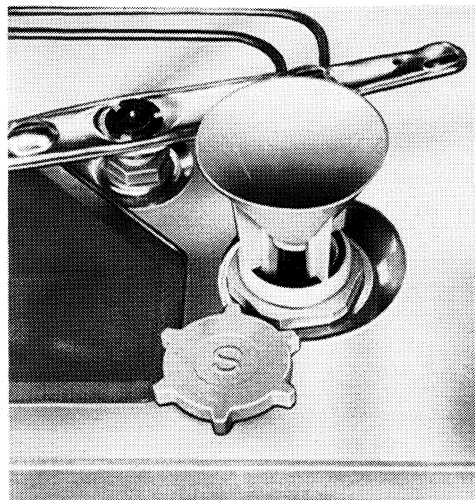

Before using the machine for the first time, lift out the lower basket, unscrew the cap from the salt container and fill it with water. Place the funnel over the opening and pour the salt into the container until it is full to the top. Some water will overflow which will be pumped off at the start of the next programme.

Clean any surplus salt from the thread of the container and replace the cap. Replace the basket.

The machine is ready for use.

Three different colours indicate the varying degrees of water hardness.

**Orange for water hardness up to 16° – colour indicator appears after 64 programmes.**

**Yellow for water hardness between 17° and 26° – colour indicator appears after 32 programmes.**

**Green for water hardness between 27° and 48° – colour indicator appears after 16 programmes.**

Select the right colour according to the water hardness in your area. The local Water Board will supply you with this information.

During production the machine is set for a water hardness of up to 16° (orange).

You can re-set the machine by yourself **(please ensure that the machine is switched off)**, preferably using a ballpoint pen or some other pointed object.

Watch out for the matching colour on the salt level indicator window. When ever the colour in the window matches the one you have selected, salt has to be added. The colour remains for a further programme before disappearing again; please take this into account when using your machine for the first time. Ignore all other colours which appear in the window.

Although not taking any salt, the rinse and hold programme is counted by the indicator device. If this programme is used frequently, this will result in less salt being required when the indicator window shows that the salt container has to be replenished.

Suitable forms of salt are common salt and rock salts which do not contain substances insoluble in water, and special reclaimed salts with a maximum grain size of 5 mm.

**Unsuitable forms of salt are diet salts containing insoluble elements, i. e. cattle salt, road salt, processed sea salt and many household salts containing special additives for free flowing.**

## Useful hints

1. If you use the dishwasher at the end of each day, use the rinse and hold programme after you have stacked the breakfast and lunch dishes to prevent food soil from drying on.
2. Place items of different metals such as silver and stainless steel in different compartments.
3. As with washing by hand, certain types of “on glaze” decorated china and some aluminium items have a tendency to discolour or fade.
4. “Soft” glassware tends to become opaque after being washed many times. It is advisable to ask the manufacturers of any crystal glassware whether it is “dishwasher” suitable. Use the “light” programme at 50° for glassware.  
  
Particular valuable items with long stems or coloured glassware such as MURANO Glass and handicraft glassware should be washed by hand. The decorative markings on glasses tend to come off! Do not put ashtrays and vases into your dishwasher!
5. Wooden and bone handled cutlery is unsuitable for machine washing unless it has been specially treated.
6. Check whether plastic items can withstand a temperature of 65 °C. Do not stack plastic items above the heater, if possible use the upper basket, or if you are in doubt, wash by hand.
7. When buying tableware and dishes ensure that they can be washed in a dishwasher.

## Care and maintenance

On completion of the washing process, turn off the tap and remove the plug from the socket, or switch off. Leave the door open for a short time, in order to let the moisture escape from the tub.

The tub cleans itself automatically.

The circular coarse filter in the base of the tub should be cleaned after each wash.

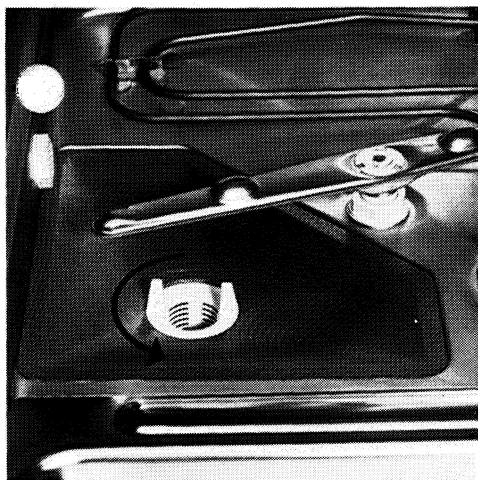

Remove the lower basket and take out the filter by turning it anti-clockwise and lifting it out. When replacing, ensure that it sits straight and is secured properly, by tightening it in a clockwise direction.

### **Never carry out a washing programme without a filter!**

The large fine filter underneath generally cleans itself. However, it must be checked from time to time, if necessary, underneath and inside the cylindrical section as well. If necessary, use a brush for this purpose.

When replacing, make sure that the filter sits straight. Occasionally clean the filter in the water inlet hose.

The heating elements are made of high grade stainless steel. The dark colour has no adverse effect on quality or service life. The tub and inner door are also made of high grade stainless steel. If rust occurs on these sections, this can be attributed to water containing iron. Remove with Jif, do not use any abrasives.

## What to do if . . .

If your dishwasher does not work, this is often due to small things, which you can put right.

### **1. The programme does not start**

Have you plugged the machine in? Have you switched on the main switch?

Are the fuses allright?

Is the door closed properly?

Have you selected the correct programme?

### **2. No water or too little water**

Have you turned the tap on?

Is the water filter in the filter hose clean?

It needs cleaning from time to time.

Is the water pressure sufficient?

This fault may also occur if incoming water is drained due to the drain hose being lower than the required 30 cm from the base of the machine. Secure the outlet hose at the correct height and to start the machine, supply enough water to cover the heating element. Then start the programme.

### **3. The water immediately runs out again from the outlet hose**

Is the outlet hose at least 30 cm above the base of the appliance? Ensure that the bend at the end of the hose is not immersed in the pumped off water.

#### 4. Dishes not clean

Did you select the correct programme?

Did you use sufficient detergent? Did you use the recommended detergent?

Did you add the detergent correctly? Did you stack the dishes correctly?

Were the spray arms able to rotate without obstruction?

#### 5. Dishes not sparkling clean

Did you use a rinse aid recommended by us?

Is the correct quantity of rinse aid being dispensed?

If too little is used, marks are left, if too much is used, the dishes are smeared.

Was the screw cap of the salt container fastened securely?

#### **Did you add salt for the water softener in time?**

If you forgot, the water softener will work efficiently again by adding salt. After filling with salt, turn the starter button to the position for the final clear rinse and press the button for the hot programme. Wait until remaining programme is finished. For degrees of water hardness of up to 26°, temporarily set the slider at green then reset to orange or yellow.

Please use these hints for the smooth and satisfactory operation of the machine.

If you wish to avail yourself of our Customer Service to rectify one of the above faults, the necessary services cannot be supplied free of charge, even during the guarantee period. In other respects, please see the guarantee terms as set out in the Customer Service Booklet. If you cannot establish the cause of a fault, get in touch with our Customer Service Division. You will make their job easier if you are able to give them the 9 digit E-No. and serial number of the machine, which you will find on the rating plate under the worktop.

The AEG Comprehensive Service Contract offers you a wider guarantee. For a small annual payment you can sign a servicing contract with our Customer Service Division up to the 10th year of using your appliance. This guarantees you free rectification of all faults which may occur in your appliance.



## Capacity

14 place settings including servicing setting.

### One place setting contains:

- 1 soup dish, diameter approx. 24 cm
- 1 flat plate, diameter approx. 24 cm
- 1 dessert plate, diameter approx. 18.5 cm
- 1 teacup, diameter approx. 8.7 cm
- 1 saucer, diameter approx. 14 cm
- 1 tumbler about 7 cm  $\frac{1}{4}$  litre size
- 1 knife
- 1 fork
- 1 spoon
- 1 spoon
- 1 dessert spoon

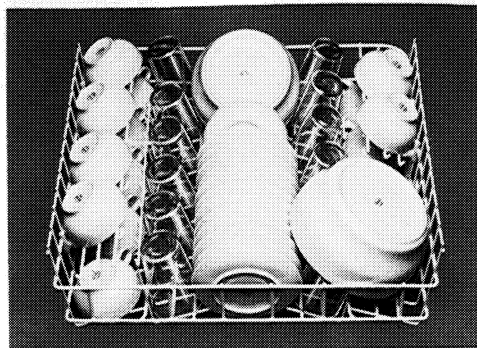

### One serving setting contains:

- 1 oval platter approx. 29.5 x 20 cm
- 1 round dish approx. 20 cm height approx. 9 cm
- 1 round dish approx. 17.5 cm height approx. 7.5 cm
- 1 fruit dish approx. 13 cm
- 2 serving spoons
- 1 serving fork
- 1 gravy spoon

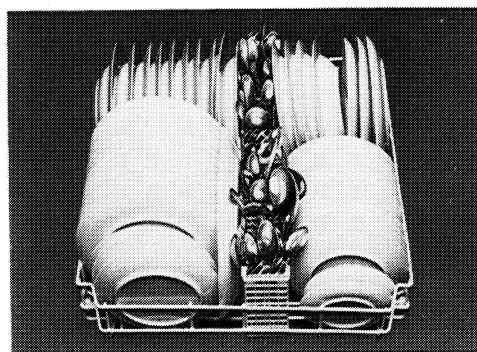





---

**AEG**