

FAVORIT 65050 VI

Fully Integrated Dishwasher

User Instructions



Dear customer,

Please read these user instructions carefully.

Please observe the safety instructions on the first few pages of these user instructions! Please keep these user instructions for later reference. Pass them on to any subsequent owner of the appliance.



The warning triangle and/or specific words (**Warning!**, **Caution!**, **Important!**) are used to highlight instructions that are important for your safety or for the function of the appliance. It is imperative that these instructions are observed.



This symbol or numbered instruction steps lead you step by step through the operation of the appliance.



Next to this symbol you receive additional information and practical tips on using the appliance.



Tips and instructions for the economical and environmentally conscious use of the appliance are marked with a clover leaf.

In the event of a malfunction, these operating instructions contain information on how to rectify faults yourself, see the "What to do, if..." section.

If these instructions are insufficient, please contact your AEG Service Force Centre.

In this respect please read the chapter "Service & Spare Parts".

Printed on paper manufactured with environmentally sound processes.
He who thinks ecologically acts accordingly ...

CONTENTS

Operating Instructions	5
Safety Instructions	5
Disposal	7
Economical and Ecological Dishwashing	7
Appliance Features, Display and Control Panel	8
Display and control panel	9
Prior to using for the first time	10
Water softener	10
Setting the water softener	11
Special salt for the water softener	12
Setting the amount of special salt to be added	12
Adding special salt	13
Rinse aid	14
Activating/deactivating the inflow of rinse aid	14
Adding rinse aid	15
Adjusting Rinse Aid Dosing	16
Activating/deactivating the acoustic signal	17
In Daily Use	18
Loading Cutlery and Dishes	18
Loading Cutlery	19
Loading Pans, Frying Pans and Large Plates	21
Loading Cups, Glasses and Coffee Services	23
Adjusting the Height of the Upper Basket	24
Filling with Detergent	25
Use of "3 in 1"/ Combi Detergent Tablets	26
Concentrated Detergent	27
Detergent tablets	27
Automatic Wash Programmes	27
Selecting the programme (Programme Table)	28
Starting a programme	29
Changing/interrupting/aborting a programme	29
Setting or changing the start delay	30
Load Sensing – Sensor Logic	31
Switching off the dishwasher	32

Care and Cleaning	32
Cleaning the Filter	33
What to do, if	34
...Error messages are displayed.	34
...there are problems with the operation of the dishwasher.	36
...the wash results are not satisfactory.	36
Technical Data	37
Notes for Test Institutes	38
Installation and Connection Instructions	39
Installing the Dishwasher	39
Fitting the Furniture Door Panel	40
Connecting the Dishwasher	41
Water Connection	41
Permitted water pressure	41
Connect the inlet hose	41
Water drain	43
Leak prevention system	44
Electrical Connection	44
Connections	45
Guarantee Conditions	46
Service and Spare parts	47

OPERATING INSTRUCTIONS



Safety Instructions

The safety aspects of AEG electrical appliances comply with accepted technical standards and the German Appliance Safety Law. Nevertheless, as a manufacturer we consider it our obligation to make you aware of the following safety information:

Installation, Connection and Placing into Operation

- The dishwasher may only be transported upright.
- Check the dishwasher for transport damage. Do not in any circumstances connect an appliance that is damaged. In the case of damage, please contact your retailer.
- Before installing the appliance, ensure that the nominal voltage and type of supply on the rating plate match that of the supply where the appliance is to be installed. The fuse rating is also to be found on the rating plate.
- For information on how to correctly install and connect up your dishwasher, please read the "Installation" section. Adaptors / connectors and extension cables must not be used.

Child Safety

- This appliance is designed to be operated by adults. Children should not be allowed to tamper with the controls or play with the product.
- Keep all packaging away from children.
- Keep all detergents in a safe place out of children's reach.
- The water in your dishwasher is not suitable for drinking. If there are still remnants of detergent in the appliance, there is a risk of burns!
- When disposing of an old appliance, cut off the power supply cable and remove any door catches, to prevent young children being trapped inside.

General Safety

- Repairs to the dishwasher are only to be carried out by qualified service engineers. Improper repairs can give rise to significant hazards for the user. If your appliance needs repairing, please contact your local AEG Service Force Centre.

- Never place the dishwasher in operation if the mains cable, water inlet or drain hose is damaged; or the control panel, work top or plinth area is damaged such that the inside of the appliance is freely accessible.
- If the mains lead is damaged, or is to be replaced for a longer lead, the cable (obtainable from AEG Service Force) must be replaced by a service engineer authorised by AEG.
- Never unplug the appliance by pulling on the cable, always pull the plug.
- Additions or modifications to the dishwasher are not permitted for safety reasons.
- Ensure that the door of the dishwasher is always closed when it is not being loaded or unloaded. In this way you will avoid anybody tripping over the open door and hurting themselves.
- Long bladed knives stored in an upright position are a potential hazard.
- Long and/or sharp items of cutlery such as carving knives must be positioned horizontally in the upper basket.
- When finished loading or unloading, close the door as an open door can be a hazard.

Correct Use

- Only wash household dishes using the dishwasher. If the appliance is used for other purposes, or is used incorrectly, the manufacturer cannot accept any liability for any damage caused.
- Only use detergents specifically designed for use in domestic dishwashers.
- Do not put any solvents in the dishwasher. There is a risk of an explosion!
- The anti-flood system provides dependable protection against damage due to leaks. For this system to function correctly, the following preconditions must be met:
 - The appliance must remain connected to the mains even when it is switched off.
 - The dishwasher must be correctly installed.
 - Always shut off the water supply at the tap when the dishwasher is not to be used for longer periods, e.g. when you are away on holiday.
- Do not sit or stand on the open door, the appliance may tip over.

- In the event of a fault, first close the tap, then switch off the appliance and unplug it from the mains. If the appliance is permanently wired to the mains: remove the fuse.



Disposal

Disposing of the Packaging Material

Dispose of the dishwasher packaging material correctly. All the packaging materials used are harmless to the environment and can be recycled.

- Plastic parts are marked with standard international abbreviations:
 - >PE< for polyethylene, e.g. sheet wrapping material
 - >PS< for polystyrene, e.g. padding material (always CFC-free)
 - >POM< for polyoxymethylene, e.g. plastic clips
- Cardboard packaging is manufactured from recycled paper and should be deposited in the waste paper collection for recycling.

Disposal of Old Appliances

When disposing of old appliances, remove the plug and ensure that any locks or catches are removed to prevent young children becoming trapped inside.

Use an authorised disposal site.



Economical and Ecological Dishwashing

- Ensure that the water softener is correctly adjusted.
- Do not pre-rinse dishes under running water.
- When you wash a small load, the load sensor calculates the amount of water necessary and shortens the programme. It is more economical to always wash with a full load.
- Select the wash programme to suit the nature and degree of the soiling on the dishes.
- Do not use more detergent, special salt or rinse aid than is recommended in these operating instructions and by the detergent manufacturer.

Appliance Features, Display and Control Panel

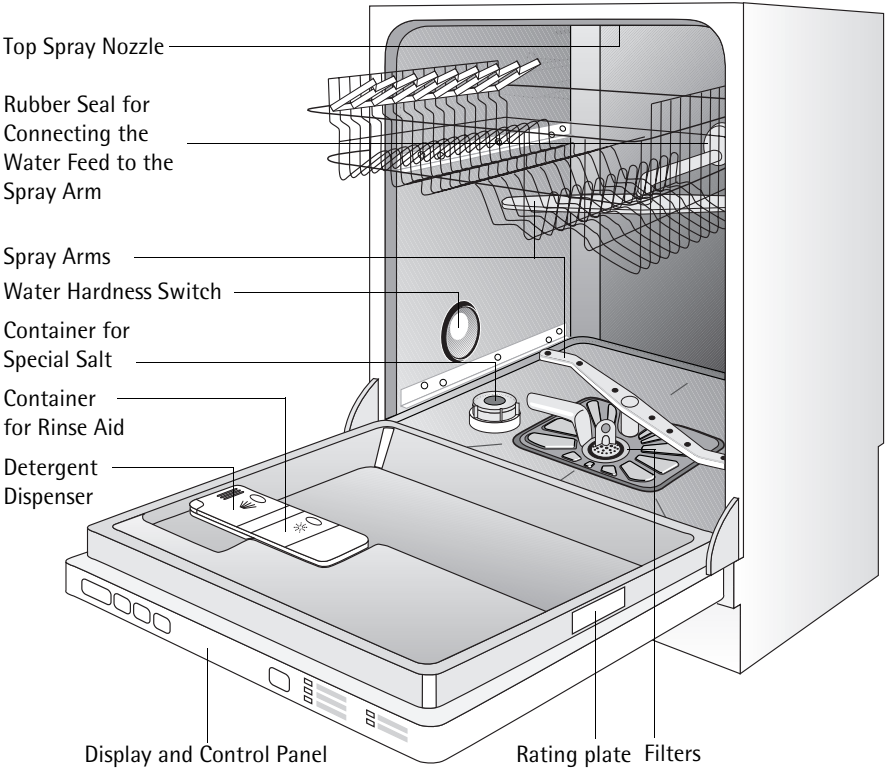

Display and control panel

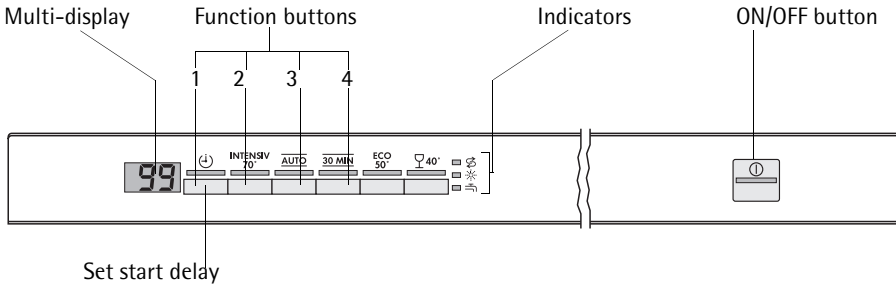



Function buttons: In addition to the programme and/or start delay selected, the following functions can also be set with the help of these buttons:

Function button 1	Set water softener
Function button 2	Activate/deactivate rinse aid inflow
Function button 3	Activate/deactivate acoustic signal
Function button 4	- not programmed -

The multi-display can indicate:

- the start delay that has been set.
- the estimated time remaining for the current programme.
- what type of error has occurred with the dishwasher.
- the level of hardness to which the water softener is set.
- whether the rinse aid inflow has been activated/deactivated.
- whether the acoustic signal has been activated/deactivated.

The indicators have the following meanings:

	Refill special salt
	Refill rinse aid
	Open the tap



The indicators are never illuminated while a programme is running.

Prior to using for the first time

Prior to using for the first time, remove all the clips with which the baskets are secured for transport.

Then perform the following steps:

1. Adjust the water softener
2. Fill with Salt for the Water Softener
3. Fill with Rinse Aid

Water softener

To avoid scale deposits on the dishes and in the dishwasher, the dishes must be washed with soft water, i.e. water with a low lime content. The dishwasher therefore has a built-in water softener, in which tap water with a hardness of 4°d (German degree) and harder is softened with the aid of special salt.



Your water supplier will be able to inform you about the hardness and hardness range of the water in your area.

The water softener can be set manually using the water hardness switch; it can also be set electronically using the buttons on the control panel.

Water hardness			Adjusting the hardness setting		Indication on the multi-display	Number of acoustic signals ¹
In °d ²	In mmol/l ³	Range	Manually	Electronically		
51 - 70	9,0 - 12,5	IV	1	10 ⁴	10L	10
43 - 50	7,6 - 8,9			9	9L	9
37 - 42	6,5 - 7,5			8	8L	8
29 - 36	5,1 - 6,4			7	7L	7
23 - 28	4,0 - 5,0			6	6L	6
19 - 22	3,3 - 3,9	III	0*	5	5L	5
15 - 18	2,6 - 3,2			4*	4L	4
11 - 14	1,9 - 2,5	II	0*	3	3L	3
4 - 10	0,7 - 1,8	I/II		2	2L	2
under 4	under 0.7	I		1 no salt necessary	1L	1

- 1) The water hardness will only be indicated acoustically if the acoustic signal has been activated.
- 2) (°d) German degree, measure of the hardness of water
- 3) [mmol/l] millimol per litre, international unit for the hardness of water
- 4) On this setting the length of the programme may be slightly longer.
- *) Factory setting

Setting the water softener

Using the table as a guide, adjust the water softener to that which corresponds to the hardness of the water in your area:



The dishwasher must be switched off.

Setting manually:

1. Open the dishwasher door.
2. Remove the lower basket from the dishwasher.
3. Turn the hardness range switch to 0 or 1 (see table).
4. Replace the lower basket.

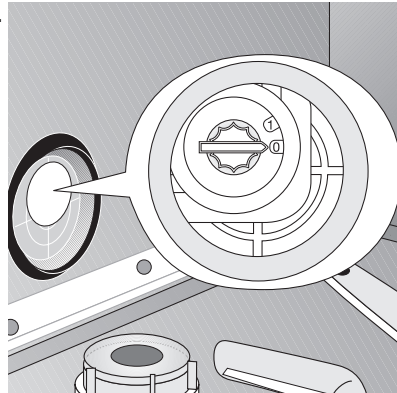

Setting electronically:

5. Press the ON/OFF button.
The LED indicators for all the buttons in the control panel that are now able to be selected will become illuminated.



If the only LED indicator illuminated is one that belongs to a programme button, this means that this programme has been activated. The programme must be cancelled (RESET):

Press function buttons **2** and **3** simultaneously for approx. 1 second.

The LED indicators for all the buttons in the control panel that are now able to be selected will become illuminated.

6. Press function buttons **2** and **3** simultaneously and keep them pressed.
The LED indicators in function buttons **1** to **3** will flash.
7. Press function button **1**.
The LED indicator for function button **1** will flash.
The multi-display will indicate the hardness setting.
The number of the acoustic signals heard (only when the acoustic signal has been activated) also corresponds to the hardness setting.
8. Pressing function button **1** increases the hardness setting by 1.
(Exception: hardness setting 1 follows hardness setting 10).

9. When the hardness setting is correct, press the ON/OFF switch.
The hardness setting is now saved.

Special salt for the water softener



If the water hardness in your area is less than 4 °d, then the water in your dishwasher does not need to be softened and you do not need to use special salt or salt substitute.

Water can be softened in one of two ways:

- If you are using dishwasher detergent that already contains salt substitute, the detergent only is put into the detergent compartment.
 - In this case the water softener must **manually be set to 0 and electronically to 1** to ensure that no special salt is added.
- If you are using dishwasher detergent and special salt separately, the special salt is to be put into the salt container.
 - In this case the water softener must **manually be set to 0 and electronically to between 2 and 10** (depending on the water hardness in your area) to ensure that the special salt is dispensed from the salt container.





Only use special salt intended for dishwashers. Never fill the salt supply container with different types of salt (e.g. cooking or table salt) or detergent. This would destroy the water softener.
Prior to filling with salt, please check each time that you really do have a packet of special salt in your hand.

Setting the amount of special salt to be added



Some appliances are equipped with an additional **3 in 1** function. If you use 3-in-1 dishwashing tablets and select the **3 in 1** function together with the programme, the inflow of special salt does not have to be deactivated (see "**3 in 1** function").

-  **1.** Set the water softener manually and electronically to the desired water hardness:

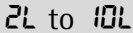
Manual setting	Electronic setting	Multi-display indicator	Addition of special salt
0	1		Do not add special salt.
0 - 1	2-10		Addition of special salt via salt container (factory setting)

-  If the water softener is electronically set at "1" for the purpose of using detergent that includes special salt, the special salt indicator is deactivated.

Adding special salt

If you are using dishwasher detergent and special salt separately, add the special salt:

- Before using the dishwasher for the first time.
- When the indicator for special salt  is illuminated on the control panel.

-  **1.** Open the door, remove the lower basket.
- 2.** Undo the lid on the salt container by turning it anticlockwise.
- 3. When using for the first time:** fill the salt container with water.
- 4.** Place the funnel supplied on the container opening.
Fill the container with salt through the funnel; the capacity of the container is approx. 1.0-1.5 kg depending on the grain size. Do not overfill the salt container with salt.

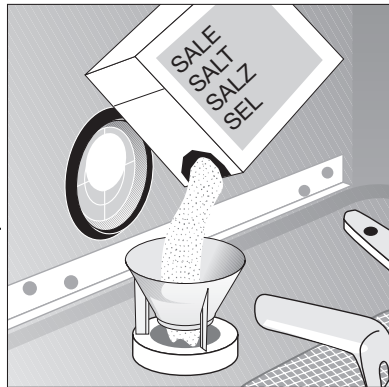

-  The water expelled by filling the salt container with salt runs out of the salt container onto the base of the washing compartment. This is not a cause for concern, the water will be pumped out at the start of the next wash programme.

- 5.** Clean any salt remnants on the container opening.

6. Turn the lid clockwise to the stop, otherwise dishwasher salt will leak into the wash water, this could lead to poor wash results. To avoid this run a rinse programme after filling the salt container with special salt. This will wash away salt water and any salt crystals that have been spilt.



Depending on the size of the salt grains, it can take several hours for the salt to dissolve in the water and the special salt indicator  to extinguish. The setting of the water softener and the consumption of salt are dependent on the hardness of the local water.

Rinse aid

Rinse aid ensures that your dishes gleam and are free from spots, and that your glasses are clear.

Rinse aid can be added in one of two ways:

- If you are using dishwasher detergent that already contains rinse aid, the detergent including the rinse aid is put into the detergent compartment.
 - In this case the dispensing of rinse aid from the supply container must be **deactivated** to avoid a double dosage.
- If you are using dishwasher detergent and rinse aid separately, the rinse aid is to be put into the rinse aid supply container.
 - In this case the dispensing of rinse aid from the supply container must be **activated**.
 - The amount of rinse aid to be dispensed **must** be set.



Use only branded rinse aid for dishwashers. Never fill the rinse aid container with any another substance (e.g. concentrated vinegar) or dishwasher cleaning agent. This would damage the appliance.

Activating/deactivating the inflow of rinse aid



Some appliances are equipped with an additional **3 in 1** function. If you use 3-in-1 dishwashing tablets and select the **3 in 1** function together with the programme, the inflow of rinse aid does not have to be deactivated (see "**3 in 1** function").

1. Press the ON/OFF button.
The LED indicators for all the buttons in the control panel that are now able to be selected will become illuminated.



If the only LED indicator illuminated is one that belongs to a programme button, this means that this programme has been activated. The Programme must be cancelled (RESET):

Press function buttons **2** and **3** simultaneously for approx. 1 second. The LED indicators for all the buttons in the control panel that are now able to be selected will become illuminated.

2. Press function buttons **2** and **3** simultaneously and keep them pressed. The LED indicators for function buttons **1** to **3** will flash.
3. Press function button **2**. The LED indicator for function button **2** will flash. The multi-display will indicate the current setting:

0d	Inflow of rinse aid is deactivated
1d	Inflow of rinse aid is activated (factory setting)

4. Pressing function button **2** will change the setting.
5. Once the multi-display is indicating the required setting, press the ON/OFF button. The setting is now saved.

Adding rinse aid

If you are using dishwasher detergent and rinse aid separately, add the rinse aid:

- Before using the dishwasher for the first time.
- When the  indicator on the control panel is illuminated.

The rinse aid compartment is on the inside of the dishwasher door.



1. Open the door.
2. Press the rinse aid compartment release button with your finger.
3. Fully open the rinse aid compartment lid.

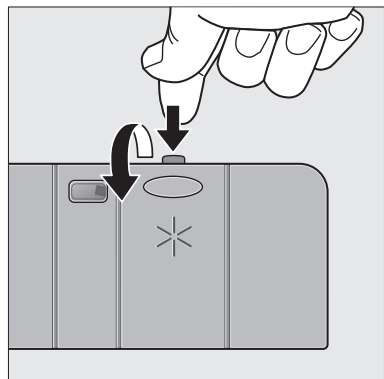

4. Fill with rinse aid exactly up to the level marked "max"; this corresponds to a quantity of approx. 140 ml.
5. Close the lid and press until it locks into place.
6. Wipe up any spilt rinse aid with a cloth. Otherwise too much foam will be formed during the wash.

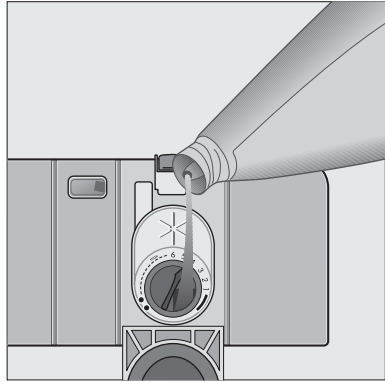

Adjusting Rinse Aid Dosing



As the dishes are washed rinse aid is released from the dispenser into the wash water. The dose is factory set at 4, and can be adjusted from 1 to 6. Only change the setting if streaks, milky spots or dried on water marks are visible on glasses or crockery.

1. Open the door of the dishwasher.
2. Press the rinse aid compartment release button with your finger.
3. Fully open the rinse aid compartment lid.
4. Set the dose level.
5. Close the lid and press until it locks into place.
6. If rinse aid has spilt, wipe up with a cloth.

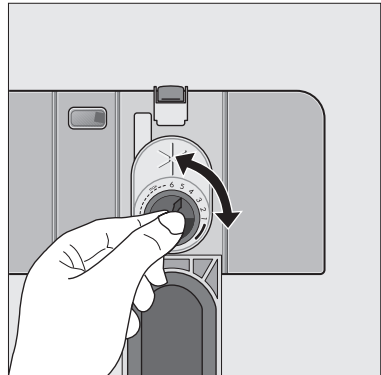

Activating/deactivating the acoustic signal

The acoustic signal can indicate acoustically:

- at which water hardness the water softener is set.
- when a programme has finished.
- when an error has occurred with the dishwasher.

You can switch on/off the acoustic signal in the following way:

1. Press the ON/OFF button.

The LED indicators for all the buttons in the control panel that are now able to be selected will become illuminated.



If the only LED indicator illuminated is one that belongs to a programme button, this means that this programme has been activated. The programme must be cancelled (RESET):

Press function buttons **2** and **3** simultaneously for approx. 1 second. The LED indicators for all the buttons in the control panel that are now able to be selected will become illuminated.

2. Press function buttons **2** and **3** simultaneously and keep them pressed. The LED indicators for function buttons **1** to **3** will flash.
3. Press function button **3**.
The multi-display will indicate the current setting:

0 b	Acoustic signal deactivated
1 b	Acoustic signal activated (ex-factory setting)

4. Pressing function button **3** will change the setting.
5. Once the multi-display is indicating the required setting, press the ON/OFF button. The setting is now saved.

In Daily Use

- Check the salt and rinse aid levels.
- Load cutlery and dishes into the dishwasher
- Fill with dishwasher detergent
- Select a wash programme suitable for the cutlery and dishes
- Start the wash programme

Loading Cutlery and Dishes



Sponges, household cloths and any object that can absorb water should not be washed in the dishwasher.

For washing in the dishwasher the following cutlery/dishes

are not suitable:	are of limited suitability:
<ul style="list-style-type: none"> • Cutlery with wooden, horn, china or mother of pearl handles • Plastic items that are not heat resistant • Older cutlery with glued parts that is not temperature resistant • Bonded cutlery items or dishes • Pewter or copper items • Lead crystal glass • Steel items subject to rusting • Wooden platters • Items made from synthetic fibres 	<ul style="list-style-type: none"> • Only wash stoneware in the dishwasher if it is specifically marked as being dishwasher-safe by the manufacturer. • Glazed patterns may fade if machine washed frequently. • Silver and aluminium parts have a tendency to discolour during washing. Left-overs, e.g. egg white, egg yolk and mustard often cause discolouring and staining on silver. Therefore always clean left-overs from silver immediately, if it is not to be washed straight after use. • Some types of glass can become dull after a large number of washes.

- Before loading the dishes, you should:
 - Remove all scraps of food.
 - Soften remnants of burnt food in pans.
- When loading the dishes and cutlery, please note:
 - Dishes and cutlery must not impede the rotation of the spray arms.
 - Load hollow items such as cups, glasses, pans, etc. with the opening downwards so that water cannot collect in the container or a deep base.
 - Dishes and items of cutlery must not lie inside one another, or cover each other

- To avoid damage to glasses, they must not touch
- Do not lay small objects (e.g. lids) in the cutlery rack

Loading Cutlery



Long bladed knives stored in an upright position are a potential hazard.



Long and/or sharp items of cutlery such as carving knives must be positioned horizontally in the upper basket.



Take care when loading or unloading sharp items such as knives.

To ensure that all items of cutlery are completely washed, you should

-  **1.** Place the grid insert on the cutlery rack
- 2.** Place short knives, forks and spoons in the grid insert with their handles pointing downwards.
- 3.** For larger items of cutlery, e.g. a whisk, half of the top for the cutlery basket can be left off.

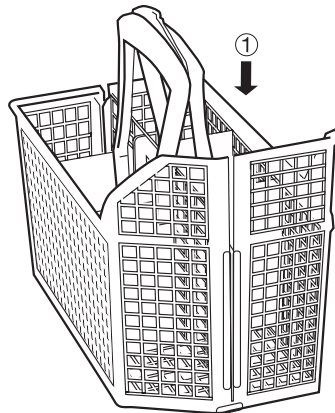
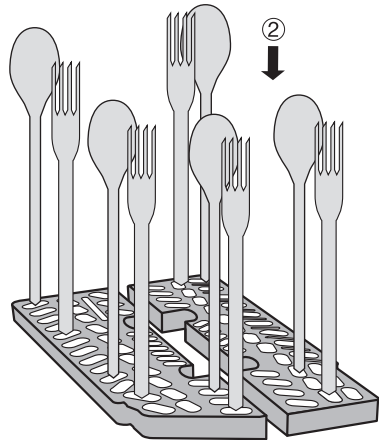

On some models of dishwasher it is possible to open the cutlery basket.



To ensure that the cutlery rack cannot open on removal from the appliance, you should always hold both parts of the two part handle.

-  **1.** Place the cutlery rack on a table or work surface
- 2.** Open the two part handle
- 3.** Remove cutlery
- 4.** Close the two part handle.

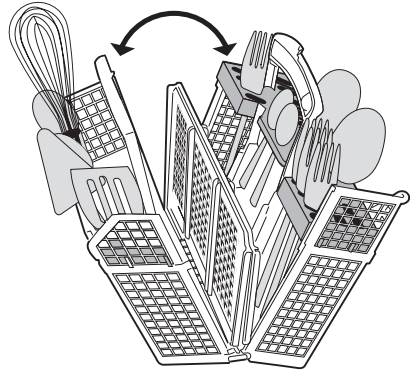

Loading Pans, Frying Pans and Large Plates

Load large and heavily soiled dishes in the lower basket (Plates up to 29cm in diameter).

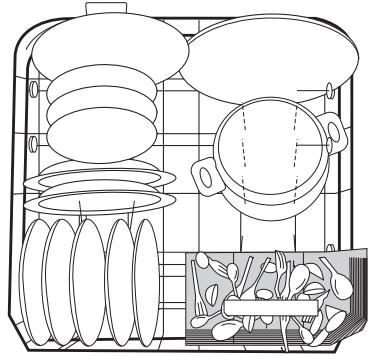

Your dishwasher has one of the following four types of lower basket:

Type 1: None of the plate inserts in the lower basket can be removed

Type 2: The right-hand plate inserts in the lower basket can be folded over to the left



To ease the loading of large items, the two right-hand plate inserts in the lower basket can be folded over to the left

1. Slightly lift the right plate inserts.

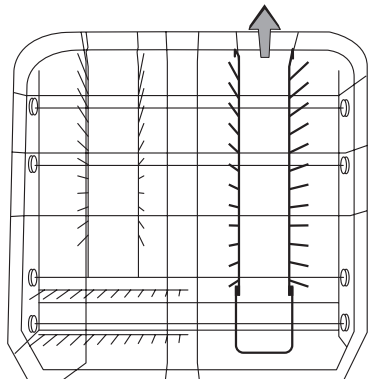

2. Fold the plate inserts to the left.

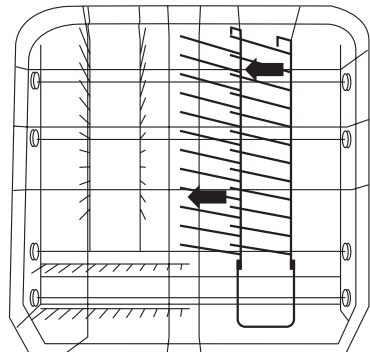

Type 3: The right-hand plate inserts in the lower basket can be folded across one another



To ease the loading of large items, the two right-hand plate inserts in the lower basket can be folded across one another.

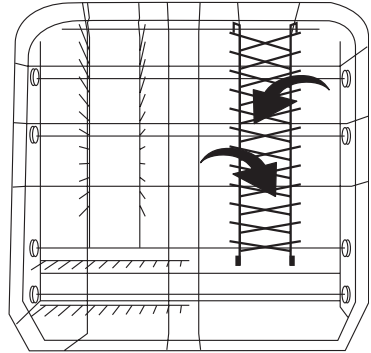

Type 4: The two rear plate inserts in the lower basket can be folded across one another



To ease the loading of large items, the two rear plate inserts in the lower baskets can be folded across one another.

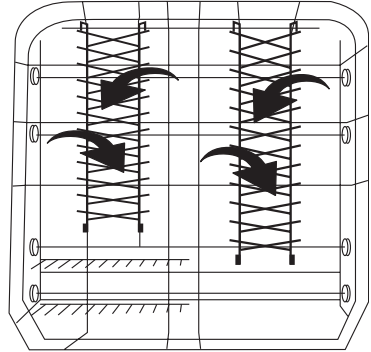

Loading Cups, Glasses and Coffee Services

Load small, delicate items and long pointed cutlery in the upper basket.

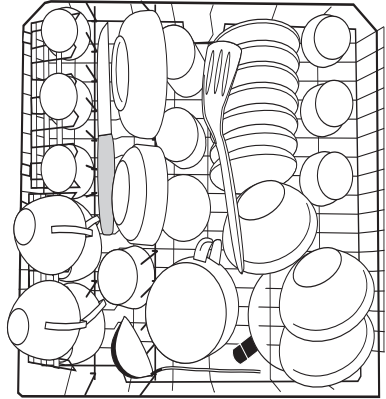

- Arrange items of crockery on the folding cups racks so that they are offset from each other and water can reach all items.
- The cup racks can be folded up out of the way for tall items.
- Lay or hang wine, champagne, and brandy glasses in the cut outs on the cup racks.
- Glasses, beakers, etc. can also be placed on the two rows of prongs on the left of the upper basket.

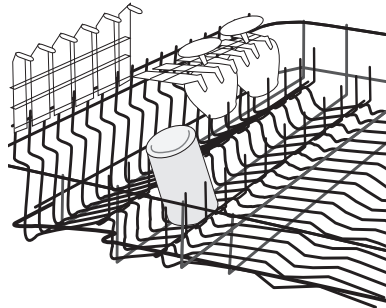

Adjusting the Height of the Upper Basket

	Maximum Height of the Dishes in the	
	Upper Basket	Lower Basket
With upper basket raised	22 cm	31 cm
With upper basket lowered	24 cm	29 cm

i The height of the basket can also be adjusted when it is loaded.

Lowering the Upper Basket:

- 1.** Pull the upper basket out completely.
- 2.** Holding the upper basket at the rear right, lift it as far as it will go and then lower it vertically. The upper basket will engage in the lower position.

Raising the Upper Basket:

- 1.** Pull the upper basket out completely.
- 2.** Holding the upper basket at the rear right, lift it as far as it will go and then lower it vertically. The upper basket will engage in the higher position.

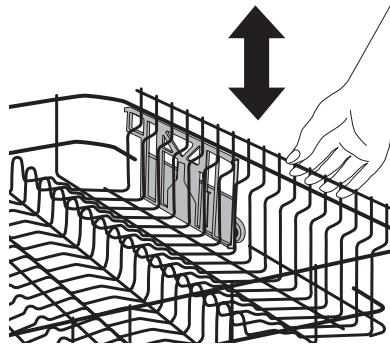

Filling with Detergent



Only use dishwasher detergent.

Fill with detergent:

– Prior to the start of a wash programme (not for the pre wash programme). The detergent is released into the wash water during the programme.



Please observe the manufacturer's dosing and storage recommendations as stated on the detergent packaging.

The detergent compartment is on the inside of the dishwasher door.



1. If the lid is closed: press release button (1). The lid springs open.

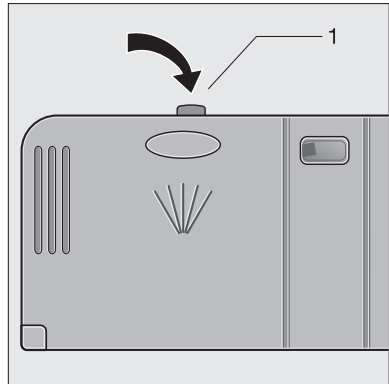

2. Fill the detergent dispenser with detergent. The markings indicate the dosing levels: "20" corresponds to approx. 20 ml of detergent, "30" corresponds to approx. 30 ml of detergent.
3. Close the lid and press until it locks into place.



If the dishes are very heavily soiled put additional detergent into the adjacent chamber (2). This detergent will take effect during the pre wash.

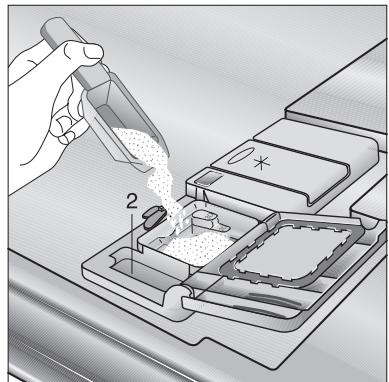

Use of "3 in 1"/ Combi Detergent Tablets

General Advice

These products are tablets with combined detergent/rinse-aid and salt functions.

-  1. Before using these products you should first check that the water hardness in your supply is compatible with the use of these products as per the detergent manufacturers instructions (on the product packaging).
2. These products should be strictly used according to the detergent manufacturers instructions.



Do not place the tablets in the tub or the cutlery basket as this will result in poorer wash results. The tablets should be placed in the detergent doser.

3. If you encounter problems when using "3 in 1" products for the first time then please contact the detergent manufacturers care line (the telephone number is given on the product packaging).

Special Advice

When using combination products, the rinse-aid and salt lights are no longer useful. It may be helpful therefore to switch the rinse aid off - please note that only some dishwashers have this facility - and selecting the lowest possible setting for water hardness.

For more information please refer to your instruction manual.

If you decide to switch to the use of a standard detergent system we advise that you:

- Refill both the salt and rinse aid compartments.
- Switch the waterhardness setting to the highest possible position and run for three normal cycles without a load.
- Readjust the waterhardness setting again according to the conditions for your region (as per the instruction manual).

Concentrated Detergent

Based on their chemical composition, dishwasher detergents can be split into two basic types:

- **conventional**, alkaline **detergents** with caustic components
- low alkaline **concentrated detergents** with natural enzymes.



The use of 50 °C wash programmes in conjunction with concentrated detergents reduces pollution and is good for your dishes; these wash programmes are specially matched to the dirt-dissolving properties of the enzymes in the concentrated detergent. For this reason 50 °C wash programmes in which concentrated detergents are used can achieve the same results that can otherwise only be achieved using 65 °C programmes.

Detergent tablets



Detergent tablets of different makes dissolve at different speeds. For this reason some detergent tablets cannot develop their full cleaning power during short programmes. Therefore please use wash programmes with pre wash when using detergent tablets.

Automatic Wash Programmes

During the AUTOMATIC programmes the amount of soiling on the dishes is determined by how cloudy the water is.

If the appliance is partially loaded and the dishes lightly soiled, the "pre wash", "main wash" and "rinsing" elements of the programme are shorter and the water consumption level is lower.

If the appliance is fully loaded and the dishes heavily soiled, the "pre wash", "main wash" and "rinsing" elements of the programme are longer and the water consumption level is higher.

For this reason the programme duration, water and energy consumption levels can vary within the stated range for AUTOMATIC programmes (see Programme Table).

In this way, the dishes are always optimally washed while water and electricity consumption are kept low.

During AUTOMATIC programmes the temperature of the wash water is also automatically adjusted to between 50 °C and 65 °C depending on the amount of soiling on the dishes.



Selecting the programme (Programme Table)

Choose the most suitable programme with the aid of this table:

Type of dishes	Dinner service and cooking items		Dishes excluding saucepans	Coffee service and dessert dishes	
Including	-	-	-	including fragile glasses	
Type of soiling	<ul style="list-style-type: none"> heavily soiled dried-on leftovers, in particular egg white and thickeners 	<ul style="list-style-type: none"> normally soiled dried-on leftovers 	<ul style="list-style-type: none"> just used, normally to lightly soiled 	<ul style="list-style-type: none"> normally to lightly soiled 	<ul style="list-style-type: none"> lightly soiled
Suitable programme:	INTENSIV 70°	AUTO	30 MIN ¹	ECO 50° ²	 40°
Cycle sequence ³	Pre-wash Main wash 2x intermediate rinses Final rinse Dry	Pre-wash Main wash Intermediate rinse Final rinse Dry	- Main wash - Final rinse -	Pre-wash Main wash Intermediate rinse Final rinse Dry	- Main wash 2x intermediate rinses Final rinse Dry
Consumption values: ⁴	↓	↓	↓	↓	↓
Length ⁵	110 - 120 min.	90 - 110 min.	30 min.	130 - 150 min.	73 min.
Energy	1.75 - 1.95 kWh	1.1 - 1.4 kWh	0.8 kWh	0.95 - 1.05 kWh	0.9 kWh
Water	19 - 21 litres	12 - 19 litres	9 litres	13 - 15 litres	14 litres

- 1) This programme is not suitable for dishes with dried-on leftovers.
- 2) Test programme for test institutes
- 3) The various stages in the programme have different volumes as the dishes are washed more intensely for short periods during certain stages of the programme to improve the effectiveness of cleaning.
- 4) The consumption values were obtained under standardised conditions. They are dependent on how full the basket are. Variations are therefore possible in practice.
- 5) If the water hardness is electronically set at level 10, the length of the programme may be slightly longer.

Starting a programme

-  **1.** Check that the dishes and cutlery are loaded in the dishwasher in such a way that the spray arms are free to rotate.
 - 2.** Turn on the tap fully.
 - 3.** Press the ON/OFF button.
The LED indicators for all the buttons in the control panel that are now able to be selected will become illuminated.
 - 4.** Press the relevant button for the programme required (see "Programme Table").
The programme display will become illuminated.
The remaining time for the programme will be shown in the multi-display.
-  The remaining time for the programme is adjusted according to amount of dishes, degree of soiling, etc.
- 5.** Close the dishwasher door. The programme will begin.
-  If an error message is displayed in the multi-display and/or if an acoustic error message can be heard after the programme has begun, please read the section "What to do if ...".



Changing/interrupting/aborting a programme

-  Only change or interrupt a programme that is in progress if it is absolutely necessary. After the appliance has been closed again, the air that has entered will be heated significantly and expand. As a result, water may collect in the base of the appliance and trigger the anti-flood system.

Changing a programme

-  If you would like to change the programme before closing the dishwasher door, briefly press the button for the new programme.

If you would like to change the programme after it has commenced, proceed as follows:

-  Hot steam may escape when the dishwasher door is opened. There is a risk of scalding! Be careful when opening the door of the dishwasher.
-  **1.** Open the door of the dishwasher. The programme will stop.
 - 2.** Press the button for the new programme and hold it down.
First, the indicator for the programme that is currently running will flash.

After several seconds only the indicator for the new programme will be flashing.

3. Release the programme button.
4. Close the dishwasher door. The newly selected programme will commence from the beginning.

Interrupting the programme by opening the dishwasher door

-  1. Open the door of the dishwasher. The programme will stop.
2. Close the dishwasher door. The programme will continue.



Aborting the programme (RESET)

-  1. Open the door of the dishwasher.
2. Press function buttons **2** and **3** for approx. 1 second and keep them pressed.
The LED indicators for all the buttons in the control panel that are now able to be selected will become illuminated.
3. Release the function buttons.
The programme has been aborted.
4. Switch off the dishwasher by pressing the ON/OFF button.

Setting or changing the start delay

Using the start delay timer you can adjust when within the next 19 hours the programme is to begin.

Setting the start delay:

-  1. Open the door of the dishwasher.
2. Press the ON/OFF button.
The LED indicators for all the buttons in the control panel that are now able to be selected will become illuminated.
3. Continue pressing the  button until the number of hours until the programme is to start is flashing in the multi-display.
4. Press the button for the desired programme.
The length of the selected programme will flash for a moment in the multi-display, and then the selected starting time will be displayed again.
5. Close the door.
The programme will start automatically following a countdown of the hours set.

Changing the start delay:

As long as the programme has not started, you are still able to cancel the start delay by pressing the (⏸) button.

Cancelling the start delay:

As long as the programme has not started you are still able to cancel the start delay. Continue pressing the (⏸) button until the length of the selected programme appears in the multi-display. The selected programme will begin immediately after the dishwasher door has been closed.

Changing the programme after the start delay has been set:

As long as the programme has not started, you are still able to change the start delay set by pressing a programme button.

-  **1.** Press the button for the new programme and hold it down.
First, the indicator for the programme that has just been selected will flash.
After several seconds only the indicator for the new programme will be flashing.
- 2.** Release the programme button.
- 3.** Close the door.
The programme will start automatically following a countdown of the hours set.

Load Sensing – Sensor Logic

If a wash programme is started even though there are only a few dishes in the upper and/or lower basket, an intelligent electronic system adjusts the amount of water and the duration of the wash programme to the number of dishes. By this means it is possible to wash only a few dishes quickly and economically. At half load (6 place settings), up to 2 litres of water and 0.2 kWh of electricity are saved.

Switching off the dishwasher

If the acoustic signal has been enabled, a continuous tone will sound for 15 seconds at the end of the programme.



Hot steam may escape if the door is opened immediately after the programme has ended. Therefore:



1. Open the door carefully.
2. Switch off the dishwasher by pressing the ON/OFF button. All display indicators will go out.

If you do not switch off the dishwasher, the acoustic signal will sound again 3 minutes later and 6 minutes later.



Removing the dishes

- Hot dishes are sensitive to knocks. The dishes should therefore be allowed to cool before they are removed.
- Leave the dishes in the dishwasher for approximately 15 minutes following the end of the programme to enable better drying and cooling down of dishes.
- Empty the lower basket first, then the upper basket. This will avoid water spots, which are caused by remaining water in the upper basket dripping onto the dishes in the lower basket.

Care and Cleaning



Do not under any circumstances use furniture care products or aggressive cleaners.

- If necessary, clean the controls only with a soft cloth and pure warm water.
- Occasionally check the internal containers, door seal, and water inlet for soiling, clean if necessary.

Cleaning the Filter

i The filters should be checked and cleaned regularly. Dirty filters will give poor wash results.

- 1.** Open the door, remove the lower basket.
- 2.** The dishwasher filter system comprises a coarse/fine filter, microfilter and a flat filter. Unlock the filter system using the handle on the microfilter, and remove.
- 3.** Turn the handle about ¼ a turn anti-clockwise and remove.
- 4.** Take hold of the coarse/fine filter (1/2) by the handle with the hole and remove from the microfilter (3)
- 5.** Clean all filters thoroughly under running water.
- 6.** Remove the flat filter (4) from the base of the washing compartment and clean both faces thoroughly

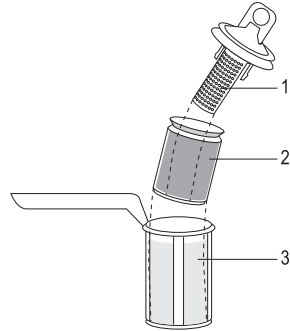
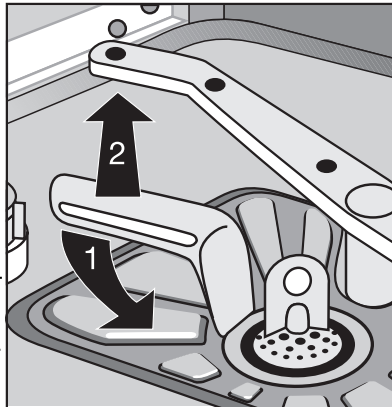

- 7.** Put the flat filter back in the base of the washing compartment
- 8.** Place the coarse/fine filter in the microfilter and press together.
- 9.** Put the filter combination in place and lock by turning the handle clockwise to the stop. During this process ensure that the flat filter does not protrude above the base of the washing compartment.

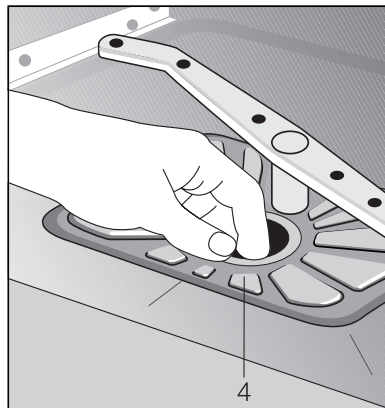

! The dishwasher must not be used without filters under any circumstances.

What to do, if ...

Try to rectify minor faults on the dishwasher with the aid of the instructions given here. If you call an engineer to resolve a of fault listed here, or to repair a fault caused by incorrect use or installation, a charge will be made even if the appliance is in guarantee.



...Error messages are displayed.

If your appliance is equipped with an optical floor signal, in the event of an error a dot-shaped optical signal will flash on the floor.



Errors will only be indicated acoustically if the acoustic signal has been activated.

If, as listed in the table below, any of the indicators in the control panel or the display panel are flashing or are illuminated, and/or if an acoustic signal can be heard, you can probably rectify the fault yourself.

Malfunction	Possible cause	Remedy
<p>One continuously repeated warning tone can be heard; the programme indicator for the selected programme is flashing: The  indicator is continuously illuminated: Error code  is displayed in the multi-display: There is no water running into the dishwasher.</p>	The tap is blocked or furred with lime-scale.	Clean tap.
	The tap is turned off.	Turn the tap on.
	The filter (where present) in the threaded hose fitting at the water inlet valve is blocked.	Clean the filter in the threaded hose fitting.
	Filters in the base of the washing compartment are blocked.	Press the button for the commenced programme; then abort the programme by pressing RESET (see chapter: "Starting a programme"); Starting a programme clean out the filters (see chapter: "Cleaning the filters").
	The water inlet hose has not been correctly laid.	Check hose installation.

Malfunction	Possible cause	Remedy
Two short continuously repeated warning tones can be heard; the programme display for the selected programme is flashing; error code 120 is displayed in the multi-display.	The siphon is blocked.	Clean out siphon.
	The water drain hose has not been correctly laid.	Check hose installation.
Three short continuously repeated warning tones can be heard, error code 130 is displayed in the multi-display.	The leak prevention system has been triggered.	Turn off the tap and contact your local Service Force Centre.

After rectifying an **110** or **120** error, press the button for the commenced programme. The programme will continue.

If the fault is displayed again, please contact your local Service Force Centre.



For all other errors displayed, please contact your local Service Force Centre stating the error code (see chapter: Service and Spare Parts).

...there are problems with the operation of the dishwasher.

Symptom	Possible Cause	Solution
The programme does not start.	The door of the dishwasher is not closed properly.	Shut the door.
	Mains plug is not plugged in.	Insert mains plug.
	House fuse is defective.	Replace fuse.
	A start delay is selected.	If dishes are to be washed immediately cancel delay start timer.
Rust spots are visible in the washing compartment.	The washing compartment is made from rust-free stainless steel. Rust spots in the washing compartment are due to rust particles from external sources (rust particles from water pipes, pans, cutlery, etc.). Remove such spots with one of the stainless steel cleaners that are generally available on the market.	Only wash cutlery and dishes that are suitable for dishwasher use. Close the lid of the special salt container securely.
There is a whistling noise during washing.	The whistling is not a cause for concern.	Use a different brand of detergent.

...the wash results are not satisfactory.

The dishes are still dirty.

- The wrong wash programme was selected.
- The dishes were loaded in such a way that the wash water did not reach all items. The baskets for the dishes must not be overloaded.
- The filter in the base of the washing compartment is dirty or incorrectly positioned.
- Detergent was not used or too little was used.
- In the case of scale deposits on the dishes: The special salt container is empty or the water softener is incorrectly adjusted.
- The drain hose is incorrectly laid.

The dishes are wet and dull.

- Rinse aid was not used.
- The rinse aid container is empty.

There are streaks, milky spots or a bluish coating on glasses and dishes.

- Lower rinse aid dosing.

There are dried water drops on the glasses and dishes.

- Increase rinse aid dosing.
- The detergent may be the cause. Contact the detergent manufacturer's customer advisor.

Technical Data

Capacity:	12 place settings including serving dishes
Permitted Water Pressure:	1-10 bar (=10-100 N/cm ² = 0.1-1.0 MPa)
Electrical Connection:	Information on the electrical connection is given on the rating plate on the inner edge of the dishwasher door on the right.
Dishwasher: Free-Standing Appliances	
Dimensions:	850 x 600 x 600 (H x W x D in mm)
Max. Weight:	54 Kg
Dishwashers that Can Be Integrated, Built-In Dishwashers	
Dimensions:	820 – 880 x 596 x 570 (H x W x D in mm)
Max. Weight:	50 Kg
Dishwashers that Can Be Fully Integrated	
Dimensions:	820 – 880 x 596 x 546 - 550 (H x W x D in mm)
Max. Weight:	50 Kg

CE This appliance conforms with the following EU Directives:

- 73/23/EWG dated 19. 02. 1973 – Low Voltage Directive
- 89/336/EWG dated 03. 05. 1989
(including Directive Amendment 92/31/EWG) – EMC Directive

Notes for Test Institutes

Testing in accordance with EN 60704 must be carried out with the appliance fully loaded and using the test programme (see Programme Table).

Tests in accordance with EN 50242 must be carried out when the salt dispenser and rinse aid container have been filled with salt and rinse aid respectively and using the test programme (see Programme Table).

	Full Load: 12 place settings incl. serving dishes	Half Load: 6 place settings incl. serving dishes, leaving alternate positions free
Detergent Dosing:	5g + 25g (Type B)	20g (Type B)
Rinse Aid Setting:	4 (Type III)	4 (Type III)

Sample loading arrangements: Upper basket

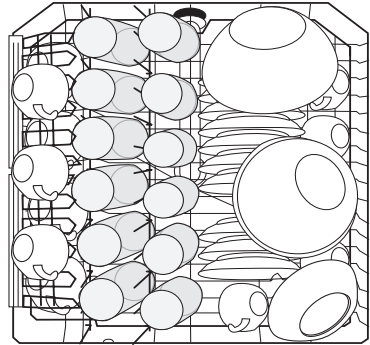
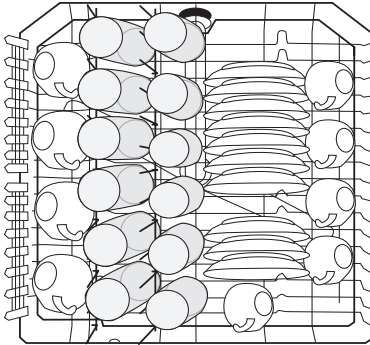

Lower basket with cutlery basket

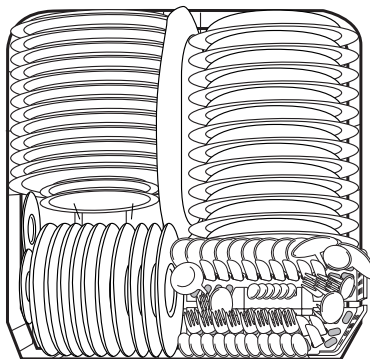

Cutlery basket

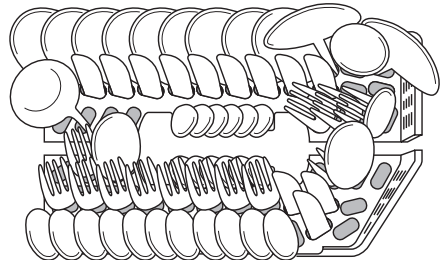

INSTALLATION AND CONNECTION INSTRUCTIONS

Installing the Dishwasher

- The dishwasher must be installed on a firm floor and adjusted to ensure that it is stable and level.
- To compensate for unevenness in the floor and to match the height of the appliance to that of surrounding units extend the threaded feet by unscrewing:
 - use a screwdriver.

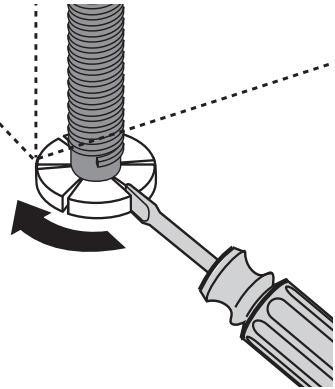

- For built-in, integrated and fully integrated dishwashers, the rear feet should be adjusted from the front of the appliance using a screwdriver.
- The drain hose, inlet hose and mains cable must not be kinked or crushed when the dishwasher is in position.
- In addition, the dishwasher must be firmly screwed to the work surface or to the neighbouring units. This is essential to ensure the dishwasher does not tip.

Fitting the Furniture Door Panel

(see installation template supplied)



The door of the appliance can be fitted with a furniture door panel of the following dimensions:

Width:	591 mm – 594 mm
Thickness:	16 mm – 24 mm
Height:	max. 715 mm
Weight:	max. 10 kg

Connecting the Dishwasher

Water Connection

The dishwasher is fitted with safety devices that prevent the wash water returning into the drinking water system and comply with the applicable plumbing regulations.

- The dishwasher must be connected to a cold water supply.
- The dishwasher **must not** be connected to open hot water appliances or instantaneous water heaters.

Permitted water pressure

Lowest permitted water pressure: 1 bar (=10 N/cm ² =100 kPa)	Consult your installer if the water pressure is less than 1 bar.
Highest permitted water pressure: 10 bar (=100 N/cm ² =1 MPa)	In the case of a water pressure greater than 10 bar, a pressure reduction valve must be used (available from your dealer).

Connect the inlet hose



The water inlet hose must not be kinked, crushed or entangled when it is being connected up.



Connect the threaded hose fitting (ISO 228-1:2000) on the water inlet hose to a tap with an external thread (3/4 inch). Tighten the threaded hose fitting **hand tight only**.



- In order that access to the tap in the kitchen is not limited by the use of the dishwasher, we recommend the installation of an additional tap, or fitting a two way adapter to the existing tap.
- If you need a longer water inlet hose than that supplied, VDE approved complete hose sets are to be used. These are available from your local Service Force Centre.
- Do not use, for connection, old hoses which have been used for another appliance.

i The following section is only applicable to dishwashers that have a safety valve on the threaded hose fitting for the tap:

Water inlet hose with safety valve

After connecting the double-walled water inlet hose, the safety valve is next to the tap. Therefore the water inlet hose is only under pressure while the water is running. If the water inlet hose starts to leak during this operation, the safety valve cuts off the running water and the draining pump in the dishwasher is switched on.



Please take care when installing the water inlet hose:

- The distance between the bottom edge of the safety valve and the floor on which the dishwasher is standing must be at least 30 cm:
- The electrical cable for the safety valve is in the double-walled water inlet hose. Do not immerse the water inlet hose or the safety valve in water.
- If the water inlet hose or the safety valve is damaged, remove the mains plug immediately.
- A water inlet hose with safety valve must only be replaced by your local Service Force Centre.
- Place the water inlet hose in such a way that it is never higher than the bottom edge of the safety valve.

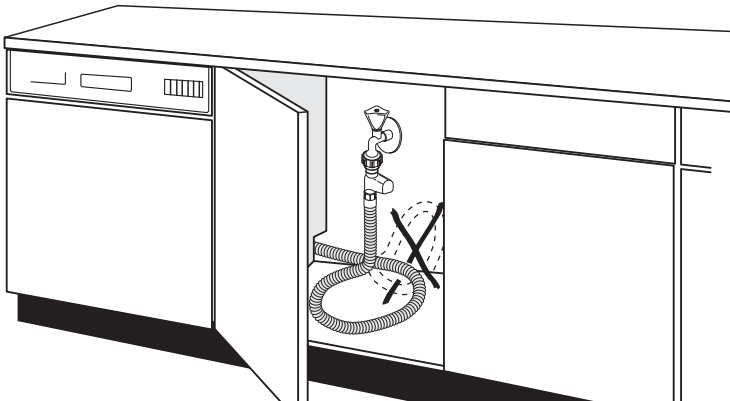
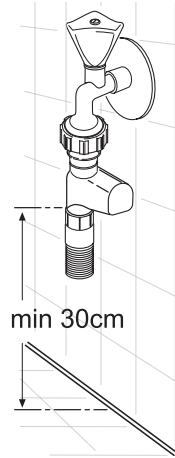

Water drain

Drain hose



The drain hose must not be kinked, crushed or entangled.

- Connecting the drain hose:
 - Maximum permitted height: 1 metre.
 - Minimum required height 40 cm above the lower edge of the machine.

Extension hoses

- Extension hoses are available from AEG Service Force. The internal diameter of the extension hoses must be 19 mm to ensure that the function of the appliance is not impeded.
- Hoses may be laid a maximum of 3 metres horizontally; the maximum permitted height for the connection for the drain hose is then 85 cm.

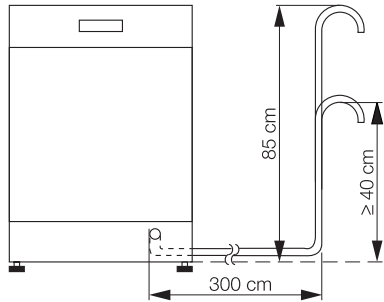

Sink outlet connection

- The outlet of the drain hose (\varnothing 19 mm) fits all commonly available sink outlet spigot types. The outer diameter of the spigot connection must be at least 15 mm.
- The drain hose must be fixed to the sink outlet connection using the hose clamp supplied.

If the dishwasher is fitted at a high position

If the dishwasher is installed at a high level, and the drain hose connection is less than 30 cm from the bottom of the appliance, adapter kit ET 111099520 must be fitted. This is available from Customer Service.

Discharging into a standpipe

When discharging into a standpipe, the upright standpipe should have a minimum length of 30 cm (12") from the bottom of the elbow to the top of the pipe (see diagram). Make sure that it is designed in such a way that the end of the drain hose cannot be covered with water.

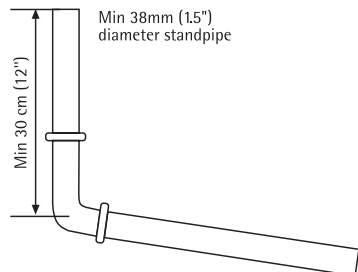

Leak prevention system

To avoid damage caused by water leakage, the dishwasher is equipped with a leak prevention system.

In the event of a fault, the safety valve in the appliance immediately interrupts the inflow of water and the drain pump is activated. In this way water can neither escape nor overflow. Any remaining water in the appliance is automatically pumped out.



The leak prevention system also works when the appliance is switched off – the appliance must however not be disconnected from the mains.

In the event of a fault when the appliance is switched on, a buzzing tone can also be heard.

Electrical Connection

Any electrical work required to install this appliance should be carried out by a qualified electrician or competent person.



WARNING – This appliance must be earthed. The manufacturer declines any responsibility should these safety measures not be observed.

Before switching on make sure the electricity supply voltage is the same as that indicated on the appliance rating plate.

To isolate the dishwasher from the mains, remove the mains plug.

Important: The plug must still be accessible after the appliance has been installed.

Changing a fuse

The appliance is supplied with a 13amp plug fitted. In the event of having to change the fuse in the plug supplied, a 13amp ASTA approved (BS 1363A) fuse must be used.

Should the plug need to be replaced for any reason, proceed as described below.

The wires on the mains lead are coloured in accordance with the following code.

Green and Yellow : Earth
Blue : Neutral
Brown : Live

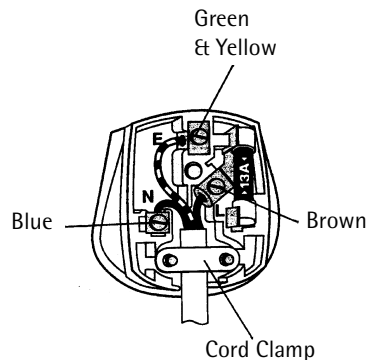

- The wire coloured green and yellow must be connected to the terminal marked with the letter "E" or by the earth symbol \oplus or coloured green and yellow.
- The wire coloured blue must be connected to the terminal "N" or coloured black.
- The wire coloured brown must be connected to the terminal marked "L" or coloured red.
- Upon completion there must be no cut, or stray strands of wire present and the cord clamp must be secure over the outer sheath.



WARNING! A cut off plug inserted into a 13 amp socket is a serious safety (shock) hazard. Ensure that, if it is necessary to cut off the plug, it is disposed of safely and not retained.

Connections

The water inlet and drain hoses, as well as the mains cable must be connected beside the dishwasher as there is insufficient space behind the appliance.

The plumbing and electrical installation example given below can only be regarded as a recommendation.

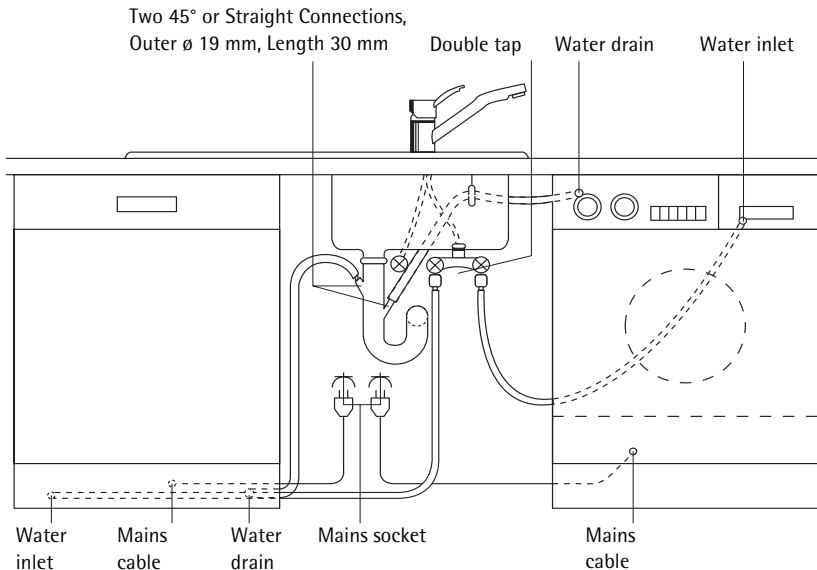

GUARANTEE CONDITIONS

Standard guarantee conditions

We, AEG, undertake that if within 12 months of the date of the purchase this AEG appliance or any part thereof is proved to be defective by reason only of faulty workmanship or materials, we will, at our discretion repair or replace the same FREE OF CHARGE for labour, materials or carriage on condition that:

- The appliance has been correctly installed and used only on the electricity or gas supply stated on the rating plate.
- The appliance has been used for normal domestic purposes only, and in accordance with the manufacturer's operating and maintenance instructions.
- The appliance has not been serviced, maintained, repaired, taken apart or tampered with by any person not authorised by us.
- All service work under this guarantee must be undertaken by a Service Force Centre. Any appliance or defective part replaced shall become the Company's property.
- This guarantee is in addition to your statutory and other legal rights.
- Home visits are made between 8.30am and 5.30pm Monday to Friday. Visits may be available outside these hours in which case a premium will be charged.

Exclusions

This guarantee does not cover:

- Damage or calls resulting from transportation, improper use or neglect, the replacement of any light bulbs or removable parts of glass or plastic.
- Costs incurred for calls to put right an appliance which is improperly installed or calls to appliances outside the United Kingdom.
- Appliances found to be in use within a commercial environment, plus those which are subject to rental agreements.
- Products of AEG manufacture which are not marketed by AEG.

European Guarantee

If you should move to another country within Europe then your guarantee moves with you to your new home subject to the following qualifications:

- The guarantee starts from the date you first purchased your product.
- The guarantee is for the same period and to the same extent for labour and parts as exists in the new country of use for this brand or range of products.
- This guarantee relates to you and cannot be transferred to another user.
- Your new home is within the European Community (EC) or European Free Trade Area.
- The product is installed and used in accordance with our instructions and is only used domestically, i.e. a normal household.
- The product is installed taking into account regulations in your new country.

Before you move please contact your nearest Customer Care centre, listed below, to give them details of your new home. They will then ensure that the local Service Organisation is aware of your move and able to look after you and your appliances..

France	Senlis	+33 (0) 3 44 62 29 29
Germany	Nürnberg	+49 (0) 800 234 7378
Italy	Pordenone	+39 (0) 800 117511
Sweden	Stockholm	+46 (0) 8 672 5360
UK	Slough	+44 (0) 1753 219899

SERVICE AND SPARE PARTS

In the event of your appliance requiring service, or if you wish to purchase spare parts, please contact Service Force by telephoning:

08705 929 929

Your telephone call will be automatically routed to the Service Force Centre covering your post code area.

For the address of your local Service Force Centre and further information about Service Force, please visit the website at www.serviceforce.co.uk

Before calling out an engineer, please ensure you have read the details under the heading „What to do if....“

When you contact the Service Force Centre you will need to give the following details:

1. Your name, address and post code.
2. Your telephone number
3. Clear and concise details of the fault.
4. The model and serial number of the appliance (found on the rating plate).

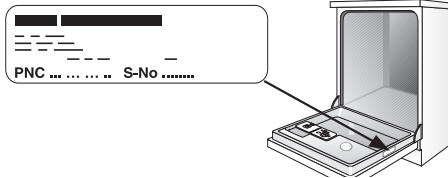

5. The purchase date

Please note that a valid purchase receipt or guarantee documentation is required for in-guarantee service calls.

Customer Care

For general enquiries concerning your AEG appliance or for further information on AEG products please contact our Customer Care Department by letter or telephone at the address below or visit our website at www.aeg.co.uk.

Customer Care Department
AEG Domestic Appliances
55-77 High Street
Slough
Berkshire, SL1 1DZ

Tel. 08705 350350 (*)

(*) Calls may be recorded for training purposes

 **From the Electrolux Group. The world's No. 1 choice.**

The Electrolux Group is the world's largest producer of powered appliances for kitchen, cleaning and outdoor use. More than 55 million Electrolux Group products (such as refrigerators, cookers, washing machines, vacuum cleaners, chain saws and lawn mowers) are sold each year to a value of approx. USD 14 billion in more than 150 countries around the world.

AEG Hausgeräte GmbH
Postfach 1036
D-90327 Nürnberg

<http://www.aeg.hausgeraete.de>

© Copyright by AEG

822 960 471 -00- 0203

Subject to change without notice