

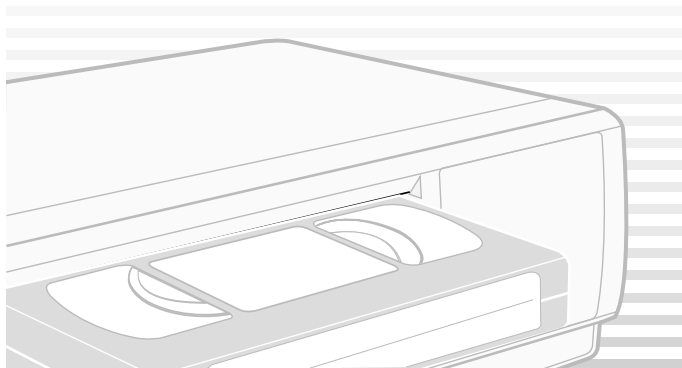

**VIDEO
CASSETTE RECORDER
SV-641B
SV-640B
SV-445B
SV-245B
SV-240B**

Instruction Manual



About this manual

Thank you for purchasing a Samsung Video Cassette Recorder (VCR). Your Owner's Instructions contain much valuable information on setting up and using your VCR. Please take the time to read them as they will help you take full advantage of your VCR's features.

The instructions in this manual are for models, SV-641B, SV-640B, SV-445B, SV-245B and SV-240B. Before you start reading this manual please check your model number. It is displayed on the rear of the VCR.

- ★(SV-641B): Exceptions only for a certain model, for example SV-641B.
- Gray shaded areas marked with a star indicate instructions that are only relevant to one model.

Features Chart

Feature	SV-641B	SV-640B	SV-445B	SV-245B	SV-240B
IPC (Intelligent Picture Control)	●	●	●	●	●
Changing recording speed (SP/LP)	●	●	●		
G-CODE recording		●		●	
Connecting an RCA Audio/Video cable		●		●	
Hi-Fi and A2	●	●			
Audio Dubbing		●			
Dual VCR/TV remote Control	●	●	●	●	

Contents

- ◆ FOREWORD
 - Safety Instructions..... 5
- ◆ VCR OVERVIEWS
 - Front View of the VCR 6
 - Rear View of the VCR 7
 - Infrared Remote Control..... 8
 - Display Indicator 9
 - Accessories 9
- ◆ CONNECTING YOUR VIDEO CASSETTE RECORDER
 - Deciding How to Connect Your VCR..... 10
 - Connecting Your VCR to the TV using the Coaxial Cable..... 11
 - Connecting Your VCR to the TV using the RCA Cable 11
 - Connecting Other Equipment to Your VCR..... 12
 - Plug & Auto Set Up..... 13
 - Tuning your Television for the VCR..... 14
- ◆ SETTING UP YOUR VIDEO CASSETTE RECORDER
 - Inserting Batteries in the Remote Control..... 15
 - Setting the Date and Time..... 15
 - Displaying/Hiding On-Screen Information 16
 - Choosing Your Language..... 16
 - Setting the VCR Output Channel..... 17
 - Presetting the Stations Automatically 18
 - Presetting the Stations Manually 19
 - Clearing a Preset Station..... 20
 - Changing the Preset Station Table..... 21
- ◆ RECORDING TELEVISION BROADCASTS
 - Selecting the Cassette Type..... 22
 - Selecting the Recording Speed (SV-641B/SV-640B/SV-445B Only)..... 22
 - Protecting a Recorded Cassette..... 23
 - Recording a Programme Immediately..... 23
 - Recording a Programme with Automatic Stop..... 24
 - Using the G-CODE Feature (SV-640B/SV-245B Only) 25
 - Modifying G-CODE Programming (SV-640B/SV-245B Only)..... 26
 - Using the Timer Programming Feature 27
 - Checking a Preset Recording..... 28
 - Cancelling a Preset Recording 28

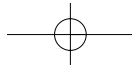

Contents (cont.)

GB

- ◆ PLAYING BACK
 - Playing a Cassette..... 29
 - Adjusting Picture Alignment Automatically (SV-240B Only)..... 29
 - Adjusting Picture Alignment Manually 29
 - Intelligent Picture Control 30
 - Intelligent Picture Control (SV-240B Only) 30
 - Selecting the Colour Mode 31
 - Selecting the Audio Output Mode (SV-641B/SV-640B Only) 32
 - Selecting the Audio Mute Mode (SV-445B/SV-245B/SV-240B Only)..... 32
- ◆ SEARCHING FOR A SEQUENCE
 - Playing a Cassette in Slow Motion 33
 - Playing a Sequence Frame by Frame 33
 - Picture Search, Fast Forward/Rewind..... 34
 - Searching for a Specific Sequence 34
 - Auto Repeat Play..... 35
 - Interval Repeat Play 35
- ◆ EASY OPERATION
 - G-CODE EXTEND (SV-640B/SV-245B Only) 36
 - Using the Tape Counter 36
- ◆ ADVANCED RECORDING FEATURES
 - Connecting RCA Audio/Video Input Cable (SV-640B/SV-245B Only) 37
 - Using the Assemble Edit Function..... 38
 - Recording from Another VCR or Camcorder..... 38
 - Audio Dubbing a Pre-recorded Cassette (SV-640B Only)..... 39
- ◆ OTHER FUNCTIONS AND USEFUL RECOMMENDATIONS
 - Using the TV Buttons on the Remote Control (SV-641B/SV-640B/SV-445B/SV-245B Only)..... 40
 - Auto Power Off 41
 - Child door lock system (SV-640B/SV-245B/SV-240B Only) 41
 - ECO Mode-Reducing Standby power consumption 41
 - Technical Specifications 42
- ◆ SOLVING PROBLEMS
 - Problems and Solutions..... 43
 - TV Frequency Table..... 44

Symbols



① = Step number

Safety Instructions

GB

The following illustrations represent precautions.



The lightning bolt is a warning sign alerting you to dangerous voltage inside the product. DO NOT OPEN THE VCR. Refer to service personnel.

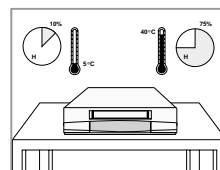

Do NOT expose the VCR to extreme temperature conditions (below 5°C and above 40°C) or to extreme humidity conditions (less than 10% and more than 75%).

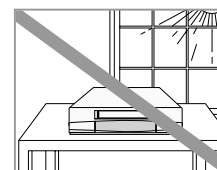

Do NOT expose the VCR to direct sunlight.

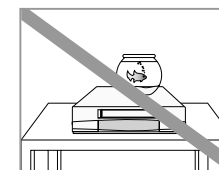

Do NOT expose the VCR to any liquids.

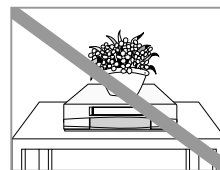

Do NOT place any objects on the VCR or remote control.



During a storm and/or lightning, unplug the VCR from the mains socket and aerial.

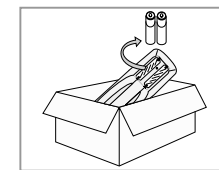

If the remote control is not used for a long period of time, remove the batteries and store it in a cool, dry place.

THIS DEVICE IS NOT FOR USE IN INDUSTRIAL ENVIRONMENTS

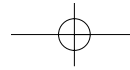

Front View of the VCR

Rear View of the VCR



(SV-641B)

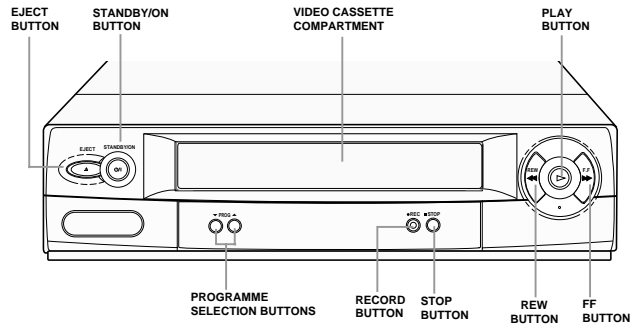

(SV-641B/SV-640B)

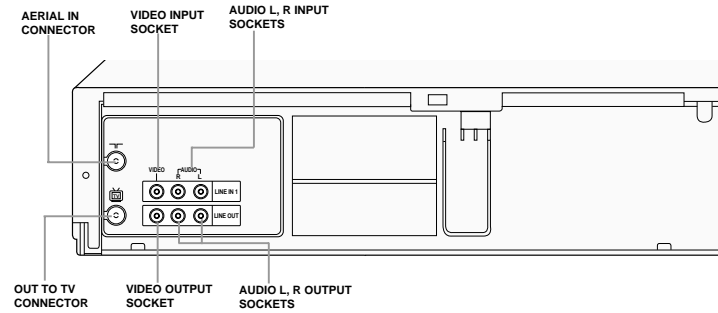

(SV-445B)

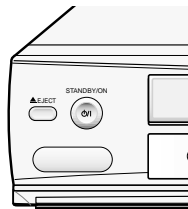

(SV-640B)

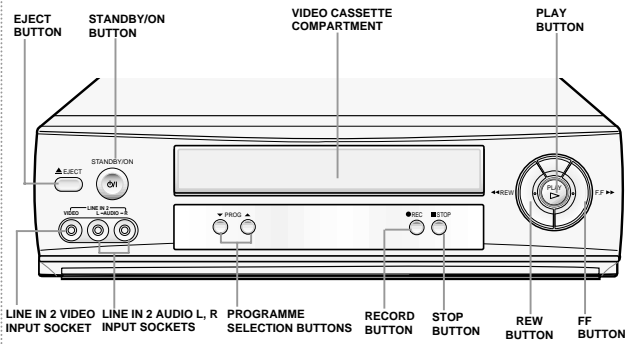

(SV-445B/SV-245B/SV-240B)

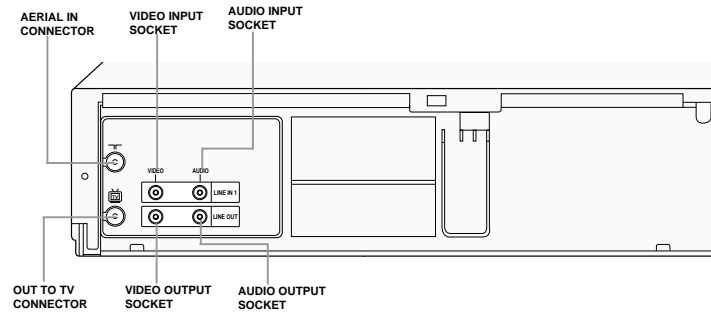

(SV-240B)

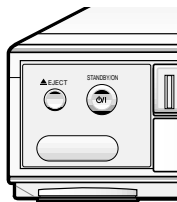

(SV-245B)

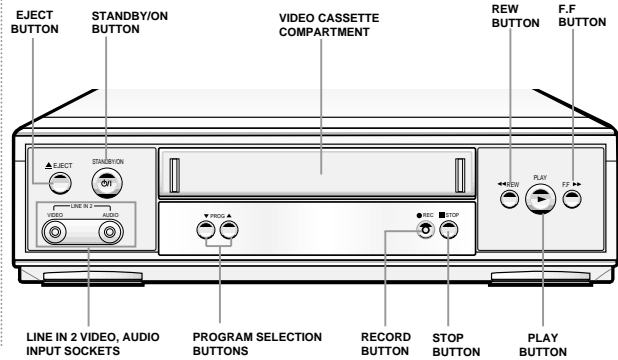

Infrared Remote Control

(SV-641B/SV-640B/SV-445B/SV-245B)

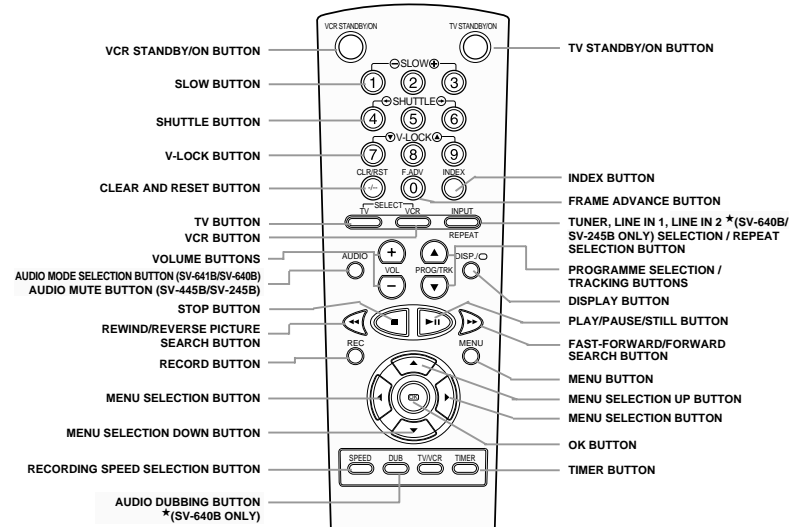

(SV-240B)

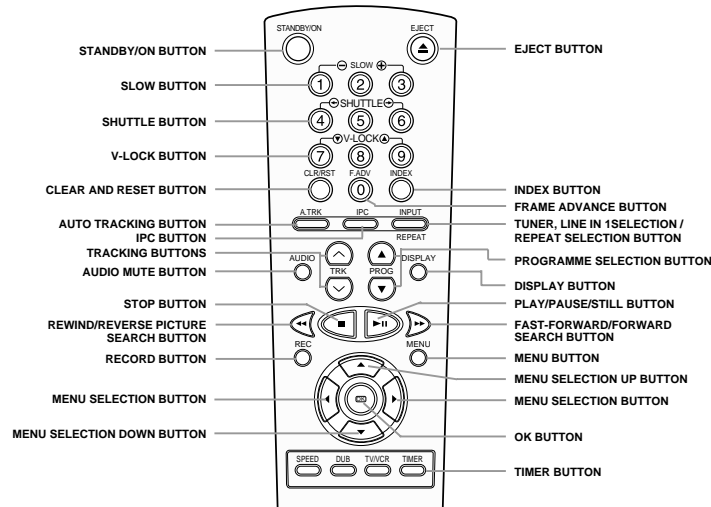

Display Indicator

SV-641B/SV-640B/SV-445B

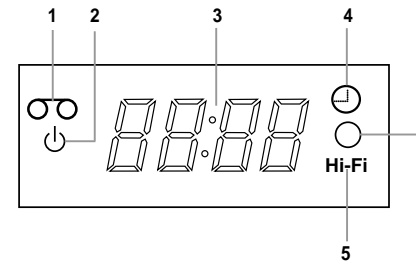

- 1 Cassette loaded indicator
 - 2 ECO Mode display
 - 3 Multi-function display
 - 4 Timer indicator
 - 5 Hi-Fi indicator
 - 6 REC indicator
- *(SV-641B/SV-640B Only)

SV-245B/SV-240B

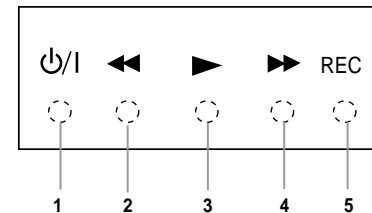

- 1 STANDBY/ON Mode display
- 2 Rewind indicator
- 3 Play indicator
- 4 FF indicator
- 5 Record indicator

◆ REFERENCE: The state of POWER in each power input conditions.

LED	MODE	UNPLUGGED	POWER OFF	POWER ON
THE STATE OF POWER LED		OFF	DIM GREEN	LIGHT GREEN

Accessories

You have just purchased a SAMSUNG Video Cassette Recorder (VCR). Together with your VCR, you will find the following accessories in the box.

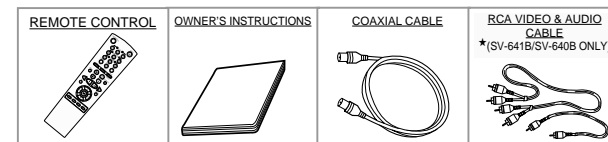

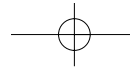

Deciding How to Connect Your VCR

GB

You must take into account various factors when connecting audio or video systems:

- ◆ Types of connectors available on your systems
- ◆ Systems connected permanently to the VCR (satellite receiver for example) or temporarily (camcorder for example)

Your VCR is equipped with the following connectors.

Connector	Location	Type	Direction	Recommended Use
LINE IN 1 ★(SV-640B only)	Rear 	Audio/Video RCA	In ⇐	◆ Camcorder ◆ Satellite receiver ◆ Other VCR
Audio/Video output ★(SV-641B/SV-640B only)	Rear 	Audio/Video RCA	Out ⇨	◆ Television ◆ Other VCR ◆ Audio Hi-Fi system
LINE IN 1	Rear 	Audio/Video RCA	In/Out ⇔	◆ Satellite receiver ◆ Television ◆ Other VCR
★(SV-445B/SV-245B/SV-240B only)				
LINE IN 2	Front 	Audio/Video RCA	In ⇐	◆ Audio Hi-Fi system ◆ Camcorder ◆ Other VCR
★(SV-640B only)				
LINE IN 2	Front 	Audio/Video RCA	In ⇐	◆ Audio system ◆ Camcorder ◆ Other VCR
★(SV-245B only)				
OUT TO TV	Rear 	75 Ω coaxial	Out ⇨	◆ Television
IN FROM ANT.	Rear 	75 Ω coaxial	In ⇐	◆ Aerial ◆ Cable television network ◆ Satellite receiver



Whenever you connect an audio or video system to your VCR, ensure that all elements are switched off.

Refer to the documentation supplied with your equipment for detailed connection instructions and associated safety precautions.

Connecting Your VCR to the TV using the Coaxial Cable

GB

To receive television programmes a signal must be received from one of the following sources:

- ◆ An outdoor aerial
- ◆ An indoor aerial
- ◆ A cable television network
- ◆ A satellite receiver



Make sure that both the television and the VCR are switched off before connecting the cables.

- 1 Remove the aerial or network input cable from the television.
- 2 Connect this cable to the 75Ω coaxial socket marked on the rear of your VCR.
- 3 Plug the coaxial cable supplied into the socket on your VCR.
- 4 Plug the other end of the coaxial cable into the connector previously used for the aerial on the television.
- 5 To obtain better quality pictures and sound on your television, you can also connect your VCR to the television via the RCA cable (see section below) if your television is equipped with this type of connection.

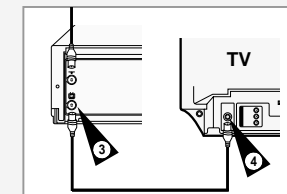
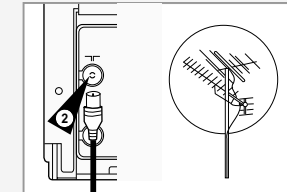

Connecting Your VCR to the TV using the RCA Cable

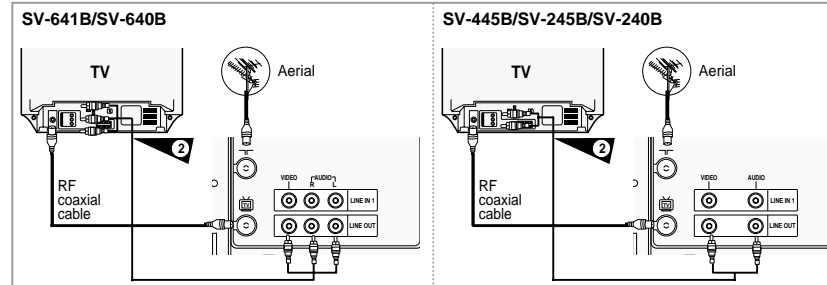

You can connect your VCR to the television using the RCA cable if the appropriate input is available on the television. You thus:

- ◆ Obtain better quality sound and pictures
- ◆ Simplify the setting up procedure of your VCR



- ◆ Regardless of the type of connection chosen, you must always connect the coaxial cable supplied. Otherwise, no picture will be visible on the screen when the VCR is switched off.
- ◆ Make sure that both the television and the VCR are switched off before connecting the cables.

- 1 Connect the coaxial cable as indicated in the above section.
- 2 Connect one end of the RCA Audio/Video cable to the Video output and Audio output socket on the rear of the VCR.
- 3 Plug the other end into the appropriate connector on the television.

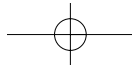

Connecting Other Equipment to Your VCR

GB

You can connect other audio and/or video equipment to your VCR in different ways. The following illustrations give a few examples of the connection possibilities.

- The RCA input/output connectors on the front of the VCR are used for equipment, such as camcorders, VCRs or sound systems.

SV-641B/SV-640B

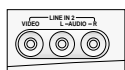

FRONT OF THE VCR
(SV-640B Only)

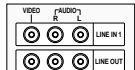

REAR OF THE VCR

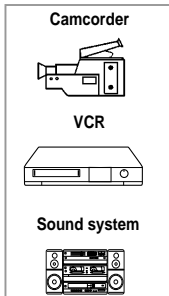
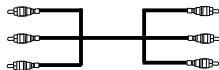

SV-445B/SV-245B/SV-240B

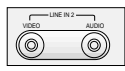

FRONT OF THE VCR
(SV-245B Only)

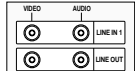

REAR OF THE VCR

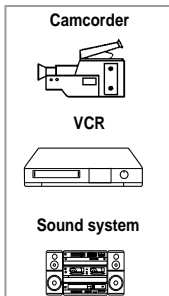
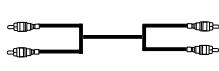

Plug & Auto Set Up

GB

Your VCR will automatically set itself up when it is plugged into the mains for the first time. TV stations will be stored in memory. The process takes a few minutes. Your VCR will then be ready for use.

- 1 Connect the coaxial cable as indicated on page 11. (Connecting Your VCR to the TV Using the Coaxial Cable)
- 2 Plug the VCR into the mains.
Result: The **LANGUAGE SET** menu is displayed.
- 3 Select the required language by pressing the **▲** or **▼** buttons.
- 4 Press OK to store the language selected.
Result: A message appears.
- 5 Press OK to start the auto scanning.
 - ◆ The number of stations automatically stored by the VCR depends on the number of stations that it has found.
- 6 On completion, press MENU twice to exit the menu.

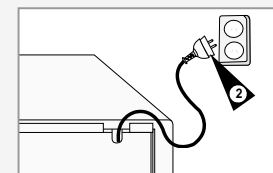
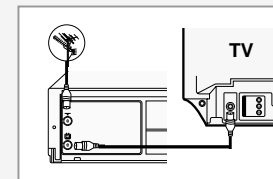

★(SV-640B/SV-445B)

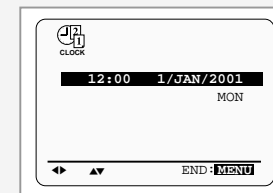
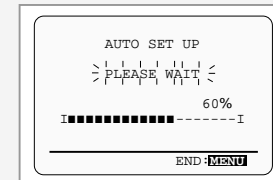
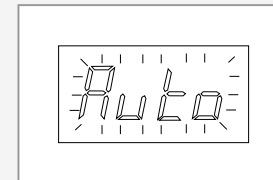

Tuning Your Television for the VCR

GB

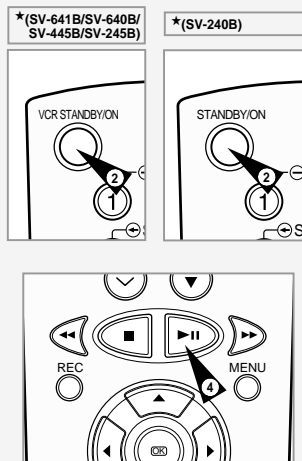

You must tune your television for the VCR only if you are not using a RCA cable

➤ To view pictures from your VCR when a RCA cable is used, the television must be set to the audio/video mode (AV).

- 1 Switch on the television.
- 2 Switch on the VCR by pressing STANDBY/ON on the front of the VCR or VCR STANDBY/ON (STANDBY/ON) on the remote control.
- 3 Select a programme position on the television to be reserved for use with your VCR.
- 4 Insert the video cassette in the VCR. Check that the VCR starts reading the cassette; if not, press ►|| button.
- 5 Start a scan on your television or set the television to UHF channel 38.
- 6 Fine tune the television until the pictures and sound are obtained clearly.
- 7 If you cannot find the pictures and sound, or there is interference from nearby channels, it may be necessary to change the setting of the VCR output channel (see Setting the VCR Output Channel on page 17 and Problems and Solutions on page 43).
- 8 When the picture and sound are perfectly clear, store this channel at the desired programme position on the television.
Result: That programme is now reserved for use with your VCR.

Inserting Batteries in the Remote Control

You must insert or replace the batteries in the remote control when you:

- ◆ Purchase the video cassette recorder
- ◆ Find that the remote control is no longer working correctly

- 1 Push the tab in the direction of the arrow to release the battery compartment cover on the rear of the remote control.
- 2 Insert two AA, R6 or equivalent batteries, taking care to respect the polarities:
 - ◆ + on the battery with + on the remote control
 - ◆ - on the battery with - on the remote control
- 3 Replace the cover by aligning it with the base of the remote control and pushing it back into place.

➤ Do not mix different battery types (manganese and alkaline for example).

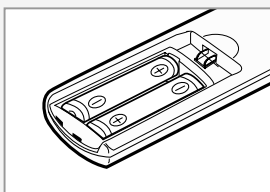
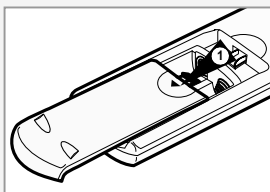

GB

Setting the Date and Time

Your VCR contains a 24-hour clock and calendar used to:

- ◆ Automatically stop programme recording
- ◆ Preset your VCR to record a programme automatically

You must set the date and time when:

- ◆ You purchase the video cassette recorder
- ◆ The power supply remains off for more than 1 hour
*(SV-641B/SV-640B only)
- ◆ The power supply remains off for more than 30 sec
*(SV-445B/SV-245B/SV-240B only)

◆ Do not forget to reset the time when you change clocks from winter to summer time and vice versa.

- 1 Press MENU on the remote control.
Result: The programming menu is displayed.
- 2 Press the corresponding ▲, ▼ or ◀, ▶ buttons to select the **CLOCK SET** option.
- 3 Press the OK button to select this option.
Result: The **CLOCK SET** menu is displayed.
- 4 Press ◀ or ▶ to select the hour, minutes, day, month and year.
Result: The option selected flashes.
- 5 Press the ▲ or ▼ buttons to increase or decrease the value.
Result: The day of the week is displayed automatically.
 - You can hold the ▲ or ▼ buttons down to scroll more quickly through the values.
- 6 On completion, press MENU twice to exit the menu.

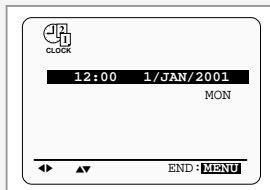
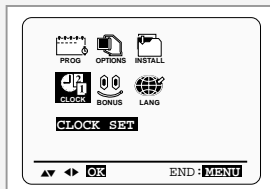
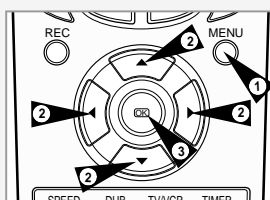

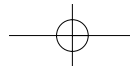

Displaying/Hiding On-Screen Information

GB

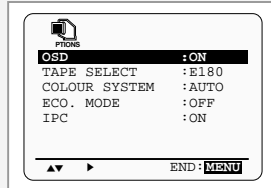
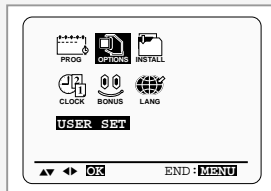

Your VCR displays most information both on the VCR and the television.

You can choose to display or hide this information on the television screen (except for the Index, Programming MENU and G-CODE ★ (SV-640B/SV-245B only) function, which cannot be hidden).

- Press MENU on the remote control.
Result: The programming menu is displayed.
- Press the corresponding ▲, ▼ or ◀, ▶ buttons to select the **USER SET** option.
- Press the OK button to select this option.
Result: The **USER SET** menu is displayed.
- Press the corresponding ▲ or ▼ buttons, until the OSD option is selected.
- To... Press ◀ or ▶, until...**

Display on-screen information	ON is displayed.
Hide on-screen information	OFF is displayed.
- On completion, press MENU twice to exit the menu.

Choosing Your Language

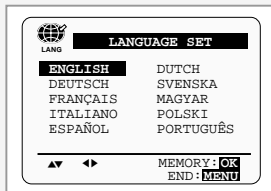
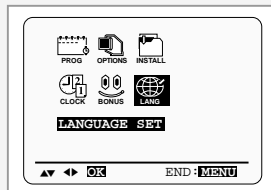

You can change the language in which information is displayed on the screen.

- Press MENU on the remote control.
Result: The programming menu is displayed.
- Press the corresponding ▲, ▼ or ◀, ▶ buttons to select the **LANGUAGE SET** option.
- Press the OK button to select this option.
Result: The **LANGUAGE SET** menu is displayed.
- Select the required language by pressing the ▲ or ▼ buttons.
- Press OK to store the language selected.
- Press MENU to exit the menu.
Result: From now on, all the on-screen information will be displayed in the language selected.

Setting the VCR Output Channel

GB

Your VCR output channel may need to be changed if the pictures suffer from interference or if your TV cannot find the pictures. Also, you can change the VCR output channel to adjust the frequency in which information is displayed on the screen.

- Press MENU on the remote control.
Result: The programming menu is displayed.
- Press the corresponding ▲, ▼ or ◀, ▶ buttons to select the **INSTALLATION** option.
- Press the OK button to select this option.
Result: The **INSTALLATION** menu is displayed.
- Press the corresponding ▲ or ▼ buttons, until the **VCR OUTPUT CH** option is selected.
- Select the required output channel by pressing the ◀ or ▶ buttons.
- On completion, press MENU twice to exit the menu. Then tune your television again (see page 14).

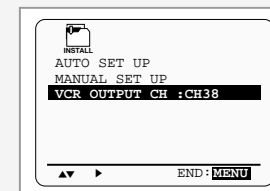
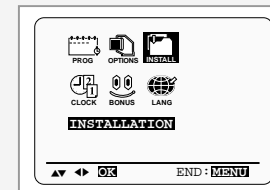

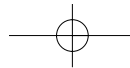

Presetting the Stations Automatically

GB

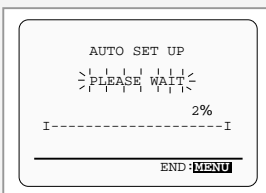
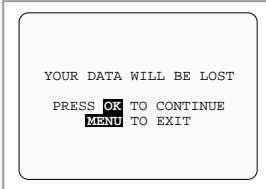
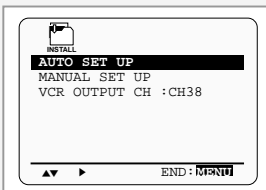
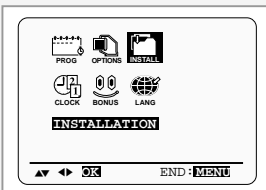

You do not need to preset the stations if you have already set them automatically (see Plug & Auto Set Up on page 13).

Your VCR contains a built-in tuner used to receive television broadcasts.

You must preset the stations received through the tuner. This can be done:

- ◆ Plug & Auto Set up (see page 13)
- ◆ Automatically
- ◆ Manually (see page 19)

You can store up to 80 stations.

- 1 Press the MENU button on the remote control.
Result: The programming menu is displayed.
- 2 Press the corresponding ▲, ▼ or ◀, ▶ buttons to select the **INSTALLATION** option.
- 3 Press the OK button to select this option.
Result: The **INSTALLATION** menu is displayed.
- 4 Press the corresponding ▲ or ▼ buttons, until the **AUTO SET UP** option is selected.
Press the ▶ button to select this option.
- 5 Press OK to start the auto scanning.
Result:
 - ◆ The **PLEASE WAIT** indication flashes on the television screen.
 - ◆ The first frequency band is scanned and the first station found is displayed and stored.
 - ◆ The VCR then searches for the second station and so on.
 - ◆ When the automatic scanning procedure has finished, the VCR switches automatically to programme 1.

➤ The number of stations automatically stored by the VCR depends on the number of stations that it has found.
- 6 If you wish to cancel the auto scanning before the end, press the MENU button three times to exit the menu.
 - ◆ Once the auto scanning procedure has finished, some stations may have been stored more than once; select the stations with the best reception and delete the ones no longer required (see page 20).

Presetting the Stations Manually

Your VCR contains a built-in tuner used to receive television broadcasts.

You must preset the stations received through the tuner. This can be done:

- ◆ Plug & Auto Set up (see page 13)
- ◆ Automatically (see page 18)
- ◆ Manually

You can store up to 80 stations.

You do not need to preset the stations manually if you have already set them automatically.

- 1 Press the MENU button on the remote control.
Result: The programming menu is displayed.
- 2 Press the corresponding ▲, ▼ or ◀, ▶ buttons to select the **INSTALLATION** option.
- 3 Press the OK button to select this option.
Result: The **INSTALLATION** menu is displayed.
- 4 Press the corresponding ▲ or ▼ buttons, until the **MANUAL SET UP** option is selected.
- 5 Press the ▶ button to select **MANUAL SET UP** option.
Result: The **TV STATION TABLE** menu is displayed.
- 6 Press the ▲ or ▼ buttons to select a programme number as required.
- 7 Press the ▶ button to preset the station.
Result: The **MANUAL TUNING** menu is displayed.
- 8 Press the ◀ or ▶ buttons to start scanning.
Result: The frequency band is scanned and the first station found is displayed.
If you know the number of the channel you want, press the numeric buttons on the remote control for example, for channel 06, first press "0" and then press "6". (see age 44)
- 9 Press the ▲ or ▼ buttons until the **NAME** is selected.
- 10 To change the programme's name, press the ▶ button.
Result: The first letter of the name flashes.
- 11

To...	Then...
Select a character in the name	Press the ▲ or ▼ button until the required character is displayed (letters, numbers or "-" character).
Move to the next or previous character	Press the ▶ or ◀ buttons respectively.
- 12

If you...	Then...
Wish to store the station displayed	<ul style="list-style-type: none"> ◆ Press the corresponding ▲ or ▼ buttons, until the MFT is selected. ◆ Press the ◀ or ▶ buttons to adjust the picture, if necessary. ◆ Press OK to store the station .
Do <u>not</u> wish to store the station displayed	<ul style="list-style-type: none"> ◆ Press the corresponding ▲ or ▼ buttons, until the CH is selected. ◆ Press the ◀ or ▶ buttons to go on scanning the frequency band and display the next station ◆ Go back to the beginning of Step 12
- 13 Repeat this procedure from Step 6 onwards, until all the required stations have been stored.
- 14 On completion, press the MENU button three times to exit the menu.

GB

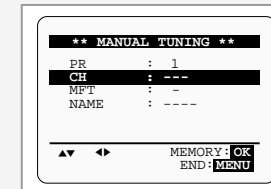
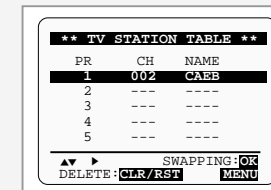
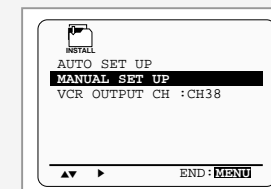
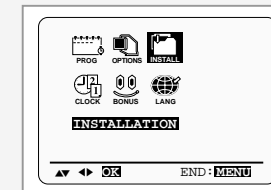

Clearing a Preset Station

GB

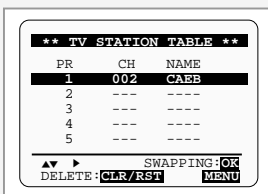
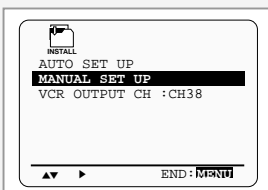
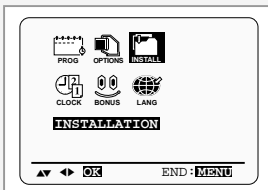

If you have stored a TV station:

◆ That you do not require

◆ At the wrong programme position

you can cancel it.

- 1 Press the MENU button on the remote control.
Result: The programming menu is displayed.
- 2 Press the corresponding ▲, ▼ or ◀, ▶ buttons to select the **INSTALLATION** option.
- 3 Press the OK button to select this option.
Result: The **INSTALLATION** menu is displayed.
- 4 Press the corresponding ▲ or ▼ buttons, until the **MANUAL SET UP** option is selected.
- 5 Press the ▶ button to select this option.
Result: The **TV STATION TABLE** menu is displayed.
- 6 Press the corresponding ▲ or ▼ buttons, until the required preset TV station (PR) is selected.
- 7 Press the CLR/RST button.
- 8 Repeat the same procedure from Step 6 onwards until all the required stations have been cleared.
- 9 On completion, press the MENU button three times to exit the menu.

Changing the Preset Station Table

GB

You can rearrange the preset TV stations according to your own preferences programme number assigned to the station.

- 1 Press the MENU button on the remote control.
Result: The programming menu is displayed.
- 2 Press the corresponding ▲, ▼ or ◀, ▶ buttons to select the **INSTALLATION** option.
- 3 Press the OK button to select this option.
Result: The **INSTALLATION** menu is displayed.
- 4 Press the corresponding ▲ or ▼ buttons, until the **MANUAL SET UP** option is selected. And then press the ▶ button to select this option.
Result: The **TV STATION TABLE** menu is displayed.
- 5 Press the corresponding ▲ or ▼ buttons, until the required preset TV programme is selected.
Result: The selected station is displayed at the same time on the television screen.
- 6 To change the programme number assigned to a station press the OK button on the remote control. (For example, To move a TV station in programme 1 to programme 3)
- 7 Press the ▲ or ▼ buttons to select required position. And then press OK again to swap the position.
- 8 You can modify this station by repeating the same procedure from Step 5 onwards.
- 9 On completion, press the MENU button three times to exit the menu.

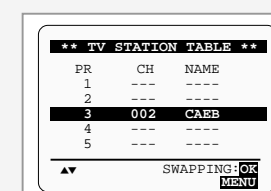
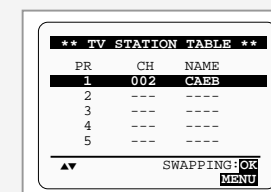
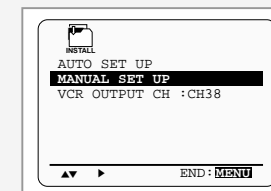
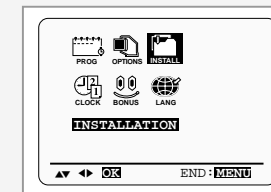

GB

Selecting the Cassette Type

If you wish to use the tape counter to display the time remaining on a cassette, you must indicate the type of cassette inserted.

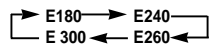
- Press MENU on the remote control.
Result: The programming menu is displayed.
- Press the corresponding ▲, ▼ or ◀, ▶ buttons to select the **USER SET** option.
- Press the OK button to select this option.
- Press the corresponding ▲ or ▼ buttons, until the **TAPE SELECT** option is selected.
- Press the ◀ or ▶ buttons as many times as required, until the correct cassette length is displayed.

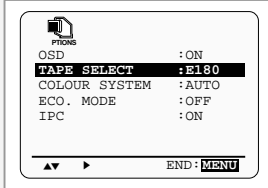
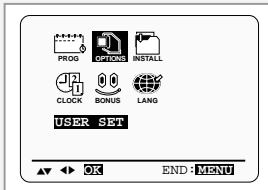
- Press MENU twice to exit the menu.

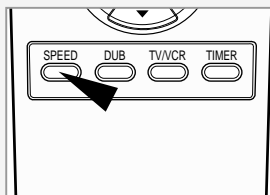

Selecting the Recording Speed ★(SV-641B/SV-640B/SV-445B Only)

Type	Recording Time (in SP)
E-180	180 mins. or 3 hours
E-240	240 mins. or 4 hours
E-260	260 mins. or 4 hours and 20 mins.
E-300	300 mins. or 5 hours



You can record a cassette at two different speeds:

- ◆ **SP (Standard Play)**
- ◆ **LP (Long Play)**

In Long Play modes:

- ◆ **Each cassette lasts twice as long**

To record a cassette... Press the **SPEED** button on the remote control, until...

In standard play mode SP is displayed.
In long play mode LP is displayed.

Protecting a Recorded Cassette

Video cassettes have a safety tab to prevent accidental erasure. When this tab has been removed, you **cannot** record on the tape.

- If you wish to protect a cassette, break off the tab using a small screwdriver.
- To re-record over a protected cassette (safety tab broken), cover the hole with adhesive tape.

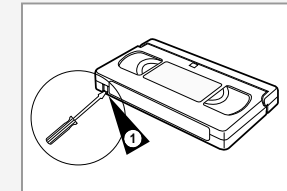

Recording a Programme Immediately

Before recording a programme, you must have preset the corresponding station (unless you are recording via an external video source). If you have not done so, refer to pages 18 and 19.

- Switch on the television.
- To monitor the programme being recorded, select the television channel reserved for use with your VCR (or the AV input if used).
- Insert the cassette on which the programme is to be recorded, with the window visible and the safety tab intact or the opening covered with adhesive tape.
Result: The VCR is switched on automatically.
- Select:
 - ◆ The station to be recorded using the PROG/TRK (▲ or ▼) / PROG (▲ or ▼) buttons
 - or
 - ◆ The LINE IN 1 or LINE IN 2 ★(SV-640B/SV-245B only) source using the INPUT button for a satellite tuner or external video source**Result:** The station number is displayed and the programme can be seen on the television.
- ★ With SV-641B/SV-640B/SV-445B, you can select the recording speed (SP/LP). Press the SPEED button.

- Hold REC down for a while to start recording.
Result: The record indicator appears on the television and VCR display. An index is recorded on the tape (see page 34).
- To stop recording, press ■ once.

- ◆ If the cassette is ejected when you start recording, check that the safety tab is intact or the opening is covered with adhesive tape.
- ◆ If you reach the end of the tape while recording, the cassette rewinds automatically.

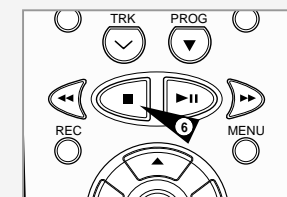
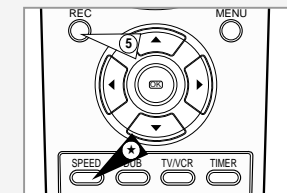
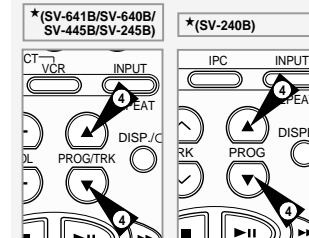

Recording a Programme with Automatic Stop

GB

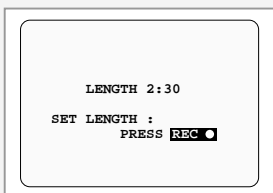
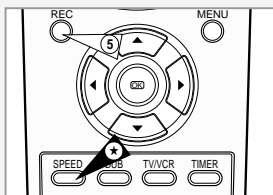
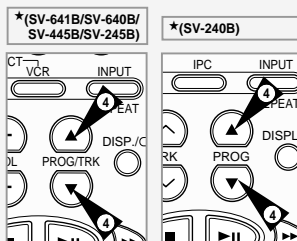
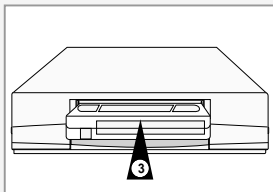

This function enables you to record up to nine hours of programmes. (LP)

Your VCR stops automatically after the requested length of time.

- 1 Switch on the television.
- 2 To monitor the programme being recorded, select the television channel reserved for use with your VCR (or the AV input if used)
- 3 Insert the cassette on which the programme is to be recorded, with the window visible and the safety tab intact or the opening covered with adhesive tape.
Result: The VCR is switched on automatically.
- 4 Select:
 - ◆ The station to be recorded using the PROG/TRK (▲ or ▼) / PROG (▲ or ▼) buttons
 - OR
 - ◆ The LINE IN 1 or LINE IN 2 *(SV-640B/SV-245B only) source using the INPUT button for a satellite tuner or external video source**Result:** The channel number is displayed and the programme can be seen on the television.
- ★ With SV-641B/SV-640B/SV-445B, you can select the recording speed (SP/LP). Press the SPEED button.
- 5 Hold the REC button down for a while to start recording.
Result: The record indicator appears on the television screen and VCR display. An index is recorded on the tape (see page 34).
- 6 Press the REC button several times to increase the recording time in:
 - ◆ 30-minute intervals up to four hours
 - ◆ 1-hour intervals up to nine hours (LP)**Result:** The length is displayed on the television displays. The selected programme is recorded for the length of time requested. At the end of that time, the VCR stops recording automatically.
- 7 If you wish to cancel the recording before the end, press VCR STANDBY/ON (STANDBY/ON).



If the end of the tape is reached while recording:

- ◆ The recording stops
- ◆ The VCR automatically turns off

Using the G-CODE Feature ★(SV-640B/SV-245B Only)

Before presetting your VCR:

- ◆ Switch on both the television and your VCR
- ◆ Check that the date and time are correct
- ◆ Insert the cassette on which the programme is to be recorded (safety tab intact)

Up to six programmes can be preset.

- 1 Press the **TIMER** button.
Result: The **TIMER METHOD** is displayed.
- 2 Press the corresponding **▲** or **▼** buttons, until the **G-CODE** option is selected.
- 3 Press the **▶** button to select **G-CODE**.
Result: A message is displayed to allow you to enter the G-CODE code.
 - ☞ If all six programmes have been set, the message **TIMER IS FULL** is displayed. Refer to page 28 if you wish to cancel a preset recording.
- 4 Press the numeric buttons to enter the code opposite the programme that you wish to record in your television magazine.
 - If you wish to correct the G-CODE code that you are entering:
 - ◆ Press the **◀** button until the digit to be corrected is cleared
 - ◆ Enter the correct digit
- 5 Press the **MENU** button.
Result: The information concerning the programme is displayed.
 - ☞ When using the G-CODE function for the first time with stored stations, the programme number flashes. This one time, you must enter the station number manually by pressing the **▲** or **▼** buttons. Refer to the following page if:
 - ◆ The programme number or times flash
 - ◆ You wish to modify the programme
- 6 If the programme and times are correct, press the **MENU** button.
- 7 Press the **VCR STANDBY/ON (STANDBY/ON)** button to activate the timer.
Result: The Timer indicator (⏰) is displayed. (SV-640B)
The REC indicator dim the light. (SV-245B)
 - ☞ If no cassette has been inserted when you press **VCR STANDBY/ON (STANDBY/ON)** the Timer indicator flashes. If the safety tab on the cassette has been broken, the cassette is ejected. Insert the appropriate cassette.
- 8 Refer to page 28 if you wish to:
 - ◆ Check that your VCR has been programmed correctly
 - ◆ Cancel a preset recording

☞ The numbers next to each TV programme listing are G-CODE code numbers, which allow you to programme your videorecorder instantly with the remote control. Tap in the G-CODE code for the programme you wish to record.

GB

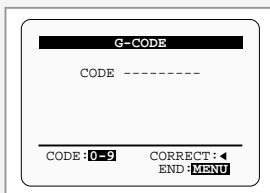
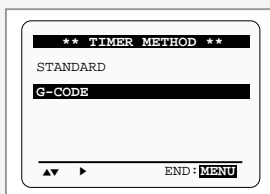
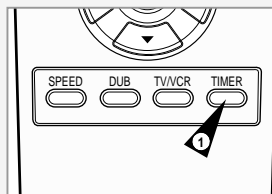

★(SV-640B)

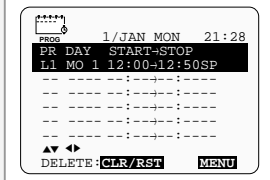

★(SV-245B)

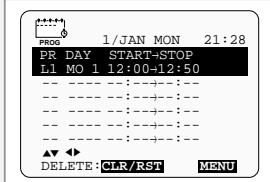

™ G-CODE is a trademark of Gemstar Development Corporation. The G-CODE system is manufactured under licence from Gemstar Development Corporation.

Modifying G-CODE Programming ★(SV-640B/SV-245B Only)

If you wish to correct the programme displayed or modify certain elements, such as the recording speed, you can do so before you press MENU a second time to confirm.

If you wish to...	Then...
Select an input source other than the tuner LINE IN 1 or LINE IN 2 input	<ul style="list-style-type: none"> ◆ Press the ◀ or ▶ buttons, until the PR selection flashes. ◆ Press the INPUT button one or more times to change the input source selection. ➤ The input source must be selected before changing any other value.
Record a programme every day (Monday to Sunday) at the same time	<ul style="list-style-type: none"> ◆ Press the ◀ or ▶ buttons, until the DAY selection flashes. ◆ Press the ▲ or ▼ buttons, until the DLY (Daily) value is displayed.
Record a programme every week on the same day and at the same time	<ul style="list-style-type: none"> ◆ Press the ◀ or ▶ buttons, until the DAY selection flashes. ◆ Press the ▲ or ▼ buttons, until the W- (Week) value is displayed, followed by the required day. Example: W-SA (Weekly Saturday)
Extend the recording time	<ul style="list-style-type: none"> ◆ Press the ◀ or ▶ buttons, until the STOP selection flashes. ◆ Press the ▲ or ▼ buttons to increase or decrease the stop time.
Select the recording speed ★(SV-640B only)	<ul style="list-style-type: none"> ◆ Press the ◀ or ▶ buttons, until the recording speed selection flashes. ◆ Press the ▲ or ▼ buttons until the correct indication is displayed: <ul style="list-style-type: none"> • AUTO (Auto Tape Speed Select) : see page 27 • SP (Standard Play) • LP (Long Play)

Using the Timer Programming Feature

The Timer Programming feature allows you to preset the VCR to record a programme up to one month before that programme is to be broadcast. Up to six programmes can be preset.

✎ Before presetting a recording, check that the date and time are correct.

- 1 - Insert the cassette. Press the TIMER button.
Press the ▲ or ▼ buttons to select the STANDARD option and then press the ▶ button or,
◆ Press MENU on the remote control.
Result: The programming menu is displayed.
◆ Press the OK button to select TIMER PROGRAMMING option.
Result: The TIMER PROGRAMMING menu is displayed.
 - 2 Press ▶ to select the input source.
 - 3 Select the required station by pressing the ▲, ▼ buttons or INPUT to select the LINE IN 1 or LINE IN 2 ★(SV-640B/SV-245B only) input sources.
 - 4 Press ▶ to select the recording day.
 - 5 Select the required day by pressing the ▲ or ▼ buttons.
 - 6 Press ▶ to select the recording start time.
 - 7 Select the required hour value by pressing the ▲ or ▼ buttons.
 - 8 Press ▶ to select the minutes.
 - 9 Select the required minute value by pressing the ▲ or ▼ buttons.
 - 10 Press ▶ to select the recording end time.
 - 11 Select the required recording end time by pressing the ▲ or ▼ buttons, following the same procedure as when selecting the recording start time.
- ★ With SV-641B/SV-640B/SV-445B, you can select the recording speed.
a. Press ▶ to select the the recording speed (AUTO/SP/LP).
b. Press the ▲ or ▼ buttons to switch between the AUTO, SP (Standard Play) or LP (Long Play).
- 12 When you have finished, press the MENU button.
 - 13 Press the VCR STANDBY/ON (STANDBY/ON) button to activate the timer.
Result: Before starting recording, the VCR compares the timer duration with the remaining time on the cassette.

✎ Auto Tape Speed Select ★(SV-641B/SV-640B/SV-445B only)

The VCR's "Auto Tape Speed Select" function compares the duration of the timer recording to the actual recording time remaining on the tape loaded. If there is insufficient tape to complete a timer recording in AUTO mode, the VCR automatically switches to LP mode to record the whole programme.

E.g. If there is a one hour AUTO mode timer recording to be started, but only 40 minutes of tape remaining, the VCR will record in SP for 20 minutes and switch to LP mode for the remaining 40 minutes.

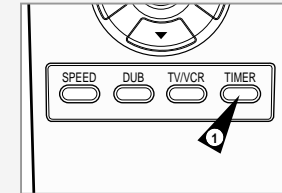

★(SV-640B/SV-245B)

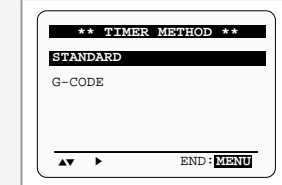

★(SV-641B/SV-640B/SV-445B)

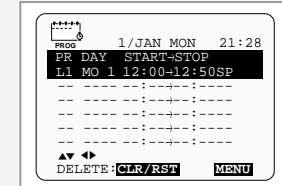

★(SV-245B/SV-240B)

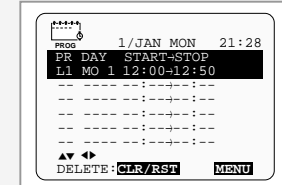

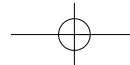

Checking a Preset Recording

GB

★(SV-641B/SV-640B/SV-445B)

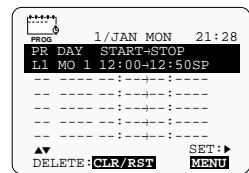

★(SV-245B/SV-240B)

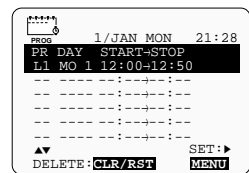

You can check your preset recordings:

- ◆ When you have finished presetting the VCR
- ◆ If you have forgotten which programmes will be recorded

- 1 - Insert the cassette. Press the TIMER button. Press the ▲ or ▼ buttons to select the **STANDARD** option and then press the ► button or,
 - ◆ Press MENU on the remote control.
 - Result: The programming menu is displayed.
 - ◆ Press the OK button to select **TIMER PROGRAMMING** option.
 - Result: The **TIMER PROGRAMMING** menu is displayed.
- 2 Press the ▲ or ▼ buttons to select the required programme.
- 3 Press the ◀ or ▶ buttons to select and change any values as required. For more details, refer to the previous page.
- 4 On completion, press MENU twice.

Cancelling a Preset Recording

★(SV-641B/SV-640B/SV-445B)

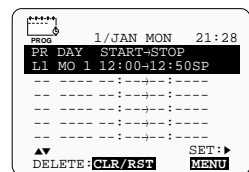

★(SV-245B/SV-240B)

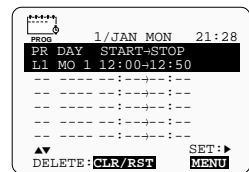

You can cancel any programmes that are:

- ◆ Incorrect
- ◆ No longer required

- 1 - Insert the cassette. Press the TIMER button. Press the ▲ or ▼ buttons to select the **STANDARD** option and then press the ► button or,
 - ◆ Press MENU on the remote control.
 - Result: The programming menu is displayed.
 - ◆ Press the OK button to select **TIMER PROGRAMMING** option.
 - Result: The **TIMER PROGRAMMING** menu is displayed.
- 2 Select the programme to be cancelled by pressing the ▲ or ▼ buttons.
- 3 Press the CLR/RST button to cancel the selected programme.
 - Result: All the recording information is deleted and the broadcast will not be recorded.
- 4 On completion, press MENU twice.

Playing a Cassette

GB

This function allows you to play back any pre-recorded cassette.

- 1 Switch on both the television and your VCR.
- 2 Insert the video cassette to be played. If the safety tab on the cassette is intact, press ►II. Otherwise, the cassette is played automatically.
 - When a cassette is loaded, the tape position is optimized automatically to reduce disturbance (Digital Auto Tracking). When playing a cassette, if the end of the tape is reached, the cassette is rewound automatically. NTSC tapes can be played back but cannot be recorded with this VCR.
- 3 To... Then press...

Stop the playback	■ (STOP).
Eject the cassette	▲ (EJECT).

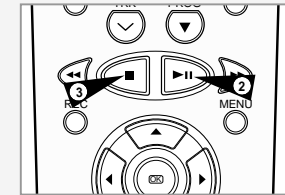

Adjusting Picture Alignment Automatically ★(SV-240B Only)

The **Picture Alignment** feature enables you to optimize the tape position automatically to obtain the best possible picture.

When noise bars or streaks appear during playback, adjust picture alignment by pressing the A.TRK button.

- Result:
- ◆ The tracking bar appears.
 - ◆ The picture is automatically adjusted.
 - ◆ The tracking bar disappears when digital auto tracking has been completed.

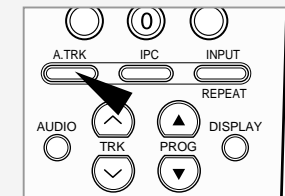

Adjusting Picture Alignment Manually

The **Picture Alignment** feature allows you to adjust the alignment manually to obtain the best possible picture.

When noise bars or streaks appear during playback, adjust alignment manually by pressing the PROG/TRK (▲ or ▼) / TRK (▲ or ▼) buttons until the picture is clear and stable.

- Result:
- ◆ The tracking bar appears.
 - ◆ The image is adjusted.
 - ◆ The tracking bar disappears when you release the button.

★(SV-641B/SV-640B/SV-445B/SV-245B)

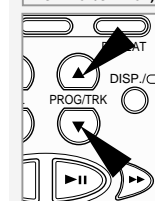

★(SV-240B)

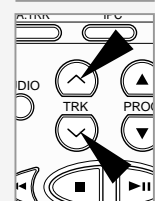

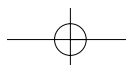

Intelligent Picture Control

GB

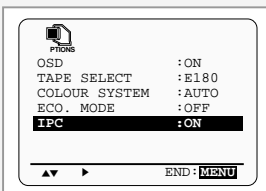
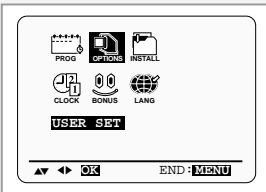

The **Intelligent Picture Control Feature** allows you to adjust the sharpness of the image automatically, according to your own preferences.

- 1 During playback, press the MENU button on the remote control.
Result: The programming menu is displayed.
- 2 Press the corresponding ▲, ▼ or ◀, ▶ buttons to select the **USER SET** option.
- 3 Press the OK button to select this option.
Result: The **USER SET** menu is displayed.
- 4 Press the corresponding ▲ or ▼ buttons, until the **IPC** option is selected.
- 5 Press the ▶ button to select the **IPC** (intelligent picture control) option.
 - When intelligent picture control mode is **ON**, the sharpness of the image is adjusted automatically.
- 6 To adjust the sharpness manually, press the ▼ button to turn the **IPC** mode **OFF**.
- 7 Press the ◀ or ▶ buttons until the picture is displayed according to your preferences.
 - If you do not press a button within ten seconds, the **PICTURE** menu disappears automatically.
- 8 On completion, press the MENU button again.

Intelligent Picture Control ★(SV-240B Only)

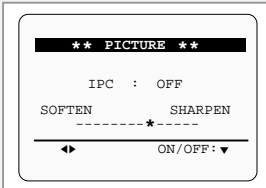
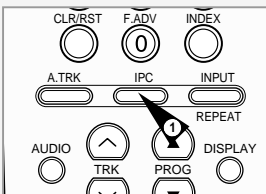

The **Intelligent Picture Control Feature** allows you to adjust the sharpness of the image automatically, according to your own preferences.

- 1 During playback, press the **IPC** button on the remote control.
- 2 Press the ▼ button to turn the **IPC** (intelligent picture control) option **ON** and **OFF**.
 - When intelligent picture control mode is **ON**, the sharpness of the image is adjusted automatically.
- 3 To adjust the sharpness manually, select intelligent picture control mode **OFF**.
 - ◆ The horizontal picture adjusting appears.
- 4 Press the ◀ or ▶ buttons until the picture is displayed according to your preferences.
 - If you do not press a button within ten seconds, the **PICTURE** menu disappears automatically.
- 5 On completion, press the **IPC** button again.

Selecting the Colour Mode

GB

Before recording or playing back a cassette, you can select the required system standard.

- ◆ When you playback an NTSC-recorded tape on this VCR make a setting on the colour system according to your TV. If your TV is a PAL system only TV, set NTPB. If your TV is Multi System TV (NTSC 4.43 compatible), set NT4.43 and you can record NT4.43.

- 1 Press MENU on the remote control.
Result: The programming menu is displayed.
- 2 Press the corresponding ▲, ▼ or ◀, ▶ buttons to select the **USER SET** option.
- 3 Press the OK button to select this option.
Result: The **USER SET** menu is displayed.
- 4 Press the corresponding ▲ or ▼ buttons, until the **COLOUR SYSTEM** option is selected.
- 5 Press the ▶ button to select **AUTO** → **PAL** → **MESECAM** → **B/W**.

AUTO	When playing back a cassette, the PAL/NTSC system standard is automatically selected by the VCR.
B/W	Black and White
- 6 On completion, press MENU twice to exit the menu.

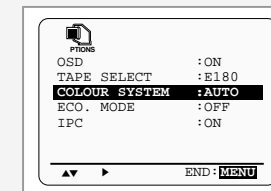
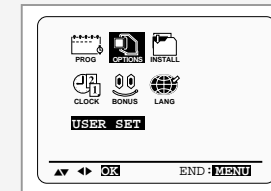

AUTO	When playing back a cassette, the PAL/NTSC system standard is automatically selected by the VCR.
B/W	Black and White

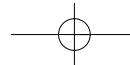

Selecting the Audio Output Mode ★(SV-641B/SV-640B Only)

GB

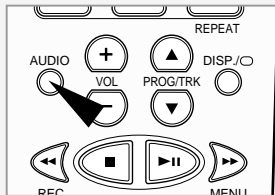

When monitoring a TV programme or playing back a Hi-Fi recorded video tape, press the **AUDIO** button to select a desired sound output. As the **AUDIO** button is pressed, the sound output and the indicator change as below:

Sound type OSD display	Stereo sound	Bilingual sound	Standard sound broadcast
	Heard in stereo. (left channel and right channel)	Channel I (MAIN) heard from the left speaker, channel II (SUB) heard from the right speaker.	Heard in monaural.
	Left channel heard from both the left and right speakers.	Channel I (MAIN) heard from both the left and the right speakers.	Heard in monaural.
	Right channel heard from both the left and right speakers.	Channel II-(SUB) heard from both the left and the right speakers.	Heard in monaural.
MIX	Sound mixed the left and right channels, and the normal audio track.		
MONO	Heard in monaural.	Channel I (MAIN) heard from both the left and the right speakers.	Heard in monaural.

Selecting the Audio Mute Mode ★(SV-445B/SV-245B/ SV-240B Only)

★(SV-445B/SV-245B)

★(SV-240B)

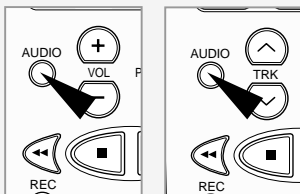

You can select the mode in which the sound is mute.

To select the audio mute mode on and off, simply press the **AUDIO** button on the remote control.

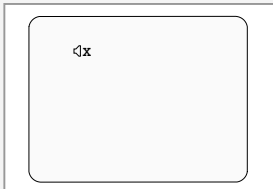

Playing a Cassette in Slow Motion

GB

You can play a cassette in slow motion.

➤ No sound is heard when playing back a cassette in slow motion.

- Press:
 - ▶▶ to start playing the cassette
 - SLOW () as many times as required to decrease or increase the speed respectively

☞ To return to the normal speed, press the ▶▶ button twice.

- When playing back in slow motion, picture interference may occur. Press the **PROG/TRK** (▲ or ▼) / **TRK** (⤴ or ⤵) buttons to minimize this effect.

☞ When you have been using the Slow Motion function for more than about five minutes, the VCR will automatically play to protect the:

- ◆ Cassette
- ◆ Video heads

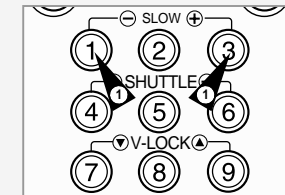

★(SV-641B/SV-640B/ SV-445B/SV-245B)

★(SV-240B)

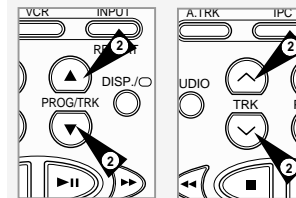

Playing a Sequence Frame by Frame

You can:

- ◆ Stop the cassette at a given frame (image)
- ◆ Advance one frame at a time

➤ No sound is heard when playing back frame by frame.

- Press:
 - ▶▶ to start playing the cassette
 - ▶▶ to stop the tape at a given frame
 - F.ADV () to advance frame by frame

- To return to normal playback, press ▶▶.

☞ When you have been using the Frame-by-Frame function for more than about five minutes, the VCR will automatically play to protect the cassette and video heads.

➤ Vertical stability: When playing back frame by frame, interference may be seen on the screen. Press the **V-LOCK** () buttons to minimize this effect.

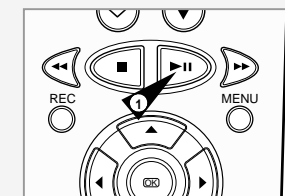

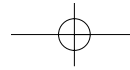

Picture Search, Fast Forward/Rewind

GB

Picture Search enables you to Fast Forward or Rewind and look for a particular part of a tape.

- 1 Press PLAY, the VCR will enter normal play mode. While in play, press and release the ►► (or ◀◀) button. The VCR will search at 5 times the normal playback speed.
- 2 To return to normal playback mode, press the ►|| button.
- 3 If you press and HOLD down the ►► (or ◀◀) button the VCR will search at 9 times the normal speed. Releasing the ►► button will return the VCR to search at 5 times the normal speed. To return to normal playback mode, press the ►|| button.
- 4 Whilst in Picture Search mode, if you press the ►► button again, the VCR will enter normal Fast Forward mode.
- 5 Likewise, whilst in Picture Search ◀◀ mode, if you press the ◀◀ button again, the VCR will enter normal Rewind mode.
- 6 If, when Redwing (◀◀) or Fast Forwarding (►►), you press the ◀◀ (or ►►) button, the VCR will enter the Picture Search mode.

Searching for a Specific Sequence

Each time you record a cassette on this VCR, an "index" is automatically marked on the tape when recording starts.

The Search function allows you to fast-forward or rewind to a specific index and start playback from that point. Depending on the direction selected, the indexes are numbered as follows:

↓				
etc.	Prev Seq.	Seq. being played	Next Seq.	etc.
	2	1	1	2

➤ This VCR uses a standard indexing system (VISS). As a result, it will recognize any indexes marked by other VCRs using the same system and vice versa.

INTRO SCAN

- 1 To search for a specific index, press INDEX.
- 2 Press the ◀◀ or ►► buttons depending on the direction where your desired programme is located.
- 3 When an Index mark is found the VCR will playback the tape for 5 seconds, after which it will continue searching for the next Index mark.
- 4 If you want to watch the tape from a particular Index, simply press ►||.

Index Skip Search:

This feature will enable you to fast forward/rewind to a specific point on a tape: E.g. if you have recorded 3 different programmes on a tape and you have rewound the tape to the beginning, by using this feature you can go directly to the start of programme 2 simply by pressing the INDEX button.

- 1 Press the INDEX to start the Index search.
- 2 Press the ◀◀ or ►► buttons twice more. This will take you directly to the start of the desired programme is located.
- 3 These Index searches can be made forwards: (press ►►) or backwards: (press ◀◀).
- 4 To cancel an Index search simply press the ►|| or ■ button.

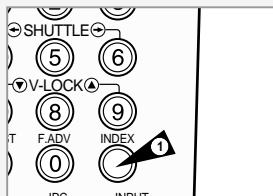

INDEX: ◀◀ ►►

INDEX SEARCH: ►► +01

Auto Repeat Play

You can set repeat play to repeat the tape continuously from beginning to end.

- 1 Press MENU on the remote control.
Result: The programming menu is displayed.
- 2 Press the corresponding ▲, ▼ or ◀, ► buttons to select the **EASY OPERATION** option.
- 3 Press the OK button to select this option.
Result: The **EASY OPERATION** menu is displayed.
- 4 Press the corresponding ▲ or ▼ buttons, until the **REPEAT PLAY** option is selected.
- 5 To... **Press ◀ or ►, until...**
Repeat play **ON** is displayed.
Do not wish to repeat play **OFF** is displayed.
- 6 On completion, press MENU twice to exit the menu.

★(SV-640B/SV-245B)

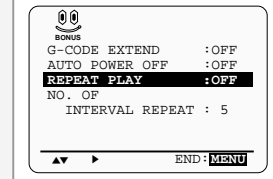

★(SV-641B/SV-445B/SV-240B)

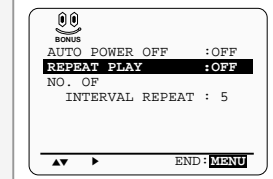

Interval Repeat Play

You can set interval repeat play to repeat the cassette several times for special interval.

- 1 Press MENU on the remote control.
Result: The programming menu is displayed.
- 2 Press the corresponding ▲, ▼ or ◀, ► buttons to select the **EASY OPERATION** option.
- 3 Press the OK button to select this option.
Result: The **EASY OPERATION** menu is displayed.
- 4 Press the corresponding ▲ or ▼ buttons, until the **NO. OF INTERVAL REPEAT** option is selected.
- 5 To... **Press ►, until...**
Interval repeat play 5, 10, 15 is displayed.
(choose repeat time 5 times, 10 times, 15 times)
Cancel interval repeat play **OFF** is displayed.
- 6 On completion, press MENU twice to exit the menu.
- 7 To select interval during playback, press the INPUT/REPEAT button at the desired start point.
Result: "**INTERVAL REPEAT SETTING**" is displayed.
Press the INPUT/REPEAT button one more time at the desired end point.
Result: The tape is automatically rewound to the start point. "**INTERVAL REPEAT**" is displayed.

★(SV-640B/SV-245B)

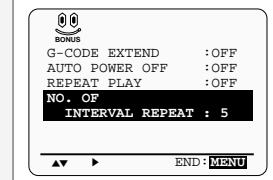

★(SV-641B/SV-445B/SV-240B)

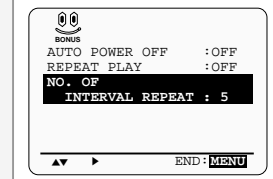

GB

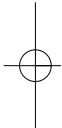

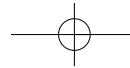

GB

G-CODE EXTEND ★(SV-640B/SV-245B Only)

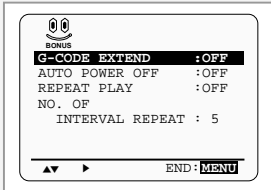

To prevent delays or over-runs the VCR has a function called G-CODE EXTEND allowing you to extend the recording time by up to 60 minutes.

- 1 Press the MENU button on the remote control.
- 2 Press the corresponding ▲, ▼ or ◀, ▶ buttons to select the **EASY OPERATION** option.
- 3 Press the OK button to select this option.
Result: The **EASY OPERATION** menu is displayed.
- 4 Press the corresponding ▲ or ▼ buttons, until the **G-CODE EXTEND** option is selected.
- 5 Press ◀ or ▶ buttons to set the G-CODE EXTEND time by increments of 10 minutes.
- 6 To turn off, press ◀ or ▶ buttons repeatedly until **OFF** shows.

Using the Tape Counter

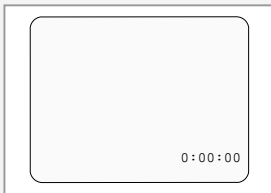

The tape counter:

- ◆ Indicates the elapsed time in the play and record modes (hours, minutes and seconds)
- ◆ Is reset when a cassette is inserted in the VCR
- ◆ Allows you to find the beginning of a sequence easily

➤ If the remaining time is to be calculated correctly, you must indicate the type of cassette being used.

- 1 Insert a cassette in your VCR.
- 2 To set the tape counter to zero at the beginning of a sequence:
 - ◆ Press DISP./○ or DISPLAY twice to display the counter
 - ◆ Press CLR/RST when you want to set the tape counter to zero
- 3 When you are ready,
 - ◆ Start playback or Recording.
 - ◆ Press the ■ button.
 - ◆ To fast-forward or rewind to the sequence at which the counter was set to zero, press ◀◀ or ▶▶.

➤ Some VCR information, such as the counter, can be displayed on the television screen (unless you have deactivated the OSD mode; refer to page 16).

Press DISP./○ or DISPLAY:

- ◆ Once to display the current function, programme number, recording speed ★(SV-641B/SV-640B/SV-445B only), date, time and counter
- ◆ Twice to display the counter only
- ◆ Three times to display the time remaining on the cassette
- ◆ Four times to clear the display

★(SV-641B/SV-640B/SV-445B/SV-245B)

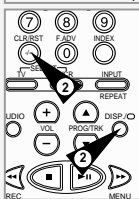

★(SV-240B)

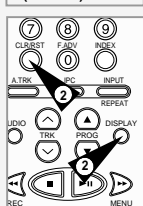

Connecting an RCA Audio/Video Input Cable ★(SV-640B/SV-245B Only)

You can connect other audio/video equipment to your VCR using audio/video cables if the appropriate outputs are available on the equipment chosen.

- Examples:**
- ◆ You wish to copy a video cassette with the help of a second VCR (see page 38).
 - ◆ You wish to play back and/or copy pictures taken with a camcorder (see page 38).
 - ◆ You wish to dub a prerecorded video cassette with sound from a stereo system (see page 39).

- ◆ Regardless of the type of connection chosen, you must always connect the coaxial cable supplied. Otherwise, no picture will be visible on the screen when the VCR is switched off.
- ◆ Make sure that both the television and the VCR are switched off before connecting the cables.

- 1 Connect one end of the RCA audio/video cable into the VIDEO INPUT socket on the front of the VCR.
- 2 Plug the other end of the audio/video cable into the appropriate output connector on the other system (VCR or camcorder).
- 3 Connect one end of the RCA audio cable supplied into the AUDIO INPUT sockets on the front of the VCR.
 - Take care to respect the colour coding of the left and right channels.
- 4 Plug the other end of the audio cable into the appropriate output connectors on the other system (VCR, camcorder or Hi-Fi sound system).

GB

★(SV-640B)

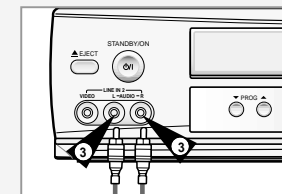
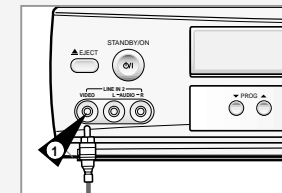

★(SV-245B)

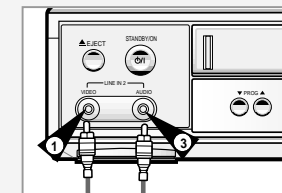

Using the Assemble Edit Function

GB

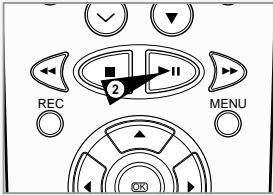

This function allows you to start a new recording at a specific position on the cassette while maintaining a very smooth scene change.

- 1 Insert the cassette to be edited in your VCR.
- 2 Press the ►|| button to start playback.
- 3 When you reach the position from which you wish to start the new recording, press the ►|| button.
- 4 Press the F.ADV (Ⓜ) button again as often as necessary to advance frame by frame, until the exact recording position is located.
- 5 While the VCR is in still mode, hold the REC button down for a while to activate the Assemble Edit function.
Result: Record symbol flashes in the display.
- 6 Select the source from which you wish to record by pressing:
 - ◆ The PROG/TRK (▲ or ▼) / PROG (▲ or ▼) buttons for television channels
 - ◆ The INPUT button for the LINE IN 1 or LINE IN 2
★(SV-640B/SV-245B only) input sources
- 7 Press the ►|| button to start recording.
- 8 When you have finished recording, press ■.

Recording from Another VCR or Camcorder

You can copy a cassette to your VCR from another video source, such as another VCR or a camcorder.

✎ It is an infringement of copyright laws to copy prerecorded cassettes or to re-record them in any form without the permission of the owners of the corresponding copyright.

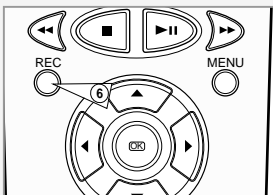
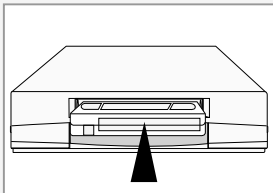

- 1 Connect the VCR, from which the cassette is to be copied, to the appropriate RCA audio and video input connectors on the rear of your VCR, as indicated on page 12.
You can also use an RCA audio and video cable to connect the LINE IN 2 input on the front of your VCR. ★(SV-640B/SV-245B only)
- 2 Insert a blank cassette in your VCR.
- 3 Insert the pre-recorded cassette in the other video source (VCR or camcorder).
- 4 Press the INPUT button to select the appropriate input on your VCR:
 - ◆ LINE IN 1 for the rear input
 - ◆ LINE IN 2 for the front input ★(SV-640B/SV-245B only)
- 5 Start playing back the cassette to be copied.
- 6 Hold REC down for a while to start recording on your VCR.
- 7 When you have finished recording, press ■ on both VCRs.

- If you wish to view the cassette being copied:
- ◆ Your VCR must be connected as usual to the television (see page 11 for further details)

Audio Dubbing a Pre-recorded Cassette ★ (SV-640B Only)

With the Audio Dubbing function, you erase the previously recorded sound and replace it with a new soundtrack from:

- ◆ A CD player
- ◆ A microphone connected to a sound system
- ◆ A cassette player

Restriction:

Audio dubbing is applicable only to the longitudinal audio track (normal audio).

- 1 Connect an RCA audio cable to the appropriate output on your sound system (CD/cassette player for example).
- 2 Connect the other end of the RCA audio cable to the audio input connectors (L, R) on the front of your VCR.
- 3 Insert the pre-recorded cassette on which the audio track is to be replaced, and press the ►|| to start playback.
- 4 Find the scene that you want to over-dub and press ►|| on the remote control.
- 5 Press DUB.
Result: Your VCR is now in the Audio dubbing Pause mode.
- 6 On the sound system, locate the point on the CD or cassette at which you wish to start playback.
Example: The track that you wish to record on the cassette.
- 7 When you are ready:
 - ◆ Start playback on the sound system
 - ◆ Press REC on the remote control.

- The new sound will be recorded on the normal sound track of the tape, and the original sound will remain on the Hi-Fi sound track.
To hear the new sound and original sound mixed together, press the Audio button on the remote control until the MIX option is displayed (see page 32).

GB

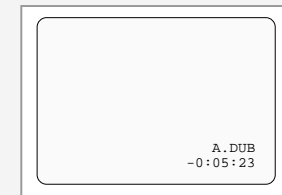
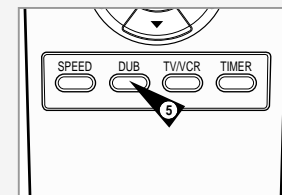
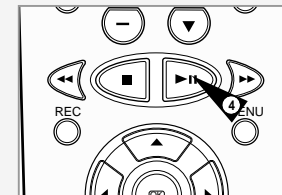
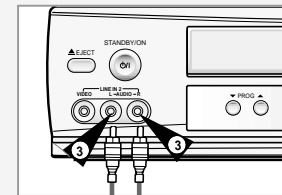
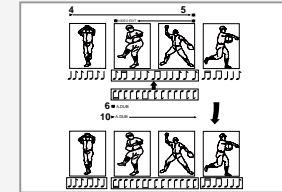

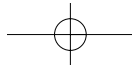

Using the TV Buttons on the Remote Control ★(SV-641B/SV-640B/SV-445B/SV-245B Only)

GB

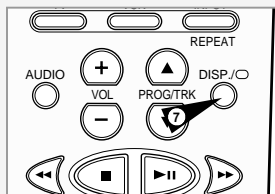
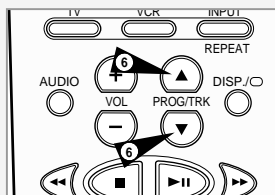
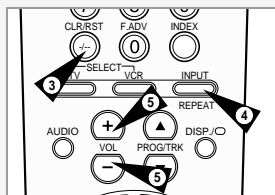
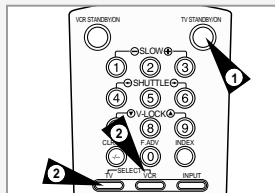

Your VCR remote control will work with Samsung televisions and compatible brands.

To determine whether your television is compatible, follow the instructions below.

- 1 Switch your television on.
- 2 Point the remote control towards the television.
- 3 Hold down the TV button and enter the two-figure code corresponding to the brand of your television, by pressing the appropriate numeric buttons.

Brand	Codes	Brand	Codes
SAMSUNG	01 to 06	PHILIPS	02, 20, 22
AKAI	09, 23	SABA	13, 14, 22 to 24
GRUNDIG	09, 17, 21	SONY	15, 16
LOEWE	02	THOMSON	13, 14, 24
PANASONIC	08, 23 to 27	TOSHIBA	07, 16 to 19, 21

Result: If your television is compatible with the remote control, it will switch off. It is now programmed to operate with the remote control.

➤ If several codes are indicated for your television brand, try each one in turn until you find one that works.

👉 When you change the batteries in the remote control, you must reprogramme the code, following the same procedure.

You can then control the television using the following buttons.

Button	Function
TV STANDBY/ON ①	Used to switch the television on and off.
TV or VCR ②	Used to switch between the TV and VCR modes. Only the VOL (+ or -) and TV STANDBY/ON buttons are operational in VCR mode.
-/- ③	Used to enter a two-figure programme number. Example: For programme 12, press -/- followed by numeric buttons 1 and 2.
INPUT ④	Used to select an external source.
VOL + or - ⑤	Used to adjust the volume of the television.
PROG/TRK ⑥ (▲ or ▼)	Used to select the required programme.
DISP./O ⑦	Used to switch between an external source and the television tuner.

➤ The various functions will not necessarily work on all televisions. If you encounter problems, operate the television directly.

Auto Power Off

The Auto Power Off feature automatically turns off your VCR if no signal is received and you do not press any button for the selected time.

- 1 Press MENU on the remote control.
Result: The programming menu is displayed.
- 2 Press the corresponding ▲, ▼ or ◀, ▶ buttons to select the **EASY OPERATION** option.
- 3 Press the OK button to select this option.
Result: The **EASY OPERATION** menu is displayed.
- 4 Press the corresponding ▲ or ▼ buttons, until the **AUTO POWER OFF** option is selected.
- 5 Press the ▶ button, until you select the time of Auto Power off interval.
OFF → 2HOUR → 3HOUR
- 6 On completion, press MENU twice to exit the menu.

★(SV-640B/SV-245B)

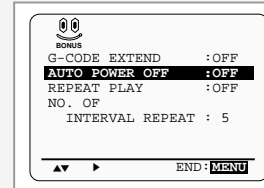

★(SV-641B/SV-445B/SV-240B)

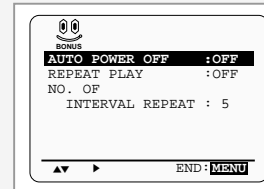

GB

Child Door Lock System ★(SV-640B/SV-245B/SV-240B Only)

With this mechanism you can prevent children from harming themselves or the VCR. It stops fingers and small articles from entering your VCR.

ECO Mode-Reducing Standby power consumption

Low Power Mode reduces the Standby power consumption of the VCR when in Standby mode. Useful, for example, when you are away from the house on holiday. It saves actually turning the VCR off.

- 1 Press MENU on the remote control.
Result: The programming menu is displayed.
- 2 Press the corresponding ▲, ▼ or ◀, ▶ buttons to select the **USER SET** option.
- 3 Press the OK button to select this option.
Result: The **USER SET** menu is displayed.
- 4 Press the corresponding ▲ or ▼ buttons, until the **ECO. MODE** is selected.
- 5 Press the ▶ button to turn LOW(3Watts) mode on. Now, when the VCR is standby mode the front display panel will shut off. Even the clock disappears. By pressing the VCR STANDBY/ON (STANDBY/ON) button again the display panel will reappear.
- 6 On completion, press MENU twice to exit the menu.

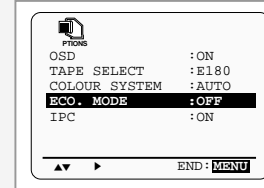
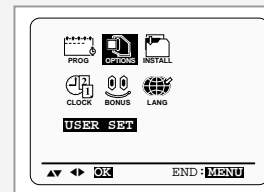

Technical Specifications

Design and specifications are subject to change without notice.

MODEL	SV-641B/ SV-640B	SV-445B/SV-245B/SV-240B
Format Heads	VHS PAL standard Video: 4 rotary heads	VHS PAL standard Video: 4 rotary heads (SV-445B) Video: 2 rotary heads (SV-245B/SV-240B)
Receiving channel	Hi-Fi audio: 2 rotary heads Audio/Control: 1 stationary head Erase: 1 full track erase head VHF-I, VHF-III, UHF, Interband/ Hyperband	Audio/Control: 1 stationary head Erase: 1 full track erase head VHF-I, VHF-III, UHF, Interband/ Hyperband
Television system	STANDARD B/B A2	STANDARD B/B
Luminance	FM azimuth recording	FM azimuth recording
Colour system	PAL/MESECAM/NT4.43: Down converted subcarrier phase shifted direct recording	PAL/MESECAM/NT4.43: Down converted subcarrier phase shifted direct recording
Tape speed	NTSC PB on PAL TV SP 23.39 mm/sec LP 11.69 mm/sec	NTSC PB on PAL TV SP 23.39 mm/sec LP 11.69 mm/sec (SV-445B only)
Recording/playback time	SP 3 hours (E-180 Tape) LP 6 hours (E-180 Tape)	SP 3 hours (E-180 Tape) LP 6 hours (E-180 Tape) (SV-445B only)
REW time	About 60 sec in REW with E-180	About 60 sec in REW with E-180
VIDEO Input Output Signal-to-noise ratio Horizontal resolution	0.5 to 2.0 Vp-p; 75 ohm unbalanced 1.0 ± 0.2 Vp-p; 75 ohm unbalanced Better than 43 dB (SP) More than 240 lines	0.5 to 2.0 Vp-p; 75 ohm unbalanced 1.0 ± 0.2 Vp-p; 75 ohm unbalanced Better than 43 dB (SP) More than 240 lines
AUDIO Input Output Wow and flutter (WTD) Signal-to-noise ratio Frequency response	-8 dBm, 47 Kohm unbalanced -8 ± 3 dBm, 1 Kohm unbalanced 0.4% max (SP) 68 dB min (IHF A filter) 20Hz - 20kHz	-8 dBm, 47 Kohm unbalanced -8 ± 3 dBm, 1 Kohm unbalanced 0.4% max (SP) 42 dB min (IHF A filter) 100Hz - 8kHz
Power requirement Power consumption Operation temperature Operation humidity Weight Dimensions (WxHxD)	AC 240V 50/60 Hz Approx. 17 watts 41°F-104°F (5°C-40°C) 10%-75% 2.8 Kg (net) 360 x 94 x 240 mm	AC 240V 50/60 Hz Approx. 15 watts 41°F-104°F (5°C-40°C) 10%-75% 2.8 Kg (net) 360 x 94 x 240 mm

Problems and Solutions

Before contacting the Samsung after-sales service, perform the following simple checks.

Problem	Explanation/Solution
No power	<ul style="list-style-type: none"> ◆ Check that the power plug is connected to a wall outlet. ◆ Have you pressed the VCR STANDBY/ON (STANDBY/ON) button?
You cannot insert a video cassette	<ul style="list-style-type: none"> ◆ A video cassette can only be inserted with the window side up and the safety tab facing you.
The television programme was not recorded	<ul style="list-style-type: none"> ◆ Check the VCR aerial connections. ◆ Is the VCR tuner properly set? ◆ Check if the safety tab is intact on the cassette.
Timer recording was unsuccessful	<ul style="list-style-type: none"> ◆ Was the VCR STANDBY/ON (STANDBY/ON) button pressed to activate the timer? ◆ Re-check the recording start/stop time settings. ◆ If there was a power failure or interruption during timer recording, the recording will have been cancelled.
No playback picture or the picture is distorted	<ul style="list-style-type: none"> ◆ Check to see if you are using a prerecorded tape.
You cannot see normal broadcasts	<ul style="list-style-type: none"> ◆ Check the TUNER/EXTERNAL setting. It should be on TUNER. ◆ Check the TV/VCR aerial connections.
Noise bars or streaks on playback	<ul style="list-style-type: none"> ◆ Press the PROG/TRK (▲ or ▼) / TRK (↵ or ↶) buttons to minimize this effect.
When the ► button is pressed during playback, the still picture has severe "noise bars" streaks	<ul style="list-style-type: none"> ◆ A still picture may have "noise bars", depending on the condition of the tape. Press the PROG/TRK (▲ or ▼) / TRK (↵ or ↶) buttons during SLOW motion to minimize this effect.
Video Head Cleaning	<ul style="list-style-type: none"> ◆ If poor pictures appear on a variety of cassettes, the video heads may need cleaning. This is not a common problem and unless it appears, the heads should not be cleaned. When cleaning the video heads, read all instructions provided with the head cleaning cassette. Incorrect head cleaning can permanently damage the video heads.
If when tuning in your TV to the VCR test pattern your TV does not find the test pattern or the pattern when found suffers from interference, it may be due to the VCR output channel clashing with the normal TV transmissions in your area. To prevent this you will need to change the VCR output channel in the following way	<ol style="list-style-type: none"> 1. Remove the aerial input plug from the socket marked (aerial symbol) on the rear of the VCR. 2. Carry out the instructions "Tuning Your Television for the VCR" (see page 14). 3. Carry out the instructions "Setting the VCR output Channel" (see page 17), move the channel number several channels down from the original setting. (example: from 38 to 33). 4. Replace the aerial plug into the socket marked (aerial symbol) on the rear of the VCR. 5. Re-tune your TV to the VCR again by following instructions "Tuning Your Television for the VCR" (page 14). 6. If the problem still exists repeat steps 1 to 5 moving several more channels away from the original setting.

If you are unable to solve the problem after reading the above instructions, note:

- ◆ The model and serial number on the rear of your VCR
- ◆ The warranty information
- ◆ A clear description of the problem

Then contact your nearest SAMSUNG after-sales service.

TV Frequency Table

GB

DISP	CH	Band	Fp	STD
00	00	V-L	46.25	AUS
01	01	V-L	57.25	AUS
02	02	V-L	64.25	AUS
03	03	V-L	86.25	AUS
04	04	V-L	95.25	AUS
05	05	V-L	102.25	AUS
15	5A	V-L	138.25	AUS
06	06	V-H	175.25	AUS
07	07	V-H	182.25	AUS
08	08	V-H	189.25	AUS
09	09	V-H	196.25	AUS
19	9A	V-H	203.25	AUS
10	10	V-H	209.25	AUS
11	11	V-H	216.25	AUS
12	12	V-H	224.25	AUS
27	27	UHF	520.25	AUS
28	28	UHF	527.25	AUS
29	29	UHF	534.25	AUS
30	30	UHF	541.25	AUS
31	31	UHF	548.25	AUS
32	32	UHF	555.25	AUS
33	33	UHF	562.25	AUS
34	34	UHF	569.25	AUS
35	35	UHF	576.25	AUS
36	36	UHF	583.25	AUS
37	37	UHF	590.25	AUS
38	38	UHF	597.25	AUS
39	39	UHF	604.25	AUS
40	40	UHF	611.25	AUS
41	41	UHF	618.25	AUS
42	42	UHF	625.25	AUS
43	43	UHF	632.25	AUS
44	44	UHF	639.25	AUS
45	45	UHF	646.25	AUS
46	46	UHF	653.25	AUS
47	47	UHF	660.25	AUS
48	48	UHF	667.25	AUS
49	49	UHF	674.25	AUS
50	50	UHF	681.25	AUS
51	51	UHF	688.25	AUS
52	52	UHF	695.25	AUS
53	53	UHF	702.25	AUS
54	54	UHF	709.25	AUS
55	55	UHF	716.25	AUS
56	56	UHF	723.25	AUS
57	57	UHF	730.25	AUS
58	58	UHF	737.25	AUS
59	59	UHF	744.25	AUS
60	60	UHF	751.25	AUS
61	61	UHF	758.25	AUS
62	62	UHF	765.25	AUS
63	63	UHF	772.25	AUS
64	64	UHF	779.25	AUS
65	65	UHF	786.25	AUS
66	66	UHF	793.25	AUS
67	67	UHF	800.25	AUS
68	68	UHF	807.25	AUS
69	69	UHF	814.25	AUS

THIS APPLIANCE IS DISTRIBUTED BY

