

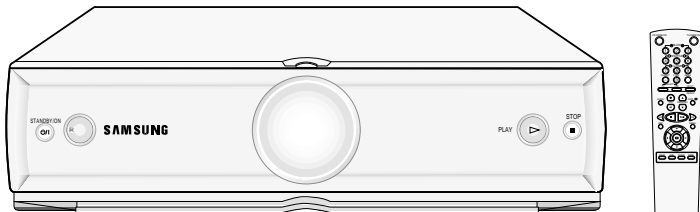

**VIDEO
CASSETTE RECORDER
Hi-Fi NICAM & A2 STEREO
SV-640GS**

Instruction Manual



- ◆ FOREWORD
 - Safety Instructions 4
- ◆ VCR OVERVIEWS
 - Front View of the VCR 5
 - Rear View of the VCR 5
 - Infrared Remote Control 6
 - Display Indicator 7
 - Accessories 7
- ◆ CONNECTING YOUR VIDEO CASSETTE RECORDER
 - Deciding How to Connect Your VCR 8
 - Connecting Your VCR to the TV using the Coaxial Cable 9
 - Connecting Your VCR to the TV using the RCA Cable 9
 - Connecting Other Equipment to Your VCR 10
 - Plug & Auto Set Up 11
 - Tuning your Television for the VCR 12
- ◆ SETTING UP YOUR VIDEO CASSETTE RECORDER
 - Inserting Batteries in the Remote Control 13
 - Setting the Date and Time 13
 - Displaying/Hiding On-Screen Information 14
 - Choosing Your Language 14
 - Setting the VCR Output Channel 15
 - Selecting the RF OUT sound Mode (G or K) 15
 - Presetting the Stations Automatically 16
 - Presetting the Stations Manually 17
 - Clearing a Preset Station 18
 - Changing the Preset Station Table 19
- ◆ RECORDING TELEVISION BROADCASTS
 - Selecting the Cassette Type 20
 - Selecting the Recording Speed 20
 - NICAM 21
 - Protecting a Recorded Cassette 22
 - Recording a Programme Immediately 22
 - Recording a Programme with Automatic Stop 23
 - Using the Timer Programming Feature 24
 - Checking a Preset Recording 25
 - Cancelling a Preset Recording 25

- ◆ PLAYING BACK
 - Playing a Cassette 26
 - Adjusting Picture Alignment Manually 26
 - Intelligent Picture Control 27
 - Selecting the Colour Mode 28
 - Selecting the Audio Output Mode 28
- ◆ SEARCHING FOR A SEQUENCE
 - Playing a Cassette in Slow Motion 29
 - Playing a Sequence Frame by Frame 29
 - Picture Search, Fast Forward/Rewind 30
 - Searching for a Specific Sequence 30
 - Auto Repeat Play 31
 - Interval Repeat Play 31
 - Using the Tape Counter 32
- ◆ ADVANCED RECORDING FEATURES
 - Connecting RCA Audio/Video Input Cable 33
 - Using the Assemble Edit Function 34
 - Recording from Another VCR or Camcorder 34
- ◆ OTHER FUNCTIONS AND USEFUL RECOMMENDATIONS
 - Using the TV Buttons on the Remote Control 35
 - Auto Power Off 36
 - ECO Mode-Reducing Standby power consumption 36
 - Technical Specifications 37
- ◆ SOLVING PROBLEMS
 - Problems and Solutions 38
 - TV Frequency Table 39

Symbols

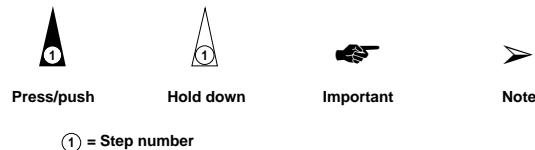

Safety Instructions

The following illustrations represent precautions.



The lightning bolt is a warning sign alerting you to dangerous voltage inside the product. DO NOT OPEN THE VCR. Refer to service personnel.

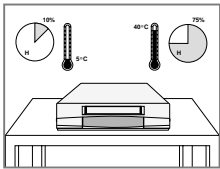

Do NOT expose the VCR to extreme temperature conditions (below 5°C and above 40°C) or to extreme humidity conditions (less than 10% and more than 75%).

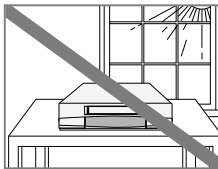

Do NOT expose the VCR to direct sunlight.

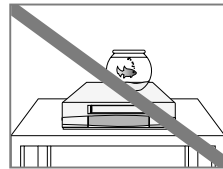

Do NOT expose the VCR to any liquids.

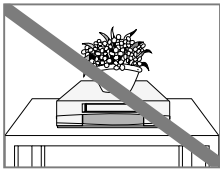

Do NOT place any objects on the VCR or remote control.

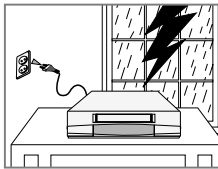

During a storm and/or lightning, unplug the VCR from the mains socket and aerial.

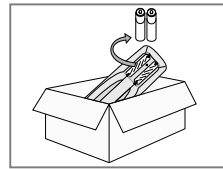

If the remote control is not used for a long period of time, remove the batteries and store it in a cool, dry place.

THIS DEVICE IS NOT FOR USE IN INDUSTRIAL ENVIRONMENTS

Front View of the VCR

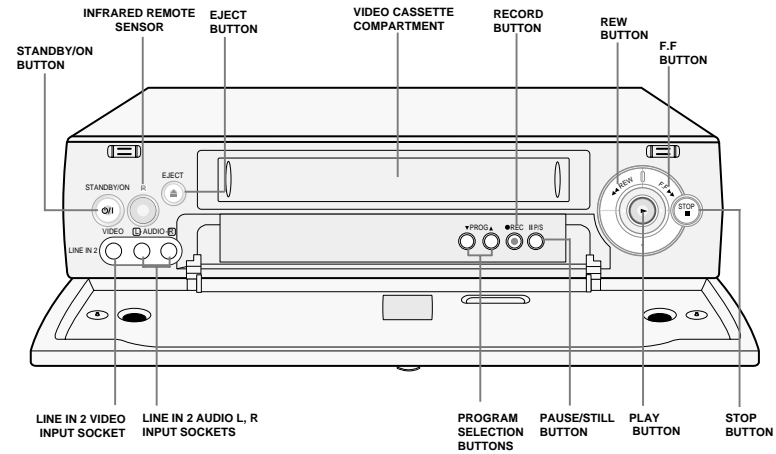

Rear View of the VCR

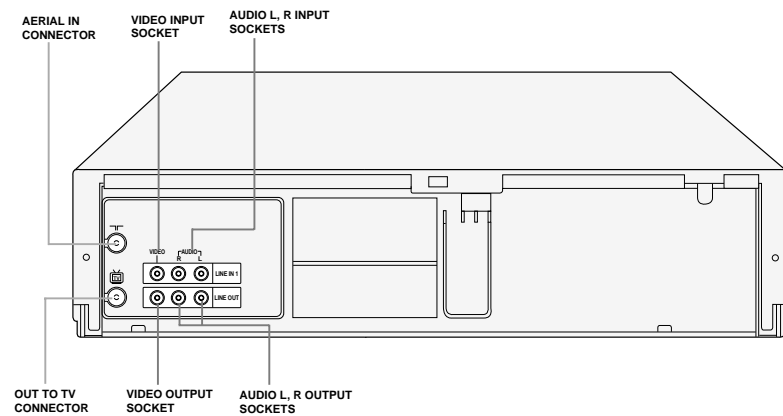

Infrared Remote Control

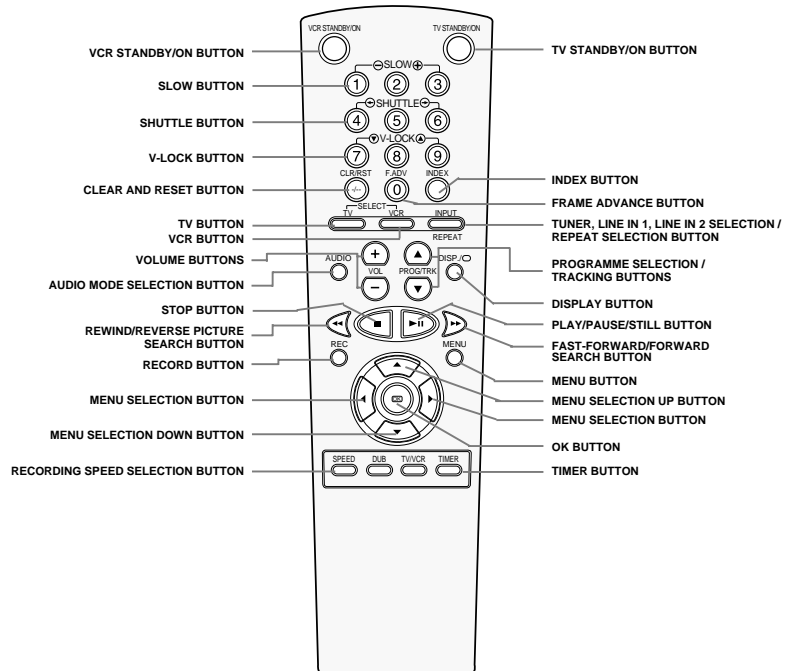

Display Indicator

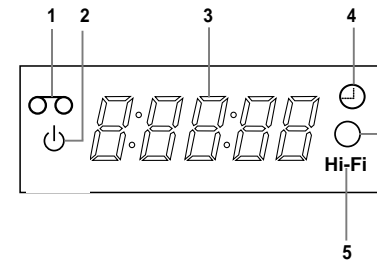

- 1 Cassette loaded indicator
- 2 ECO Mode display
- 3 Multi-function display
- 4 Timer indicator
- 5 Hi-Fi indicator
- 6 Rec indicator

Accessories

You have just purchased a SAMSUNG Video Cassette Recorder (VCR).
Together with your VCR, you will find the following accessories in the box.

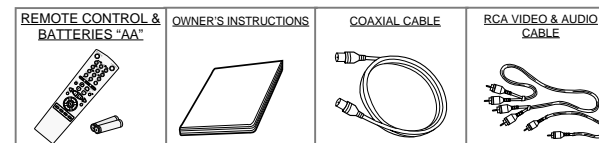











Deciding How to Connect Your VCR

You must take into account various factors when connecting audio or video systems:

- ◆ Types of connectors available on your systems
- ◆ Systems connected permanently to the VCR (satellite receiver for example) or temporarily (camcorder for example)

Your VCR is equipped with the following connectors.

Connector	Location	Type	Direction	Recommended Use
LINE IN 1	Rear 	Audio/Video RCA	In 	<ul style="list-style-type: none"> ◆ Camcorder ◆ Satellite receiver ◆ Other VCR
Audio/Video output	Rear 	Audio/Video RCA	Out 	<ul style="list-style-type: none"> ◆ Television ◆ Other VCR ◆ Audio Hi-Fi system
LINE IN 2	Front 	Audio/Video RCA	In 	<ul style="list-style-type: none"> ◆ Audio Hi-Fi system ◆ Camcorder ◆ Other VCR
OUT TO TV	Rear 	75 Ω coaxial	Out 	<ul style="list-style-type: none"> ◆ Television
IN FROM ANT.	Rear 	75 Ω coaxial	In 	<ul style="list-style-type: none"> ◆ Aerial ◆ Cable television network ◆ Satellite receiver

Whenever you connect an audio or video system to your VCR, ensure that all elements are switched off.



Refer to the documentation supplied with your equipment for detailed connection instructions and associated safety precautions.

Connecting Your VCR to the TV using the Coaxial Cable

To receive television programmes a signal must be received from one of the following sources:

- ◆ An outdoor aerial
- ◆ An indoor aerial
- ◆ A cable television network
- ◆ A satellite receiver

Make sure that both the television and the VCR are switched off before connecting the cables.

- 1 Remove the aerial or network input cable from the television.
- 2 Connect this cable to the 75Ω coaxial socket marked  on the rear of your VCR.
- 3 Plug the coaxial cable supplied into the  socket on your VCR.
- 4 Plug the other end of the coaxial cable into the connector previously used for the aerial on the television.
- 5 To obtain better quality pictures and sound on your television, you can also connect your VCR to the television via the RCA cable (see section below) if your television is equipped with this type of connection.

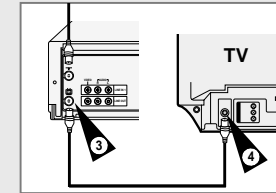
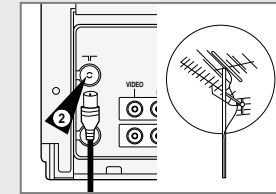

Connecting Your VCR to the TV using the RCA Cable

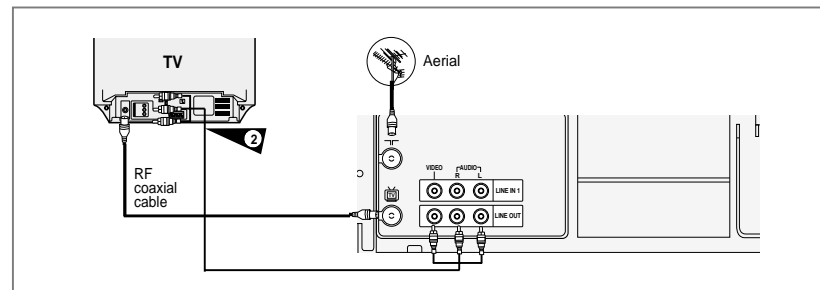

You can connect your VCR to the television using the RCA cable if the appropriate input is available on the television. You thus:

- ◆ Obtain better quality sound and pictures
- ◆ Simplify the setting up procedure of your VCR

Regardless of the type of connection chosen, you must always connect the coaxial cable supplied. Otherwise, no picture will be visible on the screen when the VCR is switched off. Make sure that both the television and the VCR are switched off before connecting the cables.

- 1 Connect the coaxial cable as indicated in the above section.
- 2 Connect one end of the RCA Audio/Video cable to the Video output and Audio L, R output socket on the rear of the VCR.
- 3 Plug the other end into the appropriate connector on the television.

Connecting Other Equipment to Your VCR

You can connect other audio and/or video equipment to your VCR in different ways. The following illustrations give a few examples of the connection possibilities.

➤ The RCA input/output connectors on the front of the VCR are used for equipment, such as camcorders, VCRs or sound systems.

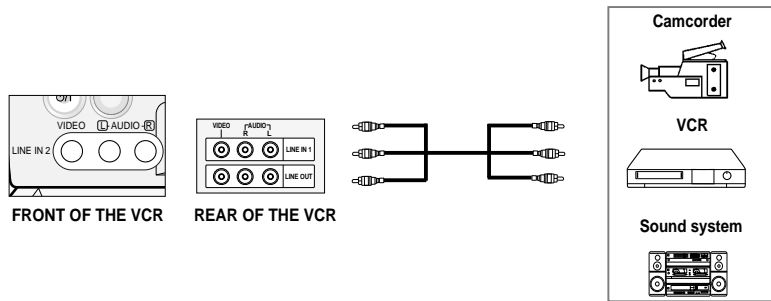

Plug & Auto Set Up

Your VCR will automatically set itself up when it is plugged into the mains for the first time. TV stations will be stored in memory. The process takes a few minutes. Your VCR will then be ready for use.

- 1 Connect the coaxial cable as indicated on page 9.
(Connecting Your VCR to the TV Using the Coaxial Cable)
- 2 Plug the VCR into the mains.
Result: The **LANGUAGE SET** menu is displayed.
- 3 Select the required language by pressing the **▲** or **▼** buttons.
- 4 Press OK to store the language selected.
Result: A message appears.
- 5 Press OK to start the auto scanning.
◆ The number of stations automatically stored by the VCR depends on the number of stations that it has found.
- 6 On completion, press MENU twice to exit the menu.

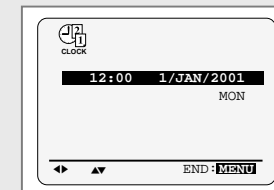
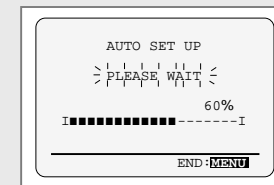
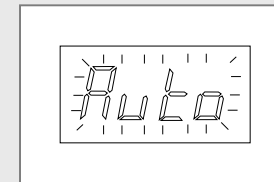
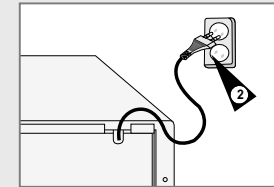
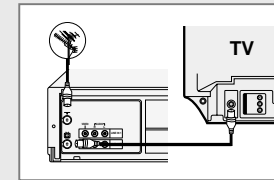

Tuning Your Television for the VCR

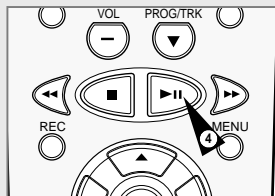
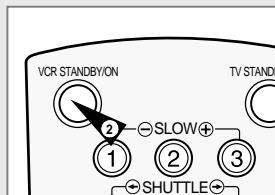

You must tune your television for the VCR only if you are not using a RCA cable

➤ To view pictures from your VCR when a RCA cable is used, the television must be set to the audio/video mode (AV).

- 1 Switch on the television.
- 2 Switch on the VCR by pressing STANDBY/ON on the front of the VCR or VCR STANDBY/ON on the remote control.
- 3 Select a programme position on the television to be reserved for use with your VCR.
- 4 Insert the video cassette in the VCR. Check that the VCR starts reading the cassette; if not, press ►|| button.
- 5 Start a scan on your television or set the television to UHF channel 36.
- 6 Fine tune the television until the pictures and sound are obtained clearly.
- 7 If you cannot find the pictures and sound, or there is interference from nearby channels, it may be necessary to change the setting of the VCR output channel (see Solving Problems section of this manual).
- 8 When the picture and sound are perfectly clear, store this channel at the desired programme position on the television.
Result: That programme is now reserved for use with your VCR.

Inserting Batteries in the Remote Control



You must insert or replace the batteries in the remote control when you:

- ◆ Purchase the video cassette recorder
- ◆ Find that the remote control is no longer working correctly

- 1 Push the tab in the direction of the arrow to release the battery compartment cover on the rear of the remote control.
- 2 Insert two AA, R6 or equivalent batteries, taking care to respect the polarities:
 - ◆ + on the battery with + on the remote control
 - ◆ - on the battery with - on the remote control
- 3 Replace the cover by aligning it with the base of the remote control and pushing it back into place.

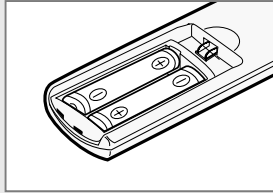
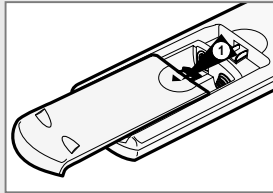

- Do not mix different battery types (manganese and alkaline for example).

Setting the Date and Time

Your VCR contains a 24-hour clock and calendar used to:

- ◆ Automatically stop programme recording
- ◆ Preset your VCR to record a programme automatically

You must set the date and time when:

- ◆ You purchase the video cassette recorder
- ◆ The power supply remains off for more than 1 hour

- ☞ Do not forget to reset the time when you change clocks from winter to summer time and vice versa.

- 1 Press MENU on the remote control.
Result: The programming menu is displayed.
- 2 Press the corresponding ▲, ▼ or ◀, ▶ buttons to select the **CLOCK SET** option.
- 3 Press the OK button to select this option.
Result: The **CLOCK SET** menu is displayed.
- 4 Press ◀ or ▶ to select the hour, minutes, day, month and year.
Result: The option selected flashes.
- 5 Press the ▲ or ▼ buttons to increase or decrease the value.
Result: The day of the week is displayed automatically.
 - You can hold the ▲ or ▼ buttons down to scroll more quickly through the values.
- 6 On completion, press MENU twice to exit the menu.

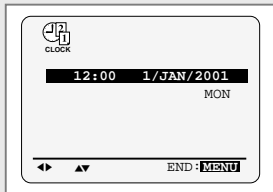
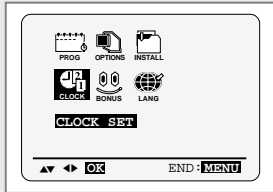
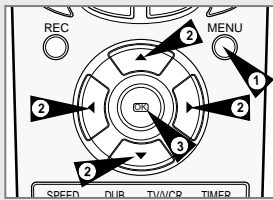

Displaying/Hiding On-Screen Information

Your VCR displays most information both on the VCR and the television.

You can choose to display or hide this information on the television screen (except for the Index, Programming MENU which cannot be hidden).

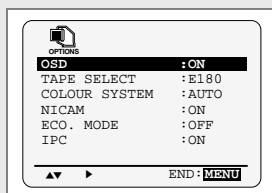
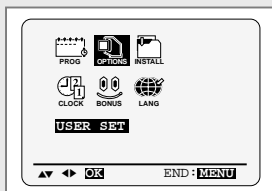

- 1 Press MENU on the remote control.
Result: The programming menu is displayed.
- 2 Press the corresponding ▲, ▼ or ◀, ▶ buttons to select the **USER SET** option.
- 3 Press the OK button to select this option.
Result: The **USER SET** menu is displayed.
- 4 Press the corresponding ▲ or ▼ buttons, until the **OSD** option is selected.
- 5 **To...** **Press ◀ or ▶, until...**

Display on-screen information	ON is displayed.
Hide on-screen information	OFF is displayed.
- 6 On completion, press MENU twice to exit the menu.

Choosing Your Language

You can change the language in which information is displayed on the screen.

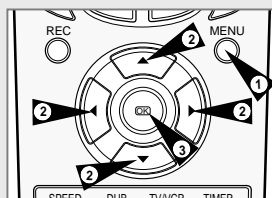

- 1 Press MENU on the remote control.
Result: The programming menu is displayed.
- 2 Press the corresponding ▲, ▼ or ◀, ▶ buttons to select the **LANGUAGE SET** option.
- 3 Press the OK button to select this option.
Result: The **LANGUAGE SET** menu is displayed.
- 4 Select the required language by pressing the ▲ or ▼ buttons.
- 5 Press OK to store the language selected.
- 6 Press MENU to exit the menu.
Result: From now on, all the on-screen information will be displayed in the language selected.

Setting the VCR Output Channel

Your VCR output channel may need to be changed if the pictures suffer from interference or if your TV cannot find the pictures. Also, you can change the VCR output channel to adjust the frequency in which information is displayed on the screen.

- 1 Press MENU on the remote control.
Result: The programming menu is displayed.
- 2 Press the corresponding ▲, ▼ or ◀, ▶ buttons to select the **INSTALLATION** option.
- 3 Press the OK button to select this option.
Result: The **INSTALLATION** menu is displayed.
- 4 Press the corresponding ▲ or ▼ buttons, until the **VCR OUTPUT CH** option is selected.
- 5 Select the required output channel by pressing the ◀ or ▶ buttons.
- 6 On completion, press MENU twice to exit the menu. Then tune your television again (see page 12).

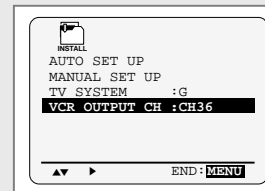

Selecting the RF OUT Sound Mode (G or K)

You must choose the sound mode (G or K) according to the TV set connected to your VCR.

- 1 Press MENU on the remote control.
Result: The programming menu is displayed.
- 2 Press the corresponding ▲, ▼ or ◀, ▶ buttons to select the **INSTALLATION** option.
- 3 Press the OK button to select this option.
Result: The **INSTALLATION** menu is displayed.
- 4 Press the corresponding ▲ or ▼ buttons, until the **TV SYSTEM** option is selected.
- 5 Press the ▶ button to select G or K.
- 6 On completion, press MENU twice to exit the menu.

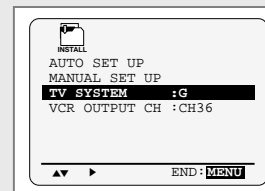

Presetting the Stations Automatically

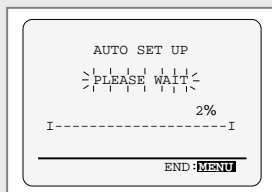
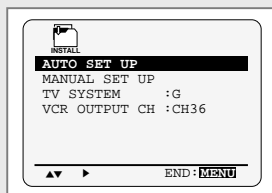
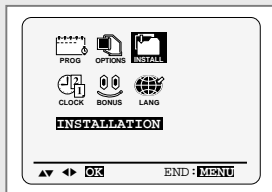

You do not need to preset the stations if you have already set them automatically (see Plug & Auto Set Up on page 11).

Your VCR contains a built-in tuner used to receive television broadcasts.

You must preset the stations received through the tuner. This can be done:

- ◆ Plug & Auto Set up (see page 11)
- ◆ Automatically
- ◆ Manually (see page 17)

You can store up to 50 stations.

- 1 Press the MENU button on the remote control.
Result: The programming menu is displayed.
 - 2 Press the corresponding ▲, ▼ or ◀, ▶ buttons to select the **INSTALLATION** option.
 - 3 Press the OK button to select this option.
Result: The **INSTALLATION** menu is displayed.
 - 4 Press the corresponding ▲ or ▼ buttons, until the **AUTO SET UP** option is selected.
Press the ▶ button to select this option.
 - 5 Press OK to start the auto scanning.
Result:
 - ◆ The **PLEASE WAIT** indication flashes on the television screen.
 - ◆ The first frequency band is scanned and the first station found is displayed and stored.
 - ◆ The VCR then searches for the second station and so on.
 - ◆ When the automatic scanning procedure has finished, the VCR switches automatically to programme 1.
- The number of stations automatically stored by the VCR depends on the number of stations that it has found.
- 6 If you wish to cancel the auto scanning before the end, press the MENU button three times to exit the menu.

➤ ◆ Once the auto scanning procedure has finished, some stations may have been stored more than once; select the stations with the best reception and delete the ones no longer required (see page 18).

Presetting the Stations Manually

Your VCR contains a built-in tuner used to receive television broadcasts.

You must preset the stations received through the tuner. This can be done:

- ◆ Plug & Auto Set up (see page 11)
- ◆ Automatically (see page 16)
- ◆ Manually

You can store up to 50 stations.

You do not need to preset the stations manually if you have already set them automatically.

- 1 Press the MENU button on the remote control.
Result: The programming menu is displayed.
 - 2 Press the corresponding ▲, ▼ or ◀, ▶ buttons to select the **INSTALLATION** option.
 - 3 Press the OK button to select this option.
Result: The **INSTALLATION** menu is displayed.
 - 4 Press the corresponding ▲ or ▼ buttons, until the **MANUAL SET UP** option is selected.
 - 5 Press the ▶ button to select **MANUAL SET UP** option.
Result: The **TV STATION TABLE** menu is displayed.
 - 6 Press the ▲ or ▼ buttons to select a programme number as required.
 - 7 Press the ▶ button to preset the station.
Result: The **MANUAL TUNING** menu is displayed.
 - 8 Press the ◀ or ▶ buttons to start scanning.
Result: The frequency band is scanned and the first station found is displayed.
If you know the number of the channel you want, press the numeric buttons on the remote control for example, for channel 04, first press "0" and then press "4" (see page 39).
- | | |
|---|--|
| 9 If you... | Then... |
| Wish to store the station displayed | <ul style="list-style-type: none"> ◆ Press the corresponding ▲ or ▼ buttons, until the MFT is selected. ◆ Press the ◀ or ▶ buttons to adjust the picture, if necessary. ◆ Press OK to store the station . |
| Do not wish to store the station displayed | <ul style="list-style-type: none"> ◆ Press the corresponding ▲ or ▼ buttons, until the CH is selected. ◆ Press the ◀ or ▶ buttons to go on scanning the frequency band and display the next station ◆ Go back to the beginning of Step 9 |
- 10 Repeat this procedure from Step 6 onwards, until all the required stations have been stored.
 - 11 On completion, press the MENU button three times to exit the menu.

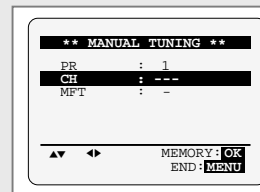
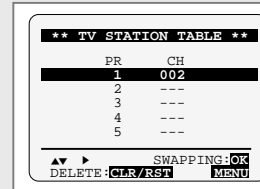
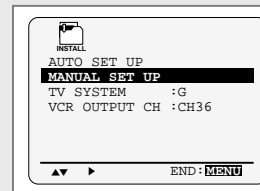
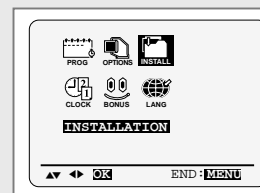

Clearing a Preset Station

If you have stored a TV station:

- ◆ That you do not require
- ◆ At the wrong programme position

you can cancel it.

- 1 Press the MENU button on the remote control.
Result: The programming menu is displayed.
- 2 Press the corresponding ▲, ▼ or ◀, ▶ buttons to select the **INSTALLATION** option.
- 3 Press the OK button to select this option.
Result: The **INSTALLATION** menu is displayed.
- 4 Press the corresponding ▲ or ▼ buttons, until the **MANUAL SET UP** option is selected.
- 5 Press the ▶ button to select this option.
Result: The **TV STATION TABLE** menu is displayed.
- 6 Press the corresponding ▲ or ▼ buttons, until the required preset TV station (PR) is selected.
- 7 Press the CLR/RST button.
- 8 Repeat the same procedure from Step 6 onwards until all the required stations have been cleared.
- 9 On completion, press the MENU button three times to exit the menu.

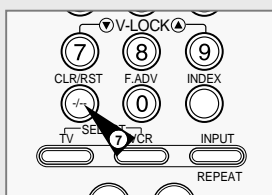
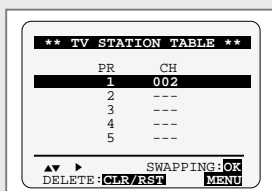
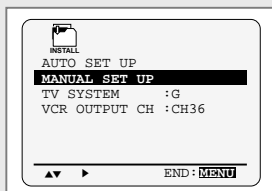
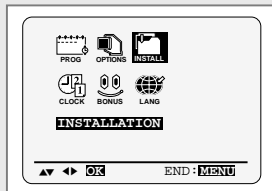

Changing the Preset Station Table

You can rearrange the preset TV stations according to your own preferences programme number assigned to the station.

- 1 Press the MENU button on the remote control.
Result: The programming menu is displayed.
- 2 Press the corresponding ▲, ▼ or ◀, ▶ buttons to select the **INSTALLATION** option.
- 3 Press the OK button to select this option.
Result: The **INSTALLATION** menu is displayed.
- 4 Press the corresponding ▲ or ▼ buttons, until the **MANUAL SET UP** option is selected.
And then press the ▶ button to select this option.
Result: The **TV STATION TABLE** menu is displayed.
- 5 Press the corresponding ▲ or ▼ buttons, until the required preset TV programme is selected.
Result: The selected station is displayed at the same time on the television screen.
- 6 To change the programme number assigned to a station press the OK button on the remote control. (For example, To move a TV station in programme 1 to programme 3)
- 7 Press the ▲ or ▼ buttons to select required position. And then press OK again to swap the position.
- 8 You can modify this station by repeating the same procedure from Step 5 onwards.
- 9 On completion, press the MENU button three times to exit the menu.

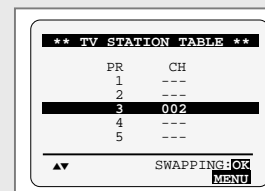
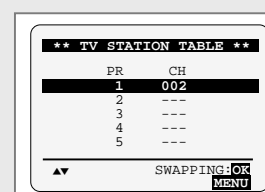
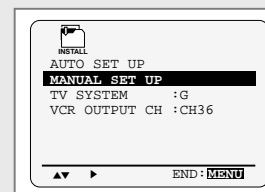
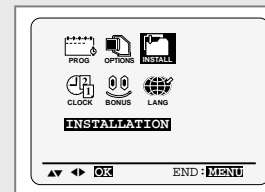

Selecting the Cassette Type

If you wish to use the tape counter to display the time remaining on a cassette, you must indicate the type of cassette inserted.

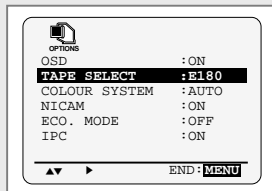
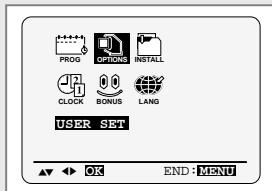

- 1 Press MENU on the remote control.
Result: The programming menu is displayed.
- 2 Press the corresponding ▲, ▼ or ◀, ▶ buttons to select the **USER SET** option.
- 3 Press the OK button to select this option.
- 4 Press the corresponding ▲ or ▼ buttons, until the **TAPE SELECT** option is selected.

▶	E180	▶	E240
▶	E 300	◀	E260
- 5 Press the ◀ or ▶ buttons as many times as required, until the correct cassette length is displayed.
- 6 Press MENU twice to exit the menu.

Selecting the Recording Speed

Type	Recording Time (in SP)
E-180	180 mins. or 3 hours
E-240	240 mins. or 4 hours
E-260	260 mins. or 4 hours and 20 mins.
E-300	300 mins. or 5 hours

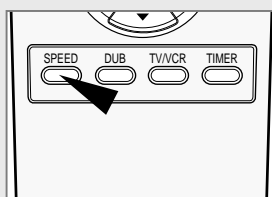

You can record a cassette at two different speeds:

- ◆ *SP (Standard Play)*
- ◆ *LP (Long Play)*

In Long Play modes:

- ◆ *Each cassette lasts twice as long*

To record a cassette... Press the **SPEED** button on the remote control, until...

- In standard play mode **SP** is displayed.
 In long play mode **LP** is displayed.

NICAM

NICAM programmes are divided into 3 types. *NICAM Stereo, NICAM Mono and Bilingual (transmission in another language).* *NICAM programmes are always accompanied by a standard mono sound broadcast and you can select the desired sound. Please refer to page 28.*

- 1 Press MENU on the remote control.
Result: The programming menu is displayed.
- 2 Press the corresponding ▲, ▼ or ◀, ▶ buttons to select the **USER SET** option.
- 3 Press the OK button to select this option.
Result: The **USER SET** menu is displayed.
- 4 Press the corresponding ▲ or ▼ buttons, until the **NICAM** option is selected.
- 5 **To...** Press ◀ or ▶, until...

Mono mode	OFF is displayed. OFF: Only set at this position to record the standard mono sound during a NICAM broadcast if the stereo sound is distorted due to inferior reception conditions.
NICAM mode	ON is displayed. ON: Normally set at this position.
- 6 On completion, press MENU twice to exit the menu.

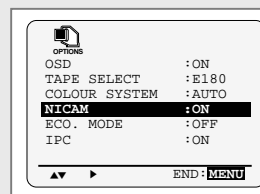
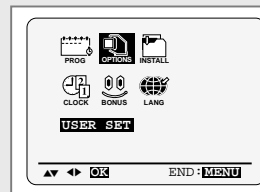

Protecting a Recorded Cassette

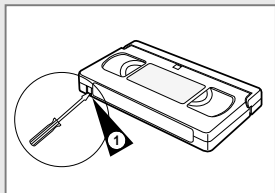

Video cassettes have a safety tab to prevent accidental erasure. When this tab has been removed, you cannot record on the tape.

- 1 If you wish to protect a cassette, break off the tab using a small screwdriver.
- 2 To re-record over a protected cassette (safety tab broken), cover the hole with adhesive tape.

Recording a Programme Immediately

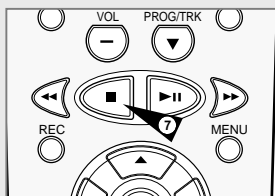
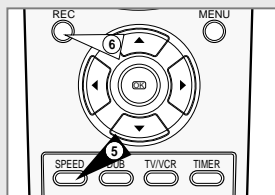
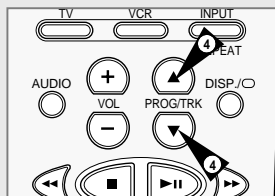

Before recording a programme, you must have preset the corresponding station (unless you are recording via an external video source). If you have not done so, refer to pages 16 and 17.

- 1 Switch on the television.
- 2 To monitor the programme being recorded, select the television channel reserved for use with your VCR (or the AV input if used).
- 3 Insert the cassette on which the programme is to be recorded, with the window visible and the safety tab intact or the opening covered with adhesive tape.
Result: The VCR is switched on automatically.
- 4 Select:
 - ◆ The station to be recorded using the PROG/TRK (▲ or ▼) buttons
 - or
 - ◆ The LINE IN 1 or LINE IN 2 source using the INPUT button for a satellite tuner or external video source**Result:** The station number is displayed and the programme can be seen on the television.
- 5 Select the recording speed (SP/LP) by pressing the SPEED button as many times as required (see page 20).
- 6 Hold REC down for a while to start recording.
Result: The record indicator appears on the television and VCR display. An index is recorded on the tape (see page 30).
- 7 To stop recording, press ■ once.

-
- ◆ If the cassette is ejected when you start recording, check that the safety tab is intact or the opening is covered with adhesive tape.
 - ◆ If you reach the end of the tape while recording, the cassette rewinds automatically.

Recording a Programme with Automatic Stop

This function enables you to record up to nine hours of programmes. (LP)

Your VCR stops automatically after the requested length of time.

- 1 Switch on the television.
- 2 To monitor the programme being recorded, select the television channel reserved for use with your VCR (or the AV input if used).
- 3 Insert the cassette on which the programme is to be recorded, with the window visible and the safety tab intact or the opening covered with adhesive tape.
Result: The VCR is switched on automatically.
- 4 Select:
 - ◆ The station to be recorded using the PROG/TRK (▲ or ▼) buttons
 - or
 - ◆ The LINE IN 1 or LINE IN 2 source using the INPUT button for a satellite tuner or external video source**Result:** The channel number is displayed and the programme can be seen on the television.
- 5 Select the recording speed (SP/LP) by pressing the SPEED button as many times as required (see page 20).
- 6 Hold the REC button down for a while to start recording.
Result: The record indicator appears on the television screen and VCR display. An index is recorded on the tape (see page 30).
- 7 Press the REC button several times to increase the recording time in:
 - ◆ 30-minute intervals up to four hours
 - ◆ 1-hour intervals up to nine hours (LP)**Result:** The length is displayed on the television displays. The selected programme is recorded for the length of time requested. At the end of that time, the VCR stops recording automatically.
- 8 If you wish to cancel the recording before the end, press VCR STANDBY/ON.

- ✋
- If the end of the tape is reached while recording:
- ◆ The recording stops
 - ◆ The VCR automatically turns off

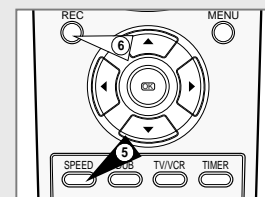
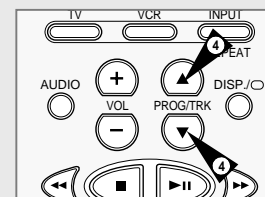
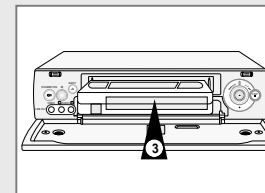

Using the Timer Programming Feature

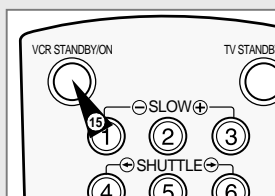
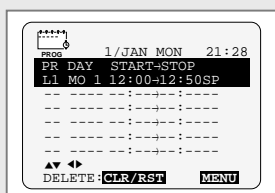
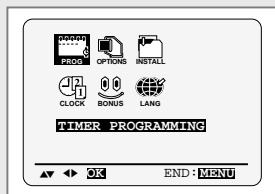
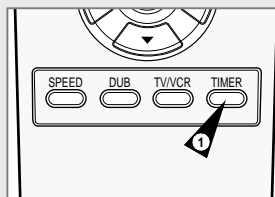

The *Timer Programming* feature allows you to preset the VCR to record a programme up to one month before that programme is to be broadcast. Up to six programmes can be preset.

Before presetting a recording, check that the date and time are correct.

- 1 - Insert the cassette. Press the **TIMER** button or, press **MENU** on the remote control.
Result: The programming menu is displayed.
Press the **OK** button to select **TIMER PROGRAMMING** option.
Result: The **TIMER PROGRAMMING** menu is displayed.
- 2 Press **▶** to select the input source.
- 3 Select the required station by pressing the **▲**, **▼** buttons or **INPUT** to select the **LINE IN 1** or **LINE IN 2** input sources.
- 4 Press **▶** to select the recording day.
- 5 Select the required day by pressing the **▲** or **▼** buttons.
- 6 Press **▶** to select the recording start time.
- 7 Select the required hour value by pressing the **▲** or **▼** buttons.
- 8 Press **▶** to select the minutes.
- 9 Select the required minute value by pressing the **▲** or **▼** buttons.
- 10 Press **▶** to select the recording end time.
- 11 Select the required recording end time by pressing the **▲** or **▼** buttons, following the same procedure as when selecting the recording start time.
- 12 Press **▶** to select the the recording speed (**AUTO/SP/LP**).
- 13 Press the **▲** or **▼** buttons to switch between the **AUTO**, **SP** (Standard Play) or **LP** (Long Play).
- 14 When you have finished, press the **MENU** button.
- 15 Press the **VCR STANDBY/ON** button to activate the timer.
Result: Before starting recording, the VCR compares the timer duration with the remaining time on the cassette.

Auto Tape Speed Select

The VCR's "Auto Tape Speed Select" function compares the duration of the timer recording to the actual recording time remaining on the tape loaded. If there is insufficient tape to complete a timer recording in **AUTO** mode, the VCR automatically switches to **LP** mode to record the whole programme.

E.g. If there is a one hour **AUTO** mode timer recording to be started, but only 40 minutes of tape remaining, the VCR will record in **SP** for 20 minutes and switch to **LP** mode for the remaining 40 minutes.

Checking a Preset Recording

You can check your preset recordings:

- ◆ When you have finished presetting the VCR
- ◆ If you have forgotten which programmes will be recorded

- 1 - Insert the cassette. Press the **TIMER** button or, press **MENU** on the remote control.
Result: The programming menu is displayed.
Press the **OK** button to select **TIMER PROGRAMMING** option.
Result: The **TIMER PROGRAMMING** menu is displayed.
- 2 Press the **▲** or **▼** buttons to select the required programme.
- 3 Press the **◀** or **▶** buttons to select and change any values as required. For more details, refer to the previous page.
- 4 On completion, press **MENU** twice.

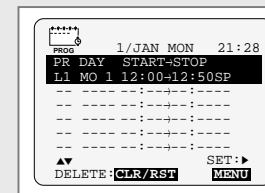

Cancelling a Preset Recording

You can cancel any programmes that are:

- ◆ Incorrect
- ◆ No longer required

- 1 - Insert the cassette. Press the **TIMER** button or, press **MENU** on the remote control.
Result: The programming menu is displayed.
Press the **OK** button to select **TIMER PROGRAMMING** option.
Result: The **TIMER PROGRAMMING** menu is displayed.
- 2 Select the programme to be cancelled by pressing the **▲** or **▼** buttons.
- 3 Press the **CLR/RST** button to cancel the selected programme.
Result: All the recording information is deleted and the broadcast will not be recorded.
- 4 On completion, press **MENU** twice.

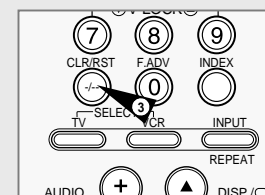
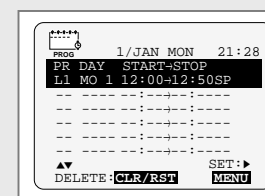

Playing a Cassette

This function allows you to play back any pre-recorded cassette.

- 1 Switch on both the television and your VCR.
 - 2 Insert the video cassette to be played. If the safety tab on the cassette is intact, press ►. Otherwise, the cassette is played automatically.
 - When a cassette is loaded, the tape position is optimized automatically to reduce disturbance (Digital Auto Tracking). When playing a cassette, if the end of the tape is reached, the cassette is rewound automatically. NTSC tapes can be played back but cannot be recorded with this VCR.
- | 3 To... | Then press... |
|--------------------|---------------|
| Stop the playback | ■ (STOP). |
| Eject the cassette | ▲ (EJECT). |

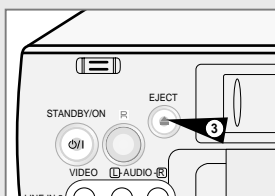
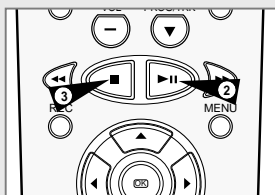

Adjusting Picture Alignment Manually

The Picture Alignment feature allows you to adjust the alignment manually to obtain the best possible picture.

When noise bars or streaks appear during playback, adjust alignment manually by pressing the PROG/TRK (▲ or ▼) buttons until the picture is clear and stable.

- Result:**
- ◆ The tracking bar appears.
 - ◆ The image is adjusted.
 - ◆ The tracking bar disappears when you release the button.

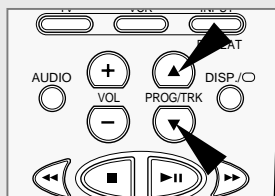

Intelligent Picture Control

The Intelligent Picture Control Feature allows you to adjust the sharpness of the image automatically, according to your own preferences.

- 1 During playback, press the MENU button on the remote control.

Result: The programming menu is displayed.
- 2 Press the corresponding ▲, ▼ or ◀, ▶ buttons to select the **USER SET** option.

Result: The **USER SET** menu is displayed.
- 3 Press the OK button to select this option.

Result: The **USER SET** menu is displayed.
- 4 Press the corresponding ▲ or ▼ buttons, until the **IPC** option is selected.
- 5 Press the ▶ button to select the IPC (intelligent picture control) option.
 - When intelligent picture control mode is **ON**, the sharpness of the image is adjusted automatically.
- 6 To adjust the sharpness manually, press the ▼ button to turn the IPC mode **OFF**.
- 7 Press the ◀ or ▶ buttons until the picture is displayed according to your preferences.
 - If you do not press a button within ten seconds, the **PICTURE** menu disappears automatically.
- 8 On completion, press the MENU button again.

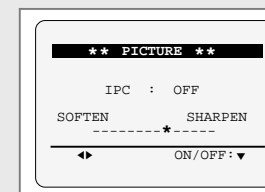
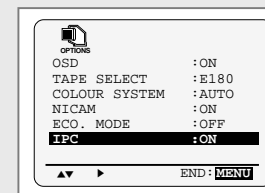
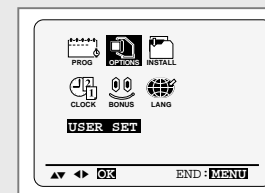

Selecting the Colour Mode

Before recording or playing back a cassette, you can select the required system standard.

- When you playback an NTSC-recorded tape on this VCR make a setting on the colour system according to your TV. If your TV is a PAL system only TV, set NTPB. If your TV is Multi System TV (NTSC 4.43 compatible), set NT4.43 and you can record NT4.43.

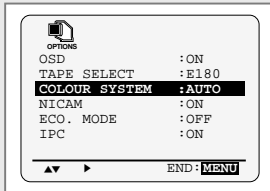
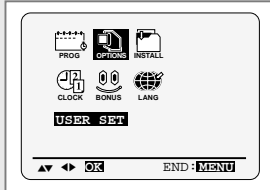

- Press MENU on the remote control.
Result: The programming menu is displayed.
- Press the corresponding ▲, ▼ or ◀, ▶ buttons to select the **USER SET** option.
- Press the OK button to select this option.
Result: The **USER SET** menu is displayed.
- Press the corresponding ▲ or ▼ buttons, until the **COLOUR SYSTEM** option is selected.
- Press the ▶ button to select **AUTO** → **PAL** → **MESECAM** → **B/W** or **NT3.58** → **NT4.43** → **NTPB**.

AUTO	When playing back a cassette, the system standard is automatically selected by the VCR.
B/W	Black and White
- On completion, press MENU twice to exit the menu.

Selecting the Audio Output Mode

When monitoring a TV programme or playing back a Hi-Fi recorded video tape, press the **AUDIO** button to select a desired sound output. As the **AUDIO** button is pressed, the sound output and the indicator change as below:

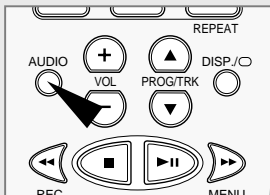

Sound type	Stereo sound	Bilingual sound	Standard sound broadcast
OSD display	Heard in stereo. (left channel and right channel)	Channel I (MAIN) heard from the left speaker, channel II (SUB) heard from the right speaker.	Heard in monaural.
	Left channel heard from both the left and right speakers.	Channel I (MAIN) heard from both the left and the right speakers.	Heard in monaural.
	Right channel heard from both the left and right speakers.	Channel II-(SUB) heard from both the left and the right speakers.	Heard in monaural.
	Sound mixed the left and right channels, and the normal audio track.		
	Heard in monaural.	Channel I (MAIN) heard from both the left and the right speakers.	Heard in monaural.

Playing a Cassette in Slow Motion

You can play a cassette in slow motion.

- No sound is heard when playing back a cassette in slow motion.

- Press:
 - ▶▶ to start playing the cassette
 - SLOW (⊖ SLOW ⊕) as many times as required to decrease or increase the speed respectively
 To return to the normal speed, press the ▶▶ button twice.
- When playing back in slow motion, picture interference may occur. Press the PROG/TRK (▲ or ▼) buttons to minimize this effect.

- When you have been using the Slow Motion function for more than about five minutes, the VCR will automatically play to protect the:
 - Cassette
 - Video heads

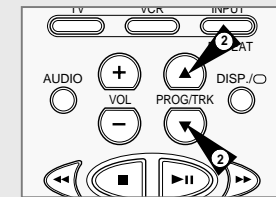
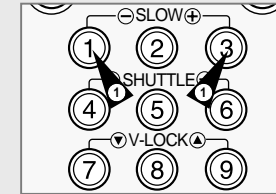

Playing a Sequence Frame by Frame

You can:

- Stop the cassette at a given frame (image)
- Advance one frame at a time

- No sound is heard when playing back frame by frame.

- Press:
 - ▶▶ to start playing the cassette
 - ▶▶ to stop the tape at a given frame
 - F.ADV (⊖ ⊕) to advance frame by frame
- To return to normal playback, press ▶▶.

- When you have been using the Frame-by-Frame function for more than about five minutes, the VCR will automatically play to protect the cassette and video heads.
- Vertical stability: When playing back frame by frame, interference may be seen on the screen. Press the V-LOCK (⊖ V-LOCK ⊕) buttons to minimize this effect.

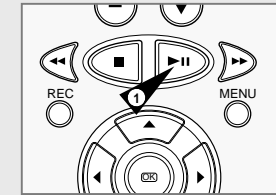

Picture Search, Fast Forward/Rewind

Picture Search enables you to Fast Forward or Rewind and look for a particular part of a tape.

- 1 Press PLAY, the VCR will enter normal play mode. While in play, press and release the ►► (or ◀◀) button. The VCR will search at 5 times the normal playback speed.
- 2 To return to normal playback mode, press the ►|| button.
- 3 If you press and HOLD down the ►► (or ◀◀) button the VCR will search at 9 times the normal speed. Releasing the ►► button will return the VCR to search at 5 times the normal speed. To return to normal playback mode, press the ►|| button.
- 4 Whilst in Picture Search mode, if you press the ►► button again, the VCR will enter normal Fast Forward mode.
- 5 Likewise, whilst in Picture Search ◀◀ mode, if you press the ◀◀ button again, the VCR will enter normal Rewind mode.
- 6 If, when Redwing (◀◀) or Fast Forwarding (►►), you press the ◀◀ (or ►►) button, the VCR will enter the Picture Search mode.

Searching for a Specific Sequence

Each time you record a cassette on this VCR, an "index" is automatically marked on the tape when recording starts.

The Search function allows you to fast-forward or rewind to a specific index and start playback from that point. Depending on the direction selected, the indexes are numbered as follows:

etc.	Prev Seq.	Seq. being played	Next Seq.	etc.
	2	1	1	2

➤ This VCR uses a standard indexing system (VISS). As a result, it will recognize any indexes marked by other VCRs using the same system and vice versa.

INTRO SCAN

- 1 To search for a specific index, press INDEX.
- 2 Press the ◀◀ or ►► buttons depending on the direction where your desired programme is located.
- 3 When an Index mark is found the VCR will playback the tape for 5 seconds, after which it will continue searching for the next Index mark.
- 4 If you want to watch the tape from a particular Index, simply press ►||.

Index Skip Search:

This feature will enable you to fast forward/rewind to a specific point on a tape: E.g. if you have recorded 3 different programmes on a tape and you have rewound the tape to the beginning, by using this feature you can go directly to the start of programme 2 simply by pressing the INDEX button.

- 1 Press the INDEX to start the Index search.
- 2 Press the ◀◀ or ►► buttons twice more. This will take you directly to the start of the desired programme is located.
- 3 These Index searches can be made forwards: (press ►►) or backwards: (press ◀◀).
- 4 To cancel an Index search simply press the ►|| or ■ button.

Auto Repeat Play

You can set repeat play to repeat the tape continuously from beginning to end.

- 1 Press MENU on the remote control.
Result: The programming menu is displayed.
- 2 Press the corresponding ▲, ▼ or ◀, ► buttons to select the **EASY OPERATION** option.
- 3 Press the OK button to select this option.
Result: The **EASY OPERATION** menu is displayed.
- 4 Press the corresponding ▲ or ▼ buttons, until the **REPEAT PLAY** option is selected.
- 5 To... Press ◀ or ►, until...
Repeat play **ON** is displayed.
Do not wish to repeat play **OFF** is displayed.
- 6 On completion, press MENU twice to exit the menu.

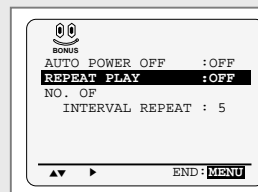

Interval Repeat Play

You can set interval repeat play to repeat the cassette several times for special interval.

- 1 Press MENU on the remote control.
Result: The programming menu is displayed.
- 2 Press the corresponding ▲, ▼ or ◀, ► buttons to select the **EASY OPERATION** option.
- 3 Press the OK button to select this option.
Result: The **EASY OPERATION** menu is displayed.
- 4 Press the corresponding ▲ or ▼ buttons, until the **NO. OF INTERVAL REPEAT** option is selected.
- 5 To... Press ►, until...
Interval repeat play 5, 10, 15 is displayed. (choose repeat time 5 times, 10 times, 15 times)
Cancel interval repeat play **OFF** is displayed.
- 6 On completion, press MENU twice to exit the menu.
- 7 To select interval during playback, press the INPUT/REPEAT button at the desired start point.
Result: "INTERVAL REPEAT SETTING" is displayed. Press the INPUT/REPEAT button one more time at the desired end point.
Result: The tape is automatically rewound to the start point. "INTERVAL REPEAT" is displayed.

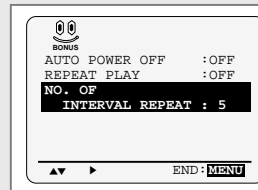

Using the Tape Counter

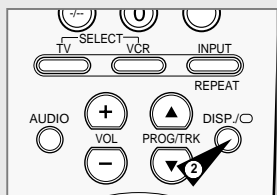
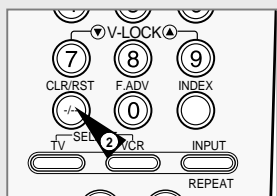
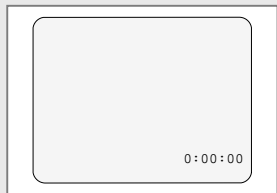

The tape counter:

- ◆ Indicates the elapsed time in the play and record modes (hours, minutes and seconds)
- ◆ Is reset when a cassette is inserted in the VCR
- ◆ Allows you to find the beginning of a sequence easily

➔ If the remaining time is to be calculated correctly, you must indicate the type of cassette being used.

- 1 Insert a cassette in your VCR.
- 2 To set the tape counter to zero at the beginning of a sequence:
 - ◆ Press DISP./O twice to display the counter
 - ◆ Press CLR/RST when you want to set the tape counter to zero
- 3 When you are ready,
 - ◆ Start playback or Recording.
 - ◆ Press the ■ button.
 - ◆ To fast-forward or rewind to the sequence at which the counter was set to zero, press ◀◀ or ▶▶.

➤ Some VCR information, such as the counter, can be displayed on the television screen (unless you have deactivated the OSD mode; refer to page 14).

Press DISP./O:

- ◆ Once to display the current function, programme number, recording speed, date, time and counter
- ◆ Twice to display the counter only
- ◆ Three times to display the time remaining on the cassette
- ◆ Four times to clear the display

Connecting an RCA Audio/Video Input Cable

You can connect other audio/video equipment to your VCR using audio/video cables if the appropriate outputs are available on the equipment chosen.

Examples:

- ◆ You wish to copy a video cassette with the help of a second VCR (see page 34).
- ◆ You wish to play back and/or copy pictures taken with a camcorder (see page 34).

- ➔
- ◆ Regardless of the type of connection chosen, you must always connect the coaxial cable supplied. Otherwise, no picture will be visible on the screen when the VCR is switched off.
 - ◆ Make sure that both the television and the VCR are switched off before connecting the cables.

- 1 Connect one end of the RCA audio/video cable into the VIDEO INPUT socket on the front of the VCR.
- 2 Plug the other end of the audio/video cable into the appropriate output connector on the other system (VCR or camcorder).
- 3 Connect one end of the RCA audio cable supplied into the AUDIO INPUT sockets on the front of the VCR.
 - Take care to respect the colour coding of the left and right channels.
- 4 Plug the other end of the audio cable into the appropriate output connectors on the other system (VCR, camcorder or Hi-Fi sound system).

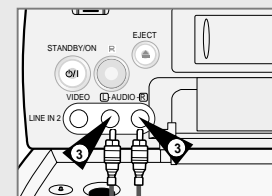
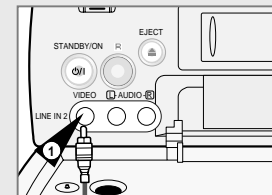

Using the Assemble Edit Function

This function allows you to start a new recording at a specific position on the cassette while maintaining a very smooth scene change.

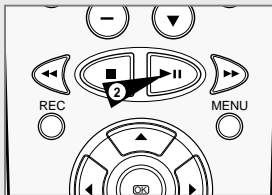

- 1 Insert the cassette to be edited in your VCR.
- 2 Press the ►|| button to start playback.
- 3 When you reach the position from which you wish to start the new recording, press the ►|| button.
- 4 Press the F.ADV (⊙) button again as often as necessary to advance frame by frame, until the exact recording position is located.
- 5 While the VCR is in still mode, hold the REC button down for a while to activate the Assemble Edit function.
Result: Record symbol flashes in the display.
- 6 Select the source from which you wish to record by pressing:
 - ◆ The PROG/TRK (▲ or ▼) buttons for television channels
 - ◆ The INPUT button for the LINE IN 1 or LINE IN 2 input sources
- 7 Press the ►|| button to start recording.
- 8 When you have finished recording, press ■.

Recording from Another VCR or Camcorder

You can copy a cassette to your VCR from another video source, such as another VCR or a camcorder.

It is an infringement of copyright laws to copy prerecorded cassettes or to re-record them in any form without the permission of the owners of the corresponding copyright.

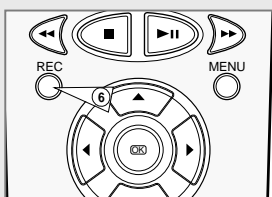
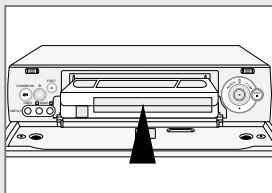

- 1 Connect the VCR, from which the cassette is to be copied, to the appropriate RCA audio and video input connectors on the rear of your VCR, as indicated on page 10. You can also use an RCA audio and video cable to connect the LINE IN 2 input on the front of your VCR.
- 2 Insert a blank cassette in your VCR.
- 3 Insert the pre-recorded cassette in the other video source (VCR or camcorder).
- 4 Press the INPUT button to select the appropriate input on your VCR:
 - ◆ LINE IN 1 for the rear input
 - ◆ LINE IN 2 for the front input
- 5 Start playing back the cassette to be copied.
- 6 Hold REC down for a while to start recording on your VCR.
- 7 When you have finished recording, press ■ on both VCRs.

- If you wish to view the cassette being copied:
 - ◆ Your VCR must be connected as usual to the television (see page 9 for further details)

Using the TV Buttons on the Remote Control

Your VCR remote control will work with Samsung televisions and compatible brands.

To determine whether your television is compatible, follow the instructions below.

- 1 Switch your television on.
- 2 Point the remote control towards the television.
- 3 Hold down the TV button and enter the two-figure code corresponding to the brand of your television, by pressing the appropriate numeric buttons.

Brand	Codes	Brand	Codes
SAMSUNG	01 to 06	PHILIPS	02, 20, 22
AKAI	09, 23	SABA	13, 14, 22 to 24
GRUNDIG	09, 17, 21	SONY	15, 16
LOEWE	02	THOMSON	13, 14, 24
PANASONIC	08, 23 to 27	TOSHIBA	07, 16 to 19, 21

Result: If your television is compatible with the remote control, it will switch off. It is now programmed to operate with the remote control.

- If several codes are indicated for your television brand, try each one in turn until you find one that works.

When you change the batteries in the remote control, you must reprogramme the code, following the same procedure.

You can then control the television using the following buttons.

Button	Function
TV STANDBY/ON ①	Used to switch the television on and off.
TV or VCR ②	Used to switch between the TV and VCR modes. Only the VOL (+ or -) and TV STANDBY/ON buttons are operational in VCR mode.
-/- ③	Used to enter a two-figure programme number. Example: For programme 12, press -/- followed by numeric buttons 1 and 2.
INPUT ④	Used to select an external source.
VOL + or - ⑤	Used to adjust the volume of the television.
PROG/TRK (▲ or ▼) ⑥	Used to select the required programme.
DISP./O ⑦	Used to switch between an external source and the television tuner.

- The various functions will not necessarily work on all televisions. If you encounter problems, operate the television directly.

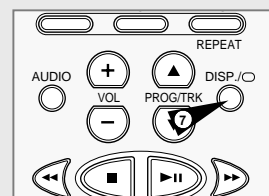
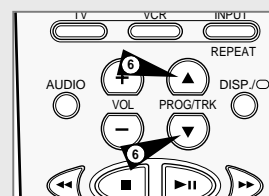
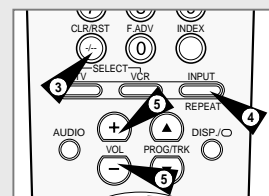
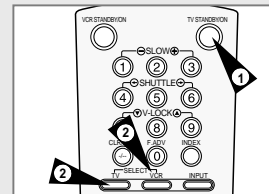

Auto Power Off

The Auto Power Off feature automatically turns off your VCR if no signal is received and you do not press any button for the selected time.

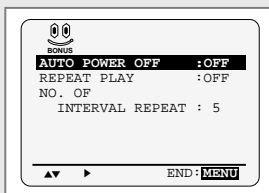

- 1 Press MENU on the remote control.
Result: The programming menu is displayed.
- 2 Press the corresponding ▲, ▼ or ◀, ▶ buttons to select the **EASY OPERATION** option.
- 3 Press the OK button to select this option.
Result: The **EASY OPERATION** menu is displayed.
- 4 Press the corresponding ▲ or ▼ buttons, until the **AUTO POWER OFF** option is selected.
- 5 Press the ▶ button, until you select the time of Auto Power off interval.

OFF	→	2HOUR	→	3HOUR
-----	---	-------	---	-------
- 6 On completion, press MENU twice to exit the menu.

ECO Mode-Reducing Standby power consumption

Low Power Mode reduces the Standby power consumption of the VCR when in Standby mode.
Useful, for example, when you are away from the house on holiday. It saves actually turning the VCR off.

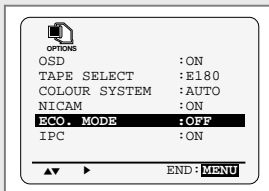
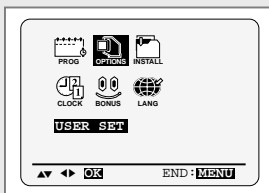

- 1 Press MENU on the remote control.
Result: The programming menu is displayed.
- 2 Press the corresponding ▲, ▼ or ◀, ▶ buttons to select the **USER SET** option.
- 3 Press the OK button to select this option.
Result: The **USER SET** menu is displayed.
- 4 Press the corresponding ▲ or ▼ buttons, until the **ECO MODE** is selected.
- 5 Press the ▶ button to turn LOW(3Watts) mode on. Now, when the VCR is standby mode the front display panel will shut off. Even the clock disappears. By pressing the VCR STANDBY/ON button again the display panel will reappear.
- 6 On completion, press MENU twice to exit the menu.

Technical Specifications

Design and specifications are subject to change without notice.

Format	VHS PAL/NTSC standard	
Heads	Video: 4 rotary heads Hi-Fi audio: 2 rotary heads Audio/Control: 1 stationary head Erase: 1 full track erase head	
Receiving channel	VHF-I, VHF-III, UHF, Interband/Hyperband	
Television system	STANDARD B/G-D/K A2/NICAM STEREO	
Luminance	FM azimuth recording	
Colour system	PAL/MESECAM/NTSC: Down converted subcarrier phase shifted direct recording	
Tape speed	NTSC PB on PAL TV <PAL/MESECAM>	<NTSC>
	SP 23.39 mm/sec	SP 33.35 mm/sec
	LP 11.69 mm/sec	SLP 11.12 mm/sec
	<PAL/MESECAM>	<NTSC>
Recording/playback time	SP 3 hours (E-180 Tape)	SP 2 hours (T-120 Tape)
	LP 6 hours (E-180 Tape)	SLP 6 hours (T-180 Tape)
REW time	About 60 sec in REW with E-180	
VIDEO		
Input	0.5 to 2.0 Vp-p; 75 ohm unbalanced	
Output	1.0 ± 0.2 Vp-p; 75 ohm unbalanced	
Signal-to-noise ratio	Better than 43 dB (SP)	
Horizontal resolution	More than 240 lines (SP)	
AUDIO		
Input	-8 dBm, 47 Kohm unbalanced	
Output	-8 ± 3 dBm, 1 Kohm unbalanced	
Wow and flutter (WTD)	0.4% max (SP)	
Signal-to-noise ratio	68 dB min (IHF A filter)	
Frequency response	20Hz - 20kHz	
Power requirement	AC 100-240V 50/60 Hz	
Power consumption	Approx. 17 watts	
Operation temperature	41°F-104°F (5°C-40°C)	
Operation humidity	10%-75%	
Weight	3.3 Kg (net)	
Dimensions (WxHxD)	360 x 94 x 287 mm	

Problems and Solutions

Before contacting the Samsung after-sales service, perform the following simple checks.

Problem	Explanation/Solution
No power	<ul style="list-style-type: none"> Check that the power plug is connected to a wall outlet. Have you pressed the VCR STANDBY/ON button?
You cannot insert a video cassette	<ul style="list-style-type: none"> A video cassette can only be inserted with the window side up and the safety tab facing you.
The television programme was not recorded	<ul style="list-style-type: none"> Check the VCR aerial connections. Is the VCR tuner properly set? Check if the safety tab is intact on the cassette.
Timer recording was unsuccessful	<ul style="list-style-type: none"> Was the VCR STANDBY/ON button pressed to activate the timer? Re-check the recording start/stop time settings. If there was a power failure or interruption during timer recording, the recording will have been cancelled.
No playback picture or the picture is distorted	<ul style="list-style-type: none"> Check to see if you are using a prerecorded tape.
You cannot see normal broadcasts	<ul style="list-style-type: none"> Check the TUNER/EXTERNAL setting. It should be on TUNER. Check the TV/VCR aerial connections.
Noise bars or streaks on playback	<ul style="list-style-type: none"> Press the PROG/TRK (▲ or ▼) buttons to minimize this effect.
When the ► button is pressed during playback, the still picture has severe "noise bars" streaks	<ul style="list-style-type: none"> A still picture may have "noise bars", depending on the condition of the tape. Press the PROG/TRK (▲ or ▼) buttons during SLOW motion to minimize this effect.
Video Head Cleaning	<ul style="list-style-type: none"> If poor pictures appear on a variety of cassettes, the video heads may need cleaning. This is not a common problem and unless it appears, the heads should not be cleaned. When cleaning the video heads, read all instructions provided with the head cleaning cassette. Incorrect head cleaning can permanently damage the video heads.
If when tuning in your TV to the VCR test pattern your TV does not find the test pattern or the pattern when found suffers from interference, it may be due to the VCR output channel clashing with the normal TV transmissions in your area. To prevent this you will need to change the VCR output channel in the following way	<ol style="list-style-type: none"> Remove the aerial input plug from the socket marked (aerial symbol) on the rear of the VCR. Carry out the instructions "Tuning Your Television for the VCR" (see page 12). Carry out the instructions "Setting the VCR output Channel" (see page 15), move the channel number several channels down from the original setting. (example: from 36 to 33). Replace the aerial plug into the socket marked (aerial symbol) on the rear of the VCR. Re-tune your TV to the VCR again by following instructions "Tuning Your Television for the VCR" (page 12). If the problem still exists repeat steps 1 to 5 moving several more channels away from the original setting.

If you are unable to solve the problem after reading the above instructions, note:

- The model and serial number on the rear of your VCR
- The warranty information
- A clear description of the problem

Then contact your nearest SAMSUNG after-sales service.

TV Frequency Table (System B/G-D/K)

002-012 :CCIR STD VHF 244-250 :MOROCCO
 013-020 :ITALY 251-255 :BELGUIM
 021-069 :CCIR STD UHF
 071-075 :CCIR CABLE
 201-241 :CCIR STD CABLE

DISP	CH	Band	Fp	STD	DISP	CH	Band	Fp	STD	DISP	CH	Band	Fp	STD
002	E02	V-L	48.25	CCIR	060	E60	UHF	783.25	CCIR	151	01	V-L	43.25	Angola
003	E03	V-L	55.25	CCIR	061	E61	UHF	791.25	CCIR	152	02	V-L	52.25	Angola
004	E04	V-L	62.25	CCIR	062	E62	UHF	799.25	CCIR	153	03	V-L	60.25	Angola
005	E05	V-H	175.25	CCIR	063	E63	UHF	807.25	CCIR	154	04	V-H	175.25	S/Afr
006	E06	V-H	182.25	CCIR	064	E64	UHF	815.25	CCIR	155	05	V-H	183.25	S/Afr
007	E07	V-H	189.25	CCIR	065	E65	UHF	823.25	CCIR	156	06	V-H	191.25	S/Afr
008	E08	V-H	196.25	CCIR	066	E66	UHF	831.25	CCIR	157	07	V-H	199.25	S/Afr
009	E09	V-H	203.25	CCIR	067	E67	UHF	839.25	CCIR	158	08	V-H	207.25	S/Afr
010	E10	V-H	210.25	CCIR	068	E68	UHF	847.25	CCIR	159	09	V-H	215.25	S/Afr
011	E11	V-H	217.25	CCIR	069	E69	UHF	855.25	CCIR	160	10	V-H	223.25	S/Afr
012	E12	V-L	224.25	CCIR	071	X	V-L	69.25	CCIR	161	11	V-H	231.25	S/Afr
013	A	V-L	53.75	Italy	072	Y	V-L	76.25	CCIR	162	13	V-H	247.45	S/Afr
014	B	V-L	62.25	Italy	073	Z	V-L	83.25	CCIR	201	R1	V-L	49.75	OIRT
015	C	V-L	82.25	Italy	074	Z+1	V-L	90.25	CCIR	202	R2	V-L	59.25	OIRT
016	D	V-H	175.25	Italy	075	Z+2	V-L	97.25	CCIR	203	R3	V-L	77.25	OIRT
017	E	V-H	183.25	Italy	101	S01	V-L	105.25	CCIR	204	R4	V-L	85.25	OIRT
018	F	V-H	192.25	Italy	102	S02	V-L	112.25	CCIR	205	R5	V-L	93.25	OIRT
019	G	V-H	201.25	Italy	103	S03	V-L	119.25	CCIR	206	R6	V-H	175.25	OIRT
020	H	V-H	210.25	Italy	104	S04	V-L	126.25	CCIR	207	R7	V-H	183.25	OIRT
021	E21	UHF	471.25	CCIR	105	S05	V-L	133.25	CCIR	208	R8	V-H	191.25	OIRT
022	E22	UHF	479.25	CCIR	106	S06	V-L	140.25	CCIR	209	R9	V-H	199.25	OIRT
023	E23	UHF	487.25	CCIR	107	S07	V-H	147.25	CCIR	210	R10	V-H	207.25	OIRT
024	E24	UHF	495.25	CCIR	108	S08	V-H	154.25	CCIR	211	R11	V-H	215.25	OIRT
025	E25	UHF	503.25	CCIR	109	S09	V-H	161.25	CCIR	212	R12	V-H	223.25	OIRT
026	E26	UHF	511.25	CCIR	110	S10	V-H	168.25	CCIR	244	M4	V-H	163.25	Morocco
027	E27	UHF	519.25	CCIR	111	S11	V-H	231.25	CCIR	245	M5	V-H	171.25	Morocco
028	E28	UHF	527.25	CCIR	112	S12	V-H	238.25	CCIR	246	M6	V-H	179.25	Morocco
029	E29	UHF	535.25	CCIR	113	S13	V-H	245.25	CCIR	247	M7	V-H	187.25	Morocco
030	E30	UHF	543.25	CCIR	114	S14	V-H	252.25	CCIR	248	M8	V-H	195.25	Morocco
031	E31	UHF	551.25	CCIR	115	S15	V-H	259.25	CCIR	249	M9	V-H	203.25	Morocco
032	E32	UHF	559.25	CCIR	116	S16	V-H	266.25	CCIR	250	M10	V-H	211.25	Morocco
033	E33	UHF	567.25	CCIR	117	S17	V-H	273.25	CCIR	251	U1	V-H	226.25	Belguim
034	E34	UHF	575.25	CCIR	118	S18	V-H	280.25	CCIR	252	U2	V-H	234.25	Belguim
035	E35	UHF	583.25	CCIR	119	S19	V-H	287.25	CCIR	253	U3	V-H	242.25	Belguim
036	E36	UHF	591.25	CCIR	120	S20	V-H	294.25	CCIR	254	U4	V-H	250.25	Belguim
037	E37	UHF	599.25	CCIR	121	S21	V-H	303.25	CCIR	255	U5	V-H	258.25	Belguim
038	E38	UHF	607.25	CCIR	122	S22	V-H	311.25	CCIR					
039	E39	UHF	615.25	CCIR	123	S23	V-H	319.25	CCIR					
040	E40	UHF	623.25	CCIR	124	S24	V-H	327.25	CCIR					
041	E41	UHF	631.25	CCIR	125	S25	V-H	335.25	CCIR					
042	E42	UHF	639.25	CCIR	126	S26	V-H	343.25	CCIR					
043	E43	UHF	647.25	CCIR	127	S27	V-H	351.25	CCIR					
044	E44	UHF	655.25	CCIR	128	S28	V-H	359.25	CCIR					
045	E45	UHF	663.25	CCIR	129	S29	V-H	367.25	CCIR					
046	E46	UHF	671.25	CCIR	130	S30	V-H	375.25	CCIR					
047	E47	UHF	679.25	CCIR	131	S31	V-H	383.25	CCIR					
048	E48	UHF	687.25	CCIR	132	S32	V-H	391.25	CCIR					
049	E49	UHF	695.25	CCIR	133	S33	V-H	399.25	CCIR					
050	E50	UHF	703.25	CCIR	134	S34	V-H	407.25	CCIR					
051	E51	UHF	711.25	CCIR	135	S35	V-H	415.25	CCIR					
052	E52	UHF	719.25	CCIR	136	S36	V-H	423.25	CCIR					
053	E53	UHF	727.25	CCIR	137	S37	UHF	431.25	CCIR					
054	E54	UHF	735.25	CCIR	138	S38	UHF	439.25	CCIR					
055	E55	UHF	743.25	CCIR	139	S39	UHF	447.25	CCIR					
056	E56	UHF	751.25	CCIR	140	S40	UHF	455.25	CCIR					
057	E57	UHF	759.25	CCIR	141	S41	UHF	463.25	CCIR					
058	E58	UHF	767.25	CCIR	142	1A	V-L	42.25	Indoesia					
059	E59	UHF	775.25	CCIR	143	01	V-L	45.25	Nez					

THIS APPLIANCE IS DISTRIBUTED BY

