

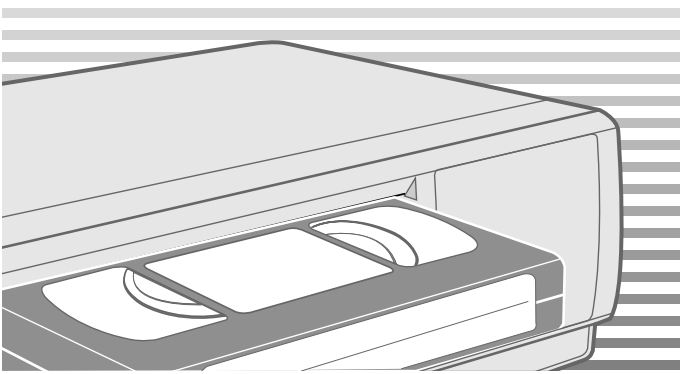

**VIDEO
CASSETTE RECORDER
SV-650GS
SV-455G
SV-455GS
SV-254G
SV-254GS**

Instruction Manual



About this manual

Thank you for purchasing a Samsung Video Cassette Recorder (VCR). Your Owner's Instructions contain much valuable information on setting up and using your VCR. Please take the time to read them as they will help you take full advantage of your VCR's features.

The instructions in this manual are for models, SV-650GS, SV-455G, SV-455GS, SV-254G and SV-254GS.

Before you start reading this manual please check your model number.

It is displayed on the rear of the VCR.

- ★(SV-650GS): Exceptions only for a certain model, for example SV-650GS.

- Gray shaded areas marked with a star indicate instructions that are only relevant to one model.

Features Chart

Feature	SV-650GS	SV-455G SV-455GS	SV-254G SV-254GS
IPC (Intelligent Picture Control)	●	●	●
Changing recording speed (SP/LP)	●	●	●
Connecting an RCA Audio/Video cable	●	●	●
Dual VCR/TV remote Control	●	●	
Front SHUTTLE		●	
Hi-Fi	●		
A2/NICAM	●		
Audio Dubbing a pre-recorded cassette	●		

Contents

◆ FOREWORD	
■ Safety Instructions	5
◆ VCR OVERVIEWS	
■ Front View of the VCR	6
■ Rear View of the VCR	7
■ Infrared Remote Control	8
■ Display Indicator	9
■ Accessories	9
◆ CONNECTING YOUR VIDEO CASSETTE RECORDER	
■ Deciding How to Connect Your VCR	10
■ Connecting Your VCR to the TV using the Coaxial Cable	11
■ Connecting Your VCR to the TV using the RCA Cable	11
■ Connecting Other Equipment to Your VCR	12
■ Plug & Auto Set Up	13
■ Tuning your Television for the VCR	14
◆ SETTING UP YOUR VIDEO CASSETTE RECORDER	
■ Inserting Batteries in the Remote Control	15
■ Setting the Date and Time	15
■ Displaying/Hiding On-Screen Information	16
■ Choosing Your Language	16
■ Setting the VCR Output Channel	17
■ Selecting the RF OUT sound Mode	17
■ Presetting the Stations Automatically	18
■ Presetting the Stations Manually	19
■ Clearing a Preset Station	20
■ Changing the Preset Station Table	21
◆ RECORDING TELEVISION BROADCASTS	
■ Selecting the Cassette Type	22
■ Selecting the Recording Speed	22
■ Protecting a Recorded Cassette	23
■ Recording a Programme Immediately	23
■ Recording a Programme with Automatic Stop	24
■ Using the Timer Programming Feature	25
■ Checking a Preset Recording	26
■ Cancelling a Preset Recording	26

- ◆ **PLAYING BACK**
 - Playing a Cassette..... 27
 - Adjusting Picture Alignment Automatically (SV-254G/SV-254GS Only) 27
 - Adjusting Picture Alignment Manually 27
 - Intelligent Picture Control 28
 - Intelligent Picture Control (SV-254G/SV-254GS Only)..... 28
 - Selecting the Colour Mode 29
 - Selecting the Audio Output Mode (SV-650GS Only)..... 30
 - Selecting the Audio Mute Mode (SV-455G/SV-455GS/SV-254G/SV-254GS Only)..... 30
- ◆ **SEARCHING FOR A SEQUENCE**
 - Playing a Cassette in Slow Motion (SV-650GS/SV-455G/SV-455GS Only) . 31
 - Playing a Sequence Frame by Frame 31
 - Picture Search, Fast Forward/Rewind 32
 - Playing a Sequence at Variable Speeds 32
 - Searching for a Specific Sequence 33
 - Auto Repeat Play 34
 - Interval Repeat Play 34
 - Using the Tape Counter 35
- ◆ **ADVANCED RECORDING FEATURES**
 - Connecting RCA Audio/Video Input Cable 36
 - Using the Assemble Edit Function..... 37
 - Recording from Another VCR or Camcorder 37
 - Audio Dubbing a Pre-recorded Cassette (SV-650GS Only)..... 38
- ◆ **OTHER FUNCTIONS AND USEFUL RECOMMENDATIONS**
 - Using the TV Buttons on the Remote Control (SV-650GS/SV-455G/SV-455GS Only)..... 39
 - Auto Power Off 40
 - Technical Specifications 41
- ◆ **SOLVING PROBLEMS**
 - Problems and Solutions..... 42
 - TV Frequency Table..... 43

Symbols

- 
 Press/push
 - 
 Hold down
 - 
 Important
 - 
 Note
 - 
 Option
- ① = Step number

The following illustrations represent precautions.



The lightning bolt is a warning sign alerting you to dangerous voltage inside the product. DO NOT OPEN THE VCR. Refer to service personnel.

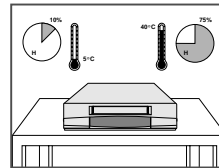

Do NOT expose the VCR to extreme temperature conditions (below 5°C and above 40°C) or to extreme humidity conditions (less than 10% and more than 75%).

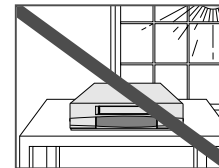

Do NOT expose the VCR to direct sunlight.

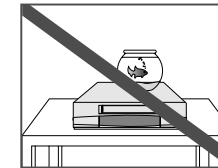

Do NOT expose the VCR to any liquids.

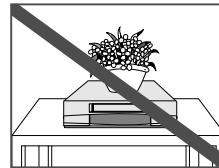

Do NOT place any objects on the VCR or remote control.

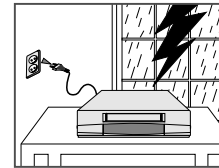

During a storm and/or lightning, unplug the VCR from the mains socket and aerial.

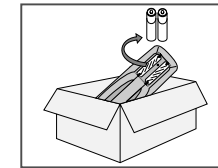

If the remote control is not used for a long period of time, remove the batteries and store it in a cool, dry place.

THIS DEVICE IS NOT FOR USE IN INDUSTRIAL ENVIRONMENTS

Front View of the VCR

(SV-650GS)

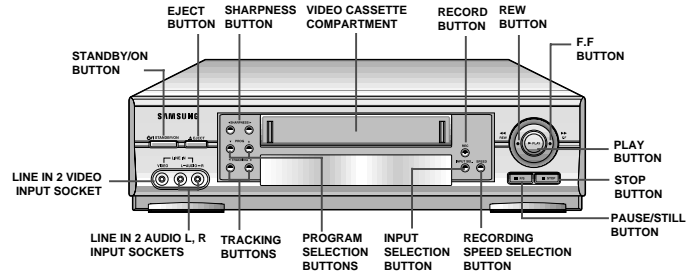

(SV-455G/SV-455GS)

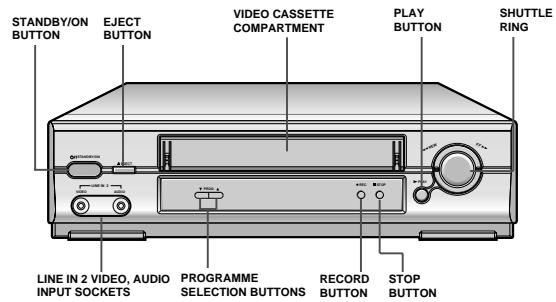

(SV-254G/SV-254GS)

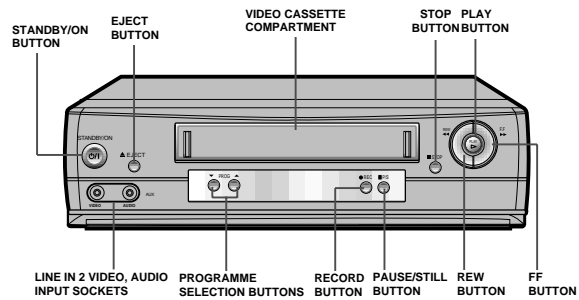

Rear View of the VCR

(SV-650G)

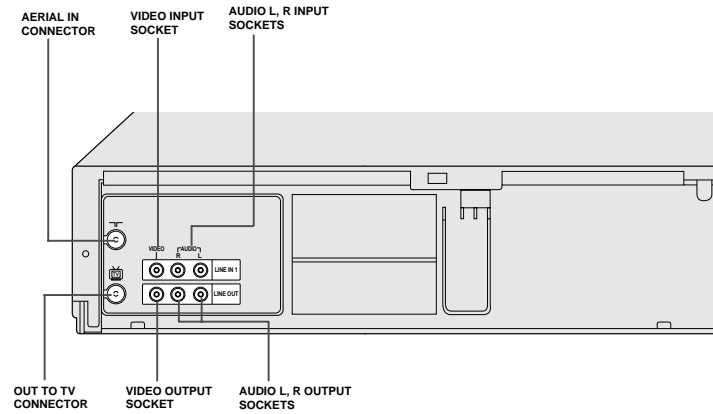

(SV-455G/SV-455GS/SV-254G/SV-254GS)

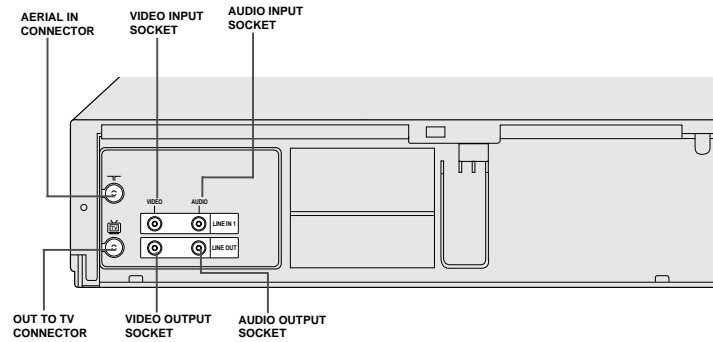

Infrared Remote Control

(SV-655GS/SV-455G/SV-455GS)

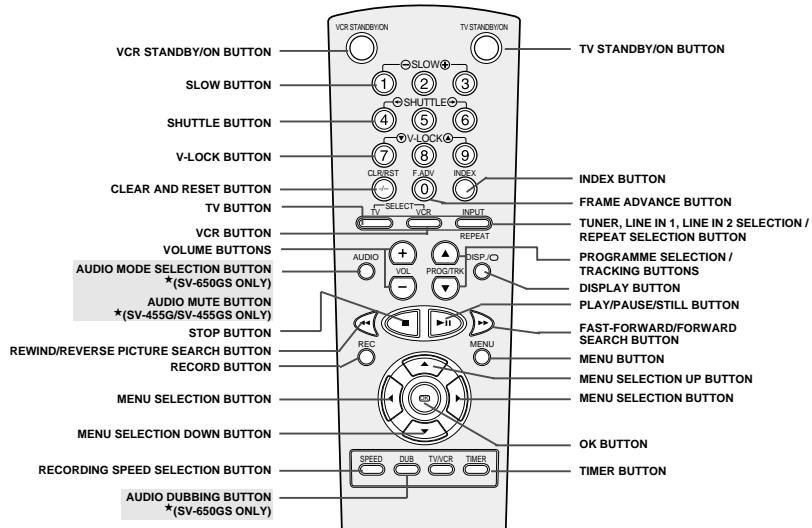

Display Indicator

(SV-650GS)

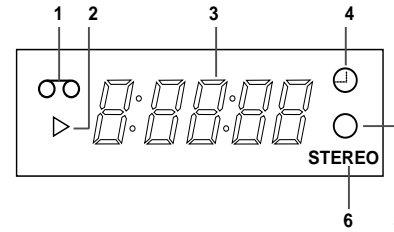

(SV-455G/SV-455GS/SV-254G/SV-254GS)

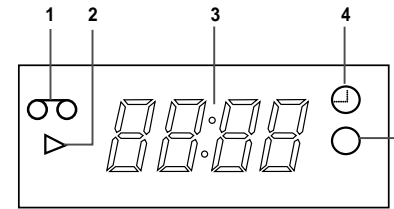

- 1 Cassette loaded indicator
- 2 PLAY indicator
- 3 Multi-function display
- 4 Timer indicator
- 5 REC indicator
- 6 STEREO indicator

(SV-254G/SV-254GS)

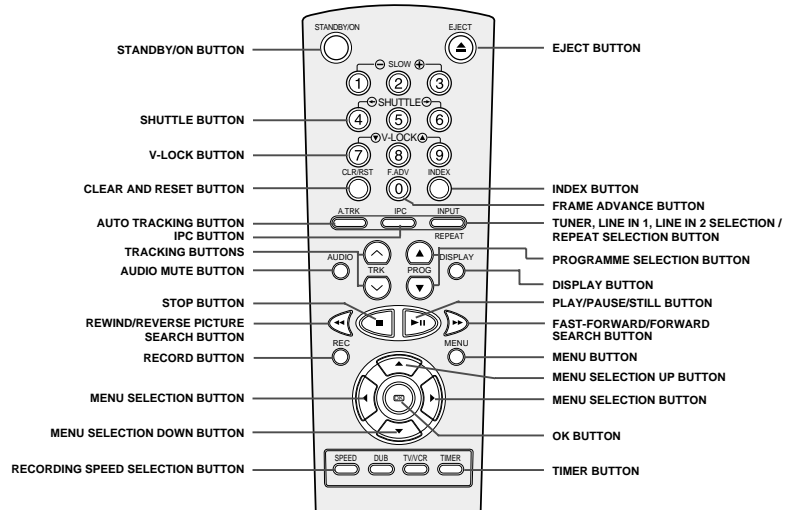

Accessories

You have just purchased a SAMSUNG Video Cassette Recorder (VCR). Together with your VCR, you will find the following accessories in the box.

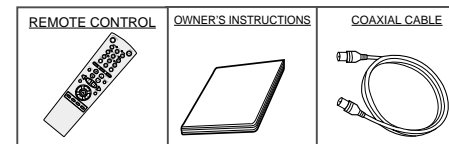

Deciding How to Connect Your VCR

You must take into account various factors when connecting audio or video systems:

- ◆ Types of connectors available on your systems
- ◆ Systems connected permanently to the VCR (satellite receiver for example) or temporarily (camcorder for example)

Your VCR is equipped with the following connectors.

Connector	Location	Type	Direction	Recommended Use
LINE IN 1	Rear		Audio/Video RCA In	<ul style="list-style-type: none"> ◆ Satellite receiver ◆ Television ◆ Other VCR
LINE IN 2	Front		Audio/Video RCA In	<ul style="list-style-type: none"> ◆ Audio system ◆ Camcorder
Audio/Video output	Rear		Audio/Video RCA Out	<ul style="list-style-type: none"> ◆ Television ◆ Other VCR ◆ Audio system
OUT TO TV	Rear	75 Ω coaxial	Out	◆ Television
IN FROM ANT.	Rear	75 Ω coaxial	In	<ul style="list-style-type: none"> ◆ Aerial ◆ Cable television network ◆ Satellite receiver

Whenever you connect an audio or video system to your VCR, ensure that all elements are switched off.

Refer to the documentation supplied with your equipment for detailed connection instructions and associated safety precautions.

Connecting Your VCR to the TV using the Coaxial Cable

To receive television programmes a signal must be received from one of the following sources:

- ◆ An outdoor aerial
- ◆ An indoor aerial
- ◆ A cable television network
- ◆ A satellite receiver

Make sure that both the television and the VCR are switched off before connecting the cables.

- 1 Remove the aerial or network input cable from the television.
- 2 Connect this cable to the 75Ω coaxial socket marked on the rear of your VCR.
- 3 Plug the coaxial cable supplied into the socket on your VCR.
- 4 Plug the other end of the coaxial cable into the connector previously used for the aerial on the television.
- 5 To obtain better quality pictures and sound on your television, you can also connect your VCR to the television via the RCA cable (see section below) if your television is equipped with this type of connection.

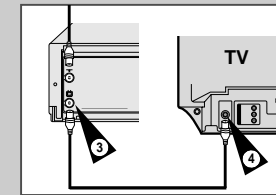
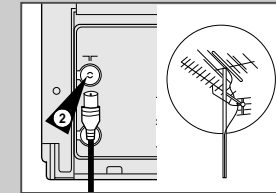

Connecting Your VCR to the TV using the RCA Cable

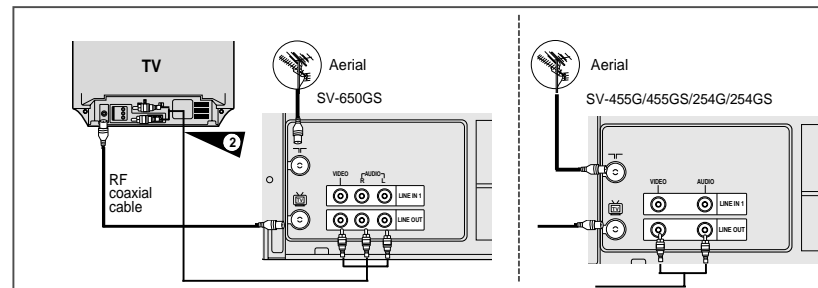

You can connect your VCR to the television using the RCA cable if the appropriate input is available on the television. You thus:

- ◆ Obtain better quality sound and pictures
- ◆ Simplify the setting up procedure of your VCR

Regardless of the type of connection chosen, you must always connect the coaxial cable supplied. Otherwise, no picture will be visible on the screen when the VCR is switched off. Make sure that both the television and the VCR are switched off before connecting the cables.

- 1 Connect the coaxial cable as indicated in the above section.
- 2 Connect one end of the RCA Audio/Video cable to the Video output and Audio output socket on the rear of the VCR.
- 3 Plug the other end into the appropriate connector on the television.

Connecting Other Equipment to Your VCR

You can connect other audio and/or video equipment to your VCR in different ways. The following illustrations give a few examples of the connection possibilities.

➤ The RCA input/output connectors on the front of the VCR are used for equipment, such as camcorders, VCRs or sound systems.

SV-650GS

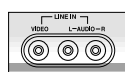

FRONT OF THE VCR

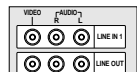

REAR OF THE VCR

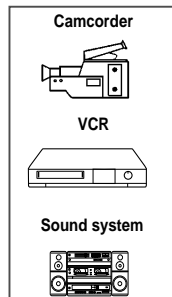
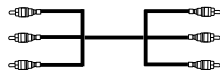

SV-455G/SV-455GS/SV-254G/SV-254GS



FRONT OF THE VCR

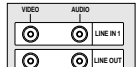

REAR OF THE VCR

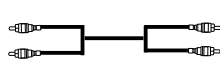

Plug & Auto Set Up

Your VCR will automatically set itself up when it is plugged into the mains for the first time. TV stations will be stored in memory. The process takes a few minutes. Your VCR will then be ready for use.

- 1 Connect the coaxial cable as indicated on page 11.
(Connecting Your VCR to the TV Using the Coaxial Cable)
- 2 Plug the VCR into the mains.
Result: The **LANGUAGE SET** menu is displayed.
- 3 Select the required language by pressing the **▲** or **▼** buttons.
- 4 Press OK to store the language selected.
Result: A message appears.
- 5 Press OK to start the auto scanning.
◆ The number of stations automatically stored by the VCR depends on the number of stations that it has found.
- 6 On completion, press MENU twice to exit the menu.

➤ ◆ Auto preset can be performed by pressing (STOP) on the VCR continuously for 5 seconds or more with no tape inserted.

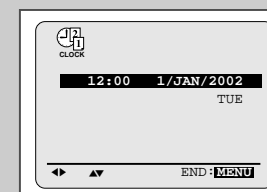
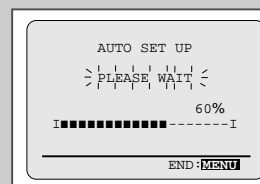
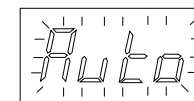
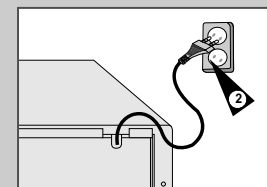
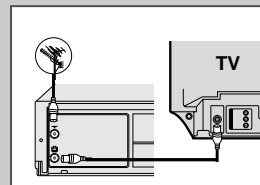

Tuning Your Television for the VCR

★(SV-650GS/SV-455G/SV-455GS) ★(SV-254G/SV-254GS)

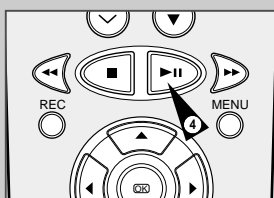
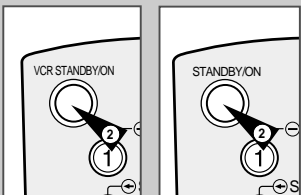

You must tune your television for the VCR only if you are not using a RCA cable

➤ To view pictures from your VCR when a RCA cable is used, the television must be set to the audio/video mode (AV).

- 1 Switch on the television.
- 2 Switch on the VCR by pressing STANDBY/ON on the front of the VCR or VCR STANDBY/ON (STANDBY/ON) on the remote control.
- 3 Select a programme position on the television to be reserved for use with your VCR.
- 4 Insert the video cassette in the VCR. Check that the VCR starts reading the cassette; if not, press ►|| button.
- 5 Start a scan on your television or set the television to UHF channel 36.
- 6 Fine tune the television until the pictures and sound are obtained clearly.
- 7 If you cannot find the pictures and sound, or there is interference from nearby channels, it may be necessary to change the setting of the VCR output channel (see Setting the VCR Output Channel on page 17 and Problems and Solutions on page 42).
- 8 When the picture and sound are perfectly clear, store this channel at the desired programme position on the television.
Result: That programme is now reserved for use with your VCR.

Inserting Batteries in the Remote Control

You must insert or replace the batteries in the remote control when you:

- ◆ Purchase the video cassette recorder
- ◆ Find that the remote control is no longer working correctly

- 1 Push the tab in the direction of the arrow to release the battery compartment cover on the rear of the remote control.
- 2 Insert two AA, R6 or equivalent batteries, taking care to respect the polarities:
 - ◆ + on the battery with + on the remote control
 - ◆ - on the battery with - on the remote control
- 3 Replace the cover by aligning it with the base of the remote control and pushing it back into place.

➤ Do not mix different battery types (manganese and alkaline for example).

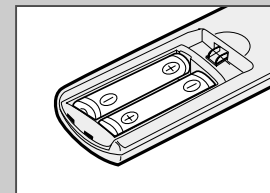
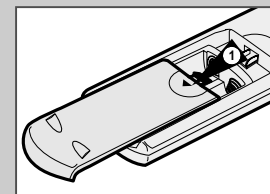

Setting the Date and Time

Your VCR contains a 24-hour clock and calendar used to:

- ◆ Automatically stop programme recording
- ◆ Preset your VCR to record a programme automatically

You must set the date and time when:

- ◆ You purchase the video cassette recorder
- ◆ The power supply remains off for more than 1 hour
★(SV-650GS only)
- ◆ The power supply remains off for more than 30 sec
★(SV-455G/SV-455GS/SV-254G/SV-254GS only)

☞ Do not forget to reset the time when you change clocks from winter to summer time and vice versa.

- 1 Press MENU on the remote control.
Result: The programming menu is displayed.
- 2 Press the corresponding ▲, ▼ or ◀, ▶ buttons to select the CLOCK SET option.
Result: The CLOCK SET menu is displayed.
- 3 Press the OK button to select this option.
Result: The CLOCK SET menu is displayed.
- 4 Press ◀ or ▶ to select the hour, minutes, day, month and year.
Result: The option selected flashes.
- 5 Press the ▲ or ▼ buttons to increase or decrease the value.
Result: The day of the week is displayed automatically.
 - You can hold the ▲ or ▼ buttons down to scroll more quickly through the values.
- 6 On completion, press MENU twice to exit the menu.

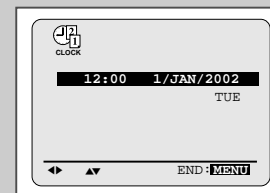
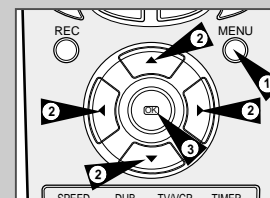

Displaying/Hiding On-Screen Information

Your VCR displays most information both on the VCR and the television.

You can choose to display or hide this information on the television screen (except for the Index, Programming MENU which cannot be hidden).

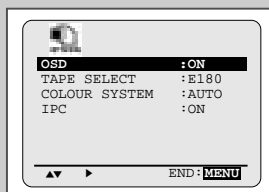
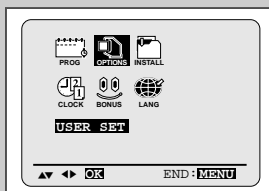

- 1 Press MENU on the remote control.
Result: The programming menu is displayed.
- 2 Press the corresponding ▲, ▼ or ◀, ▶ buttons to select the **USER SET** option.
- 3 Press the OK button to select this option.
Result: The **USER SET** menu is displayed.
- 4 Press the corresponding ▲ or ▼ buttons, until the OSD option is selected.
- 5 **To...** **Press ◀ or ▶, until...**

Display on-screen information	ON is displayed.
Hide on-screen information	OFF is displayed.
- 6 On completion, press MENU twice to exit the menu.

Choosing Your Language

You can change the language in which information is displayed on the screen.

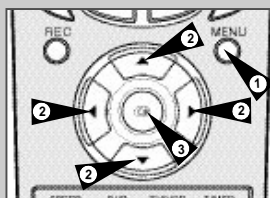

- 1 Press MENU on the remote control.
Result: The programming menu is displayed.
- 2 Press the corresponding ▲, ▼ or ◀, ▶ buttons to select the **LANGUAGE SET** option.
- 3 Press the OK button to select this option.
Result: The **LANGUAGE SET** menu is displayed.
- 4 Select the required language by pressing the ▲ or ▼ buttons.
- 5 Press OK to store the language selected.
- 6 Press MENU to exit the menu.
Result: From now on, all the on-screen information will be displayed in the language selected.

Setting the VCR Output Channel

Your VCR output channel may need to be changed if the pictures suffer from interference or if your TV cannot find the pictures. Also, you can change the VCR output channel to adjust the frequency in which information is displayed on the screen.

- 1 Press MENU on the remote control.
Result: The programming menu is displayed.
- 2 Press the corresponding ▲, ▼ or ◀, ▶ buttons to select the **INSTALLATION** option.
- 3 Press the OK button to select this option.
Result: The **INSTALLATION** menu is displayed.
- 4 Press the corresponding ▲ or ▼ buttons, until the **VCR OUTPUT CH** option is selected.
- 5 Select the required output channel by pressing the ◀ or ▶ buttons.
- 6 On completion, press MENU twice to exit the menu. Then tune your television again (see page 14).

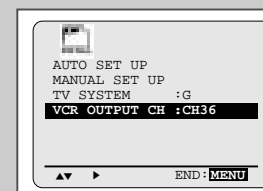

Selecting the RF OUT Sound Mode

You must choose the sound mode (G or K) according to the TV set connected to your VCR.

- 1 Press MENU on the remote control.
Result: The programming menu is displayed.
- 2 Press the corresponding ▲, ▼ or ◀, ▶ buttons to select the **INSTALLATION** option.
- 3 Press the OK button to select this option.
Result: The **INSTALLATION** menu is displayed.
- 4 Press the corresponding ▲ or ▼ buttons, until the **TV SYSTEM** option is selected.
- 5 Press the ▶ button to select G or K.
- 6 On completion, press MENU twice to exit the menu.

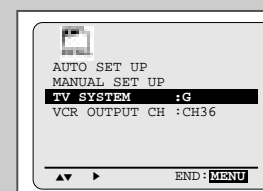

Presetting the Stations Automatically

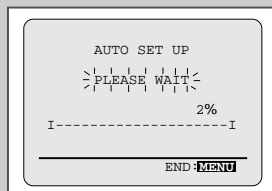
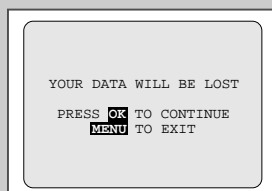
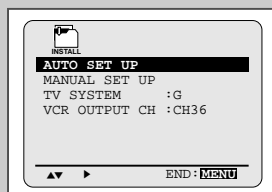
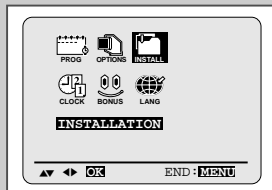

You do not need to preset the stations if you have already set them automatically (see Plug & Auto Set Up on page 13).

Your VCR contains a built-in tuner used to receive television broadcasts.

You must preset the stations received through the tuner. This can be done:

- ◆ Plug & Auto Set up (see page 13)
- ◆ Automatically
- ◆ Manually (see page 19)

You can store up to 50 stations.

- 1 Press the MENU button on the remote control.
Result: The programming menu is displayed.
 - 2 Press the corresponding ▲, ▼ or ◀, ▶ buttons to select the **INSTALLATION** option.
 - 3 Press the OK button to select this option.
Result: The **INSTALLATION** menu is displayed.
 - 4 Press the corresponding ▲ or ▼ buttons, until the **AUTO SET UP** option is selected.
Press the ▶ button to select this option.
 - 5 Press OK to start the auto scanning.
Result:
 - ◆ The **PLEASE WAIT** indication flashes on the television screen.
 - ◆ The first frequency band is scanned and the first station found is displayed and stored.
 - ◆ The VCR then searches for the second station and so on.
 - ◆ When the automatic scanning procedure has finished, the VCR switches automatically to programme 1.
- The number of stations automatically stored by the VCR depends on the number of stations that it has found.
- 6 If you wish to cancel the auto scanning before the end, press the MENU button three times to exit the menu.

➤ ◆ Once the auto scanning procedure has finished, some stations may have been stored more than once; select the stations with the best reception and delete the ones no longer required (see page 20).

Presetting the Stations Manually

Your VCR contains a built-in tuner used to receive television broadcasts.

You must preset the stations received through the tuner. This can be done:

- ◆ Plug & Auto Set up (see page 13)
- ◆ Automatically (see page 18)
- ◆ Manually

You can store up to 50 stations.

You do not need to preset the stations manually if you have already set them automatically.

- 1 Press the MENU button on the remote control.
Result: The programming menu is displayed.
 - 2 Press the corresponding ▲, ▼ or ◀, ▶ buttons to select the **INSTALLATION** option.
 - 3 Press the OK button to select this option.
Result: The **INSTALLATION** menu is displayed.
 - 4 Press the corresponding ▲ or ▼ buttons, until the **MANUAL SET UP** option is selected.
 - 5 Press the ▶ button to select **MANUAL SET UP** option.
Result: The **TV STATION TABLE** menu is displayed.
 - 6 Press the ▲ or ▼ buttons to select a programme number as required.
 - 7 Press the ▶ button to preset the station.
Result: The **MANUAL TUNING** menu is displayed.
 - 8 Press the ◀ or ▶ buttons to start scanning.
Result: The frequency band is scanned and the first station found is displayed.
If you know the number of the channel you want, press the numeric buttons on the remote control for example, for channel 04, first press "0" and then press "0", "4" (see page 43).
- | 9 If you... | Then... |
|---|--|
| Wish to store the station displayed | <ul style="list-style-type: none"> ◆ Press the corresponding ▲ or ▼ buttons, until the MFT is selected. ◆ Press the ◀ or ▶ buttons to adjust the picture, if necessary. ◆ Press OK to store the station . |
| Do <u>not</u> wish to store the station displayed | <ul style="list-style-type: none"> ◆ Press the corresponding ▲ or ▼ buttons, until the CH is selected. ◆ Press the ◀ or ▶ buttons to go on scanning the frequency band and display the next station ◆ Go back to the beginning of Step 9 |
- 10 Repeat this procedure from Step 6 onwards, until all the required stations have been stored.
 - 11 On completion, press the MENU button three times to exit the menu.

GB

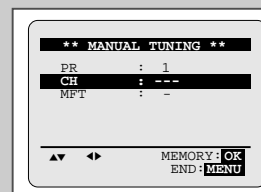
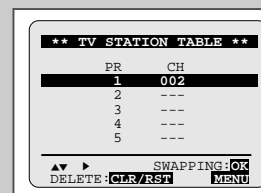
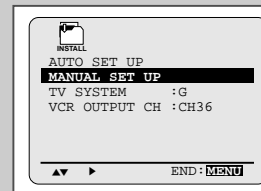

Clearing a Preset Station

If you have stored a TV station:

- ◆ That you do not require
- ◆ At the wrong programme position

you can cancel it.

- 1 Press the MENU button on the remote control.
Result: The programming menu is displayed.
- 2 Press the corresponding ▲, ▼ or ◀, ▶ buttons to select the **INSTALLATION** option.
- 3 Press the OK button to select this option.
Result: The **INSTALLATION** menu is displayed.
- 4 Press the corresponding ▲ or ▼ buttons, until the **MANUAL SET UP** option is selected.
- 5 Press the ▶ button to select this option.
Result: The **TV STATION TABLE** menu is displayed.
- 6 Press the corresponding ▲ or ▼ buttons, until the required preset TV station (PR) is selected.
- 7 Press the CLR/RST button.
- 8 Repeat the same procedure from Step 6 onwards until all the required stations have been cleared.
- 9 On completion, press the MENU button three times to exit the menu.

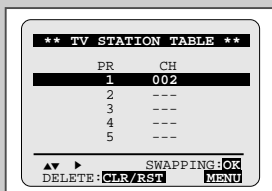
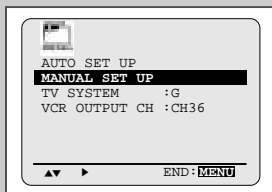

Changing the Preset Station Table

You can rearrange the preset TV stations according to your own preferences programme number assigned to the station.

- 1 Press the MENU button on the remote control.
Result: The programming menu is displayed.
- 2 Press the corresponding ▲, ▼ or ◀, ▶ buttons to select the **INSTALLATION** option.
- 3 Press the OK button to select this option.
Result: The **INSTALLATION** menu is displayed.
- 4 Press the corresponding ▲ or ▼ buttons, until the **MANUAL SET UP** option is selected.
And then press the ▶ button to select this option.
Result: The **TV STATION TABLE** menu is displayed.
- 5 Press the corresponding ▲ or ▼ buttons, until the required preset TV programme is selected.
Result: The selected station is displayed at the same time on the television screen.
- 6 To change the programme number assigned to a station press the OK button on the remote control. (For example, To move a TV station in programme 1 to programme 3)
- 7 Press the ▲ or ▼ buttons to select required position. And then press OK again to swap the position.
- 8 You can modify this station by repeating the same procedure from Step 5 onwards.
- 9 On completion, press the MENU button three times to exit the menu.

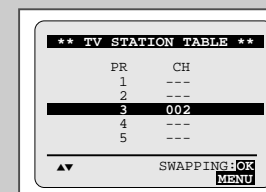
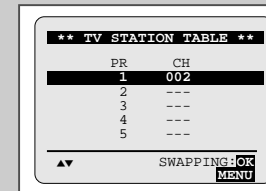
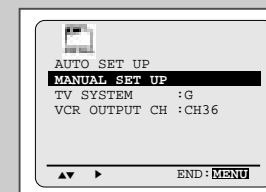
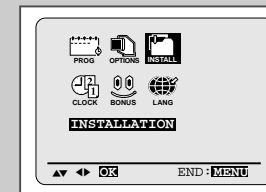

Selecting the Cassette Type

If you wish to use the tape counter to display the time remaining on a cassette, you must indicate the type of cassette inserted.

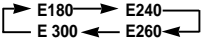
- 1 Press MENU on the remote control.
Result: The programming menu is displayed.
- 2 Press the corresponding ▲, ▼ or ◀, ▶ buttons to select the **USER SET** option.
- 3 Press the OK button to select this option.
- 4 Press the corresponding ▲ or ▼ buttons, until the **TAPE SELECT** option is selected.
- 5 Press the ◀ or ▶ buttons as many times as required, until the correct cassette length is displayed.

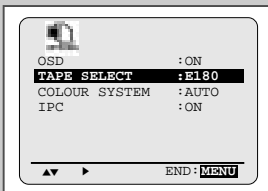
- 6 Press MENU twice to exit the menu.



Selecting the Recording Speed

You can record a cassette at two different speeds:

- ◆ **SP (Standard Play)**
 - ◆ **LP (Long Play)**
- In Long Play modes:**
- ◆ **Each cassette lasts twice as long**

To record a cassette... Press the **SPEED** button on the remote control, until...

- In standard play mode **SP** is displayed.
 In long play mode **LP** is displayed.

Type	Recording Time (in SP)
E-180	180 mins. or 3 hours
E-240	240 mins. or 4 hours
E-260	260 mins. or 4 hours and 20 mins.
E-300	300 mins. or 5 hours

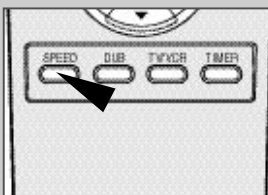

Protecting a Recorded Cassette

Video cassettes have a safety tab to prevent accidental erasure. When this tab has been removed, you cannot record on the tape.

- 1 If you wish to protect a cassette, break off the tab using a small screwdriver.
- 2 To re-record over a protected cassette (safety tab broken), cover the hole with adhesive tape.

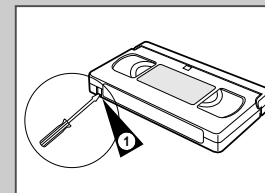

Recording a Programme Immediately

Before recording a programme, you must have preset the corresponding station (unless you are recording via an external video source). If you have not done so, refer to pages 18 and 19.

- 1 Switch on the television.
- 2 To monitor the programme being recorded, select the television channel reserved for use with your VCR (or the AV input if used).
- 3 Insert the cassette on which the programme is to be recorded, with the window visible and the safety tab intact or the opening covered with adhesive tape.
Result: The VCR is switched on automatically.
- 4 Select:
 - ◆ The station to be recorded using the PROG/TRK (▲ or ▼) / PROG (▲ or ▼) buttons
 - or
 - ◆ The LINE IN 1 or LINE IN 2 source using the INPUT button for a satellite tuner or external video source**Result:** The station number is displayed and the programme can be seen on the television.
- 5 Select the recording speed (SP/LP) by pressing the SPEED button as many times as required (see page 22).
- 6 Hold REC down for a while to start recording.
Result: The record indicator appears on the television and VCR display. An index is recorded on the tape (see page 33).
- 7 To stop recording, press ■ once.

-
- ◆ If the cassette is ejected when you start recording, check that the safety tab is intact or the opening is covered with adhesive tape.
 - ◆ If you reach the end of the tape while recording, the cassette rewinds automatically.

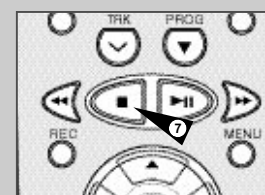
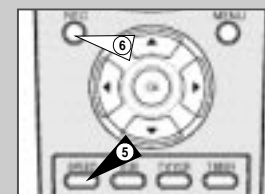
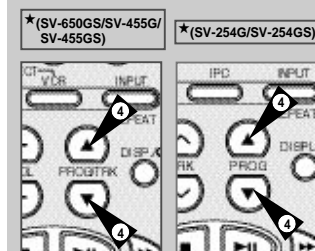

Recording a Programme with Automatic Stop

This function enables you to record up to nine hours of programmes. (LP)
Your VCR stops automatically after the requested length of time.

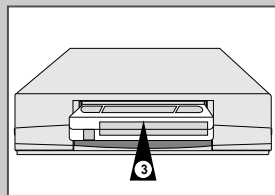

★(SV-650GS/SV-455G/SV-455GS) ★(SV-254G/SV-254GS)

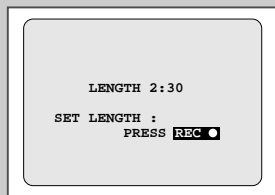
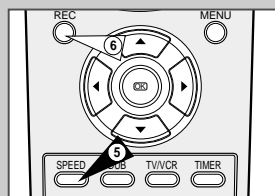
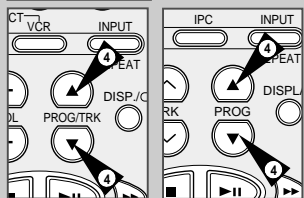

- 1 Switch on the television.
- 2 To monitor the programme being recorded, select the television channel reserved for use with your VCR (or the AV input if used)
- 3 Insert the cassette on which the programme is to be recorded, with the window visible and the safety tab intact or the opening covered with adhesive tape.
Result: The VCR is switched on automatically.
- 4 Select:
 - ◆ The station to be recorded using the PROG/TRK (▲ or ▼) / PROG (▲ or ▼) buttons
 - OR
 - ◆ The LINE IN 1 or LINE IN 2 source using the INPUT button for a satellite tuner or external video source**Result:** The channel number is displayed and the programme can be seen on the television.
- 5 Select the recording speed (SP/LP) by pressing the SPEED button as many times as required (see page 22).
- 6 Hold the REC button down for a while to start recording.
Result: The record indicator appears on the television screen and VCR display. An index is recorded on the tape (see page 33).
- 7 Press the REC button several times to increase the recording time in:
 - ◆ 30-minute intervals up to four hours
 - ◆ 1-hour intervals up to nine hours (LP)**Result:** The length is displayed on the television displays. The selected programme is recorded for the length of time requested. At the end of that time, the VCR stops recording automatically.
- 8 If you wish to cancel the recording before the end, press VCR STANDBY/ON (STANDBY/ON).

- ☞ If the end of the tape is reached while recording:
- ◆ The recording stops
 - ◆ The VCR automatically turns off

Using the Timer Programming Feature

The Timer Programming feature allows you to preset the VCR to record a programme up to one month before that programme is to be broadcast. Up to six programmes can be preset.

- ☞ Before presetting a recording, check that the date and time are correct.

- 1 - Insert the cassette. Press the TIMER button or,
 - ◆ Press MENU on the remote control.
Result: The programming menu is displayed.
 - ◆ Press the OK button to select **TIMER PROGRAMMING** option.
Result: The **TIMER PROGRAMMING** menu is displayed.
- 2 Press ► to select the input source.
- 3 Select the required station by pressing the ▲, ▼ buttons or INPUT to select the LINE IN 1 or LINE IN 2 input sources.
- 4 Press ► to select the recording day.
- 5 Select the required day by pressing the ▲ or ▼ buttons.
- 6 Press ► to select the recording start time.
- 7 Select the required hour value by pressing the ▲ or ▼ buttons.
- 8 Press ► to select the minutes.
- 9 Select the required minute value by pressing the ▲ or ▼ buttons.
- 10 Press ► to select the recording end time.
- 11 Select the required recording end time by pressing the ▲ or ▼ buttons, following the same procedure as when selecting the recording start time.
- 12 Press ► to select the the recording speed (AUTO/SP/LP).
- 13 Press the ▲ or ▼ buttons to switch between the **AUTO**, **SP** (Standard Play) or **LP** (Long Play).
- 14 When you have finished, press the MENU button.
- 15 Press the VCR STANDBY/ON (STANDBY/ON) button to activate the timer.
Result: Before starting recording, the VCR compares the timer duration with the remaining time on the cassette.

- ☞ Auto Tape Speed Select

The VCR's "Auto Tape Speed Select" function compares the duration of the timer recording to the actual recording time remaining on the tape loaded. If there is insufficient tape to complete a timer recording in AUTO mode, the VCR automatically switches to LP mode to record the whole programme.

E.g. If there is a one hour AUTO mode timer recording to be started, but only 40 minutes of tape remaining, the VCR will record in SP for 20 minutes and switch to LP mode for the remaining 40 minutes.

GB

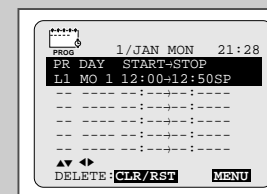
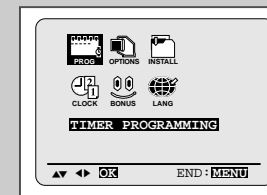
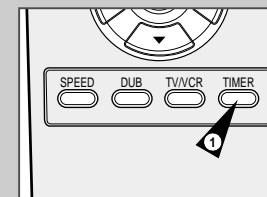

★(SV-650GS/SV-455G/SV-455GS) ★(SV-254G/SV-254GS)

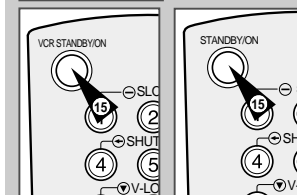

Checking a Preset Recording

You can check your preset recordings:

- ◆ When you have finished presetting the VCR
- ◆ If you have forgotten which programmes will be recorded

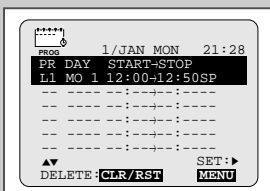

- 1 - Insert the cassette. Press the TIMER button or,
 - ◆ Press MENU on the remote control.
 - Result:** The programming menu is displayed.
 - ◆ Press the OK button to select **TIMER PROGRAMMING** option.
 - Result:** The **TIMER PROGRAMMING** menu is displayed.
- 2 Press the ▲ or ▼ buttons to select the required programme.
- 3 Press the ◀ or ▶ buttons to select and change any values as required. For more details, refer to the previous page.
- 4 On completion, press MENU twice.

Cancelling a Preset Recording

You can cancel any programmes that are:

- ◆ Incorrect
- ◆ No longer required

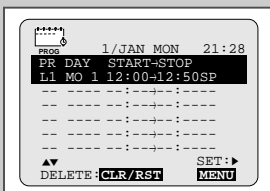

- 1 - Insert the cassette. Press the TIMER button or,
 - ◆ Press MENU on the remote control.
 - Result:** The programming menu is displayed.
 - ◆ Press the OK button to select **TIMER PROGRAMMING** option.
 - Result:** The **TIMER PROGRAMMING** menu is displayed.
- 2 Select the programme to be cancelled by pressing the ▲ or ▼ buttons.
- 3 Press the CLR/RST button to cancel the selected programme.
 - Result:** All the recording information is deleted and the broadcast will not be recorded.
- 4 On completion, press MENU twice.

★(SV-650GS/SV-455G/SV-455GS)



★(SV-254G/SV-254GS)



Playing a Cassette

This function allows you to play back any pre-recorded cassette.

- 1 Switch on both the television and your VCR.
- 2 Insert the video cassette to be played. If the safety tab on the cassette is intact, press ►II.
 - Otherwise, the cassette is played automatically.
 - When a cassette is loaded, the tape position is optimized automatically to reduce disturbance (Digital Auto Tracking). When playing a cassette, if the end of the tape is reached, the cassette is rewound automatically. NTSC tapes can be played back but cannot be recorded with this VCR.
- 3

To...	Then press...
Stop the playback	■ (STOP).
Eject the cassette	▲ (EJECT).

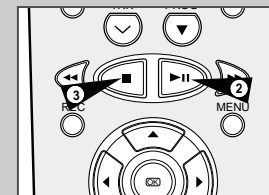

Adjusting Picture Alignment Automatically ★(SV-254G/SV-254GS Only)

The Picture Alignment feature enables you to optimize the tape position automatically to obtain the best possible picture.

When noise bars or streaks appear during playback, adjust picture alignment by pressing the A.TRK button.

- Result:**
- ◆ The tracking bar appears.
 - ◆ The picture is automatically adjusted.
 - ◆ The tracking bar disappears when digital auto tracking has been completed.

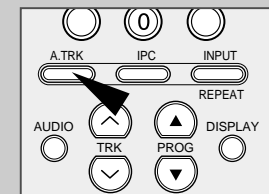

Adjusting Picture Alignment Manually

The Picture Alignment feature allows you to adjust the alignment manually to obtain the best possible picture.

When noise bars or streaks appear during playback, adjust alignment manually by pressing the PROG/TRK (▲ or ▼) / TRK (∧ or ∨) buttons until the picture is clear and stable.

- Result:**
- ◆ The tracking bar appears.
 - ◆ The image is adjusted.
 - ◆ The tracking bar disappears when you release the button.

★(SV-650GS/SV-455G/SV-455GS)

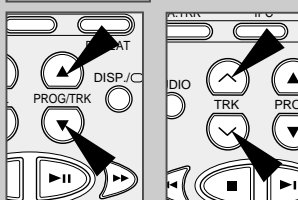

Intelligent Picture Control

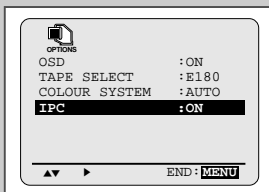

The Intelligent Picture Control Feature allows you to adjust the sharpness of the image automatically, according to your own preferences.

- 1 During playback, press the MENU button on the remote control.
Result: The programming menu is displayed.
- 2 Press the corresponding ▲, ▼ or ◀, ▶ buttons to select the **USER SET** option.
- 3 Press the OK button to select this option.
Result: The **USER SET** menu is displayed.
- 4 Press the corresponding ▲ or ▼ buttons, until the **IPC** option is selected.
- 5 Press the ▶ button to select the IPC (intelligent picture control) option.
➤ When intelligent picture control mode is **ON**, the sharpness of the image is adjusted automatically.
- 6 To adjust the sharpness manually, press the ▼ button to turn the IPC mode **OFF**.
- 7 Press the ◀ or ▶ buttons until the picture is displayed according to your preferences.
To adjust the sharpness manually press the SHARPNESS ◀ or ▶ button on the front of VCR. (* **SV-650GS only**)
➤ If you do not press a button within ten seconds, the **PICTURE** menu disappears automatically.
- 8 On completion, press the MENU button again.

Intelligent Picture Control ★(SV-254G/SV-254GS Only)

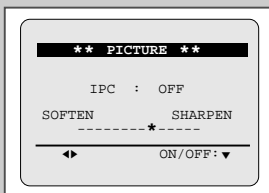
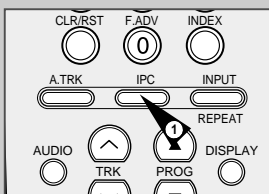

The Intelligent Picture Control Feature allows you to adjust the sharpness of the image automatically, according to your own preferences.

- 1 During playback, press the IPC button on the remote control.
- 2 Press the ▼ button to turn the IPC (intelligent picture control) option **ON** and **OFF**.
➤ When intelligent picture control mode is **ON**, the sharpness of the image is adjusted automatically.
- 3 To adjust the sharpness manually, select intelligent picture control mode **OFF**.
◆ The horizontal picture adjusting appears.
- 4 Press the ◀ or ▶ buttons until the picture is displayed according to your preferences.
➤ If you do not press a button within ten seconds, the **PICTURE** menu disappears automatically.
- 5 On completion, press the IPC button again.

Selecting the Colour Mode

Before recording or playing back a cassette, you can select the required system standard.

- ◆ When you playback an NTSC-recorded tape on this VCR make a setting on the colour system according to your TV. If your TV is a PAL system only TV, set NTPB. If your TV is Multi System TV (NTSC 4.43 compatible), set NT4.43 and you can record NT4.43.

- 1 Press MENU on the remote control.
Result: The programming menu is displayed.
 - 2 Press the corresponding ▲, ▼ or ◀, ▶ buttons to select the **USER SET** option.
 - 3 Press the OK button to select this option.
Result: The **USER SET** menu is displayed.
 - 4 Press the corresponding ▲ or ▼ buttons, until the **COLOUR SYSTEM** option is selected.
 - 5 Press the ▶ button to select **AUTO** → **PAL** → **MESECAM** → **B/W** or **NT3.58** → **NT4.43** → **NTPB**.
- | | |
|-------------|---|
| AUTO | When playing back a cassette, the system standard is automatically selected by the VCR. |
| B/W | Black and White |
- 6 On completion, press MENU twice to exit the menu.

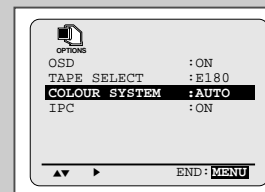

Selecting the Audio Output Mode

★(SV-650GS Only)

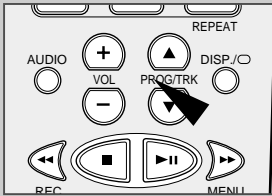

When monitoring a TV programme or playing back a Hi-Fi recorded video tape, press the AUDIO button to select a desired sound output. As the AUDIO button is pressed, the sound output and the indicator change as below:

Sound type	Stereo sound	Bilingual sound	Standard sound broadcast
OSD display	Heard in stereo. (left channel and right channel)	Channel I (MAIN) heard from the left speaker, channel II (SUB) heard from the right speaker.	Heard in monaural.
	Left channel heard from both the left and right speakers.	Channel I (MAIN) heard from both the left and the right speakers.	Heard in monaural.
	Right channel heard from both the left and right speakers.	Channel II-(SUB) heard from both the left and the right speakers.	Heard in monaural.
	Sound mixed the left and right channels, and the normal audio track.		
	Heard in monaural.	Channel I (MAIN) heard from both the left and the right speakers.	Heard in monaural.

Selecting the Audio Mute Mode

★(SV-455G/SV-455GS/SV-254G/SV-254GS Only)

★(SV-455G/SV-455GS) ★(SV-254G/SV-254GS)

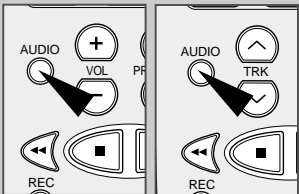

You can select the mode in which the sound is mute.

To select the audio mute mode on and off, simply press the AUDIO button on the remote control.



Playing a Cassette in Slow Motion

★(SV-650GS/SV-455G/SV-455GS Only)

You can play a cassette in slow motion.

➤ No sound is heard when playing back a cassette in slow motion.

- Press:
 - ◆ to start playing the cassette
 - ◆ SLOW () as many times as required to decrease or increase the speed respectively

☞ To return to the normal speed, press the button twice.
 - When playing back in slow motion, picture interference may occur. Press the PROG/TRK (or) buttons to minimize this effect.
- ☞ When you have been using the Slow Motion function for more than about five minutes, the VCR will automatically play to protect the:
- ◆ Cassette
 - ◆ Video heads

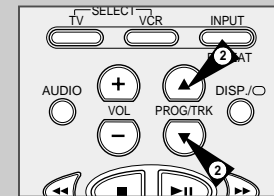
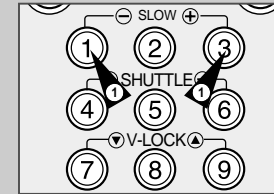

Playing a Sequence Frame by Frame

You can:

- ◆ Stop the cassette at a given frame (image)
- ◆ Advance one frame at a time

➤ No sound is heard when playing back frame by frame.

- Press:
 - ◆ to start playing the cassette
 - ◆ to stop the tape at a given frame
 - ◆ F.ADV () to advance frame by frame
- To return to normal playback, press .

☞ When you have been using the Frame-by-Frame function for more than about five minutes, the VCR will automatically play to protect the cassette and video heads.

➤ Vertical stability: When playing back frame by frame, interference may be seen on the screen. Press the V-LOCK () buttons to minimize this effect.

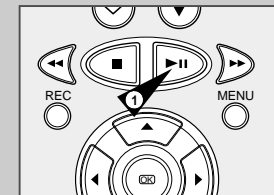

Picture Search, Fast Forward/Rewind

Picture Search enables you to Fast Forward or Rewind and look for a particular part of a tape.

- 1 Press PLAY, the VCR will enter normal play mode. While in play, press and release the ►► (or ◀◀) button. The VCR will search at 5 times the normal playback speed.
- 2 To return to normal playback mode, press the ►|| button.
- 3 If you press and HOLD down the ►► (or ◀◀) button the VCR will search at 9 times the normal speed. Releasing the ►► button will return the VCR to search at 5 times the normal speed. To return to normal playback mode, press the ►|| button.
- 4 Whilst in Picture Search mode, if you press the ►► button again, the VCR will enter normal Fast Forward mode.
- 5 Likewise, whilst in Picture Search ◀◀ mode, if you press the ◀◀ button again, the VCR will enter normal Rewind mode.
- 6 If, when Redwing (◀◀) or Fast Forwarding (►►), you press the ◀◀ (or ►►) button, the VCR will enter the Picture Search mode.

Playing a Sequence at Variable Speeds



★(SV-455G/SV-455GS)-Front Panel

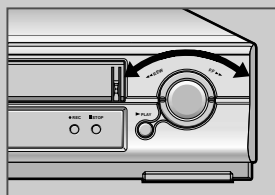

You can vary the playback speed using the Shuttle function (up to nine times the normal speed).

Example: You wish to analyze a sportsperson's technique, movement by movement.

The Shuttle function is available on the:

- ◆ Remote control
- ◆ Front panel of the VCR ★(SV-455G/SV-455GS only)

➤ No sound is heard when playing a sequence at variable speeds.

- 1 Press:
 - ◆ ►|| during playback
 - ◆ SHUTTLE (⊖) to play the cassette backwards
 - ◆ SHUTTLE (⊕) to play the cassette forwards
 You can also turn the SHUTTLE ring on the front panel of the VCR. ★(SV-455G/SV-455GS only)
- 2 Each time you press a SHUTTLE (⊖/⊕) button, the speed is changed as shown in the following illustration.

REVERSE PLAY X9	REVERSE PLAY X5	REVERSE PLAY X3	STILL	SLOW MOTION X1/10	SLOW MOTION X1/5	PLAY	PLAY X3	PLAY X5	PLAY X9
-----------------------	-----------------------	-----------------------	-------	-------------------------	------------------------	------	------------	------------	------------

Searching for a Specific Sequence

Each time you record a cassette on this VCR, an "index" is automatically marked on the tape when recording starts.

The Search function allows you to fast-forward or rewind to a specific index and start playback from that point. Depending on the direction selected, the indexes are numbered as follows:

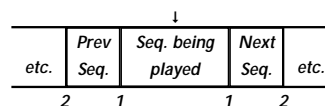

➤ This VCR uses a standard indexing system (VISS). As a result, it will recognize any indexes marked by other VCRs using the same system and vice versa.

INTRO SCAN

- 1 To search for a specific index, press INDEX.
- 2 Press the ◀◀ or ►► buttons depending on the direction where your desired programme is located.
- 3 When an Index mark is found the VCR will playback the tape for 5 seconds, after which it will continue searching for the next Index mark.
- 4 If you want to watch the tape from a particular Index, simply press ►||.

Index Skip Search:

This feature will enable you to fast forward/rewind to a specific point on a tape: E.g. if you have recorded 3 different programmes on a tape and you have rewound the tape to the beginning, by using this feature you can go directly to the start of programme 2 simply by pressing the INDEX button.

- 1 Press the INDEX to start the Index search.
- 2 Press the ◀◀ or ►► buttons twice more. This will take you directly to the start of the desired programme is located.
- 3 These Index searches can be made forwards: (press ►►) or backwards: (press ◀◀).
- 4 To cancel an Index search simply press the ►|| or ■ button.

GB

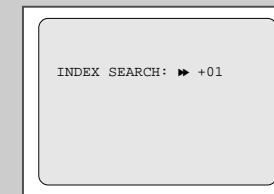
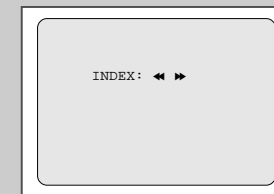
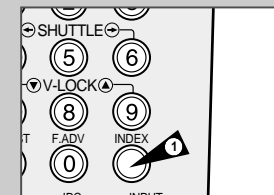

Auto Repeat Play

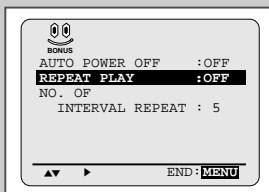

You can set repeat play to repeat the tape continuously from beginning to end.

- 1 Press MENU on the remote control.
Result: The programming menu is displayed.
- 2 Press the corresponding ▲, ▼ or ◀, ▶ buttons to select the **EASY OPERATION** option.
- 3 Press the OK button to select this option.
Result: The **EASY OPERATION** menu is displayed.
- 4 Press the corresponding ▲ or ▼ buttons, until the **REPEAT PLAY** option is selected.
- 5 To... Press ◀ or ▶, until...

Repeat play	ON is displayed.
Do not wish to repeat play	OFF is displayed.
- 6 On completion, press MENU twice to exit the menu.

Interval Repeat Play

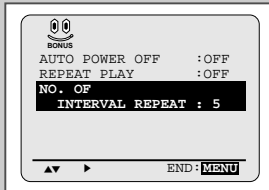

You can set interval repeat play to repeat the cassette several times for special interval.

- 1 Press MENU on the remote control.
Result: The programming menu is displayed.
- 2 Press the corresponding ▲, ▼ or ◀, ▶ buttons to select the **EASY OPERATION** option.
- 3 Press the OK button to select this option.
Result: The **EASY OPERATION** menu is displayed.
- 4 Press the corresponding ▲ or ▼ buttons, until the **NO. OF INTERVAL REPEAT** option is selected.
- 5 To... Press ▶, until...

Interval repeat play	5, 10, 15 is displayed. (choose repeat time 5 times, 10 times, 15 times)
Cancel interval repeat play	OFF is displayed.
- 6 On completion, press MENU twice to exit the menu.
- 7 To select interval during playback, press the INPUT/REPEAT button at the desired start point.
Result: "INTERVAL REPEAT SETTING" is displayed.
Press the INPUT/REPEAT button one more time at the desired end point.
Result: The tape is automatically rewound to the start point.
"INTERVAL REPEAT" is displayed.

Using the Tape Counter

The tape counter:

- ◆ Indicates the elapsed time in the play and record modes (hours, minutes and seconds)
- ◆ Is reset when a cassette is inserted in the VCR
- ◆ Allows you to find the beginning of a sequence easily



If the remaining time is to be calculated correctly, you must indicate the type of cassette being used.

- 1 Insert a cassette in your VCR.
- 2 To set the tape counter to zero at the beginning of a sequence:
 - ◆ Press DISP/○ or DISPLAY twice to display the counter
 - ◆ Press CLR/RST when you want to set the tape counter to zero
- 3 When you are ready,
 - ◆ Start playback or Recording.
 - ◆ Press the ■ button.
 - ◆ To fast-forward or rewind to the sequence at which the counter was set to zero, press ◀◀ or ▶▶.



Some VCR information, such as the counter, can be displayed on the television screen (unless you have deactivated the OSD mode; refer to page 16).

Press DISP/○ or DISPLAY:

- ◆ Once to display the current function, programme number, recording speed, date, time and counter
- ◆ Twice to display the counter only
- ◆ Three times to display the time remaining on the cassette
- ◆ Four times to clear the display

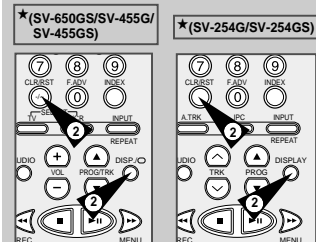
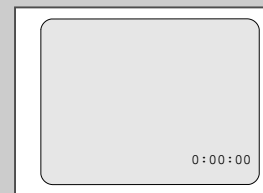

Connecting an RCA Audio/Video Input Cable

★(SV-650GS)

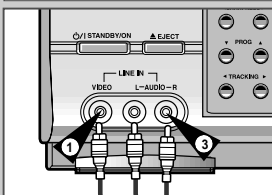

★(SV-455G/SV-455GS)

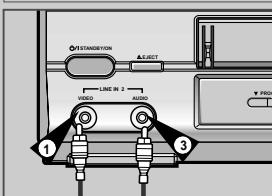

★(SV-254G/SV-254GS)

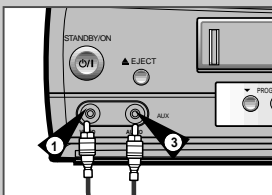

You can connect other audio/video equipment to your VCR using audio/video cables if the appropriate outputs are available on the equipment chosen.

Examples: ♦ You wish to copy a video cassette with the help of a second VCR (see page 37).

♦ You wish to play back and/or copy pictures taken with a camcorder (see page 37).

♦ Regardless of the type of connection chosen, you must always connect the coaxial cable supplied. Otherwise, no picture will be visible on the screen when the VCR is switched off.

♦ Make sure that both the television and the VCR are switched off before connecting the cables.

- 1 Connect one end of the RCA audio/video cable into the VIDEO INPUT socket on the front of the VCR.
- 2 Plug the other end of the audio/video cable into the appropriate output connector on the other system (VCR or camcorder).
- 3 Connect one end of the RCA audio cable supplied into the AUDIO INPUT sockets on the front of the VCR.
 - Take care to respect the colour coding of the left and right channels.
- 4 Plug the other end of the audio cable into the appropriate output connectors on the other system (VCR, camcorder or sound system).

Using the Assemble Edit Function

This function allows you to start a new recording at a specific position on the cassette while maintaining a very smooth scene change.

- 1 Insert the cassette to be edited in your VCR.
- 2 Press the ►II button to start playback.
- 3 When you reach the position from which you wish to start the new recording, press the ►II button.
- 4 Press the F.ADV (FADV) button again as often as necessary to advance frame by frame, until the exact recording position is located.
- 5 While the VCR is in still mode, hold the REC button down for a while to activate the Assemble Edit function.

Result: Record symbol flashes in the display.
- 6 Select the source from which you wish to record by pressing:
 - ♦ The PROG/TRK (▲ or ▼) / PROG (▲ or ▼) buttons for television channels
 - ♦ The INPUT button for the LINE IN 1 or LINE IN 2 input sources
- 7 Press the ►II button to start recording.
- 8 When you have finished recording, press ■.

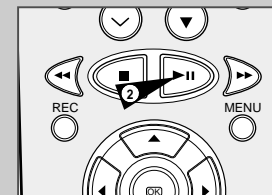

Recording from Another VCR or Camcorder

You can copy a cassette to your VCR from another video source, such as another VCR or a camcorder.

It is an infringement of copyright laws to copy prerecorded cassettes or to re-record them in any form without the permission of the owners of the corresponding copyright.

- 1 Connect the VCR, from which the cassette is to be copied, to the appropriate RCA audio and video input connectors on the rear of your VCR, as indicated on page 12. You can also use an RCA audio and video cable to connect the LINE IN 2 input on the front of your VCR.
- 2 Insert a blank cassette in your VCR.
- 3 Insert the pre-recorded cassette in the other video source (VCR or camcorder).
- 4 Press the INPUT button to select the appropriate input on your VCR:
 - ♦ LINE IN 1 for the rear input
 - ♦ LINE IN 2 for the front input
- 5 Start playing back the cassette to be copied.
- 6 Hold REC down for a while to start recording on your VCR.
- 7 When you have finished recording, press ■ on both VCRs.

➤ If you wish to view the cassette being copied:

- ♦ Your VCR must be connected as usual to the television (see page 10 for further details)

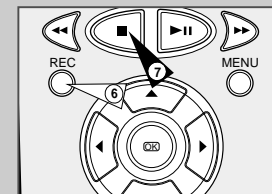
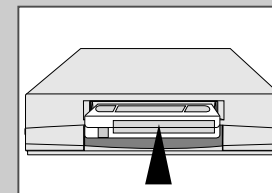

Audio Dubbing a Pre-recorded Cassette★(SV-650GS Only)

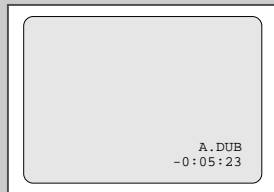
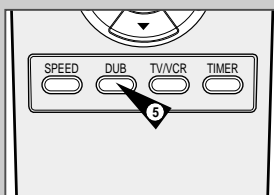
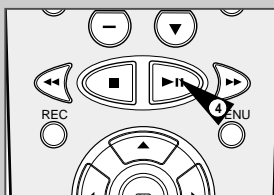
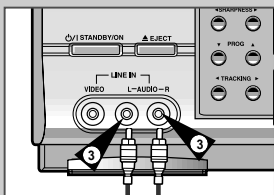
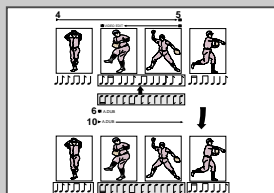

With the Audio Dubbing function, you erase the previously recorded sound and replace it with a new soundtrack from:

- ◆ A CD player
- ◆ A microphone connected to a sound system
- ◆ A cassette player

Restriction:

Audio dubbing is applicable only to the longitudinal audio track (normal audio).

- 1 Connect an RCA audio cable to the appropriate output on your sound system (CD/cassette player for example).
- 2 Connect the other end of the RCA audio cable to the audio input connectors (L, R) on the front of your VCR.
- 3 Insert the pre-recorded cassette on which the audio track is to be replaced, and press the ►► to start playback.
- 4 Find the scene that you want to over-dub and press ►► on the remote control.
- 5 Press DUB.
Result: Your VCR is now in the Audio dubbing Pause mode.
- 6 On the sound system, locate the point on the CD or cassette at which you wish to start playback.
Example: The track that you wish to record on the cassette.
- 7 When you are ready:
 - ◆ Start playback on the sound system
 - ◆ Press REC on the remote control.
 Result: The soundtrack is replaced on the pre-recorded cassette.

- The new sound will be recorded on the normal sound track of the tape, and the original sound will remain on the Hi-Fi sound track.
To hear the new sound and original sound mixed together, press the Audio button on the remote control until the MIX option is displayed (see page 30).

Using the TV Buttons on the Remote Control★(SV-650GS/SV-455G/SV-455GS Only)

Your VCR remote control will work with Samsung televisions and compatible brands.

To determine whether your television is compatible, follow the instructions below.

- 1 Switch your television on.
- 2 Point the remote control towards the television.
- 3 Hold down the TV button and enter the two-figure code corresponding to the brand of your television, by pressing the appropriate numeric buttons.

Brand	Codes	Brand	Codes
SAMSUNG	01 to 06	PHILIPS	02, 20, 22
AKAI	09, 23	SABA	13, 14, 22 to 24
GRUNDIG	09, 17, 21	SONY	15, 16
LOEWE	02	THOMSON	13, 14, 24
PANASONIC	08, 23 to 27	TOSHIBA	07, 16 to 19, 21

Result: If your television is compatible with the remote control, it will switch off. It is now programmed to operate with the remote control.

- If several codes are indicated for your television brand, try each one in turn until you find one that works.

➤ When you change the batteries in the remote control, you must reprogramme the code, following the same procedure.

You can then control the television using the following buttons.

Button	Function
TV STANDBY/ON ①	Used to switch the television on and off.
TV or VCR ②	Used to switch between the TV and VCR modes. Only the VOL (+ or -) and TV STANDBY/ON buttons are operational in VCR mode.
-/- ③	Used to enter a two-figure programme number. Example: For programme 12, press -/- followed by numeric buttons 1 and 2.
INPUT ④	Used to select an external source.
VOL + or - ⑤	Used to adjust the volume of the television.
PROG/TRK (▲ or ▼) ⑥	Used to select the required programme.
DISP./O ⑦	Used to switch between an external source and the television tuner.

➤ The various functions will not necessarily work on all televisions. If you encounter problems, operate the television directly.

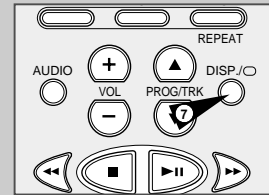
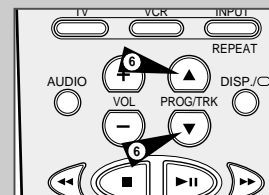
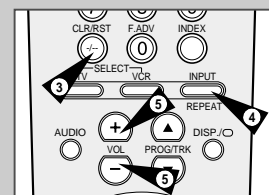
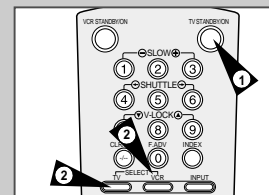

Auto Power Off

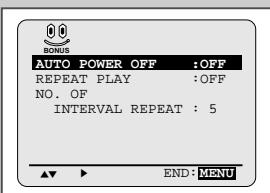

The Auto Power Off feature automatically turns off your VCR if no signal is received and you do not press any button for the selected time.

- 1 Press MENU on the remote control.
Result: The programming menu is displayed.

- 2 Press the corresponding ▲, ▼ or ◀, ▶ buttons to select the **EASY OPERATION** option.

- 3 Press the OK button to select this option.
Result: The **EASY OPERATION** menu is displayed.

- 4 Press the corresponding ▲ or ▼ buttons, until the **AUTO POWER OFF** option is selected.

- 5 Press the ▶ button, until you select the time of Auto Power off interval.

→ OFF → 2HOUR → 3HOUR →

- 6 On completion, press MENU twice to exit the menu.

Technical Specifications

Design and specifications are subject to change without notice.

MODEL	SV-650GS	SV-455G/455GS/254G/254GS
Format	VHS PAL/NTSC standard	VHS PAL/NTSC standard
Heads	Video: 4 rotary heads Hi-Fi Audio: 2 rotary heads Audio/Control: 1 stationary head Erase: 1 full track erase head	Video: 2 rotary heads (SV-254G/254GS) 4 rotary head (SV-450G/455GS) Audio/Control: 1 stationary head Erase: 1 full track erase head
Receiving channel	VHF-I, VHF-III, UHF, Interband/ Hyperband	VHF-I, VHF-III, UHF, Interband/ Hyperband
Television system	STANDARD B/G, D/K	STANDARD B/G, D/K
Luminance	FM azimuth recording	FM azimuth recording
Colour system	PAL/MESECAM/NT4.43: Down converted subcarrier phase shifted direct recording NTSC PB on PAL TV	PAL/MESECAM/NT4.43: Down converted subcarrier phase shifted direct recording NTSC PB on PAL TV
Tape speed	SP 23.39 mm/sec LP 11.69 mm/sec	SP 23.39 mm/sec LP 11.69 mm/sec
Recording/playback time	SP 3 hours (E-180 Tape) LP 6 hours (E-180 Tape)	SP 3 hours (E-180 Tape) LP 6 hours (E-180 Tape)
REW time	About 60 sec in REW with E-180	About 60 sec in REW with E-180
VIDEO		
Input	0.5 to 2.0 Vp-p; 75 ohm unbalanced	0.5 to 2.0 Vp-p; 75 ohm unbalanced
Output	1.0 ± 0.2 Vp-p; 75 ohm unbalanced	1.0 ± 0.2 Vp-p; 75 ohm unbalanced
Signal-to-noise ratio	Better than 43 dB (SP)	Better than 43 dB (SP)
Horizontal resolution	More than 240 lines	More than 240 lines
AUDIO		
Input	-8 dBm, 47 Kohm unbalanced	-8 dBm, 47 Kohm unbalanced
Output	-8 ± 3 dBm, 1 Kohm unbalanced	-8 ± 3 dBm, 1 Kohm unbalanced
Wow and flutter (WTD)	0.4% max (SP)	0.4% max
Signal-to-noise ratio	68 dB min (IHF A filter)	42 dB min (IHF A filter)
Frequency response	20Hz - 30kHz	100Hz - 8kHz
Power requirement	100-240V~, 50/60 Hz	100-240V~, 50/60 Hz
Power consumption	Approx. 17 watts	Approx. 15 watts
Operation temperature	41°F-104°F (5°C-40°C)	41°F-104°F (5°C-40°C)
Operation humidity	10%-75%	10%-75%
Weight	2.8 Kg (net)	2.8 Kg (net)
Dimensions (WxHxD)	430 x 94 x 240 mm	360 x 94 x 240 mm

THIS APPLIANCE IS DISTRIBUTED BY

