

DVD PLAYER

DVD-E138A

DVD-1010

DVD-E138B

DVD-E238

DVD-E338K

DVD-P538K



Precautions

1. Setting up

Ensure that the mains supply in your house complies with that indicated on the identification sticker located at the back of your play. Install your player horizontally, on a suitable base (furniture), with enough space around it for ventilation (7~10cm). Make sure the ventilation slots are not covered. Do not stack other, or heavy devices on top of the player. Do not place the player on amplifiers or other equipment which may become hot. Before moving the player ensure the disc tray is empty. This player is designed for continuous use.

Switching off the DVD player to the stand-by mode does not disconnect the electricity supply. In order to separate the player completely from the mains, it has to be disconnected by unplugging the main plug, especially when left unused for a long period of time.

2. For your safety

Never open the player or any of its components. It can be dangerous for you or certain fragile components. You could receive an electric shock or touch the laser beam. Do not place your eyes close to the opening of the disc tray or any other opening to look inside the player.

3. Caution

Protect the player from moisture (dripping or splashing and objects filled with liquids), and excess heat (e.g. fireplace) or equipment creating strong magnetic or electric fields (i.e. speakers...). Disconnect the power cable from the mains electricity supply if the player malfunctions.

Your player is not intended for industrial use but for domestic purposes only. Use of this product is for personal use only. If your player or disc has been stored in a cold atmosphere for example during transportation in the winter, wait for approximately 2 hours until they have reached room temperature, before use.

4. Disc

Be careful handle your discs with care. Hold a disc with finger on the border or hole. Always place disc with the label facing upward (in case of a single side disc). Always use a soft cloth to clean disc if necessary, wipe from the centre to the border. Always put disc back into their cases after playing and store in vertical position. Always place the disc properly into the tray using the proper guide area. Never use record cleaning sprays, benzine, static electricity liquids or any other solvent, if the disc surface is dirty. Wipe gently with a soft damp (water only) cloth, never wipe the disc in a circular motion, since circular scratches are likely to occur and could cause noise during playback.

5. Environmental info

Batteries: The battery used in this product contains chemicals that are harmful to the environment. Do not dispose of batteries in the general domestic waste. It is recommended that the replacement of the battery should be done by a technician.

Disposal of old equipment and packaging: Old equipment and packaging should not be disposed of as domestic waste, but in accordance with the applicable regulations.

6. Maintenance of Cabinet

For safety reasons, be sure to disconnect the AC power cord from the AC outlet.

- Do not use benzene, thinner, or other solvents for cleaning.
- Wipe the cabinet with a soft cloth.

Precautions

1

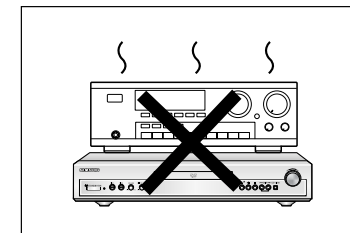
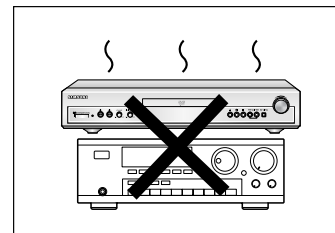
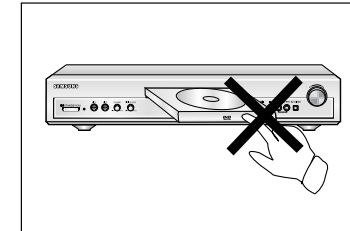
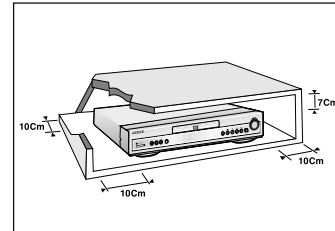

2

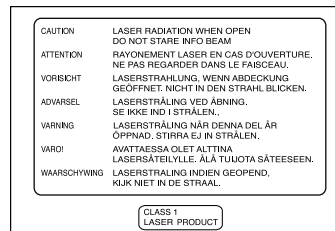

3

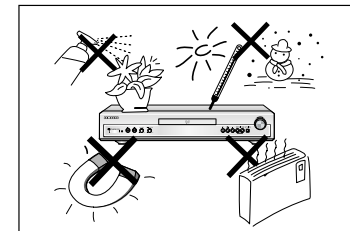

4

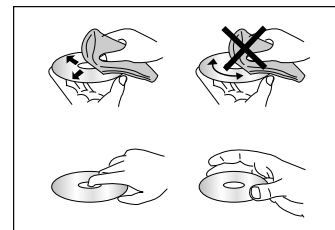

5

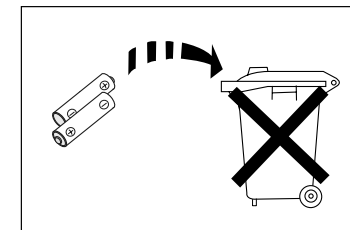

Before you start

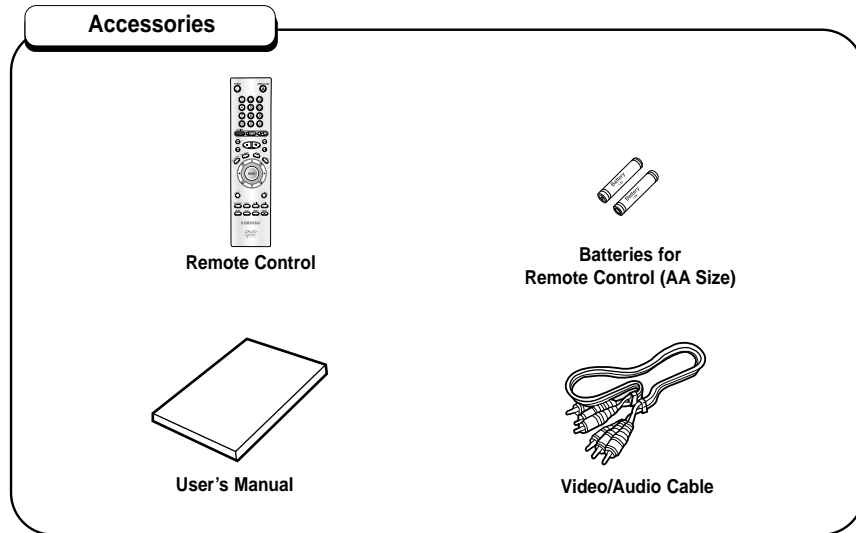

Install Batteries in the Remote

- 1 Open the battery cover on the back of the remote.
- 2 Insert two AA batteries. Make sure that the polarities (+ and -) are aligned correctly.
- 3 Replace the battery cover.

If remote doesn't operate properly:

- Check the polarity + - of the batteries (Dry-Cell)
- Check if the batteries are drained.
- Check if remote sensor is blocked by obstacles.
- Check if there is any fluorescent lighting nearby.

Table of contents

Setup

General Features	6
Disc Type and Characteristics	7
Description-Front Panel	8
Display Indicators	10
Description-Rear Panel	11
Tour of the Remote Control	14

Connections

Choosing a Connection	20
-----------------------------	----

Basic Functions

Playing a Disc	23
Using the Search & Skip Functions	25
Using the Display Function	26
Using the Disc and Title Menu	27
Using the Function Menu	28
Repeat Play	29

Advanced Functions

Adjusting the Aspect Ratio (EZ View)	30
Slow Repeat play	32
Selecting the Audio Language	33
Selecting the Subtitle Language	34
Changing the Camera Angle	35
Using the Instant Replay/Skip Function	36
Using the Bookmark Function	37
Using the Zoom & 3D Sound Functions	38
MP3/WMA Play	39
Program Play & Random Play	41
Picture CD Playback	42

Karaoke Functions

Beginning Karaoke Functions	44
Reserving a Song	45
Vocal Function	46

Changing Setup menu

Using the Setup Menu	47
Setting Up the Language Features	48
Setting Up the Audio Options	50
Surround Sound Speaker Setup	51
Setting Up the Display Options	52
Setting Up the Parental Control	54
Controlling a TV with the remote	55

Reference

Troubleshooting	56
Specifications	57

SETUP

CONNECTIONS

BASIC FUNCTIONS

ADVANCED FUNCTIONS

KARAOKE FUNCTIONS

CHANGING SETUP MENU

REFERENCE

General Features

Excellent Sound

Dolby Digital, a technology developed by Dolby Laboratories provides crystal clear sound reproduction.

Screen

Video with MPEG-2 compression technology. Both regular and widescreen(16:9) pictures can be viewed.

Slow Motion

An important scene can be viewed in slow motion.

Programmed Play

You can program tracks to play in desired order. (CD, WMA, MP3)

Parental Control

The parental control allows users to set the level necessary to prohibit children from viewing harmful movies such as those with violence, adult subject matter, etc.

Various On-Screen Menu Functions

You can select various languages (Audio/Subtitle) and screen angles while enjoying movies.

Easy View

Easy View can convert Letter Box images to full screen viewing on your conventional TV.

Digital Photo Viewer (JPEG)

You can view the Digital Photos on your TV.

Repeat

You can repeat a song or movie simply by pressing the REPEAT button.

MP3/WMA

This unit can play discs created from MP3/WMA files.

Instant Replay

This function is used to replay the previous 10 seconds of the movie from the current position.

Instant Skip

This function skips playback ahead 10 seconds.

Progressive Scan (DVD-P538K Only)

Progressive scanning creates an improved picture with double the scan lines of a conventional interlaced picture.

NOTE

* Discs which cannot be played with this player.

- DVD-ROM
- DVD-RAM
- CD-ROM
- CDV
- CDI
- HD layer of super Audio CD
- CDGs play audio only, not graphics.

* Ability to play back may depend on recording conditions.

- DVD-R, +R
- CD-RW
- DVD+RW, -RW



COPY PROTECTION

• Many DVD discs are encoded with copy protection. Because of this, you should only connect your DVD player directly to your TV, not to a VCR. Connecting to a VCR results in a distorted picture from copy-protected DVD discs.

• This product incorporates copyright protection technology that is protected by methods claims of certain U.S. patents and other intellectual property rights owned by Macrovision Corporation and other rights owners. Use of this copyright protection technology must be authorized by Macrovision Corporation, and is intended for home and other limited viewing uses only unless otherwise authorized by Macrovision Corporation. Reverse engineering or disassembly is prohibited.

Disc Type and Characteristics

This DVD player is capable of playing the following types of discs with the corresponding logos:

Disc Types (Logos)	Recording Types	Disc Size	Max. Playing Time	Characteristics
	Audio + Video	12 Cm	Single-sided 240 min. Double-sided 480 min.	<ul style="list-style-type: none"> • DVD contains excellent sound and video due to Dolby Digital and MPEG-2 system. • Various screen and audio functions can be easily selected through the on-screen menu.
		8 Cm	Single-sided 80 min. Double-sided 160 min.	
	Audio + Video	12 Cm	74 min.	<ul style="list-style-type: none"> • Video with CD sound, VHS quality & MPEG-1 compression technology.
		8 Cm	20 min.	
	Audio	12 Cm	74 min.	<ul style="list-style-type: none"> • CD is recorded as a Digital Signal with better audio quality, less distortion and less deterioration of audio quality over time.
		8 Cm	20 min.	

Disc Markings



• Play Region Number



• NTSC broadcast system in U.S.A, Canada, Korea, Japan, etc.



• Dolby Digital disc



• Stereo disc



• Digital Audio disc



• DTS disc



• MP3 disc

Play Region Number

Both the DVD player and the discs are coded by region. These regional codes must match in order for the disc to play. If the codes do not match, the disc will not play.

The Region Number for this player is described on the rear panel of the player.

Description-Front Panel

DVD-E138A/DVD-1010

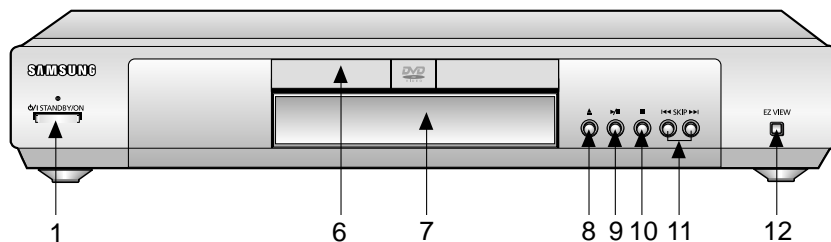

DVD-E138B

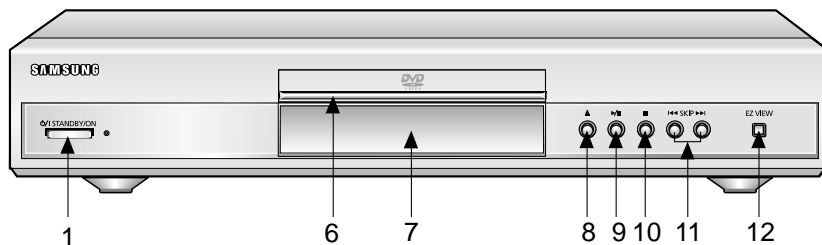

DVD-E238

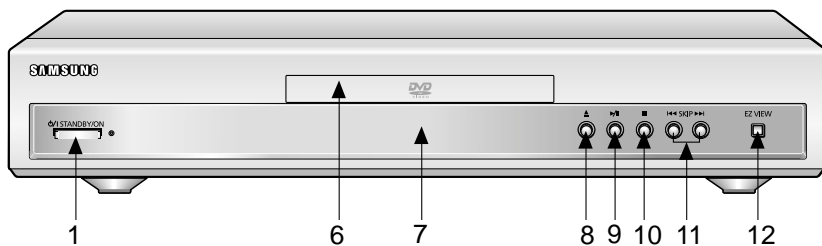

DVD-E338K

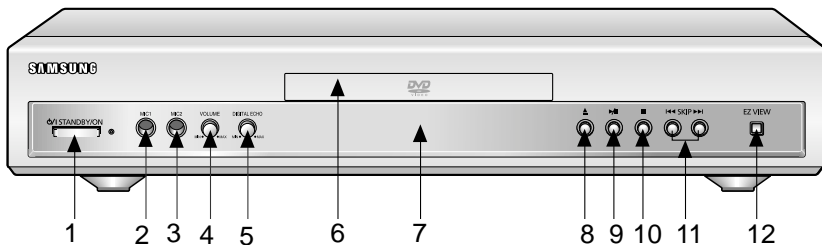

Description-Front Panel

DVD-P538K

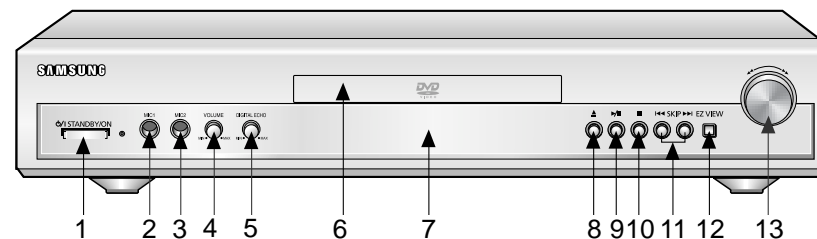

Front Panel Controls

- 1. STANDBY/ON**
 - When the unit is first plugged in, the indicator lights. When STANDBY/ON is pressed on again, the light goes out and the player is turned on.
- 2. MIC 1**
 - Connect microphone 1 for Karaoke functions.
- 3. MIC 2**
 - Connect microphone 2 for Karaoke functions.
- 4. VOLUME**
 - Use to adjust microphone volume level.
- 5. DIGITAL ECHO**
 - Use to adjust echo delay.
- 6. DISC TRAY**
 - Load the disc here.
- 7. DISPLAY**
 - Operation indicators are displayed here.
- 8. OPEN/CLOSE**
 - Press to open and close the disc tray.
- 9. PLAY/PAUSE (▶/⏸)**
 - Begin or pause disc play.
- 10. STOP (■)**
 - Stops disc play.
- 11. SKIP (⏮ / ⏭)**
 - Use to skip a scene or music.
- 12. EZ VIEW**
 - Easy View can convert Letter Box images to full screen viewing on your conventional TV.
- 13. SHUTTLE**
 - Use during DVD and CD play to fast forward or reverse.

Display Indicators

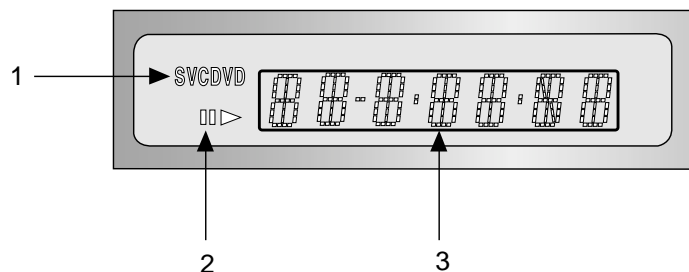

Front Panel Display

1. Disc type indicators
2. Play / Pause / Forward play
3. Displays various messages concerning operations such as PLAY, STOP, LOAD ...
 - no DISC** : No disc loaded.
 - OPEN** : The disc tray is open.
 - LOAD** : Player is loading disc information.

Description-Rear Panel

SETUP

DVD-P538K

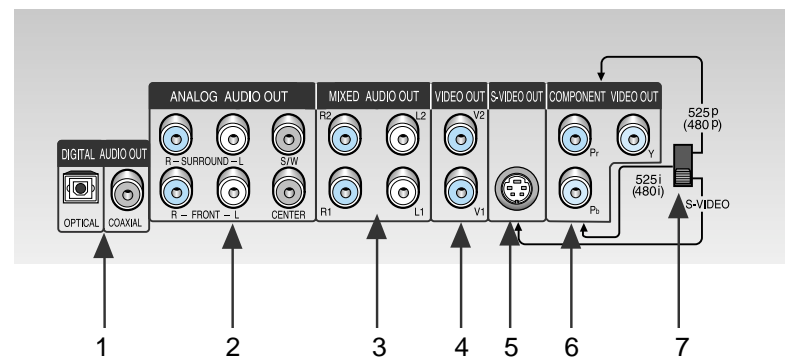

Rear Panel

1. DIGITAL AUDIO OUT JACKS

- Use either an optical or coaxial digital cable to connect to a compatible Dolby Digital receiver.
- Use to connect to an A/V Amplifier that contains a Dolby Digital or DTS decoder.

2. 5.1CH ANALOG AUDIO OUT JACKS

- Connect to an amplifier with 5.1ch analog input jacks.

3. MIXED AUDIO OUT JACKS

- Connect to the Audio input jacks of your television, audio/video receiver.

4. VIDEO OUT JACK

- Use a video cable to connect to the Video input jack on your television.
- The VIDEO OUT SELECT switch must be set to the 525i(480i) or S-VIDEO position.

5. S-VIDEO OUT JACK

- Use the S-Video cable to connect this jack to the S-Video jack on your television for a higher quality picture.
- The VIDEO OUT SELECT switch must be set to the S-VIDEO position.

6. COMPONENT VIDEO OUT JACKS

- Use these jacks if you have a TV with Component Video in jacks. These jacks provide Pr, Pb and Y video. Along with S-Video, Component Video provides the best picture quality.
- If 525P(480P) VIDEO is selected, progressive scan mode will work.
- If 525i(480i) VIDEO is selected, interlaced scan mode will work.

7. VIDEO OUT SELECT SWITCH

- Use this switch to set video out.
- If 525P(480P) VIDEO is selected, VIDEO and S-VIDEO will not work.

Important Note

- Consult your TV User's Manual to find out if your TV supports Progressive Scan. If Progressive Scan is supported, follow the TV User's Manual's instructions regarding Progressive Scan settings in the TV's menu system.
- If 525P(480P) VIDEO OUT is selected, VIDEO and S-VIDEO will not work.
- Select the VIDEO OUT SELECT switch in the Stop or Power Off mode.

Description-Rear Panel

DVD-E138A/DVD-1010/DVD-E138B/DVD-E238

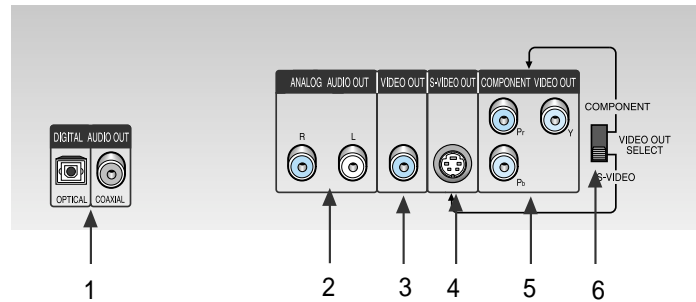

DVD-E338K

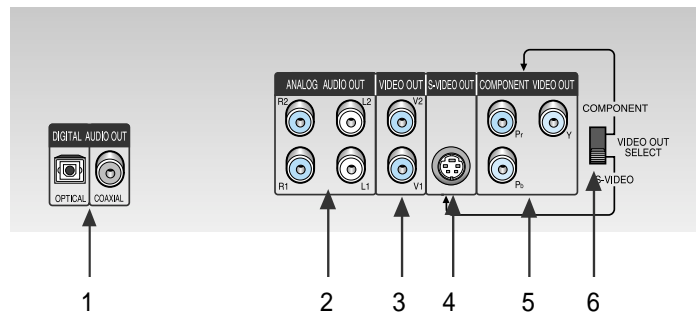

Description-Rear Panel

SETUP

Rear Panel

1. DIGITAL AUDIO OUT JACKS

- Use either an optical or coaxial digital cable to connect to a compatible Dolby Digital receiver. Use to connect to an A/V Amplifier that contains a Dolby Digital or DTS decoder.

2. ANALOG AUDIO OUT JACKS

- Connect to the Audio input jacks of your television, audio/video receiver.

3. VIDEO OUT JACKS

- Use a video cable to connect to the Video input jack on your television.

4. S-VIDEO OUT JACK

- Use the S-Video cable to connect this jack to the S-Video jack on your television for a higher quality picture. The S-Video must be selected in the VIDEO OUT SELECT.

5. COMPONENT VIDEO OUT JACKS

- Use these jacks if you have a TV with Component Video in jacks. These jacks provide Pr, Pb and Y video. Along with S-Video, Component Video provides the best picture quality. The COMPONENT must be selected in the VIDEO OUT SELECT.

6. VIDEO OUT SELECT SWITCH

- Use the switch to set video out. If COMPONENT is selected, S-Video may not work. If S-Video is selected, COMPONENT may not work.

NOTE

- * Select the VIDEO OUT SELECT switch in the Stop or Power Off mode.

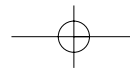

Tour of the Remote Control

DVD-E138A/DVD-1010/DVD-E138B/DVD-E238

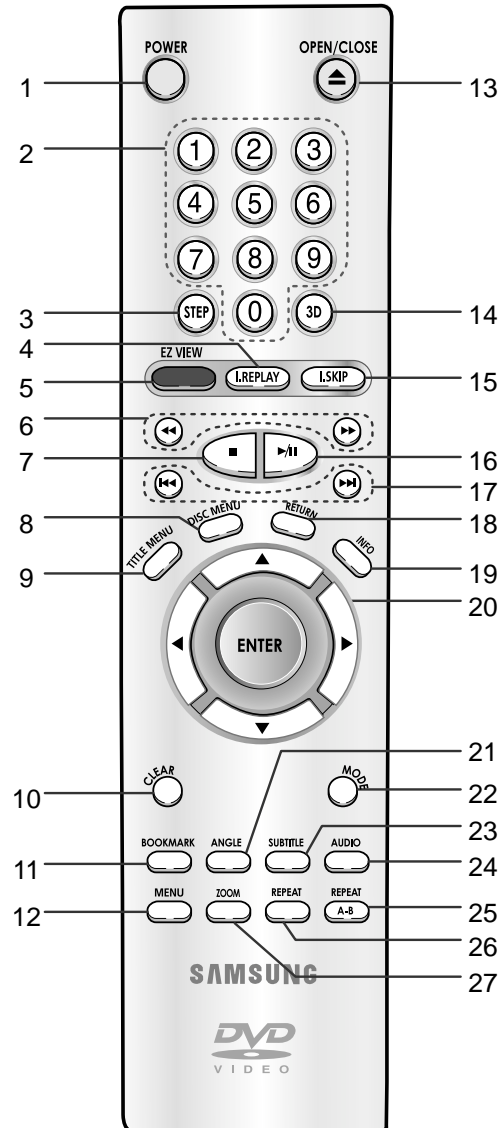

Tour of the Remote Control

SETUP

DVD Function Buttons

- 1. DVD POWER Button**
 - Turns the power on or off.
- 2. NUMBER Buttons**
- 3. STEP Button**
 - Advances play one frame at a time.
- 4. I.REPLAY Button**
 - This function is used to replay the previous 10 seconds of the movie from the current position.
- 5. EZ VIEW Button**
 - Easy View can convert Letter Box images to full screen viewing on your conventional TV.
- 6. SEARCH Buttons (⏮ / ⏭)**
 - Allows you to search forward/backward through a disc.
- 7. STOP Button (■)**
- 8. DISC MENU Button**
 - Brings up the Disc menu.
- 9. TITLE MENU Button**
 - Brings up the Title menu.
- 10. CLEAR Button**
 - Use to remove menus or status displays from the screen.
- 11. BOOKMARK Button**
- 12. MENU Button**
 - Brings up the DVD player's setup menu.
- 13. OPEN/CLOSE Button**
 - To open and close the disc tray.
- 14. 3D Button**
- 15. I.SKIP Button**
 - This function skips playback ahead 10 seconds.
- 16. PLAY/PAUSE Button (▶/⏸)**
 - Begin/Pause disc play.
- 17. SKIP Buttons (⏮ / ⏭)**
 - Use to skip the title, chapter, or track.
- 18. RETURN Button**
 - Returns to a previous menu.
- 19. INFO Button**
 - Displays the current disc mode.
- 20. ENTER/DIRECTION Button (UP/DOWN or LEFT/RIGHT Buttons)**
 - This button functions as a toggle switch.
- 21. ANGLE Button**
 - Use to access various camera angles on a DVD.
- 22. MODE Button**
 - Allows you to program a specific order.
- 23. SUBTITLE Button**
- 24. AUDIO Button**
 - Use this button to access various audio functions on a disc.
- 25. REPEAT A-B Button**
 - Use to mark a segment to repeat between A and B.
- 26. REPEAT Button**
 - Allows you to repeat play a title, chapter, track, or disc.
- 27. ZOOM Button**
 - Enlarges the DVD picture.



Tour of the Remote Control

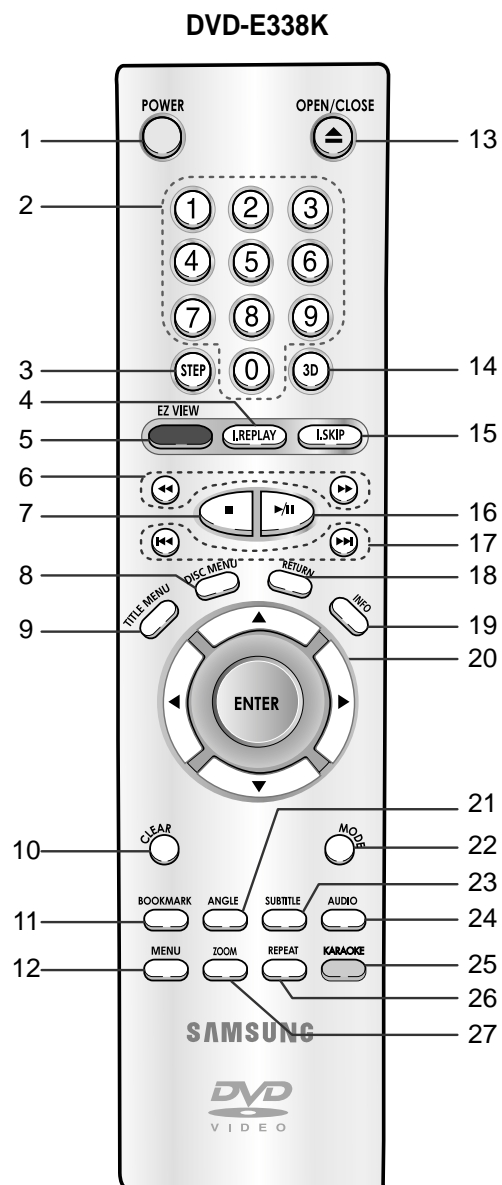

Tour of the Remote Control

DVD Function Buttons

- 1. DVD POWER Button**
 - Turns the power on or off.
- 2. NUMBER Buttons**
- 3. STEP Button**
 - Advances play one frame at a time.
- 4. I.REPLAY Button**
 - This function is used to replay the previous 10 seconds of the movie from the current position.
- 5. EZ VIEW Button**
 - Easy View can convert Letter Box images to full screen viewing on your conventional TV.
- 6. SEARCH Buttons (◀◀ / ▶▶)**
 - Allows you to search forward/backward through a disc.
- 7. STOP Button (■)**
- 8. DISC MENU Button**
 - Brings up the Disc menu.
- 9. TITLE MENU Button**
 - Brings up the Title menu.
- 10. CLEAR Button**
 - Use to remove menus or status displays from the screen.
- 11. BOOKMARK Button**
- 12. MENU Button**
 - Brings up the DVD player's setup menu.
- 13. OPEN/CLOSE Button**
 - To open and close the disc tray.
- 14. 3D Button**
- 15. I.SKIP Button**
 - This function skips playback ahead 10 seconds.
- 16. PLAY/PAUSE Button (▶/||)**
 - Begin/Pause disc play.
- 17. SKIP Buttons (◀◀ / ▶▶)**
 - Use to skip the title, chapter, or track.
- 18. RETURN Button**
 - Returns to a previous menu.
- 19. INFO Button**
 - Displays the current disc mode.
- 20. ENTER/DIRECTION Button (UP/DOWN or LEFT/RIGHT Buttons)**
 - This button functions as a toggle switch.
- 21. ANGLE Button**
 - Use to access various camera angles on a DVD.
- 22. MODE Button**
 - Allows you to program a specific order.
- 23. SUBTITLE Button**
- 24. AUDIO Button**
 - Use this button to access various audio functions on a disc.
- 25. KARAOKE Button**
 - Use to begin Karaoke functions.
- 26. REPEAT Button**
 - Allows you to repeat play a title, chapter, track, or disc.
- 27. ZOOM Button**
 - Enlarges the DVD picture.

Tour of the Remote Control

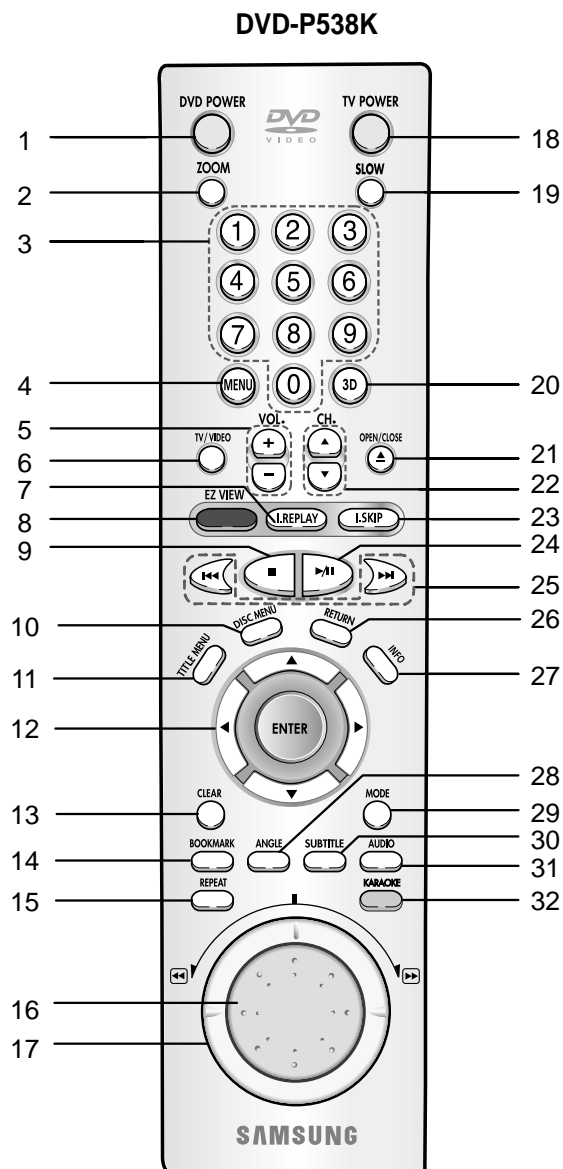

Tour of the Remote Control

DVD Function Buttons

- 1. DVD POWER Button**
 - Turns the power on or off.
- 2. ZOOM Button**
 - Enlarges the DVD picture.
- 3. NUMBER Buttons**
- 4. MENU Button**
 - Brings up the DVD player's setup menu.
- 5. VOLUME Buttons**
- 6. TV/VIDEO Button**
- 7. I.REPLAY Button**
 - This function is used to replay the previous 10 seconds of the movie from the current position.
- 8. EZ VIEW Button**
 - Easy View can convert Letter Box images to full screen viewing on your conventional TV.
- 9. STOP Button (■)**
- 10. DISC MENU Button**
 - Brings up the Disc menu.
- 11. TITLE MENU Button**
 - Brings up the Title menu.
- 12. ENTER/DIRECTION Button (UP/DOWN or LEFT/RIGHT buttons)**
 - This button functions as a toggle switch.
- 13. CLEAR Button**
 - Use to remove menus or status displays from the screen.
- 14. BOOKMARK Button**
- 15. REPEAT Button**
 - Allows you to repeat play a title, chapter, track, or disc.
- 16. JOG DIAL**
 - Operates frame by frame play. In CD mode, performs track search.
- 17. SHUTTLE DIAL**
 - Performs fast motion play.
- 18. TV POWER Button**
- 19. SLOW Button**
- 20. 3D Button**
- 21. OPEN/CLOSE Button**
- 22. CHANNEL Buttons**
- 23. I.SKIP Button**
 - This function skips playback ahead 10 seconds.
- 24. PLAY/PAUSE Button (▶/||)**
 - Begin/Pause disc play.
- 25. SKIP Buttons (◀◀ / ▶▶)**
 - Use to skip the title, chapter, or track.
- 26. RETURN Button**
 - Returns to a previous menu.
- 27. INFO Button**
 - Displays the current disc mode.
- 28. ANGLE Button**
 - Use to access various camera angles on a DVD.
- 29. MODE Button**
 - Allows you to program a specific order.
- 30. SUBTITLE Button**
- 31. AUDIO Button**
 - Use this button to access various audio functions on a disc.
- 32. KARAOKE Button**
 - Use to begin Karaoke functions.

Choosing a Connection

The following show examples of connections commonly used to connect the DVD player with a TV and other components.

Before Connecting the DVD Player

- Always turn off the DVD player, TV, and other components before you connect or disconnect any cables.
- Refer to the owner's manual of the additional components you are connecting for more information on those particular components.

Connection to an Audio System

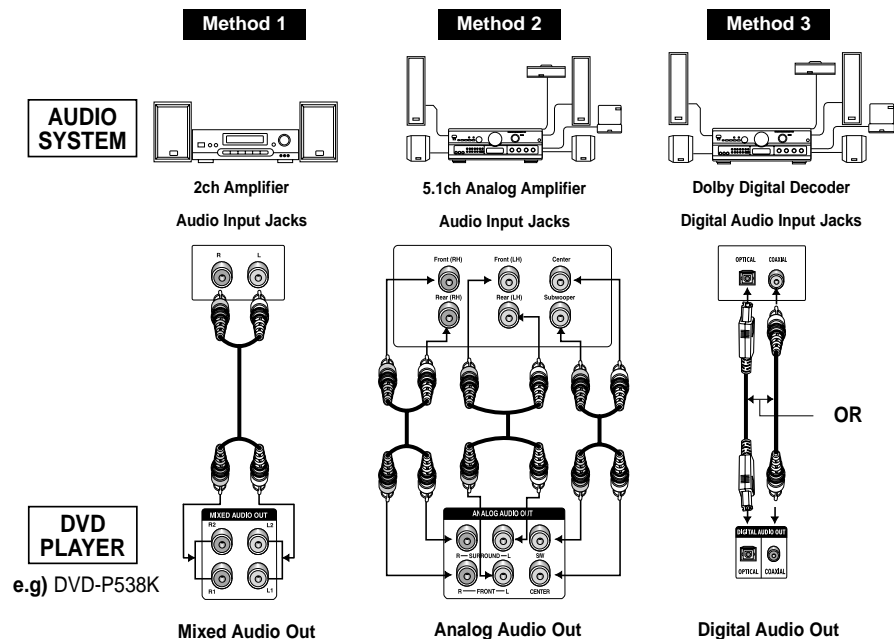

Choosing a Connection (DVD-P538K only)

Connection to a TV (For Video)

TV (Normal, Widescreen, Projection, etc..)

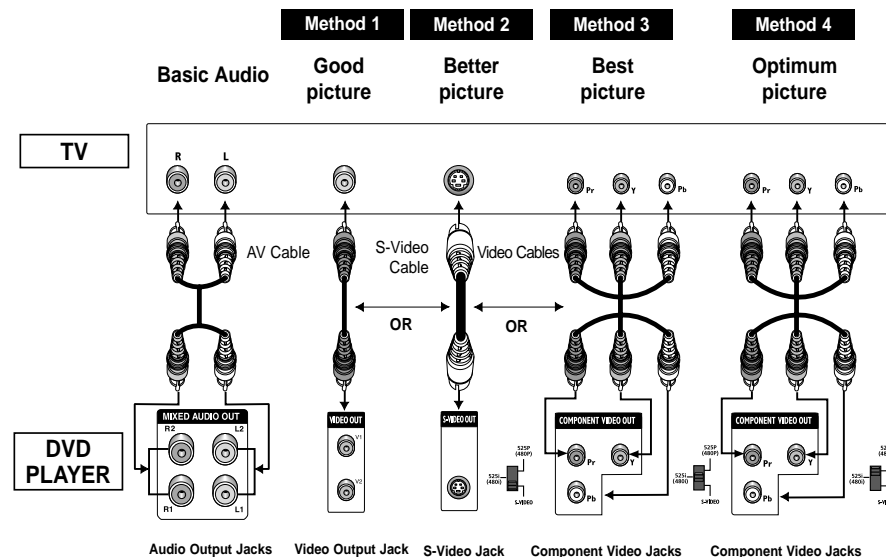

- Method 1** DVD Player + TV with Video Input Jack
(The VIDEO OUT SELECT switch must be set to the S-VIDEO position.)
- Method 2** DVD Player + TV with S-Video Input Jack
(The VIDEO OUT SELECT switch must be set to the S-VIDEO position.)
- Method 3** DVD Player + TV with Component Video Jacks
(The VIDEO OUT SELECT switch must be set to the 525i(480i) position.)
- Method 4** DVD Player + TV with Progressive Scan Jacks.
(The VIDEO OUT SELECT switch must be set to the 525P(480P) position.)
• If 525P(480P) VIDEO OUT is selected, VIDEO and S-VIDEO will not work.
• Depending on your TV, your hookup for Method 4 may differ from the illustration.

Important Note

Consult your TV User's Manual to find out if your TV supports Progressive Scan. If Progressive Scan is supported, follow the TV User's Manual's instructions regarding Progressive Scan settings in the TV's menu system.

Choosing a Connection (DVD-E138A/DVD-1010/DVD-E138B/DVD-E238/DVD-E338K only)

Connection to a TV (For Video)

TV (Normal, Widescreen, Projection, etc..)

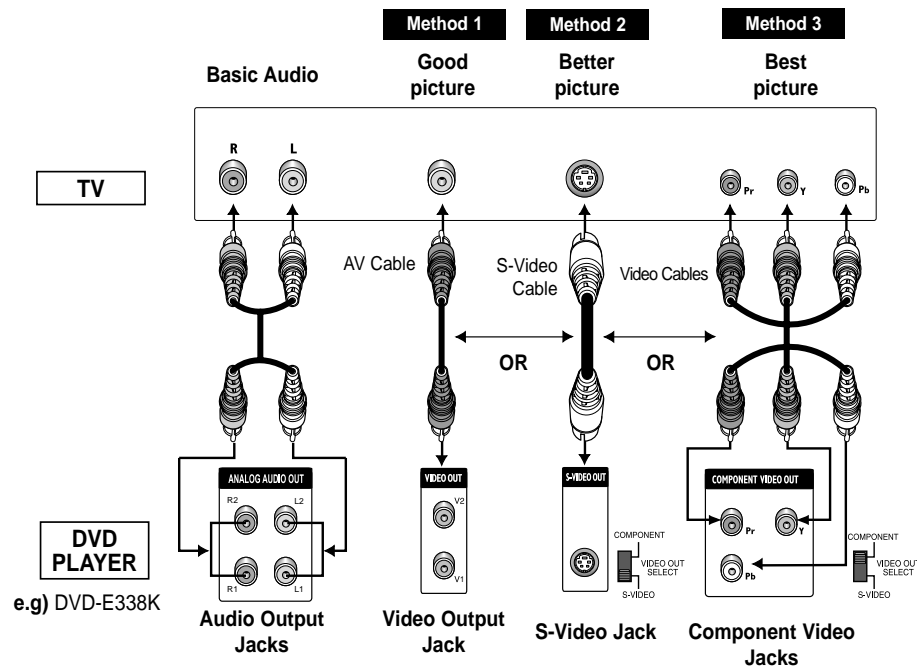

e.g) DVD-E338K

Method 1 DVD Player + TV with Video Input Jack

Method 2 DVD Player + TV with S-Video Input Jack
(If S-Video is selected in the VIDEO OUT SELECT.)

Method 3 DVD Player + TV with Component Video Jacks
(If COMPONENT is selected in the VIDEO OUT SELECT.)

NOTE

- If COMPONENT is selected, S-Video will not work.
- If S-Video is selected, COMPONENT will not work.

Playing a Disc

Before Play

- Turn on your TV and press the TV/VIDEO button to select the video mode.
- Turn on your Audio System and select AUX, CD or DVD.

After plugging in the player, the first time you press the DVD POWER button, this screen comes up :

If you want to select the language, press a NUMBER button.
(This screen will only appear the very first time you plug in the player.)



Play

- 1 Press the OPEN/CLOSE button.
The STANDBY indicator light goes out and the tray opens.
- 2 Place a disc gently into the tray with the disc's label facing up.
- 3 Press the PLAY/PAUSE (▶/||) button or OPEN/CLOSE button to close the disc tray.
- 4 Stopping Play
Press the STOP (■) button during play.
- 5 Removing Disc
Press the OPEN/CLOSE button.
- 6 Pausing Play
Press the PLAY/PAUSE (▶/||) or STEP button on the remote during play.
- Screen stops, no sound.
- To resume again, press PLAY/PAUSE (▶/||) button once again.

Playing a Disc

7 Step Motion Play (Except CD)

DVD-P538K : If turning Jog Dial, you can view one by one.

DVD-E138A/DVD-1010/DVD-E138B/DVD-E238/DVD-E338K : Press the STEP button on the remote during play.

- Each time the button is pressed, a new frame will appear.

- No sound is heard during STEP mode.

- Press PLAY/PAUSE (▶/||) to resume normal play.

(You can only perform step motion play in the forward direction.)

8 Slow Motion Play (Except CD)

DVD-E138A/DVD-1010/DVD-E138B/DVD-E238/DVD-E338K : Press the ►► button on the remote during PAUSE or STEP mode. By pressing the ►► button, you can select slow motion play for 1/8, 1/4 or 1/2 of normal speed.

DVD-P538K : Press and hold the ►► button to choose the play speed between 1/8X, 1/4X and 1/2X of normal during PAUSE or STEP mode, or press the SLOW button you can play slow motion for 1/8 of normal speed.

- No sound is heard during slow mode.

- Press PLAY/PAUSE (▶/||) to resume normal play.

- When playing a DVD/VCD, reverse slow motion play will not work.

RESUME function

When you stop disc play, the player remembers where you stopped, so when you press PLAY (▶/||) again, it will pick up where you left off. (unless the disc is removed, the STOP (■) button is pressed twice or the player is unplugged.)

NOTE

- If the player is left for 5 minutes in pause mode, it will stop.
- If the player is left in the stop mode for more than 30 minutes, the power will automatically shut off. (Automatic Power-Off Function) (DVD-E138A/DVD-1010/DVD-E138B/DVD-E238 only)
- If the player is left in the stop mode for more than one minute without any user interaction, a screen saver will be activated, and the TV screen will fade in and out repeatedly. Press the PLAY (▶/||) button to resume normal play.
- This  icon indicates an invalid button press.

Using the Search & Skip Functions

During play, you can search quickly through a chapter or track or use the skip function to jump to the next selection.

Searching through a Chapter or Track

1 DVD-E138A/DVD-1010/DVD-E138B/DVD-E238/DVD-E338K : Press the ◀◀ or ▶▶ button on the remote and press again to search at a faster speed on the DVD, VCD, CD.

DVD-P538K : Turn the shuttle dial of remote control during disc play.

Turn the shuttle dial on the front can a multiple-speed operation if desiring to use the key on the front.

DVD	2X, 4X, 8X, 16X, 32X, 128X
VCD	4X, 8X
CD	2X, 4X, 8X

Skipping Tracks

1 During play, press the ◀◀ or ▶▶ button.

- When playing a DVD, if you press the ▶▶ button, it moves to the next chapter. If you press the ◀◀ button, it moves to the beginning of the chapter. One more press makes it move to the beginning of the previous chapter.
- When playing a VCD 2.0 in MENU OFF mode, a VCD 1.1 or a CD, if you press the ▶▶ button, it moves to the next track. If you press the ◀◀ button, it moves to the beginning of the track. One more press makes it move to the beginning of the previous track.
- If a track exceeds 15 minutes when playing a VCD and you press the ▶▶ button, it moves forward 5 minutes. If you press the ◀◀ button, it moves backward 5 minutes.

Using the Display Function

When Playing a DVD/VCD/CD

- 1 During play, press the INFO button on the remote.
- 2 Use the UP/DOWN buttons to select the desired item.
- 3 Use the LEFT/RIGHT buttons to make the desired setup, then press ENTER.
 - You may use the number buttons of the remote control to directly access a title, chapter or to start the playback from the desired time.
- 4 To make the screen disappear, press the INFO button again.



To access the desired title when there is more than one in the disc. For example, if there is more than one movie on a DVD, each movie will be identified.



Most of DVD discs are recorded in chapters so that you can quickly find a specific passage. (similar to tracks on an audio CD).



Allows playback of the film from a desired time. You must enter the starting time as a reference.



Refers to the language of the film soundtrack. In the example, the soundtrack is played in English 5.1CH. A DVD disc can have up to eight different soundtracks.



Refers to the subtitle languages available in the disc. You will be able to choose the subtitles language or, if you prefer, turn them off from the screen. A DVD disc can have up to 32 different subtitles.



A surround sound effect is generated using only two front speakers.

NOTE

- When in VCD 2.0 mode (MENU ON mode), this function does not work. Using DISC MENU button in VCD 2.0, select Menu On/Off.

DVD



VCD

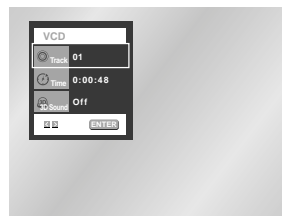

CD



Using the Disc and Title Menu

Using the Disc Menu

- 1 During the playback of a DVD disc, press the MENU button on the remote.
- 2 Select **Disc Menu** using the UP/DOWN buttons, then press the RIGHT or ENTER button.



Using the Title Menu

- 1 During the playback of a DVD disc, Press the MENU button on the remote.
- 2 Select **Title Menu** using the UP/DOWN buttons, then press the RIGHT or ENTER button.



NOTE

- Depending on the disc, the Title and Disc Menus may not work.
- Title Menu will only be displayed if there are at least two titles in the disc.
- You can also use the Title Menu and the Disc Menu, using the TITLE MENU and the DISC MENU buttons on the remote.
- In VCD2.0, the DISC MENU button works as a conversion switch between Menu On and Menu Off mode.

Using the Function Menu

Using the Function Menu

- 1 Press the MENU button during playback.
- 2 Use the UP/DOWN buttons to highlight **Function**, then press the RIGHT or ENTER button.
- 3 Function selection screen appears, Info, Zoom, Bookmark, Repeat and EZ View.
 - Info (See Page 26)
 - Zoom (See Page 38)
 - Bookmark (See Page 37)
 - Repeat (See Page 29)
 - EZ View (See Page 30-31)
- 4 Use the UP/DOWN button to highlight one of the 5 functions. Then press the RIGHT or ENTER button to access the function.



NOTE

- You can also directly select these functions using their respective buttons on the remote.

Repeat Play

Repeat the current track, chapter, title, a chosen section (A-B), or all of the disc.

When playing a DVD

- 1 Press the REPEAT button on the remote. Repeat screen appears.
- 2 Select Chapter, Title or A-B using the LEFT/RIGHT buttons.
 - REPEAT A-B
 - Press the REPEAT button. Select A-B on screen with the LEFT/RIGHT buttons or press the REPEAT A-B (DVD-E138A/DVD-1010/DVD-E138B/DVD-E238 only) button on the remote.
 - Press ENTER at the point where you want the repeat play to start (A). The B is automatically highlighted.
 - Press ENTER at the point where you want the repeat play to stop (B).
 - To terminate the function, press the CLEAR button or the REPEAT A-B (DVD-E138A/DVD-1010/DVD-E138B/DVD-E238 only) button again.
 - A-B REPEAT does not allow you to set point (B) until at least 5 seconds has elapsed after point (A) has been set.
- 3 Press ENTER.
- 4 To return to normal play, press REPEAT again, then press the LEFT/RIGHT buttons to select Off. Press ENTER, then press the PLAY/PAUSE (▶/II) button.

NOTE

- DVD repeats play by chapter or title, CD and VCD repeat play by disc or track.
- Depending on the disc, the Repeat function may not work.
- When in VCD 2.0 mode (MENU ON mode), this function does not work.

DVD

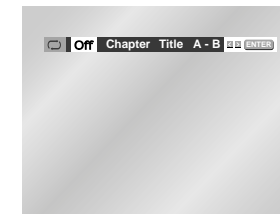

VCD/CD

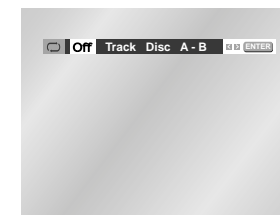

BASIC
FUNCTIONS

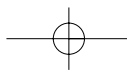

Adjusting the Aspect Ratio (EZ View)

To play back using aspect ratio (DVD)

- 1 Press the EZ VIEW button.
 - The screen size changes when the button is pressed repeatedly.
 - The screen zoom mode operates differently depending on the screen setting in the initial setup menu.
 - To ensure correct operation of the EZ VIEW button, you should set the correct aspect ratio in the initial setup (See page 53).

If you are using a 16:9 TV

1 For 16:9 aspect ratio discs

- **Wide Screen**
Displays the content of the DVD title in 16:9 aspect ratio.
- **Screen Fit**
The top and bottom of the screen are cut off. When playing a 2.35:1 aspect ratio disc, the black bars at the top and bottom of the screen will disappear. The picture will look vertically stretched. (Depending on the type of disc, the black bars may not disappear completely.)
- **Zoom Fit**
The top, bottom, left and right of the screen are cut off and the central portion of the screen is enlarged.

2 For 4:3 aspect ratio discs

- **Normal Wide**
Displays the content of the DVD title in 16:9 aspect ratio. The picture will look horizontally stretched.
- **Screen Fit**
The top and bottom of the screen are cut off and the full screen appears. The picture will look vertically stretched.
- **Zoom Fit**
The top, bottom, left and right of the screen are cut off and the central portion of the screen is enlarged.
- **Vertical Fit**
When a 4:3 DVD is viewed on a 16:9 TV, black bars will appear at the left and right of the screen in order to prevent the picture from looking horizontally stretched.

Adjusting the Aspect Ratio (EZ View)

If you are using a 4:3 TV

1 For 16:9 aspect ratio discs

- **4:3 Letter Box**
Displays the content of the DVD title in 16:9 aspect ratio. The black bars will appear at the top and bottom of the screen.
- **4:3 Pan Scan**
The left and right of the screen are cut off and displays the central portion of the 16:9 screen.
- **Screen Fit**
The top and bottom of the screen are cut off and the full screen appears. The picture will look vertically stretched.
- **Zoom Fit**
The top, bottom, left and right of the screen are cut off and the central portion of the screen is enlarged.

2 For 4:3 aspect ratio discs

- **Normal Screen**
Displays the content of the DVD title in 4:3 aspect ratio.
- **Screen Fit**
The top and bottom of the screen are cut off and the full screen appears. The picture would look vertically stretched.
- **Zoom Fit**
The top, bottom, left and right of the screen are cut off and the central portion of the screen is enlarged.

NOTE

- This function may behave differently depending on the type of disc.

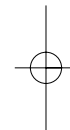

Slow Repeat play

This feature allows you slowly repeat scenes containing sports, dancing, musical instruments being played etc. so you can study them more closely.

When playing a DVD

- 1 During play, press the PLAY/PAUSE (▶/⏸) button.
- 2 Press and hold the ▶▶ button to choose the play speed between 1/8X, 1/4X and 1/2X of normal. (DVD-P538K only)
Press the ▶▶ button to choose the play speed between 1/8X, 1/4X and 1/2X of normal. (DVD-E138A/DVD-1010/DVD-E138B/DVD-E238/DVD-E338K only)
- 3 Press the REPEAT or REPEAT A-B(DVD-E138A/DVD-1010/DVD-E138B/DVD-E238 only) button to select the point where the function starts. (A) (See Page 29)
- 4 Press the REPEAT or REPEAT A-B(DVD-E138A/DVD-1010/DVD-E138B/DVD-E238 only) button to select the point where the function ends. (B) (See Page 29)

NOTE

- The disc will play from A to B repeatedly at the speed you chose.
- To terminate the function, press the CLEAR button or the REPEAT or REPEAT A-B(DVD-E138A/DVD-1010/DVD-E138B/DVD-E238) button again.
- A-B REPEAT does not allow you to set point (B) until at least 5 seconds has elapsed after point (A) has been set.

Selecting the Audio Language

You can select a desired language quickly and easily with the AUDIO button.

Using the AUDIO button

- 1 Press the AUDIO button.
- 2 Use the LEFT/RIGHT buttons to select the desired language on a DVD.
- The audio languages are represented by abbreviations.
- 3 Use the LEFT/RIGHT buttons to select Stereo, LEFT or RIGHT. (On VCD/CD)

DVD



VCD/CD

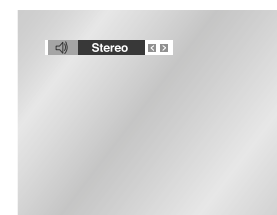

ADVANCED
FUNCTIONS

NOTE

- This function depends on what languages are encoded on the disc and may not work with all DVDs.
- A DVD disc can contain up to 8 audio languages.
- **How to have the same audio language come up whenever you play a DVD;**
Refer to "Setting Up the Language Features" on page 49.

Selecting the Subtitle Language

You can select a desired subtitle quickly and easily with the SUBTITLE button.

Using the SUBTITLE button

- 1 Press the SUBTITLE button.
- 2 Use the LEFT/RIGHT buttons to select the desired subtitle language.
- 3 Use the UP/DOWN buttons to determine whether or not the subtitle will be displayed.

- Initially, the subtitling will not appear on screen.
- The subtitle languages are represented by abbreviations.



Changing the Subtitle color (DVD-P538K only)

- 1 Press the MODE button to change the subtitle color only when the player is in progressive video mode.

NOTE

- This function depends on what languages are encoded on the disc and may not work with all DVDs.
- A DVD disc can contain up to 32 subtitle languages.
- **How to have the same subtitle language come up whenever you play a DVD;**
Refer to "Setting Up the Language Features" on page 49.

Changing the Camera Angle

When a DVD contains multiple angles of a particular scene, you can select the Angle function.

Using the ANGLE button

Press the ANGLE button to see if an ANGLE () mark is present at the upper left hand corner of the screen.

- 1 When an ANGLE mark is shown, press the ANGLE button, then an ANGLE select icon will appear at the upper left hand corner of the screen.
- 2 Use the LEFT/RIGHT buttons to select the desired screen angle.
- 3 To turn off the display, press the ANGLE button again.



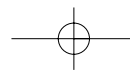

Using the Instant Replay/Skip Function

Using the Instant Replay function (DVD)

If you miss a scene, you can see it again using this function.

- 1 If you press the I.REPLAY button, the current scene moves backward about 10 seconds, and plays back.

- Depending on the disc, the Instant Replay function may not work.

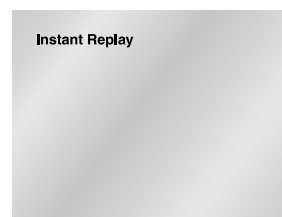

Using the Instant Skip function (DVD)

Use this function to skip playback 10 seconds ahead of the current scene.

- 1 Press the I.SKIP button.

- Playback will skip ahead 10 seconds.
- Depending on the disc, this feature may not work.

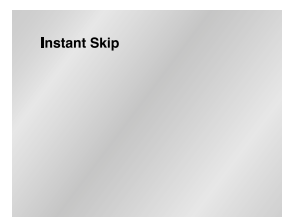

Using the Bookmark Function

This feature lets you bookmark sections of a DVD or VCD (MENU OFF mode) so you can quickly find them at a later time.

Using the Bookmark Function (DVD/VCD)

- 1 During play, press the BOOKMARK button on the remote. The Bookmark icons will be displayed.
- 2 Use the LEFT/RIGHT buttons to move to the desired bookmark icon.
- 3 When you reach the scene you want to mark, press the ENTER button. The icon will change to a number (1, 2, or 3).
- 4 Press the BOOKMARK button to turn off the display.



Recalling a Marked Scene

- 1 During play, press the BOOKMARK button on the remote.
- 2 Use the LEFT/RIGHT buttons to select a marked scene.
- 3 Press the PLAY/PAUSE (▶/⏸) buttons to skip to the marked scene.

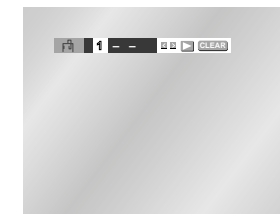

Clearing a Bookmark

- 1 During play, press the BOOKMARK button on the remote.
- 2 Use the LEFT/RIGHT buttons to select the bookmark number you want to delete.
- 3 Press the CLEAR button to delete a bookmark number. Press the BOOKMARK button to turn off the display.

NOTE

- Up to three scenes may be marked at a time.
- When in VCD 2.0 mode (MENU ON mode), this function does not work.
- Depending on the disc, the Bookmark function may not work.

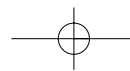

Using the Zoom & 3D Sound Functions

Using the Zoom Function (DVD)

- 1 During play or pause mode, press the ZOOM button on the remote.
A zoom mark will be displayed on screen.
- 2 Use the UP/DOWN or LEFT/RIGHT buttons to select the part of the screen you want to zoom in on.
- 3 Press the ENTER button.
 - During DVD play, press ENTER to zoom in 2X/4X/2X/Normal in order.
 - During VCD play, press ENTER to zoom in 2X/Normal in order.

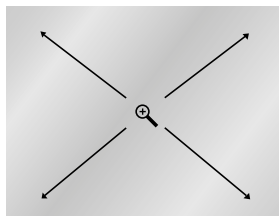

Using the 3D Sound Function

The simulated surround effect depends on the disc contents. If you connect the unit to your stereo system, you can enhance sound quality and produce a greater surround effect. This feature is useful when you are using the DVD player with a two channel stereo through the analog outputs. (Discs which are recorded with LPCM or DTS will not work.)

- 1 During play, press the 3D button. The 3D SOUND mark will be displayed on screen.
- 2 Press the UP/DOWN buttons to turn the 3D Sound feature on or off.

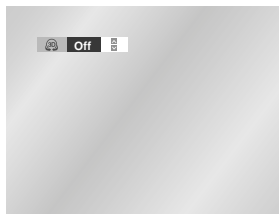

NOTE

- 3D Sound is possible only on discs recorded using DOLBY SURROUND or DOLBY DIGITAL. However, some of these discs do not contain rear channel sound signals.
- Depending on the disc, the Zoom and 3D Sound functions may not work.

MP3/WMA Play

When an MP3/WMA Disc is inserted into the DVD player, the first song file of the first folder plays.

- If more than two file extensions are present, select the media of your choice by pressing UP/DOWN, then press the ENTER button.
- To change the currently playing media, press the STOP (■) button twice and then press the DISC MENU button.
- If no button on the remote controller is pressed for 60 seconds, the menu will disappear and the selected item will be played.

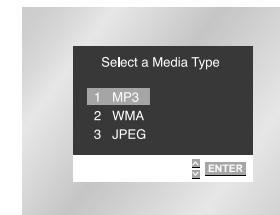

MP3/WMA Play Function

- 1 When the first song file is playing, the music folder menu will appear on the right side of the screen. Up to 8 music folders can be displayed at a time. If you have more than 8 folders on a disc, press the LEFT/RIGHT buttons to bring them up on the screen.
- 2 Use the UP/DOWN buttons to select the desired music folder, then press ENTER. Use the UP/DOWN buttons again to select a song file. Press ENTER to begin playback of the song file.

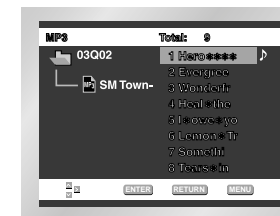

ADVANCED
FUNCTIONS

Program/Random playback

Press the MODE button to switch between the PROGRAM and RANDOM modes. See page 41 for more information on these modes.



NOTE

- Press the REPEAT button to hear only music continuously and press it once again to release.
- PROGRAM/RANDOM playback cannot be used if the disc contains more than two types of file extensions.

MP3/WMA Play

CD-R MP3/WMA discs

When playing CD-R/MP3 or WMA discs, please follow all the recommendations for CD-R above, plus the comments below:

- **Your MP3 or WMA files should be ISO 9660 or JOLIET format.**
ISO 9660 format and Joliet MP3 or WMA files are compatible with Microsoft's DOS and Windows, and with Apple's Mac. These two formats are the most widely used.
- **When naming your MP3 or WMA files do not exceed 8 characters, and place ".mp3, .wma" as the file extension.**
General name format: Title.mp3, or Title.wma. When composing your title, make sure that you use 8 characters or less, have no spaces in the name, and avoid the use of special characters including: (.,\,/,=,+).
- **Use a decompression transfer rate of at least 128 Kbps when recording MP3 files.**
Sound quality with MP3 files basically depends on the rate of compression/decompression you choose. Getting audio CD quality sound requires an analog/digital sampling rate, that is conversion to MP3 format, of at least 128 Kbps and up to 160 Kbps. However, choosing higher rates, like 192 Kbps or more, only rarely give better sound quality.
Conversely, files with decompression rates below 128 Kbps will not be played properly.
- **Use a decompression transfer rate of at least 64Kbps when recording WMA files.**
Sound quality with WMA files basically depends on the rate of compression/decompression you choose. Getting audio CD quality sound requires an analog/digital sampling rate, that is conversion to WMA format, of at least 64Kbps and up to 192Kbps.
Conversely, files with decompression rates below 64Kbps or over 192Kbps will not be played properly.
- **Do not try recording copyright protected MP3 files.**
Certain "securized" files are encrypted and code protected to prevent illegal copying. These files are of the following types: Windows Media™ (registered trade mark of Microsoft Inc) and SDMI™ (registered trade mark of The SDMI Foundation). You cannot copy such files.
- **Important:** The above recommendations cannot be taken as a guarantee that the DVD player will play MP3 recordings, or as an assurance of sound quality.
You should note that certain technologies and methods for MP3 file recording on CD-Rs prevent optimal playback of these files on your DVD player (degraded sound quality and in some cases, inability of the player to read the files).
- This unit can play a maximum of 500 files and 300 folders per disc.

Program Play & Random Play

Program Play (CD/MP3/WMA)

- 1 Press the MODE button.
- 2 Use the LEFT/RIGHT buttons to select PROGRAM. Press the ENTER button.
- 3 Use the UP/DOWN/LEFT/RIGHT buttons to select the first track to add to the program. Press the ENTER button. The selection numbers appear in the Program Order box.
- 4 Press the PLAY/PAUSE (▶/||) button.
The disc will be played in programmed order.

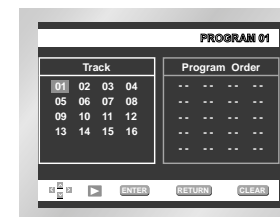

Random Play (CD/MP3/WMA)

- 1 Press the MODE button.
- 2 Use the LEFT/RIGHT buttons to select RANDOM. Press the ENTER button.
The disc will be played in random order.

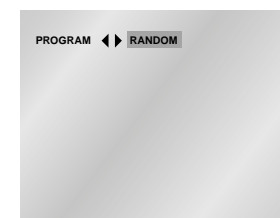



NOTE

- Depending on the disc, the Program and Random Play functions may not work.
- To resume normal play, press the CLEAR button.
- PROGRAM/RANDOM playback cannot be used if the disc contains more than two types of file extensions.
- This unit can support a maximum of 99 programmed order.

Picture CD Playback

- 1 Open the disc tray.
 - 2 Load the disc on the tray.
- Load the disc with the labeled side up.
 - 3 Close the tray.
- The tray closes and you should get a screen that looks like the one to the right.
- Select JPEG in the menu to view a Photo CD.
 - Use the UP/DOWN or LEFT/RIGHT buttons on the remote controller to select the picture you want to view and then press the ENTER button. (Press the PLAY/PAUSE (▶/⏸) button if you want to play it in the Slide Show mode.)
 - To see the next 6 pictures, press the ►► button.
 - To see the previous 6 pictures, press the ◀◀ button.

-  : Return to the Album Screen.
Press the UP/DOWN or LEFT/RIGHT buttons on the remote controller to display the menu again.



-  : Each time the ENTER button is pressed, the picture rotates 90 degrees clockwise.

-  : Each time the ENTER button is pressed, the picture is enlarged up to 4X. (Normal → 2X → 4X → 2X → Normal)

-  : The unit enters slide show mode.

*Press the RETURN button to return to the album screen.

*Before the Slide Show can begin, the picture interval must be set.

-  : When this icon is selected and ENTER is pressed, the pictures change automatically with about a 6 second interval.
-  : The pictures change automatically with about a 12 second interval.
-  : The pictures change automatically with about an 18 second interval.

*Depending on the file size, each interval between images may take longer or shorter than the manual suggests.

- To change the currently playing media, press the STOP (■) button twice and then press the DISC MENU button.
- If no button on the remote controller is pressed for 60 seconds, the menu will disappear and the selected item will be played.

NOTE

- Press the TITLE MENU button to return to the album screen.
- Press the RETURN button to return to the slide show.
- If no buttons on the remote controller pressed for 10 seconds, the menu will disappear.
Press the UP/DOWN or LEFT/RIGHT buttons on the remote controller to display the menu again.

Picture CD Playback

CD-R JPEG Discs

- Only files with the ".jpg" and ".JPG" extensions can be played.
- If the disc is not closed, it will take longer to start playing and not all of the recorded files may be played.
- Only CD-R discs with JPEG files in ISO 9660 or Joliet format can be played.
- The name of the JPEG file may not be longer than 8 characters and should contain no blank spaces or special characters (. / = +).
- Only a consecutively written multisession disc can be played. If there is a blank segment in the multisession disc, the disc can be played only up to the blank segment.
- A maximum of 500 images can be stored on a single CD.
- Only Kodak Picture CDs can be played.
- When playing a Kodak Picture CD, only the JPEG files in the pictures folder can be played.
- Picture discs other than Kodak Picture CD may take longer to start playing or may not play at all.
- If a number of files in 1 Disc is over 500, only 500 JPEG file can be played.
- If a number of folders in 1 Disc is over 300, only JPEG files in 300 folders can be played.

Beginning Karaoke Functions (DVD-E338K/DVD-P538K only)

Operation Sequence

- 1 Connect the Mixed Audio Out terminals with the TV or AMP.
- 2 Connect Mic into Mic 1 or Mic 2 jack.
- When the MIC should be connected, karaoke function can operate.

Key Control

- 1 Press the KARAOKE button.
- 2 Select the "Keycon" using the LEFT/RIGHT buttons.
- 3 By use of the LEFT/RIGHT buttons, change to the desired tone.
b : To let 7 scales down by half scale.
h : Original scale.
: To let 7 scales up by half scale.

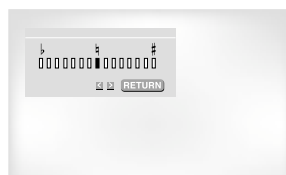
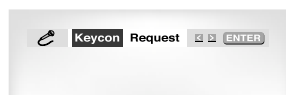

NOTE

- If you hear strange noises(squealing or howling) while using the karaoke feature, move the microphone away from the speakers. Turning down the microphone volume or the speaker volume is also effective.
- The next music plays if performing SEARCH with SCORE displayed in the Score On MODE for CD or VCD.
- When playing MP3 disc, MIC & Karaoke functions are not operate.
- When playing LPCM disc, karaoke functions are not operate.
- When the MIC is connected, Digital Out does not work.

Reserving a Song (DVD-E338K/DVD-P538K only)

It is the function to reserve the desired song in advance by use of Karaoke function

Sequence of reservation

- 1 Playback the Karaoke Disc containing the wanted songs.
- 2 Press the KARAOKE button.
- 3 Select the "Request" using the LEFT/RIGHT buttons.
- 4 Input the number (Track No.) of the desired song into the flickering part(--).
- You can reserve up to 10 songs.
- 5 When you want the next reserved song during playing a song, press the SKIP button.

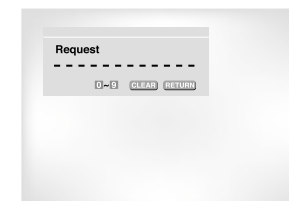
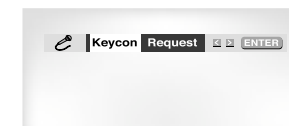

Cancellation of reservation

- 1 Cancel by pressing the CLEAR button of the remote.
- The last reserved song will be erased first.
- 2 Continuous pressing of the CLEAR button can cancel the next reserved song.
- 3 If the reservation is required again, input the song number in the flickering part.

NOTE

- When using "SKIP" button, it can not work at the last song.
- When using Request function, the "DISPLAY" and "REPEAT" function does not work.

Vocal Function (DVD-E338K/DVD-P538K only)

Sequence of reservation

- 1 Pressing the KARAOKE button twice displays the following:



Vocal Fader

- The function to make the music only sound by cancelling vocal when playing a Karaoke disc.

	VOCAL FADER	Remark
↓	V1	CH1. Vocal Cancel
↓	V2	CH2. Vocal Cancel
↓	1 + 2	CH1, CH2. Vocal Cancel
↓	OFF	Vocal Fader Off

- In VCD, CVD or CD, you can select only the On or Off.

Guide Melody

- To guide melody through xylophone and piano help you sing easily.
- This function works only on the DVD Karaoke disc on which the guide melody is recorded.

Score Function

- Press KARAOKE button twice to turn the Score Mode On.
- Score will pop up whenever a song is completed.

CAUTIONS

- Make sure to disconnect MIC to play a movie disc or play in a general mode. If you play a movie disc with the Score On, a score will show up every time when a chapter is over.

Types of Karaoke disc

• DVD Karaoke Disc

Channel	Karaoke -Channel	5CH. DVD	2CH. DVD
1 CH	L	Left stereo music	Left stereo music + Vocal
2 CH	R	Right stereo music	Right stereo music + Vocal
3 CH	M	Guide melody	-
4 CH	V1	Vocal track	-
5 CH	V2	Vocal track	-

• CVD, VCD Karaoke Disc

Channel	Karaoke -Channel	CVD	VCD, CD
1 CH	CH1 LEFT	Left stereo music + Vocal	Left stereo music
1 CH	CH1 RIGHT	Right stereo music + Vocal	Right stereo music + Vocal
2 CH	CH2 LEFT	Left stereo music	-
2 CH	CH2 RIGHT	Right stereo music	-

Using the Setup Menu

The Setup menu lets you customize your DVD player by allowing you to select various language preferences, set up a parental level, even adjust the player to the type of television screen you have.

- 1 With the unit in Stop mode, press the MENU button on the remote. Select **Setup** using UP/DOWN buttons, then press the RIGHT or ENTER button.



- ❶ **Language Setup** : Setup of the Language.
- ❷ **Audio Setup** : Setup of the Audio Options
- ❸ **Display Setup** : Setup of the Display Options
Use to select which type of screen you want to watch and several display options.
- ❹ **Parental Setup** : Setup of the Parental Level
Allows users to set the level necessary to prevent children from viewing unsuitable movies such as those with violence, adult subject matter, etc.

- 2 Use the UP/DOWN buttons on the remote to access the different features.

- 3 Press the ENTER button to access the sub features.

To make the setup screen disappear after setting up, press the MENU button again.

NOTE

Depending on the disc, some Setup Menu selections may not work.

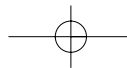

Setting Up the Language Features

If you set the player menu, disc menu, audio and subtitle language in advance, they will come up automatically every time you watch a movie.

Using the Player Menu Language

- 1 With the unit in Stop mode, press the MENU button.
- 2 Select **Setup** using UP/DOWN buttons, then RIGHT or ENTER button.
- 3 Select **Language Setup** using UP/DOWN buttons, then press the RIGHT or ENTER button.
- 4 Select **Player Menu** using UP/DOWN buttons, then press the RIGHT or ENTER button.
- 5 Use the UP/DOWN buttons to select '**English**'.
- 6 Press the ENTER button.
 - English is selected and the screen returns to SETUP menu.
 - To make the SETUP menu disappear, press the RETURN or LEFT button.

e.g) Setting up in English.

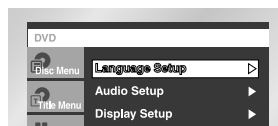

Using the Disc Menu Language

This function changes the text language only on the disc menu screens.

- 1 With the unit in Stop mode, press the MENU button.
- 2 Select **Setup** using UP/DOWN buttons, then RIGHT or ENTER button.
- 3 Select **Language Setup** using UP/DOWN buttons, then press the RIGHT or ENTER button.
- 4 Select **Disc Menu** using UP/DOWN buttons, then press the RIGHT or ENTER button.
- 5 Use the UP/DOWN buttons to select '**English**'.
 - Select "Others" if the language you want is not listed.
- 6 Press the ENTER button.
 - English is selected and the screen returns to SETUP menu.

e.g) Setting up in English.



Setting Up the Language Features

Using the Audio Language

- 1 With the unit in Stop mode, press the MENU button.
- 2 Select **Setup** using UP/DOWN buttons, then RIGHT or ENTER button.
- 3 Select **Language Setup** using UP/DOWN buttons, then press the RIGHT or ENTER button.
- 4 Select **Audio** using UP/DOWN buttons, then press the RIGHT or ENTER button.
- 5 Press the UP/DOWN buttons to select '**English**'.
 - Select "Original" if you want the default soundtrack language to be the original language the disc is recorded in.
 - Select "Others" if the language you want is not listed.
- 6 Press the ENTER button.
 - English is selected and the screen returns to SETUP menu.



Using the Subtitle Language

- 1 With the unit in Stop mode, press the MENU button.
- 2 Select **Setup** using UP/DOWN buttons, then RIGHT or ENTER button.
- 3 Select **Language Setup** using UP/DOWN buttons, then press the RIGHT or ENTER button.
- 4 Select **Subtitle** using UP/DOWN buttons, then press the RIGHT or ENTER button.
- 5 Use the UP/DOWN buttons to select '**English**'.
 - Select "Automatic" if you want the subtitle language to be the same as the language selected as the audio preference.
 - Select "Others" if the language you want is not listed. Some discs may not contain the language you select as your initial language; in that case the disc will use its original language setting.
- 6 Press the ENTER button.
 - English is selected and the screen returns to SETUP menu.



NOTE

- If the selected language is not recorded on the disc, the original pre-recorded language is selected.
- **How to make the SETUP menu disappear or return to menu screen during set up:** Press RETURN or LEFT button.

CHANGING
SETUP MENU

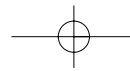

Setting Up the Audio Options

- 1 With the unit in Stop mode, press the MENU button.
- 2 Select **Setup** using UP/DOWN buttons, then RIGHT or ENTER button.
- 3 Select **Audio Setup** using UP/DOWN buttons, then press the RIGHT or ENTER button.
- 4 Use the UP/DOWN buttons to select the desired item. Then press the RIGHT or ENTER button.

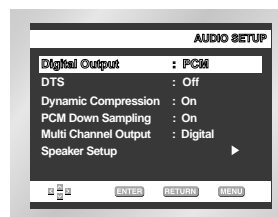

1 Digital Output

1. PCM :

Converts to PCM(2CH) audio.
Select PCM when using the Analog Audio Outputs.

2. Bitstream :

Converts to Dolby Digital Bitstream (5.1CH).
Select Bitstream when using the Digital Audio Output.

NOTE

- Be sure to select the correct Digital Output or no audio will be heard.
- When Multi Channel Output select Digital. Dolby & MPEG-2 Digital Out works.

2 DTS

1. Off : Doesn't output digital signal.
2. On : Outputs DTS Bitstream via digital output only.
Select DTS when connecting to a DTS Decoder.

3 Dynamic Compression

1. On : To select dynamic compression.
2. Off : To select the standard range.

4 PCM Down Sampling

1. On : Select this when the amplifier connected to the player is not 96KHz compatible.
In this case, the 96KHz signals will be down converted to 48KHz.
2. Off : Select this when the amplifier connected to the player is 96KHz compatible.
In this case, all signals will be output without any changes.

5 Multi Channel Output (DVD-P538K only)

1. Digital : Select this when using the multichannel digital audio output.
2. Analog : Select this when using the multichannel analog audio output.

6 Speaker Setup (DVD-P538K only)

NOTE

- **How to make the SETUP menu disappear or return to menu screen during set up;**
Press RETURN or LEFT button.
- Manufactured under license from Dolby Laboratories.
"Dolby" and the double-D symbol are trademarks of Dolby Laboratories.
- "DTS" and "DTS Digital Out" are trademarks of Digital Theater Systems, Inc.

Surround Sound Speaker Setup (DVD-P538K only)

- 1 With the unit in Stop mode, press the MENU button.
- 2 Select **Setup** using UP/DOWN buttons, then RIGHT or ENTER button.
- 3 Select **Audio Setup** using UP/DOWN buttons, then press the RIGHT or ENTER button.
- 4 Select **Multi Channel Output** using UP/DOWN buttons. Then select **Analog** pressing the RIGHT or ENTER button.
- 5 Use the UP/DOWN buttons to select **Speaker Setup**. Then press the RIGHT or ENTER button.
- 6 Use the UP/DOWN or LEFT/RIGHT buttons to select the desired item. Then press the ENTER button.

The default settings : FRONT L , R (Large), CENTER(None), SURROUND (None)

Select the size of the speakers to be connected.

• Front (FL , FR)

- **Large:** Normally select this.
- **Small:** When the sound cracks or the surround sound effects are difficult to hear, select this. This activates the Dolby Digital bass redirection circuitry and outputs the bass frequencies of the speaker from the subwoofer.

• Center

- **None:** If you do not connect a center speaker, select this.
- **Large:** Normally select this.
- **Small:** When the sound cracks, select this. This activates the Dolby Digital bass redirection circuitry and outputs the bass frequencies of the center speaker from other speakers.

• Surround (SL, SR)

- **None:** If you do not connect a center speaker, select this.
- **Large (Rear/Side):** Normally select either of these according to the rear speaker's position.
- **Small (Rear/Side):** When the sound cracks or the surround sound effects are difficult to hear, select either of these according to the rear speaker's position. This activates the Dolby Digital bass redirection circuitry and outputs the bass frequencies of the rear speaker from other speakers.

Setting up TEST

The test output signals come clockwise starting from the Front Speaker(L). Adjust Channel Balance to match to the volume of test signals memorized in the system.

FRONT(L) → CENTER → SUBWOOFER → FRONT(R)
→ SURROUND(R) → SURROUND(L)

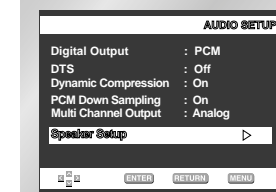
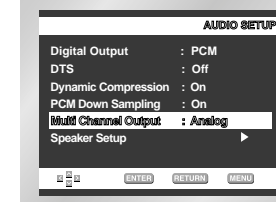

NOTE

- **How to make the SETUP menu disappear or return to menu screen during set up.**
Press RETURN or LEFT button.
- The subwoofer test output signal is lower than the other speakers.
- The MPEG Multichannel logo is a trademark registered by PHILIPS Corporation.

Setting Up the Display Options

- 1 With the unit in Stop mode, press the MENU button.
- 2 Select **Setup** using UP/DOWN buttons, then RIGHT or ENTER button.
- 3 Select **Display Setup** using UP/DOWN buttons, then press the RIGHT or ENTER button.
- 4 Use the UP/DOWN buttons to select the desired item. Then press the RIGHT or ENTER button.

- 1 TV Aspect
- 2 Still Mode
- 3 Screen Messages
- 4 Front Display
- 5 Black Level

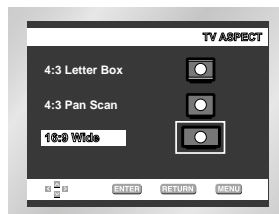
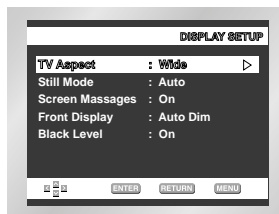
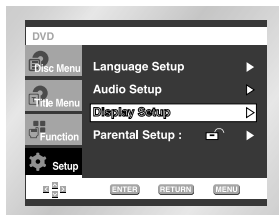

NOTE

- How to make the **SETUP** menu disappear or return to menu screen during set up; Press the RETURN or LEFT button.

Setting Up the Display Options

1 TV Aspect

Depending on the type of television you have, you may want to adjust the screen setting (aspect ratio).

1. 4:3 Letter Box :
Select when you want to see the total 16:9 ratio screen DVD supplies, even though you have a TV with a 4:3 ratio screen.
Black bars will appear at the top and bottom of the screen.
2. 4:3 Pan Scan :
Select this for conventional size TVs when you want to see the central portion of the 16:9 screen. (Extreme left and right side of movie picture will be cut off.)
3. 16:9 Wide :
You can view the full 16:9 picture on your widescreen TV.

2 Still Mode

These options will help prevent picture shake in still mode and display small text clearer.

1. Auto : When selecting Auto, Field/Frame mode will be automatically converted.
2. Field : Select this feature when the screen shakes in the Auto mode.
3. Frame : Select this feature when you want to see small letters more clearly in the Auto mode.

3 Screen Messages

Use to turn on-screen messages On or Off.

4 Front Display

Adjust the brightness of the unit's front panel display.

1. Auto Dim : Makes the Front Panel Display dim automatically when playing a DVD.
2. Bright : Makes the Front Panel Display bright.
3. Dim : Makes the Front Panel Display dim.

5 Black Level

Adjusts the brightness of the screen.(On/Off)

Setting Up the Parental Control

The Parental Control function works in conjunction with DVDs that have been assigned a rating - which helps you control the types of DVDs that your family watches. There are up to 8 rating levels on a disc.

- 1 With the unit in Stop mode, press the MENU button.
- 2 Select **Setup** using UP/DOWN buttons, then RIGHT or ENTER button.
- 3 Select **Parental Setup** using UP/DOWN buttons, then press the RIGHT or ENTER button.
- 4 Use RIGHT or ENTER to select **Yes** if you want to use a password. The **Enter Password** screen appears.
- 5 Enter your password. The Re-enter Password screen appears to confirm the password. Enter your password again. The Parental Control screen appears.

About the Rating Level ;

The Rating Level will work only when **Use Password** is set to Yes. To unlock the player, use UP/DOWN to select No. Use RIGHT or ENTER to select **Rating Level**. Press ENTER.

- Use UP/DOWN to select the level(e.g. Level 6) and press ENTER. Discs that contain Level 7 will now not play.
- To cancel the rating level, use RIGHT or ENTER to select No in Use Password.

About the Change Password ;

- Use UP/DOWN to select Change Password. Press ENTER. The Change Password screen appears.
- Enter your new password. Re-enter the new password again.

NOTE

- **How to make the SETUP menu disappear or return to menu screen during set up;** Press RETURN or LEFT button.
- If you have forgotten your password, see Forget Password in the Troubleshooting Guide.

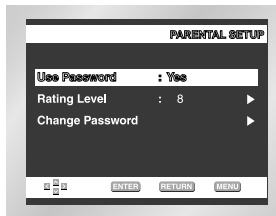
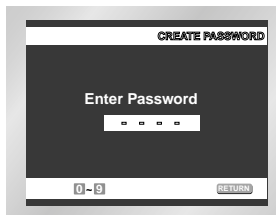
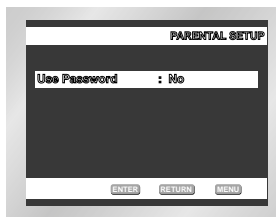

e.g) Setting up in LEVEL6.

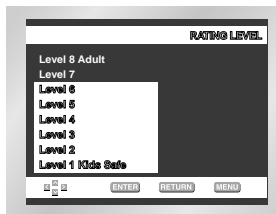

Controlling a TV with the Remote (DVD-P538K only)

The remote can also be set up to control most TVs. To program the remote, use the code that corresponds to your brand.

TV Codes

Code	Brand	Code	Brand
01	SAMSUNG_1	16	SHARP_1
02	SHARP_2	17	ZENITH
03	SONY	18	LG_3
04	MAGNAVOX	19	DAEWOO_8
05	SANYO_1	20	SANYO_2
06	LG_2	21	EMERSON
07	RCA	22	SHARP_3
08	LG_1	23	SAMSUNG_4
09	TOSHIBA	24	PANASONIC_2
10	HITACHI	25	NOBLEX
11	JVC	26	TELEFUNKEN
12	PANASONIC_1	27	NEWSAN
13	MITSUBISHI_2	28	LOEWE
14	SAMSUNG_2	29	RCA2
15	SAMSUNG_3		

- 1 Turn on the TV.
- 2 Point the DVD's remote at the TV.
- 3 While holding the TV POWER button down, enter the code for your brand.
- 4 If the TV turns off, setup is complete. Enter other codes of the same brand if the first code does not work.
- 5 To operate the TV, use the "TV Function Buttons" described on page 19.

e.g) For SAMSUNG_1 TVs

While holding down the TV POWER button, enter 0 and then 1.

NOTE

The remote may not be able to control every model TV of the brands listed.

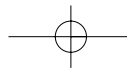

Troubleshooting

Before requesting service (troubleshooting), please check the following.

Problem	Action	Page
No operations can be performed with remote.	<ul style="list-style-type: none"> Check the batteries in the remote. May need replacing. Operate the remote control at a distance of no more than 20 feet. Remove batteries and hold down one or more buttons for several minutes to drain the microprocessor inside the remote to reset it. Reinstall batteries and try remote again. 	P4
Disc does not play.	<ul style="list-style-type: none"> Ensure that the disc is installed with the label side facing up. Check the region number of the DVD. 	P7
5.1 channel sound is not being reproduced.	<ul style="list-style-type: none"> 5.1 channel sound is reproduced only when the following conditions are met. : <ol style="list-style-type: none"> The DVD player is connected with the proper amplifier The disc is recorded with 5.1 channel sound. Check whether the disc being played has the "Dolby 5.1 ch" mark on the outside. Check if your audio system is connected and working properly. In a SETUP Menu, is the Audio Output set to Bitstream? 	P20 P50-51
The icon appears on screen.	<ul style="list-style-type: none"> The features or action cannot be completed at this time because: <ol style="list-style-type: none"> The DVD's software restricts it. The DVD's software doesn't support the feature (e.g., angles). The feature is not available at the moment. You've requested a title or chapter number or search time that is out of range. 	P24
Disc Menu doesn't appear.	<ul style="list-style-type: none"> Check if the disc has a Menu. 	P47-48
Play mode differs from the Setup Menu selection.	<ul style="list-style-type: none"> Some of the functions selected in the Setup Menu may not work properly if the disc is not encoded with the corresponding function. 	P47-54
The screen ratio cannot be changed.	<ul style="list-style-type: none"> The Screen Ratio is fixed on your DVDs. 	P52-53
No audio.	<ul style="list-style-type: none"> Make sure you have selected the correct Digital Output in the Audio Options Menu. 	P50-51
Forgot password	<ul style="list-style-type: none"> Press power on from a cold start with no disc in the unit. Press the STOP (■) and PLAY (▶/) buttons simultaneously on the front panel for three seconds. The Select Menu Language display will appear. Select the desired language button. Press the MENU button on the remote control to select the Parental Mode. The Parental Mode is now unlocked as indicated on the display. Press the DOWN button to select Parental. Press ENTER and the Create Password display will appear. You can now set your rating level and change your password to a new number. 	P54
If you experience other problems.	<ul style="list-style-type: none"> Go to the contents and find the section of the instruction book that contains the explanations regarding the current problem, and follow the procedure once again. If the problem still cannot be solved, please contact your nearest authorized service center. 	

Specifications

General	Power Requirements	AC 110~240V, 50/60 Hz
	Power Consumption	12 W
	Weight	2.4 Kg
	Dimensions	430mm (W) X 240mm (D) X 60mm (H)
	Operating Temperature Range	+5°C to +35°C
	Operating Humidity Range	10 % to 75 %
Disc	DVD (DIGITAL VERSATILE DISC)	Reading Speed : 3.49 m/sec. Approx. Play Time (Single Sided, Single Layer Disc) : 135 min.
	CD : 12Cm (COMPACT DISC)	Reading Speed : 1.2 to 1.4 m/sec. Maximum Play Time : 74 min.
	CD : 8Cm (COMPACT DISC)	Reading Speed : 1.2 to 1.4 m/sec. Maximum Play Time : 20 min.
	VCD : 12Cm	Reading Speed : 1.2 to 1.4 m/sec. Maximum Play Time : 74 min. (Video + Audio)
Video Output	Composite Video	1 channel : 1.0 Vp-p (75 Ω load)
	Component Video	Y : 1.0 Vp-p (75 Ω load) Pr : 0.70 Vp-p (75 Ω load) Pb : 0.70 Vp-p (75 Ω load)
	S-VIDEO	Luminance Signal : 1.0 Vp-p (75 Ω load) Chrominance Signal : 0.286 Vp-p (75 Ω load)
Audio Output	2 channel	L(1/L), R(2/R)
	*Frequency Response	48 kHz Sampling : 4 Hz to 22 kHz 96 kHz Sampling : 4 Hz to 44 kHz
	*S/N Ratio	110 dB (DVD-E138A/DVD-1010/DVD-E138B/DVD-E238) 105 dB (Karaoke off Mode DVD-E338K/DVD-P538K)
	*Dynamic Range	100 dB (DVD-E138A/DVD-1010/DVD-E138B/DVD-E238) 96 dB (Karaoke off Mode DVD-E338K/DVD-P538K)
	*Total Harmonic Distortion	0.004 % (DVD-E138A/DVD-1010/DVD-E138B/DVD-E238) 0.004 % (Karaoke off Mode DVD-E338K/DVD-P538K)

*: Nominal specification

- Samsung Electronics Co., Ltd reserves the right to change the specifications without notice.
- Weight and dimensions are approximate.