

OLYMPUS[®]

Electronic Flash

DIGITAL
FL-36

EN Instructions



2

Thank you for purchasing the OLYMPUS Electronic Flash (FL-36). Before use, please read this instruction manual to ensure your safety, and keep it handy for future reference.

SAFETY PRECAUTIONS (Be sure to read and observe the following.)

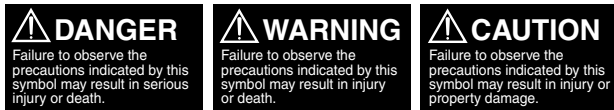
This instruction manual uses a variety of common symbols and icons to assist you in proper handling and usage of this product properly, and to warn you of potential hazards to yourself and others as well as to property. These symbols and their significance are described below.



Symbols for prohibiting action	Symbol instructing action
 Prohibited	 Mandatory
 Disassembly prohibited	

For customers in Europe



The "CE" mark indicates that this product complies with the European requirements for safety, health, environment and customer protection. CE-mark products are for sale in Europe.

For customers in USA

FCC Notice

This device complies with part 15 of the FCC rules. Operation is subject to the following two conditions: (1) This device may not cause harmful interference, and (2) this device must accept any interference received, including interference that may cause undesired operation.



Any unauthorized changes or modifications to this equipment would void the user's authority to operate.

For customers in CANADA







This Class B digital apparatus complies with Canadian ICES-003.

- This electronic flash has been designed exclusively for use with Olympus digital cameras. Do not connect the electronic flash to a camera not manufactured by Olympus, as this may result in a malfunction or damage to the camera and/or flash.







DANGER

- The electronic flash incorporates high-voltage circuitry. Never attempt to disassemble or modify it, as this may result in electric shock and/or injury. 
- Do not use the electronic flash in a place where it may be exposed to flammable or explosive gas. Otherwise, fire ignition or explosion may result. 
- To prevent a traffic accident, do not direct the flash towards the driver of a car. 



WARNING

- Do not fire the flash or AF illuminator light immediately in front of a person's eyes (particularly an infant). Exposure to the light from the flash at a very short range may cause irreparable injury to the eyes. Be especially careful to avoid using the electronic flash at a distance of less than 1 meter from an infant. 
- Do not leave the electronic flash and batteries within reach of children.
 - If a child swallows a battery or small accessory, see a doctor immediately.
 - If the flash is emitted near a child, their eyes may be injured irreparably.
 - Moving parts of the electronic flash could injure a child.
- Avoid the following actions to prevent fire or injury due to battery fluid leak, overheating, fire ignition or bursting.
 - Do not use batteries that are not specified for use with this electronic flash.
 - Do not throw the battery in a fire, expose it to heat, short-circuit it, or disassemble it.
 - Do not mix old and new batteries, or batteries of different types or brands.
 - Do not attempt to recharge non-rechargeable batteries such as alkaline batteries.
 - Do not load batteries with the +/- polarity reversed.
- Do not store the electronic flash in a place exposed to excessive dust or moisture. Otherwise, fire or electric shock may result. 
- Do not use the flash when it is covered by a flammable object such as a handkerchief. Do not touch the light-emitting area after use. It will be very hot and could burn you. 
- If the electronic flash is dropped in water or any fluid gets inside, immediately remove the batteries and contact your dealer or Olympus. Continued use could result in fire or electric shock. 

⚠ CAUTION

- If you notice any abnormalities such as leakage, discoloration, deformation, overheating, or odor, stop using this device. Continued use could result in fire, overheating or explosion. Remove the batteries carefully to avoid burning yourself and to prevent exposure to gas or dangerous fluids that may be released. For repair, contact Olympus. 
- Always remove the batteries when you don't expect to use the electronic flash for a long period. Otherwise, heat generation or fluid leak from the batteries may result in fire, injury and/or contamination of the surroundings. 
- Do not use a leaking battery. Doing so could result in fire or electric shock. Please contact your dealer or Olympus. 
- Do not handle the electronic flash with wet hands. Doing so could result in electric shock. 
- Do not leave the electronic flash in a place where it may be exposed to high temperatures. Otherwise, deterioration of parts or fire may result. 
- Do not take out the batteries immediately after using the electronic flash continuously for a long period. Otherwise, the hot batteries may cause burns. 
- Do not deform the battery compartment or allow any foreign objects to get inside. 



HANDLING PRECAUTIONS

- The electronic flash is composed of precision electronic parts. Absolutely avoid using or storing the electronic flash in the following places, as this may result in malfunction or failure.
 - Under direct sunlight, on a beach, etc.
 - Anywhere exposed to high temperatures and humidity or rapid fluctuations in temperature and humidity.
 - Any place exposed to excessive sand, dust or dirt.
 - Near an air conditioner or air humidifier.
 - Any place subject to vibrations.
 - Near a fire.
 - Any place exposed to water or moisture.
 - Inside an automobile.
- Do not apply a strong vibration or shock to the electronic flash by dropping it or hitting it against something. 
- When the electronic flash has not been used for a long period, mold or moss may form. This can cause a malfunction. To prevent this, it is recommended to check the operations before using the electronic flash after a long period of storage. 

- Do not touch the electric contacts of the electronic flash to prevent malfunction. 

- To prevent overheating and deterioration of the light-emitting section, do not continue full activation more than 10 times in a row. After 10 successive operations, stop firing for a while until the light-emitting section cools down. 

BATTERY PRECAUTIONS

- Use only the specified batteries. (see page 14) 
- Be sure to observe the following points. Otherwise, battery fluid leak, overheating, fire ignition and/or bursting may result.
 - Do not mix old and new batteries, recharged and discharged batteries, batteries of different capacities, or batteries of different types or brands.
 - Do not attempt to recharge non-rechargeable batteries such as alkaline batteries.
 - Do not load or use the batteries with the +/- polarity reversed. If the batteries do not fit smoothly in the battery compartment, do not force them.
 - Never use a battery if its outer coating (insulation) has been partially or entirely peeled off. Otherwise, leakage, overheating or explosion may result.
 - Some brand-new batteries may also have their outer coating (insulation) peeled off completely or partially. Never use these batteries.

- Do not use the following kinds of batteries.

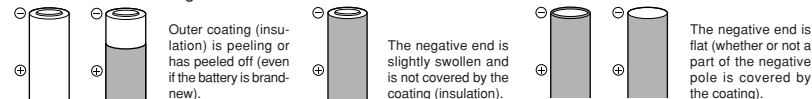

- All rechargeable batteries must be recharged using the specified battery charger, simultaneously and completely. Be sure to read the battery and battery charger instruction manual. 

■ Improper use of batteries may result in fluid leak, heat generation and/or damage. Sweat and oil smudges may cause battery contact failure. To prevent this, remove any stain completely with a dry cloth and insert the batteries by observing the +/– polarity.



■ In general, battery performance will be temporarily reduced as the ambient temperature drops. When using batteries in a cold place, keep them warm by keeping the electronic flash in cold protection gear or clothing.



■ If battery fluid gets on your skin or clothes, it may irritate your skin. Immediately rinse your skin or clothes with clean water.



■ If battery fluid comes in contact with your eyes, blindness may result. Rinse your eyes with clean water without rubbing them and see a doctor immediately.



■ Do not apply a strong shock to a battery or throw it.



■ When traveling, it is a good idea to carry spare batteries with you. In some countries, it may be difficult to obtain certain batteries.



■ Do not immerse batteries in water or expose to moisture including rain, seawater and animal urine.



■ If the +/– terminals of a battery are stained with sweat or oil smudges, contact failure may result. Clean the terminals well with a dry cloth before using the batteries.



■ Do not throw a battery in fire or heat it.



■ When disposing of batteries, be sure to follow local regulations.



■ When disposing of a rechargeable battery, insulate the +/– terminals with pieces of tape and take them to your nearest rechargeable battery recycling center.



Note on the cameras used with the Electronic Flash

- The functions available from the electronic flash are limited with certain digital cameras. For details, please check the Olympus website (<http://www.olympusamerica.com/E1>).

Before reading this manual

- The information in this manual may be subject to change without notice.
- This manual has been compiled as carefully as possible. However, if you have any questions or wish to report an error or omission, please contact Olympus.
- Duplication of this manual in part or in whole without permission of Olympus is prohibited except for personal use. Reproduction of the contents of this manual without permission of Olympus is strictly prohibited.
- Olympus will not assume any liability for the damages, loss of profit or claims from any third party incurred due to improper use of this product.
- Olympus will not assume any liability for the damages and loss of profit related to the loss of image data due to a failure of this product, servicing by a third party not designated by Olympus or any other reason.
- Note that the quality of the pictures shot using this product differs from that of the pictures of ordinary film-based cameras.

Trademark information

All brand names and product names mentioned in this manual are the trademarks or registered trademarks of their respective owners.

CONTENTS

- Checking the Package Contents 9
- Nomenclature 10
- Control Panel Indicators 12
- Loading Batteries 14
- Checking Batteries 16
- Attaching to the Camera/Removing from the Camera 18
- Picture Shooting Using a Digital Camera with Communication Capability 20
 - Selecting the control mode 20
 - TTL AUTO 22
 - AUTO 24
 - MANUAL 27
 - FP TTL AUTO 29
 - FP MANUAL 32
- Picture Shooting Using a Digital Camera without Communication Capability 34
- Selecting the control mode 34
- AUTO 35
- MANUAL 37
- Other Operations 39
 - Bounce Shooting 39
 - Close-up Flash 41
 - Manual Switching of Firing angle (ZOOM) 42
 - Using the Wide Panel 43
 - Various Flash Shooting Methods 45
- Custom Setup 47
- All Reset 50
- Continuous Firing 51
- Guide Number (GN) List 52
- Warning Display List 55
- Q&A 58
- Main Specifications 61

CHECKING THE PACKAGE CONTENTS

Check that all parts and accessories are present.
If any item is missing or damaged, contact your dealer.

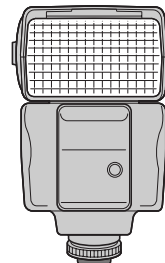

• Electronic flash, main body

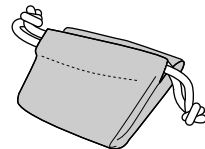

• Flash case

• Batteries must be purchased separately.

NOMENCLATURE

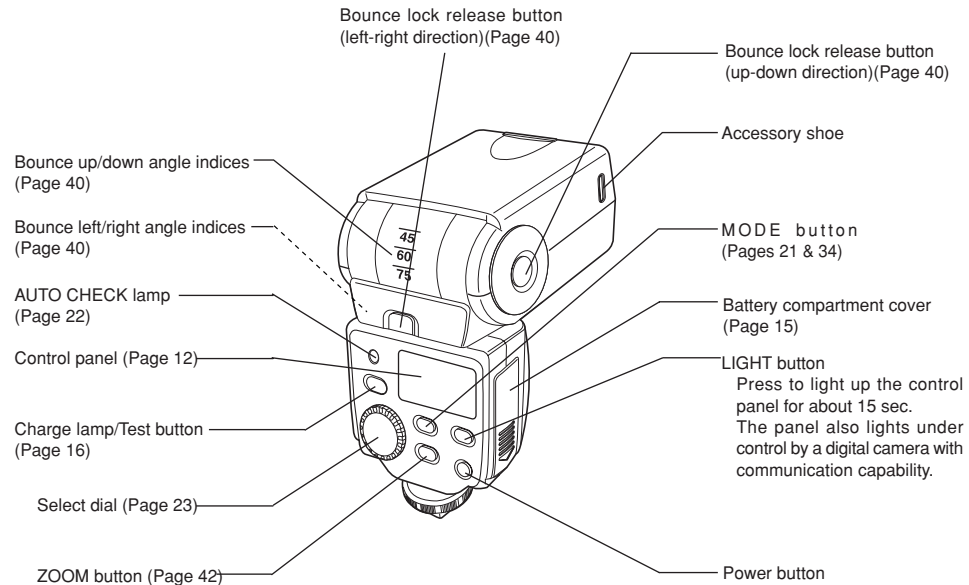
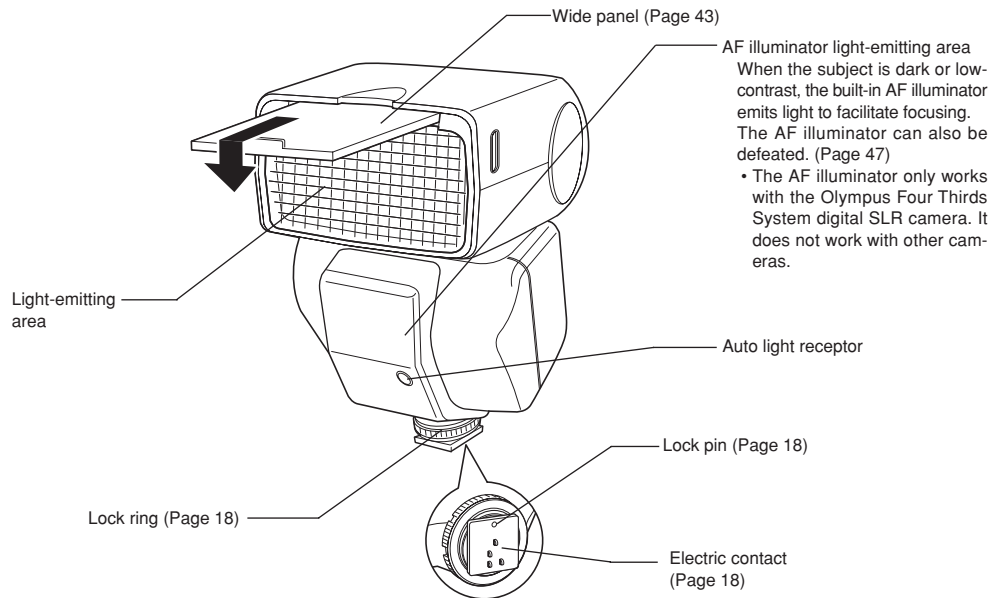

CONTROL PANEL INDICATORS

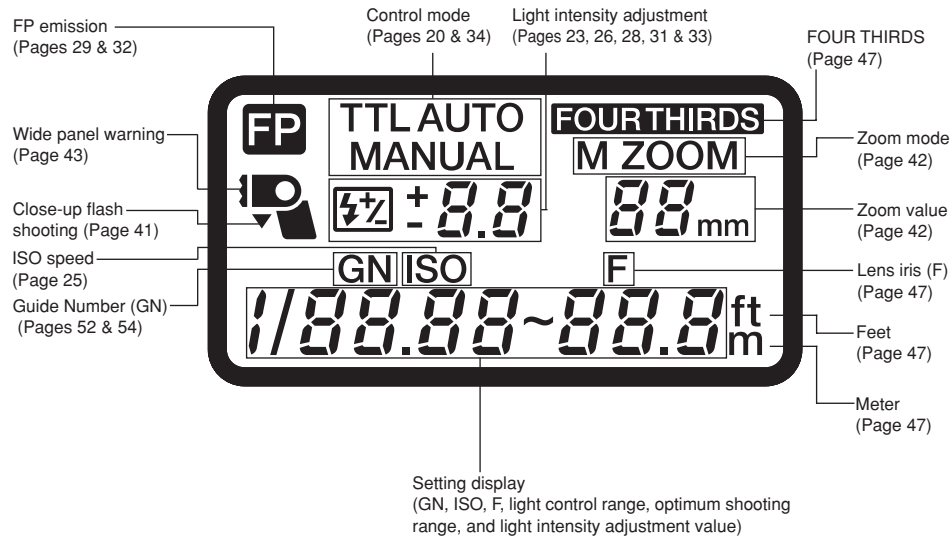

• To simplify explanation, this figure shows the panel with all indicators lit.

Notes on This Manual

• The indications on the control panel may differ from those shown in the illustration above depending on the setup of the electronic flash, the camera in use, and the shooting conditions.

For example, the firing angle (ZOOM) can be displayed in either of the following modes.

- ① FOUR THIRDS : Focal length of a Four Thirds System digital camera
- ② 135 : Focal length converted to an equivalent angle of view on a 135 type (35 mm film) camera

The text in this manual employs the FOUR THIRDS display mode and puts value in the 135 display mode inside parentheses, such as "(XX mm with 135)". For the selection of the display modes, see page 47 .

LOADING BATTERIES

The batteries are available separately. Always use one of the following battery combinations.

- AA (R6) alkaline batteries (LR6 type) x 2
- AA (R6) Ni-Cd batteries x 2
- AA (R6) Ni-Mh batteries x 2
- AA (R6) Ni-Mn batteries (ZR6 type) x 2
- AA (R6) lithium batteries (FR6 type) x 2
- AA (R6) oxyride batteries (ZR6Y type) x 2
- Lithium battery pack (CR-V3 type) (Olympus LB-01) x 1
 - The AA (R6) manganese batteries cannot be used.

Recommended Batteries

The flash's charging circuitry is optimized for use with the following batteries:

- AA (R6) Ni-Mh battery
- Lithium battery pack (CR-V3 type) (Olympus LB-01)

How to load the batteries

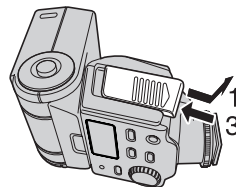

1. Open the battery compartment cover.

2. Insert the batteries with correct +/- polarity.

3. Close the battery compartment cover.

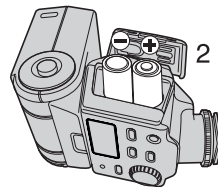

AA (R6) batteries

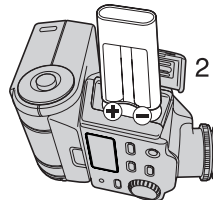

CR-V3

Notes

- Do not mix old and new batteries or batteries of different types together.
- Remove the batteries when the electronic flash is not going to be used for a long period.
- Carry spare batteries when traveling or when using the flash in cold areas.

CHECKING BATTERIES

After loading the batteries, check the remaining battery capacity by turning the electronic flash on.

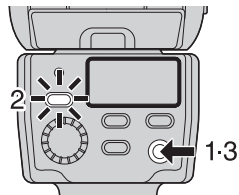

1. Press the Power button to turn the electronic flash on.
 - The control panel lights up and battery charging starts.
2. Ensure that the Charge lamp lights up.
 - Replace the batteries if the time taken for the Charge lamp to light up is longer than the values specified below.
Alkaline or Ni-Mn batteries: 30 sec.
Lithium, Ni-Cd, Oxyride or Ni-Mh batteries: 10 sec.
 - If the Charge lamp and AUTO CHECK lamp blink alternately, it means that the battery capacity is running low. In this case, replace the batteries.

Memo: To perform test flash activation, press the Test button.

3. Press the Power button again to turn the electronic flash off.

Turn the electronic flash off in the following cases:
 - Before mounting it on the camera or dismounting it from the camera.
 - When flash emission is not required.
 - When not using the electronic flash.

Flash Interval and Flash Count

The following table shows the flash intervals and flash counts for various batteries. Data is based on using batteries all of the same type.

Batteries used	Flash interval	Flash count
AA (R6) alkaline dry cell batteries (LR6 type)	Approx. 7.5 sec.	Approx. 140 times
AA (R6) Ni-Cd batteries (P3SPS type, 1000 mAh)	Approx. 6.5 sec.	Approx. 100 times
AA (R6) Ni-Mh batteries (HHR-3SPS type, 2230 mAh)	Approx. 5.5 sec.	Approx. 200 times
AA (R6) Oxyride batteries (ZR6Y type)	Approx. 6.5 sec.	Approx. 140 times
AA (R6) lithium batteries (FR6 type)	Approx. 7.5 sec.	Approx. 260 times
CR-V3 lithium battery packs (Olympus LB-01)	Approx. 6.5 sec.	Approx. 320 times

- The flash emission interval and count data were obtained from in-house tests at Olympus.

ATTACHING TO THE CAMERA/REMOVING FROM THE CAMERA

Confirm that both the camera and electronic flash are off.

Attaching or removing the electronic flash while either the flash or the camera is on may result in malfunction.

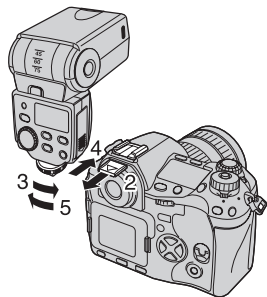
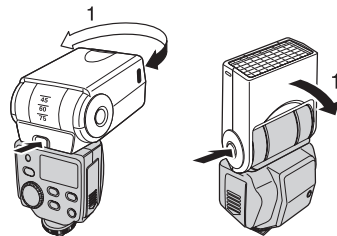

How to attach

1. Place the light-emitting section in the standard position (horizontal, front). If it is in the locked position, press and turn the Bounce lock release button.
2. Remove the hot shoe cover from the camera.
 - Store the hot shoe cover in the pocket located on the inner side of the flash case.
3. Loosen the lock ring.
 - If the lock pin is in the out position, press it in by turning it all the way in the opposite direction to [←LOCK] until it stops.



- Do not apply excessive force to the lock pin.
 - Do not touch the electric contact with a finger or metallic object.
 - Do not attach the electronic flash while the lock pin is in the out position. Otherwise, malfunction may result.
4. Slide the electronic flash all the way into the hot shoe until it stops with a click.
 5. Turn the lock ring all the way into the direction of [←LOCK] until it stops.

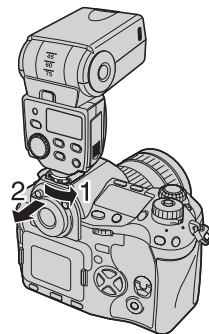

How to remove

1. Loosen the lock ring completely, then slide the electronic flash out of the hot shoe.
2. Attach the hot shoe cover to the camera.

Notes

To use the electronic flash with a digital camera not equipped with hot shoe:

- If the camera has an external flash terminal, the electronic flash can be attached and connected using the flash bracket and bracket cable (optional).
- The electronic flash cannot be used with a camera that is not equipped with a hot shoe or external flash terminal.

PICTURE SHOOTING USING A DIGITAL CAMERA WITH COMMUNICATION CAPABILITY

<Selecting the control mode>

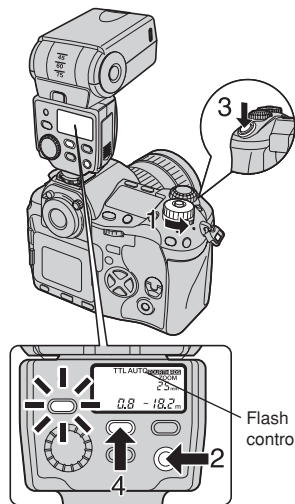

1. Turn the camera on.
2. Turn the electronic flash on. The batteries are recharged when the Charge lamp lights up.
3. Press the Shutter button of the camera gently to start communication of shooting information including ISO speed, lens iris and shutter speed between the camera and electronic flash.
4. Press the MODE button of the electronic flash to select the flash control mode.
 - The selected flash control mode is shown in the control panel.
 - The mode is switched every time the MODE button is pressed.

Flash control mode	Control panel display	Control operation	Main application	Ref. Pages
TTL AUTO	TTL AUTO	Flash is controlled automatically by performing pre-flash according to the camera setup.	Usually use this mode with a camera with communication capability.	22
AUTO	AUTO	Flash light intensity is controlled according to the light detected through the auto light receptor of the flash and to the camera setup.	If the camera has communication capability, this mode can be used only when the camera is an AUTO-compatible model.	24
MANUAL	MANUAL	Flash is performed according to the manually set guide number (GN).	Shooting using manual flash.	27
FP TTL AUTO	FP TTL AUTO	TTL AUTO and MANUAL modes with Super FP emission that can synchronize with the high-speed shooting of the single-lens-reflex focal plane shutter.	Outdoor shooting using flash, such as sync shooting in the daytime.	29 & 32
FP MANUAL	FP MANUAL			

■ Notes

- Certain modes may be unavailable depending on the shooting mode set on the camera and the functions of the camera in use.
- It is not possible to select an unavailable mode.

<TTL AUTO>

In this mode, pre-flash is performed to measure the optimum flash intensity and then actual flash is performed.

TTL AUTO indicator ZOOM indicator
Displayed according to the
focal length of the lens.

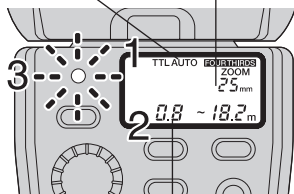

Light control range

1. The control panel shows the light control range according to the camera setup.
2. Confirm that the distance to the subject is within the light control range.
If not, adjust the lens iris (F) or the subject distance.
The light control range varies according to the camera type and camera setup (ISO speed, lens iris (F) and lens focal distance (ZOOM)).
3. When flash activation has been performed correctly, the AUTO CHECK lamp blinks for about 5 seconds after the shutter is released.

■ Light intensity adjustment

The flash light intensity can be adjusted between +3 and -3.

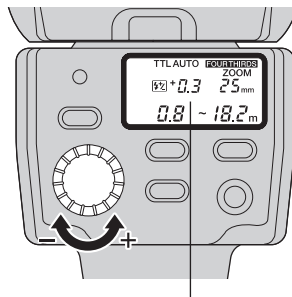

Light intensity adjustment value

The light intensity adjustment must be set to ON in the custom setup operation (page 47).

• The  indicator appears in the control panel.

1. Turn the select dial to choose a light intensity adjustment value.
0 → +0.3 → +0.7 → +1.0 ... +3.0
0 → -0.3 → -0.7 → -1.0 ... -3.0
2. The display shows the light intensity adjustment value except when the value is 0. In this case, the displayed light control range corresponds to an adjustment value of 0.
3. If the camera's flash adjustment mode is selected, the actual flash light intensity will be the total of the light intensity adjustment value set on the FL-36 and that set on the camera. The light intensity adjustment value displayed is that of the FL-36 only.

[Example]

	Selected adjustment value	Adjustment value displayed on FL-36	Actual light intensity adjustment
FL-36	+0.3	+0.3	+0.6
Camera	+0.3		

<AUTO>

In this mode, the flash light intensity is controlled automatically according to the lens iris (F) setting and the amount of light input to the auto light receptor.

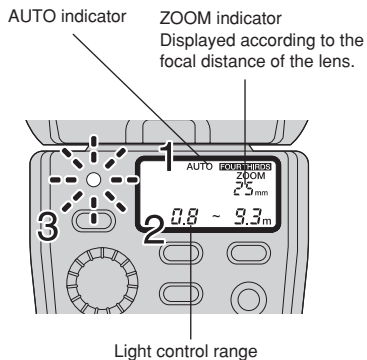

- The control panel shows the light control range according to the camera setup.
The light control range is not displayed if the camera setup (ISO speed and lens iris (F)) does not match one of the usable ISO speed/lens iris (F) combinations.
In this case, the ISO and F indicators blink to alert you.
Change the camera setup (ISO speed and/or lens iris (F)).
(See page 55.)
- Confirm that the distance to the subject is within the light control range.
If not, adjust the lens iris (F) or the subject distance.
The light control range varies according to the camera setup (ISO speed, lens iris (F) and lens focal length (ZOOM)).

Combinations of ISO speeds and lens irises controllable in AUTO mode

	ISO speed							
	3200	1600	800	400	200	100	50	25
Lens iris	F8	F5.6	F4	F2.8	F2	F1.4		
	F11	F8	F5.6	F4	F2.8	F2	F1.4	
	F16	F11	F8	F5.6	F4	F2.8	F2	F1.4
	F22	F16	F11	F8	F5.6	F4	F2.8	F2
	F32	F22	F16	F11	F8	F5.6	F4	F2.8
		F32	F22	F16	F11	F8	F5.6	F4
			F32	F22	F16	F11	F8	F5.6
				F32	F22	F16	F11	F8

- When flash activation has been performed correctly, the AUTO CHECK lamp blinks for about 5 seconds after the shutter is released.

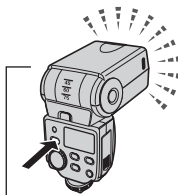

Memo: Test flash activation

Flash activation can be tested before actually releasing the shutter.
Press the Test button for test flash activation.
The light control is OK when the AUTO CHECK lamp blinks for about 5 seconds after the test flash activation.
If the lamp does not blink, change the lens iris (F), ISO speed, subject distance, etc.
• The light check by means of test flash activation is possible only in the AUTO mode.

Light intensity adjustment

The flash light intensity can be adjusted between +3 and -3.

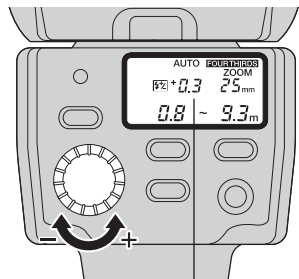

Light intensity adjustment value

The light intensity adjustment must be set to ON in the custom setup operation (page 47).

- The indicator appears in the control panel.

- Turn the select dial to choose a light intensity adjustment value.
0 → +0.3 → +0.7 → +1.0 ... +3.0
0 → -0.3 → -0.7 → -1.0 ... -3.0
- The display shows the light intensity adjustment value except when the value is 0. In this case, the displayed light control range corresponds to an adjustment value of 0.
- If the camera's flash adjustment mode is selected, the actual flash light intensity will be the total of the light intensity adjustment value set on the FL-36 and that set on the camera. The light intensity adjustment value displayed is that of the FL-36 only.

[Example]

	Selected adjustment value	Adjustment value displayed on FL-36	Actual light intensity adjustment
FL-36	+0.3	+0.3	+0.6
Camera	+0.3		

<MANUAL>

In this mode, the flash is emitted according to the guide number (GN) setting.

MANUAL indicator ZOOM indicator
Displayed according to the focal distance of the lens.

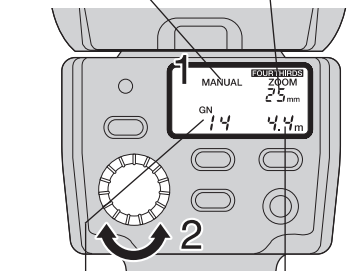

Guide number (GN)

Optimum shooting distance

- The control panel shows the current guide number (GN) together with the optimum shooting distance according to the camera setup.
- Turn the select dial to set the guide number (GN). Set the guide number (GN) so that the optimum shooting distance is equal to the subject distance. When the optimum shooting distance is 0.6 m (0.5 m in case of close-up flash) or less, the displayed figure blinks to warn that the subject is located outside the flash light emission area. Optimum shooting distance varies according to the camera settings (ISO speed, lens iris (F) and lens focal distance (ZOOM)). See page 52 for details.

Memo: Assuming that the ISO speed is 100, the optimum shooting distance can be calculated with the following formula.
Optimum shooting distance = Guide number (GN)/Lens iris (F)
(See page 54.)

Light intensity adjustment

The flash light intensity can be adjusted between +0.7 and -0.7.

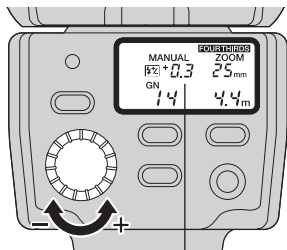

Light intensity adjustment value

The light intensity adjustment must be set to ON in the custom setup operation (page 47).

- The  indicator appears in the control panel.

1. Turn the select dial to choose a light intensity adjustment value.

0 → +0.3 → +0.7

0 → -0.3 → -0.7

2. The display shows the light intensity adjustment value except when the value is 0. In this case, the displayed guide number (GN) and optimum shooting distance correspond to an adjustment value of 0.

3. Even if the camera's flash adjustment mode is selected, only the FL-36's adjustment setting will work. The camera's setting will not work.

[Example]

	Selected adjustment value	Adjustment value displayed on FL-36	Actual light intensity adjustment
FL-36	+0.3	+0.3	+0.3
Camera	+0.3		

<FP TTL AUTO>

- In this mode, the flash uses Super FP emission to synchronize with high shutter speeds.
- For details on using the camera's built-in flash, see "Various Flash Shooting Methods" on page 45.

The following operations are possible at high shutter speeds in this mode.

- Attenuation of shades when shooting a picture against the light.
- Outdoor portrait shooting using daytime sync shooting with the lens iris opened up to blur the background.

Without flash



Shooting against light

With flash (FP TTL AUTO)



With lens iris adjusted



Portrait shooting

With lens iris open



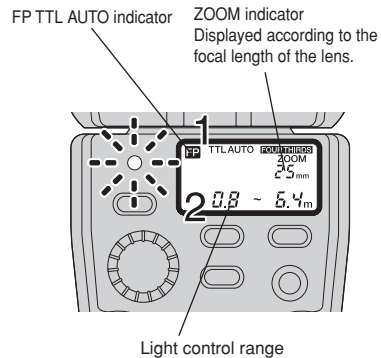



1. The control panel shows the light control range according to the camera setup.
If not, adjust the lens iris (F) or the subject distance.
The light control range varies according to the camera setup (ISO speed, lens iris (F) and lens focal distance (ZOOM)). The light control range is smaller than that in the TTL mode.
2. Confirm that the distance to the subject is within the light control range.
3. When flash activation has been performed correctly, the AUTO CHECK lamp blinks for about 5 seconds after the shutter is released.

Light intensity adjustment

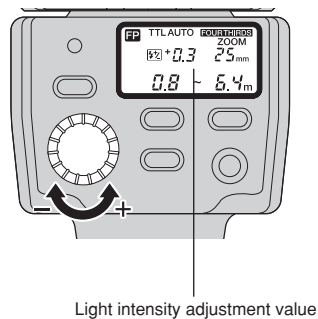
The flash light intensity can be adjusted between +3 and -3.



The light intensity adjustment must be set to ON in the custom setup operation (page 47).

- The  indicator appears in the control panel.

1. Turn the select dial to choose a light intensity adjustment value.
0 → +0.3 → +0.7 → +1.0 ... +3.0
0 → -0.3 → -0.7 → -1.0 ... -3.0
2. The display shows the light intensity adjustment value except when the value is 0. In this case, the displayed light control range corresponds to an adjustment value of 0.
3. If the camera's flash adjustment mode is selected, the actual flash light intensity will be the total of the light intensity adjustment value set on the FL-36 and that set on the camera. The light intensity adjustment value displayed is that of the FL-36 only.

[Example]

	Selected adjustment value	Adjustment value displayed on FL-36	Actual light intensity adjustment
FL-36	+0.3	+0.3	+0.6
Camera	+0.3		

<FP MANUAL>

In this mode, Super FP emission is performed at the set light intensity.

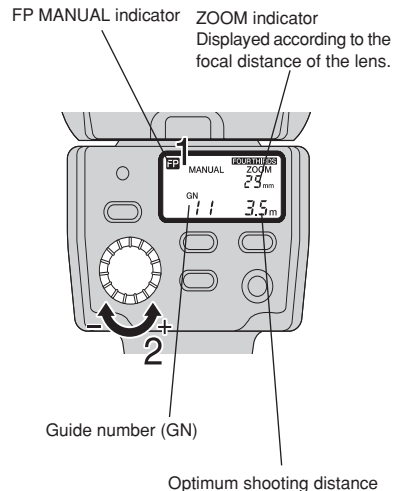

1. Turn the select dial to set the guide number (GN). Together with the optimum shooting distance according to the camera setup.

2. Turn dial A to set the guide number (GN).

Set the guide number (GN) so that the optimum shooting distance is equal to the subject distance.

When the optimum shooting distance is 0.6 m (0.5 m in case of close-up flash) or less, the displayed figure blinks to warn that the subject is located outside the flash light emission area. (see page 55.)

The optimum shooting distance varies according to the camera setup (ISO speed, lens iris (F), lens focal length (ZOOM) and shutter speed). See page 54 for details.

Memo: The optimum shooting distance can be calculated with the following formula.
Optimum shooting distance = Guide number (GN)/Lens iris (F)

Light intensity adjustment

The flash light intensity can be adjusted between +0.7 and -0.7.

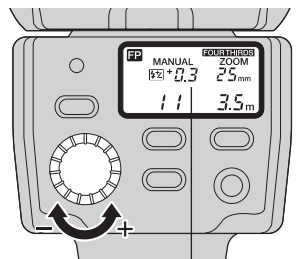

Light intensity adjustment value

The light intensity adjustment must be set to ON in the custom setup operation (page 47).

- The indicator appears in the control panel.

1. Turn the select dial to choose a light intensity adjustment value.

0 → +0.3 → +0.7

0 → -0.3 → -0.7

2. The display shows the light intensity adjustment value except when the value is 0. In this case, the displayed guide number (GN) and optimum shooting distance correspond to an adjustment value of 0.

3. Even if the camera's flash adjustment mode is selected, only the FL-36's adjustment setting will work. The camera's setting will not work.

[Example]

	Selected adjustment value	Adjustment value displayed on FL-36	Actual light intensity adjustment
FL-36	+0.3	+0.3	+0.3
Camera	+0.3		

<Selecting the control mode>

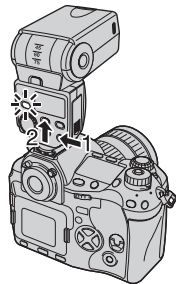

1. Turn the electronic flash on. The batteries are recharged when the Charge lamp lights up.
2. Press the MODE button to select the flash control mode.
 - The selected mode is shown in the control panel.
 - The mode is switched every time the MODE button is pressed.

Flash control mode	Control panel display	Control operation	Main application	Ref. Pages
	AUTO	Flash light intensity is controlled according to the light detected through the auto light receptor of the flash and to the lens iris (F).	Usually use this mode.	35
	MANUAL	Flash activation is performed according to the manually set guide number (GN).	Shooting using manual flash.	37

<AUTO>

In this mode, the flash light intensity is controlled automatically according to the lens iris (F) setting.

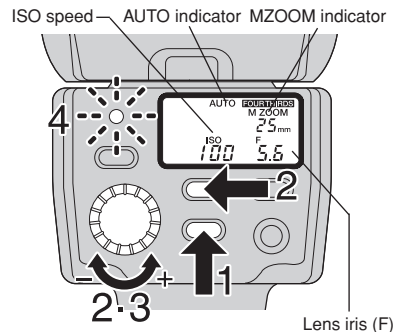

1. Adjust Zoom according to the focal length of the lens.
2. While keeping the MODE button pressed, turn the select dial within 2 seconds to set the ISO speed.
Note: If the MODE button is kept pressed for more than 2 seconds, the flash mode changes to the Custom Setup mode (see page 47).
3. Turn the select dial according to the lens iris (F).
If the camera setup (ISO speed and lens iris (F)) does not match one of the usable ISO speed/lens iris (F) combinations, the ISO and F indicators blink to alert you. In this case, change the camera setup (ISO speed and/or lens iris (F)).
4. When flash activation has been performed correctly, the AUTO CHECK lamp blinks for about 5 seconds after the shutter is released.

Memo: By selecting an ISO speed and lens iris (F) different from those set on the camera, the light intensity can be adjusted in 1/3 steps.

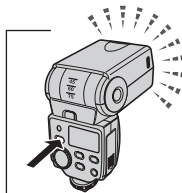

Memo: Test flash activation
Flash activation can be tested before actually releasing the shutter. Press the Test button for test flash activation. The light control is OK when the AUTO CHECK lamp blinks for about 5 seconds after the test flash activation. If the lamp does not blink, change the lens iris (F), ISO speed, subject distance, etc.
• The light check by means of test flash activation is possible only in the AUTO mode.

■ Light control range in AUTO mode

AUTO light control range (m)

Lens iris	ISO speed								Firing angle (mm) Upper row: FOUR THIRDS. Lower row: 135															
	3200		1600		800		400		200		100		50		25		8 (W panel)	10 (W panel)	12	14	17	25	35	42
	16 (W panel)		20 (W panel)		24		28		35		50		70		85									
	F8	F5.6	F4	F2.8	F2	F1.4			0.8 - 8.6	0.9 - 10.0	1.3 - 14.3	1.4 - 15.7	1.5 - 17.1	1.8 - 20.0	2.0 - 22.9	2.3 - 25.7								
	F11	F8	F5.6	F4	F2.8	F2	F1.4		0.6 - 6.0	0.6 - 7.0	0.9 - 10.0	1.0 - 11.0	1.1 - 12.0	1.3 - 14.0	1.4 - 16.0	1.6 - 18.0								
	F16	F11	F8	F5.6	F4	F2.8	F2	F1.4	0.5 - 4.3	0.5 - 5.0	0.6 - 7.1	0.7 - 7.9	0.8 - 8.6	0.9 - 10.0	1.0 - 11.4	1.1 - 12.9								
	F22	F16	F11	F8	F5.6	F4	F2.8	F2	0.5 - 3.0	0.5 - 3.5	0.5 - 5.0	0.5 - 5.5	0.5 - 6.0	0.6 - 7.0	0.7 - 8.0	0.8 - 9.0								
	F32	F22	F16	F11	F8	F5.6	F4	F2.8	0.5 - 2.1	0.5 - 2.5	0.5 - 3.6	0.5 - 3.9	0.5 - 4.3	0.5 - 5.0	0.5 - 5.7	0.6 - 6.4								
		F32	F22	F16	F11	F8	F5.6	F4	0.5 - 1.5	0.5 - 1.8	0.5 - 2.5	0.5 - 2.8	0.5 - 3.0	0.5 - 3.5	0.5 - 4.0	0.5 - 4.5								
			F32	F22	F16	F11	F8	F5.6	0.5 - 1.1	0.5 - 1.3	0.5 - 1.8	0.5 - 2.0	0.5 - 2.2	0.5 - 2.5	0.5 - 2.9	0.5 - 3.3								
				F32	F22	F16	F11	F8	0.5 - 0.8	0.5 - 0.9	0.5 - 1.3	0.5 - 1.4	0.5 - 1.5	0.5 - 1.8	0.5 - 2.0	0.5 - 2.3								
					F32	F22	F16	F11	0.5 - 0.5	0.5 - 0.6	0.5 - 0.9	0.5 - 1.0	0.5 - 1.1	0.5 - 1.3	0.5 - 1.5	0.5 - 1.6								

The above table shows the light control ranges in the off-flash condition.

The displayed nearer value is 0.6 or more when the light emission section faces the front and 0.5 or more when it faces downward.

<MANUAL>

In this mode, the flash is emitted according to the guide number (GN) setting.

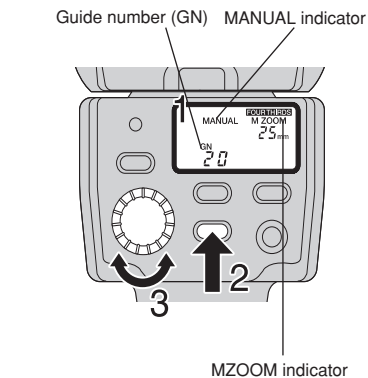

1. The control panel shows the current guide number (GN).
2. Adjust the MZOOM indicator according to the focal length of the lens.
3. Turn the select dial to set the guide number (GN).

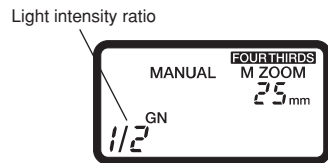

In the Custom Setup mode, the flash intensity can be displayed in a light intensity ratio instead of the guide number (see page 49).

Light intensity ratio: Ratio of emitted light intensity with respect to the intensity at full emission.

How to determine the lens iris (F), guide number (GN) and shooting distance

1. When the shooting distance and lens iris are already determined:

Determine the guide number (GN) with the following formula and set the GN on the FL-36.

$$\text{Guide number (GN)} = \frac{\text{Lens iris (F)} \times \text{Shooting distance (m)}}{\text{ISO speed coefficient}}$$

2. When it is necessary to determine the lens iris (F):

Determine the lens iris (F) with the following formula and set F on the FL-36.

$$\text{Lens iris (F)} = \frac{\text{Guide number (GN)} \times \text{ISO speed coefficient}}{\text{Shooting distance (m)}}$$

3. When it is necessary to determine the optimum shooting distance:

$$\text{Optimum shooting distance (m)} = \frac{\text{Guide number (GN)} \times \text{ISO speed coefficient}}{\text{Lens iris (F)}}$$

ISO speeds and their coefficients

ISO speed	25	50	100	200	400	800	1600	3200
Coefficient	0.5	0.71	1.0	1.4	2.0	2.8	4.0	5.6

See page 52 for the guide number list.

OTHER OPERATIONS

Bounce Shooting

Bounce shooting refers to a method in which the light from the flash is bounced off the ceiling or walls. This allows the light to go all around the subject, resulting in a soft picture without harsh contrast or shadow.

Shooting without bounce



Bounce shooting



Operation

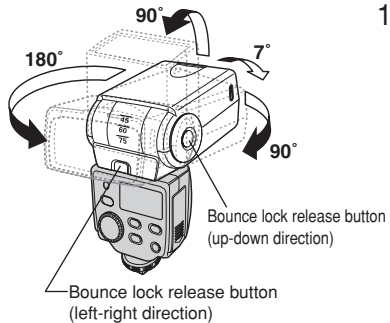

1. While holding the Bounce lock release button, revolve the light-emitting section in the up-down and left-right directions.

The light-emitting section can be revolved in the range shown in the figure on the left.

Down: 7°
(See "Close-up Flash" on page 41.)

If the position of the light-emitting section is locked, press and hold the Bounce lock release button and then change the position.

- The light control range and optimum shooting distance are not displayed in the control panel.
- The color of the surface (ceiling and/or walls) off which the light is bounced will affect the pictures you take. Whenever possible, bounce the light off a neutral surface.
- When the firing angle adjustment is automatic (ZOOM), the ZOOM display on the control panel shows "--" and the firing angle is set to 25 mm (50 mm with 135 type).
- When the firing angle adjustment is based on manual switching (M ZOOM), the firing angle can be varied manually (see page 42).

Close-up Flash

The flash activation area is inaccurate when the subject distance is between 0.5 and 1.0 m. In this case, tilt the flash down.

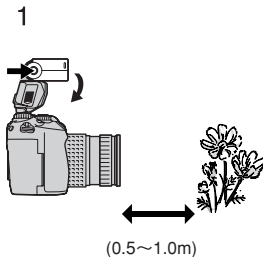

1. While keeping the Bounce lock button pressed, tilt the flash down (7°)
2. The close-up flash indicator lights in the control panel.

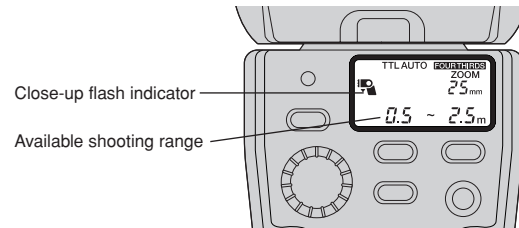

- The recommended range for this flash is 0.5 to 1.0 m.
- The available shooting range is displayed on the control panel. The maximum shooting distance is 2.5 m.
- The flash light may be blocked when the lens is long or large in diameter. Be sure to perform test shooting.
- Do not tilt the flash down in normal shooting. This will darken the upper part of the image.

Manual Switching of Firing angle (ZOOM)

The firing angle can be adjusted manually.

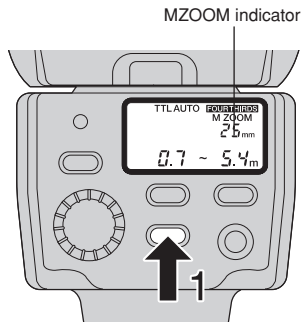

1. Press the ZOOM button to adjust the firing angle.
 - The M ZOOM indicator lights in the control panel.
 - The firing angle can be set to one of 12, 14, 17, 25, 35 and 42 mm (24, 28, 35, 50, 70 and 85 mm with 135 type). Each press of the ZOOM button switches the firing angle as follows.
 - The ZOOM indicator lights in AUTO ZOOM mode.

AUTO	→	12	→	14	→	17	→	25	→	35	→	42
ZOOM		(24)		(28)		(35)		(50)		(70)		(85)

When the wide panel is used: (see page 43)

AUTO	→	10	→	8
ZOOM		(20)		(16)

- AUTO ZOOM can be selected only when the camera in use is equipped with the communication capability.

Note

Selecting a ZOOM value larger than your lens's focal length will darken the peripheral areas of the image.

Using the Wide Panel

Use the built-in wide panel in flash shooting when the lens focal length is set to a wider position than 12 mm.

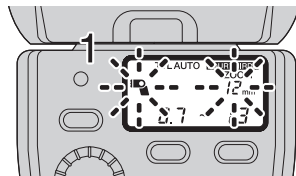

1. When the lens focal length is shorter than 12 mm (24 mm with the 135 type), the wide panel warming indicator lights in the control panel.
(This does not occur if the camera is not equipped with communication capability.)

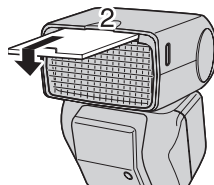

2. Slide out the wide panel and place it on the light-emitting area.
 - The wide panel indicator lights in the control panel.

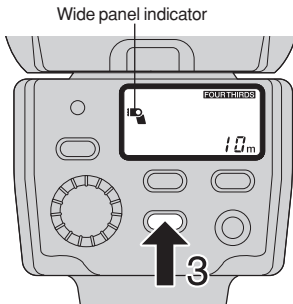

3. Press the ZOOM button to select the firing angle from 8 mm and 10 mm (16 mm and 20 mm with the 135 type).

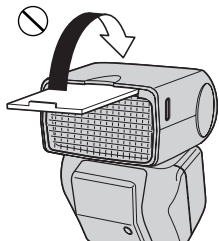

- When the wide panel is used, the actual guide number (GN) will be lower than set. In the TTL AUTO, AUTO and FP TTL AUTO modes, this results in a reduction of the available shooting range. In the MANUAL and FP MANUAL modes, this results in a reduction of the optimum shooting range.
- Be sure to store the wide panel again after shooting.
- To prevent damage to the wide panel, do not flip it in the upward direction.
- If the wide panel is damaged when it is slid out, the ZOOM button will no longer be operable. If that happens, disable the wide panel switch to restore operability (page 47).

Various Flash Shooting Methods

The following flash shooting methods are possible according to the camera setup.

- Some flash shooting methods may be unavailable depending on the function and design of the camera.
- For details on operating procedure, refer to the instruction manual for your camera.

1. Red eye-reduction flash



Reduces the appearance of red eyes due to flash emission.

2. Slow sync



The flash is emitted with slow shutter. This makes it possible to take clear pictures of subjects against a night background.

3. Background screen sync



Slow shutter is used and the flash is emitted immediately before the end of exposure period.

This makes it possible to take pictures of moving objects such as car taillights with a streaming effect.

4. Combination with camera's built-in flash



When the camera in use has a built-in flash, it can be used simultaneously with the electronic flash.

- Advanced shooting techniques are possible. For example, you can bounce the light from the electronic flash off the wall or ceiling while using the camera's built-in flash for a catch-light effect.
- With certain camera models, the built-in flash may be disabled when the electronic flash is mounted on the camera's hot shoe.

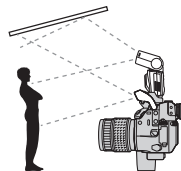

■ Note

The electronic flash control mode should be set to TTL AUTO or FP TTL AUTO.





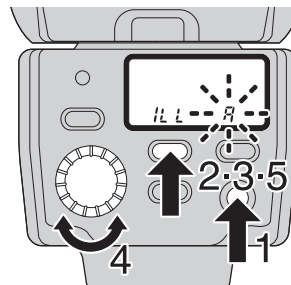











CUSTOM SETUP









Custom setup allows each user to customize flash setup to suit his or her preferences.



Setup procedure

1. Turn the electronic flash on.
2. Press and hold the MODE button for more than 2 seconds, until the setup mode display appears in the control panel.
3. Press the MODE button momentarily to select the setup mode.
4. Turn the select dial to select the value.
5. Keep the MODE button pressed for more than 2 seconds to exit from setup and return to the previous control panel display.

Setup mode	Mode display	Value display	Function	Default
	Dial A	Dial B		
AF illuminator Only works with the Olympus Four Thirds System digital SLR camera. It does not work with other cameras.			AF illuminator is activated according to the control from the camera.	A
			AF illuminator is defeated.	
Flash cable			Use this setting when not using the flash cable (clipping on to the hot shoe).	on
			Use this setting when using the flash cable (off flash cable).	
Firing angle (ZOOM) display			Firing angle (ZOOM) is displayed in terms of the lens focal length of a FOUR THIRDS digital camera.	4-3
			Firing angle (ZOOM) is converted into the focal distance of the 135 type. This allows the flash to be used in the same feeling as the flash for a 135 type (35 mm film) camera.	
Distance display unit			Distance is displayed in meters.	m
			Distance is displayed in feet.	
Light intensity adjustment			Light intensity cannot be adjusted.	OFF
			Light intensity can be adjusted.	

Setup mode	Mode display	Value display	Function	Default
	Dial A	Dial B		
Wide panel switch disabling			The wide panel switch is activated. Use this setting to detect that the wide panel has been slid out.	on
			The wide panel switch is deactivated. Use this setting when the wide panel is damaged so that the firing angle can be changed with the ZOOM button.	
GN (guide number) indicator			The flash intensity is displayed in a GN (guide number).	on
			The flash intensity is displayed in a light intensity ratio.	
ISO and F communication in AUTO mode Only works with a camera with ISO speed setting communication capability in AUTO mode.			The ISO speed and lens iris (F) are automatically set by the camera side.	on
			The ISO speed and lens iris (F) can be set with the select dial.	

Setup mode	Mode display	Value display	Function	Default
	Dial A	Dial B		
ISO speed selection in AUTO mode Works with a camera without ISO speed setting communication capability in AUTO mode. Also works with a camera with ISO speed setting communication capability in AUTO mode when the ISO and F communication in AUTO mode is set to OFF.	ISO		The ISO speed can be set with the select dial.	100

ALL RESET

All Reset resets the custom setups to the factory default settings.

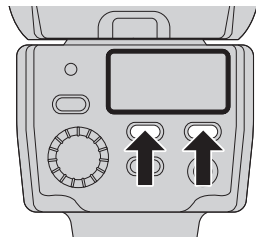

- Press the MODE and LIGHT buttons simultaneously for 2 or more seconds to reset the custom setups (except for the distance display unit (m/ft)) to the default settings.
- The distance display unit (m/ft) is not altered by the all reset operation.

CONTINUOUS FIRING

Continuous firings make the light-emitting section hot and may cause it to deteriorate or malfunction. Therefore, continuous firing should be limited to the counts shown in the following table. Always leave the electronic flash unused for at least 10 minutes after continuous firing up to the limit count.

■ Limit counts of continuous firings

Flash control mode	Light intensity ratio	Flash interval	Limit count
TTL AUTO	1/1	6 sec.	10
AUTO	1/2	3 sec.	20
MANUAL	1/4	1 sec.	40
FP AUTO	1/8 to a/128	0.5 sec. or less	80

GUIDE NUMBER (GN) LIST

• TTL AUTO/AUTO

ISO100, m

ZOOM (mm)	FOUR THIRDS	8	10	12	14	17	25	35	42
	With 135	16	20	24	28	35	50	70	85
TTL AUTO/AUTO	Full emission	12	14	20	22	26	28	32	36

• MANUAL

ISO100, m

ZOOM (mm)	FOUR THIRDS	8	10	12	14	17	25	35	42
	With 135	16	20	24	28	35	50	70	85
MANUAL Light intensity ratio	1/1	12.0	14.0	20.0	22.0	24.0	28.0	32.0	36.0
	1/2	8.5	9.9	14.1	15.6	17.0	19.8	22.6	25.5
	1/4	6.0	7.0	10.0	11.0	12.0	14.0	16.0	18.0
	1/8	4.2	4.9	7.1	7.8	8.5	9.9	11.3	12.7
	1/16	3.0	3.5	5.0	5.5	6.0	7.0	8.0	9.0
	1/32	2.1	2.5	3.5	3.9	4.2	4.9	5.7	6.4
	1/64	1.5	1.8	2.5	2.8	3.0	3.5	4.0	4.5
	1/128	1.1	1.2	1.8	1.9	2.1	2.5	2.8	3.2

• FP TTL AUTO

ISO100, m

ZOOM (mm)	FOUR THIRDS	8	10	12	14	17	25	35	42
	With 135	16	20	24	28	35	50	70	85
Shutter speed	1/125	8.5	9.9	14.1	15.6	17.0	19.8	22.6	25.5
	1/160	7.5	8.8	12.5	13.8	15.0	17.5	20.0	22.5
	1/200	6.7	7.8	11.2	12.3	13.4	15.7	17.9	20.1
	1/250	6.0	7.0	10.0	11.0	12.0	14.0	16.0	18.0
	1/320	5.3	6.2	8.8	9.7	10.6	12.4	14.1	15.9
	1/400	4.7	5.5	7.9	8.7	9.5	11.1	12.6	14.2
	1/500	4.2	4.9	7.1	7.8	8.5	9.9	11.3	12.7
	1/640	3.8	4.4	6.3	6.9	7.5	8.8	10.0	11.3
	1/800	3.4	3.9	5.6	6.1	6.7	7.8	8.9	10.1
	1/1000	3.0	3.5	5.0	5.5	6.0	7.0	8.0	9.0
	1/1250	2.7	3.1	4.5	4.9	5.4	6.3	7.2	8.0
	1/1600	2.4	2.8	4.0	4.3	4.7	5.5	6.3	7.1
	1/2000	2.1	2.5	3.5	3.9	4.2	4.9	5.7	6.4
	1/2500	1.9	2.2	3.2	3.5	3.8	4.4	5.1	5.7
	1/3200	1.7	2.0	2.8	3.1	3.4	3.9	4.5	5.0
	1/4000	1.5	1.8	2.5	2.8	3.0	3.5	4.0	4.5
1/5000	1.3	1.6	2.2	2.5	2.7	3.1	3.6	4.0	
1/6400	1.2	1.4	2.0	2.2	2.4	2.8	3.2	3.6	
1/8000	1.1	1.2	1.8	1.9	2.1	2.5	2.8	3.2	

• FP MANUAL

The following guide number (GN) figures have a 1/1 light intensity ratio.

ISO100·m

ZOOM (mm)	FOUR THIRDS	8	10	12	14	17	25	35	42
	With 135								
Shutter speed	1/125	8.5	9.9	14.1	15.6	17.0	19.8	22.6	25.5
	1/160	7.5	8.8	12.5	13.8	15.0	17.5	20.0	22.5
	1/200	6.7	7.8	11.2	12.3	13.4	15.7	17.9	20.1
	1/250	6.0	7.0	10.0	11.0	12.0	14.0	16.0	18.0
	1/320	5.3	6.2	8.8	9.7	10.6	12.4	14.1	15.9
	1/400	4.7	5.5	7.9	8.7	9.5	11.1	12.6	14.2
	1/500	4.2	4.9	7.1	7.8	8.5	9.9	11.3	12.7
	1/640	3.8	4.4	6.3	6.9	7.5	8.8	10.0	11.3
	1/800	3.4	3.9	5.6	6.1	6.7	7.8	8.9	10.1
	1/1000	3.0	3.5	5.0	5.5	6.0	7.0	8.0	9.0
	1/1250	2.7	3.1	4.5	4.9	5.4	6.3	7.2	8.0
	1/1600	2.4	2.8	4.0	4.3	4.7	5.5	6.3	7.1
	1/2000	2.1	2.5	3.5	3.9	4.2	4.9	5.7	6.4
	1/2500	1.9	2.2	3.2	3.5	3.8	4.4	5.1	5.7
	1/3200	1.7	2.0	2.8	3.1	3.4	3.9	4.5	5.0
	1/4000	1.5	1.8	2.5	2.8	3.0	3.5	4.0	4.5
	1/5000	1.3	1.6	2.2	2.5	2.7	3.1	3.6	4.0
1/6400	1.2	1.4	2.0	2.2	2.4	2.8	3.2	3.6	
1/8000	1.1	1.2	1.8	1.9	2.1	2.5	2.8	3.2	

The guide numbers (GN) for light intensity ratios other than 1/1 in the FP MANUAL mode can be calculated with the following formula.



$$\text{Guide number (GN)} = \text{Guide number at 1/1} \times \text{Light intensity ratio coefficient}$$



Light intensity ratios and their coefficients

Light intensity ratio	1/1	1/2	1/4	1/8	1/16
Coefficient	1.0	0.71	0.5	0.35	0.25

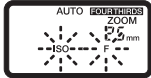
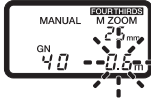
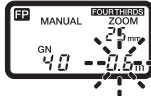

WARNING DISPLAY LIST

• Digital camera with communication capability

Warning details	Control panel display	Remedy	Ref. Page
Out of light control range in AUTO mode		Change the camera's ISO speed or lens iris (F) setting.	P. 24
Subject too close in MANUAL mode		① Change the camera's ISO speed or lens iris (F) setting. ② Change the guide number (GN) setting.	P. 27
Subject too close in FP MANUAL mode		① Change the camera's ISO speed or lens iris (F) setting. ② Change the guide number (GN) setting.	P. 32
Wide panel request in all modes		Set the wide panel.	P. 43

Warning details	Control panel display	Remedy	Ref. Page
Downward bounce in all modes		The light-emitting section is set at 7° downward. Cancel this setting except for close-up flash photography.	P. 41
Wide panel warning in all modes		The wide panel is set. Pay attention to the distance to the subject since a lower guide number (GN) is selected.	P. 43

• Digital camera without communication capability

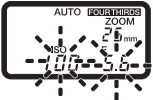
Warning details	Control panel display	Remedy	Ref. Page
Downward bounce in all modes		The light-emitting section is set at 7° downward. Cancel this setting except for close-up flash photography.	P. 41
Wide panel warning in all modes		The wide panel is set. Pay attention to the distance to the subject since a lower guide number (GN) is selected.	P. 43
Out of light control range in AUTO mode		Change the camera's ISO speed or lens iris (F) setting.	P. 35

Q&A

Q Is multi-flash shooting possible in the TTL AUTO mode?

A No, it is not possible.

Q When are test flash activation and auto checking effective?

A Checking the optimum flash activation based on the AUTO CHECK lamp is particularly effective in bounce flash (in AUTO modes only).

Q What will happen if the electronic flash is activated simultaneously with the camera's built-in flash?

A In the TTL mode, both flashes emit light simultaneously and the optimum exposure is determined according to the combined total light intensity (provided that the camera is in the P or A shooting mode). In bounce flash photography, the camera's built-in flash can also be used for catch-light photography (see page 46).

Q Why does the electronic flash get hot after successive firing?

A The batteries generate heat when flash firing is repeated successively. In this case, use the electronic flash at intervals until the flash emission section and batteries cool down.

Q Why can't I mount the electronic flash on the camera?

A The electronic flash cannot be mounted if the lock pin is in the out position. If this is the case, turn the lock ring all the way in the opposite direction to [←LOCK] until it stops. Once the lock pin is in the in position, you can mount the electronic flash on the camera (see page 18).

Q Why doesn't the control mode change when I press the MODE button?

A When the electronic flash is connected to certain types of communication-capable camera, the flash control mode can only be controlled from the camera.

Q The picture is overexposed. What should I do?

A First check the shooting range displayed on the control panel. If your subject is closer than the displayed shooting range, try one of the following so that the shooting range becomes valid to your subject.

- Stop down the lens aperture.
- Set the light intensity adjustment value to the negative side (-).
- Use the wide panel.

Q What is the recommended white balance setting for the camera when using the flash?

A The auto white balance mode is recommended. If you use the manual white balance mode, set the color temperature to 5500K. Note that the color temperature varies depending on the flash shooting conditions.

Q The light control range is not displayed on the control panel. What is wrong?

A The light control range is not displayed in the following cases:

- When the Extension Tube EX-25 (optional) is used
- When the lens is removed
- During bounce photography
- During light intensity adjustment
- When the ISO speed and lens iris (F) are out of the setting range

Q When the Olympus E-1 digital camera enters the sleep mode, the FL-36 control panel displays turn off. Is this normal?

A Yes, it is normal. When the E-1 enters the sleep mode, the FL-36 does as well. When the camera wakes up, so does the FL-36.

Q Does the FL-36 also turn off when the Olympus E-1 digital camera is turned off?

A When the E-1 is turned off, the FL-36 enters the sleep mode. When the E-1 is turned on again, the FL-36 also turns on. When you want to turn off the FL-36, turn off the FL-36 before turning off the E-1. In addition, when connected to a camera without communication capability, the FL-36 enters the sleep mode if it is not operated for about 15 minutes.

MAIN SPECIFICATIONS

Model Number	: FS-FL36
Type	: External electronic flash for digital still camera
Guide number	: Automatic switching 36: When in 42 mm (85 mm with 135 type) 20: When in 12 mm (24 mm with 135 type) 8/10 switching: When the wide panel is used.
Firing angle	: Automatic switching. At 12 mm: Up-down 61°, left-right 78°(equivalent to image angle of 12 mm lens)* At 42 mm: Up-down 21°, left-right 28°(equivalent to image angle of 42 mm lens)* When the wide panel is used for 8 mm: Up-down 83°, left-right 101° (equivalent to image angle of 8 mm lens)* * ZOOM values are the FOUR THIRDS camera values.
Flash emission period	: Approx. 1/20000 to 1/500 sec. (Variable according to the light intensity, except in FP emission.)
Flash emission count (at full activation)	: Approx. 150 times (using the LR6-type AA (R6) alkaline dry cell batteries) Approx. 320 times (using the LB-01 type lithium battery packs) (Variable depending on shooting conditions)
Recharge time (from full activation to charge lamp lighting)	: Approx. 7.5 seconds (using the AA (R6) alkaline manganese batteries) Approx. 6.5 seconds (using the LB-01 type lithium battery packs)
Flash modes	: TTL AUTO, AUTO, MANUAL, FP TTL AUTO, FP MANUAL
Bounce angles	: Up 0 to 90°, down 7°, right 0 to 90°, left 0 to 180°
Auto power OFF	: Interlocks with the auto power OFF operation of a camera with communication capability

AF illuminator	: Automatic firing at low intensity, possible only when a camera with communication capability is connected. Standard effective distances (Variable depending on the camera and lens in use.) 1 to 5 m (3.3 to 16.4 ft)
Power supply	: AA (R6) alkaline dry cell batteries (LR6) x 2, AA (R6) Ni-Cd batteries x 2, AA (R6) Ni-Mh batteries x 2, AA (R6) Ni-Mn batteries (ZR6) x 2, AA (R6) oxyride batteries (ZR6Y type) x 2, AA (R6) lithium batteries (FR6) x 2 or 3 V lithium battery pack (Olympus LB-01) x 1
Dimensions	: 67(W) x 108(H) x 95(D) mm (2.6 x 4.3 x 3.7 in) (excluding protrusions)
Weight	: 210 g (7.4 oz) (excluding batteries)
Operating environment	: Temperature: 0 to 40°C (32 to 104°F) Humidity: No more than 80% (without condensation)

Specifications are subject to change without any notice or obligation on the part of the manufacturer.

- Technical Support (USA)
24/7 online automated help: <http://www.olympusamerica.com/E1>
Phone customer : Tel.1-800-260-1625 (Toll-free)
Our phone customer support is available from 8 am to 10 pm (Monday to Friday) ET
E-Mail : e-slrpro@olympusamerica.com
- European technical Customer Support
Please visit our homepage <http://www.olympus-europa.com>
or call NUMBER : Tel.00800-67 10 83 00 (Toll-free)
+49 1805-67 10 83 or +49 40-23 77 38 99 (Charged)

OLYMPUS[®]

<http://www.olympus.com/>

OLYMPUS IMAGING CORP.

Shinjuku Monolith, 3-1, Nishi Shinjuku 2-chome, Shinjuku-ku, Tokyo, Japan
Customer support (Japanese language only): Tel. 0426-42-7499 Tokyo

OLYMPUS IMAGING AMERICA INC.

Two Corporate Center Drive, Po Box 9058, Melville, NY 11747-9058, U.S.A. Tel. 631-844-5000

OLYMPUS EUROPA GMBH

Premises : Wendenstrasse 14-18, 20097 Hamburg, Germany
Tel: +49 40-23 77 3-0 Fax: +49 40-23 07 61
Goods delivery : Bredowstrasse 20, 22113 Hamburg, Germany
Letters : Postfach 10 49 08, 20034 Hamburg, Germany

© 2004 **OLYMPUS IMAGING CORP.**

Printed in China

VM040902