



DVD-VCR

CHT-250



Instruction Manual

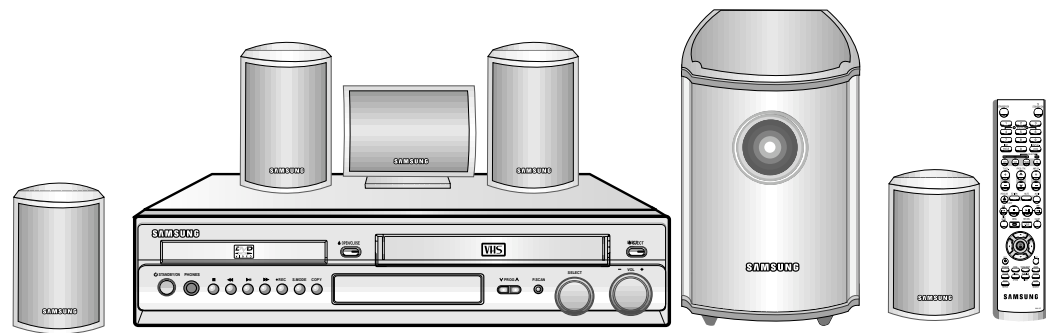

Contents

◆ FOREWORD	
■ Safety Instructions	5
■ Disc Type and Characteristics	6
◆ DVD-VCR OVERVIEWS	
■ Front View of the DVD-VCR	7
■ Rear View of the DVD-VCR	7
■ Infrared Remote Control	8
■ Display Indicators	9
■ Accessories	9
◆ CONNECTING YOUR DVD-VCR	
■ Deciding How to Connect DVD-VCR	10
■ Connecting DVD-VCR to the TV using the Coaxial Cable	11
■ Connecting DVD-VCR to the TV using the RCA Cable	11
■ Connecting DVD-VCR to a Satellite Receiver or Other Equipment	12
■ Plug & Auto Set up	13
■ Tuning Your Television for the DVD-VCR	14
■ Deck Control Keys	15
■ Basic TV Tuner Operations	16
■ Inserting Batteries in the Remote Control	16
■ Copying from DVD to VCR	17
■ Setting the Date and Time	18
■ Setting the Menu Language	18
◆ SETTING UP YOUR DVD-VCR	
■ Presetting the Stations Automatically	19
■ Presetting the Stations Manually	20
■ Clearing a Preset Station	21
■ Changing the Preset Station Table	22
■ Selecting the RF OUT Sound Mode (B/G-D/K)	23
■ Setting the DVD-VCR Output Channel	23
■ Selecting the Colour Mode	24
■ NICAM	25
■ Intelligent Picture Control	26
■ Intelligent Picture Control (Remote Control)	26
■ Auto Power off	27
■ Screen Messages	28
■ Selecting the Cassette Type	28
■ Repeat Play	29
■ S-VHS Play	29

Contents

◆ RECORDING TELEVISION BROADCASTS	
■ Selecting the Recording Speed	30
■ Protecting a Recorded Cassette	31
■ Recording a Programme Immediately	31
■ Recording a Programme with Automatic Stop	32
■ Using the Timer Programming Feature	33
■ Checking a Preset Recording	34
■ Cancelling a Preset Recording	34
◆ PLAYING BACK	
■ Playing a Cassette	35
■ Adjusting Picture Alignment Manually	35
■ Selecting the Audio Output Mode	36
■ Playing a Cassette in Slow Motion	36
■ Playing a Sequence at Variable Speeds	37
■ Searching for a Specific Sequence	38
■ Using the Tape Counter	40
■ Connecting an RCA Audio/Video Input Cable	41
■ Recording from Another VCR or Camcorder	42
■ Audio Dubbing a Pre-recorded Cassette	43
■ Using the TV Buttons on the Remote Control	44
◆ DVD FUNCTIONS	
■ Choosing a Connection	45
■ Setting Up the Language Features	46
■ Setting Up the Audio Options	48
■ Setting Up the Parental Control	49
■ Setting Up the Display Options	50
■ S-Video Connections (for DVD)	50
■ Component Connections (for DVD)	51
■ Special Playback Features	52
■ Adjusting the Aspect Ratio (EZ View)	53
■ Using the Display Function (DVD/VCD/CD)	55
■ Changing the Camera Angle	56
■ Selecting the Subtitle Language	56
■ Repeat Play	57
■ Using the Zoom (DVD/VCD)	57
■ Repeat Chapter/Title	58
■ Selecting the Audio Language	58
■ Using the Mark Function (DVD/VCD)	59
■ MP3-CD Playback	60
■ WMA Play	61
■ MP3/WMA Play	62
■ Program Play & Random Play	63
■ Picture CD Playback	64

◆ APPENDIX A - ADVANCED CONNECTIONS





- Setting the Delay Time 66
- About Speaker Setup..... 67
- Sound Mode Function..... 69
- Listening to the Radio 70
- Presetting Stations..... 71

◆ SOLVING PROBLEMS

- Technical Specifications 72
- Problems and Solutions (VCR)..... 73
- Troubleshooting Guide (DVD) 74

This product incorporates copyright protection technology that is protected by method claims of certain U.S. patents and other intellectual property rights owned by Macrovision Corporation and other rights owners. Use of this copyright protection technology must be authorized by Macrovision Corporation, and is intended for home and other limited viewing uses only unless otherwise authorized by Macrovision Corporation. Reverse engineering or disassembly is prohibited.

Symbols

			
Press/push	Hold down	Important	Note
① = Step number			

The following illustrations represent precautions.



The lightning bolt is a warning sign alerting you to dangerous voltage inside the product.
DO NOT OPEN THE DVD-VCR. Refer to service personnel.

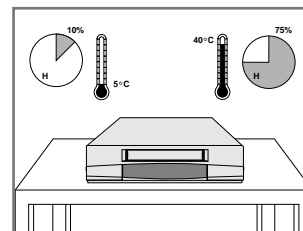

Do NOT expose the DVD-VCR to extreme temperature conditions (below 5°C and above 40°C) or to extreme humidity conditions (less than 10% and more than 75%).

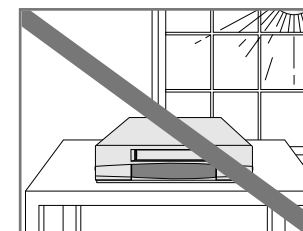

Do NOT expose the DVD-VCR to direct sunlight.

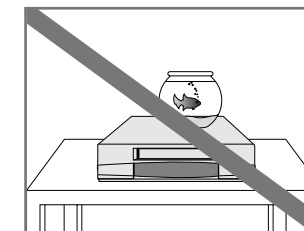

Do NOT expose the DVD-VCR to any liquids.

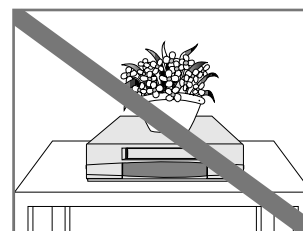

Do NOT place any objects on the DVD-VCR or remote control.

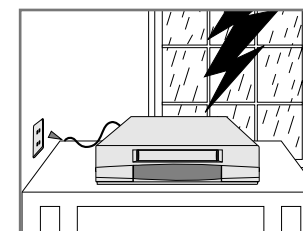

During a storm and/or lightning, unplug the DVD-VCR from the mains socket and aerial.

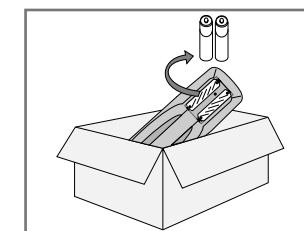



If the remote control is not used for a long period of time, remove the batteries and store it in a cool, dry place.

THIS DEVICE IS NOT FOR USE IN INDUSTRIAL ENVIRONMENTS

Disc Type and Characteristics







This DVD player is capable of playing the following types of discs with the corresponding logos :

Disc Types (Logos)	Recording Types	Disc Size	Max. Playing Time	Characteristics
 DVD	Audio + Video	12 Cm	Single-sided 240 min. Double-sided 480 min.	<ul style="list-style-type: none"> DVD contains excellent sound and video due to Dolby Digital and MPEG-2 system. Various screen and audio functions can be easily selected through the on-screen menu.
		8 Cm	Single-sided 80 min. Double-sided 160 min.	
 VIDEO-CD	Audio + Video	12 Cm	74 min.	<ul style="list-style-type: none"> Video with CD sound, VHS quality & MPEG-1 compression technology.
		8 Cm	20 min.	
 AUDIO-CD	Audio	12 Cm	74 min.	<ul style="list-style-type: none"> An LP is recorded as an analog signal with more distortion. CD is recorded as a Digital Signal with better audio quality, less distortion and less deterioration of audio quality over time.
		8 Cm	20 min.	

* DO NOT play CD-ROM, CD-I and DVD-ROM in this player!
(CDGs play audio only, not graphics.)

* It may not be to play CD-R, CD-RW and DVD-R in all cases due to the type of disc or condition of the recording.

Disc Markings

						
• Playback Region Number	• PAL colour system in U.K, France, Germany, etc.	• NTSC broadcast system in USA, Canada, Japan, South Korea, etc.	• Dolby Digital disc	• Stereo disc	• Digital Audio disc	• DTS disc

- "DTS" and "DTS Digital Surround" are registered trademarks of Digital Theater Systems, Inc.
- Manufactured under license from Dolby Laboratories.
"Dolby", "Pro Logic", and the double-D symbol are trademarks of Dolby Laboratories.

Playback Region Number

Both the DVD player and the discs are coded by region. These regional codes must match in order for the disc to play. If the codes do not match, the disc will not play.

The Region Number for this player is described on the rear panel of the player.

Front View of the DVD-VCR

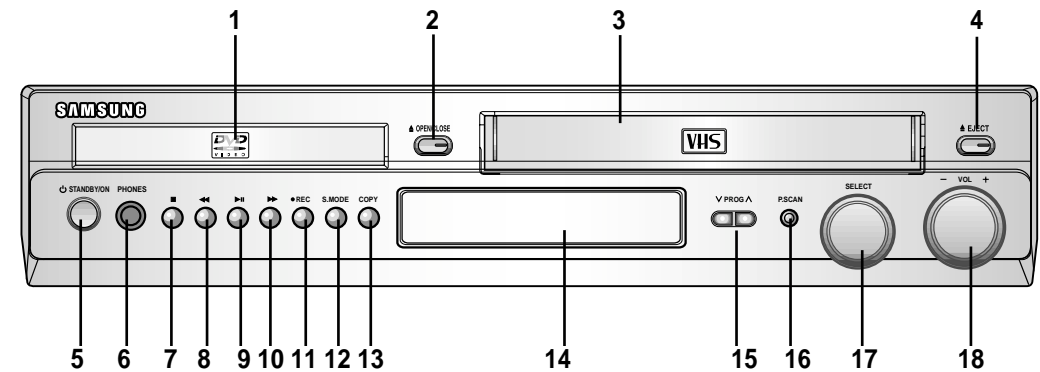

- | | |
|------------------------|-------------------------|
| 1 DVD DECK | 10 F.F/SKIP NEXT BUTTON |
| 2 DVD OPEN/CLOSE | 11 RECORD |
| 3 VCR DECK | 12 SOUND MODE |
| 4 VCR EJECT | 13 COPY |
| 5 STANDBY/ON | 14 FRONT PANEL DISPLAY |
| 6 HEADPHONE JACK | 15 PROGRAMME ^ / V |
| 7 STOP | 16 PROGRESSIVE SCAN |
| 8 REW/SKIP BACK BUTTON | 17 SELECT DIAL |
| 9 PLAY/STILL | 18 VOLUME DIAL |

Rear View of the DVD-VCR

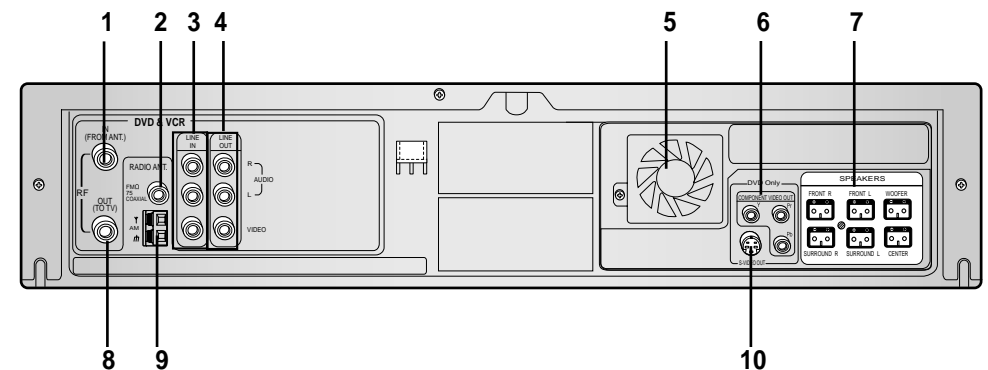

- | | |
|--------------------------|--------------------------|
| 1 RF ANTENNA INPUT | 6 COMPONENT VIDEO OUT |
| 2 RADIO FM ANTENNA INPUT | 7 5.1CH SPEAKER OUT |
| 3 LINE IN | 8 RF OUT TO TV |
| 4 LINE OUT | 9 RADIO AM ANTENNA INPUT |
| 5 COOLING FAN | 10 S-VIDEO OUT |

Infrared Remote Control

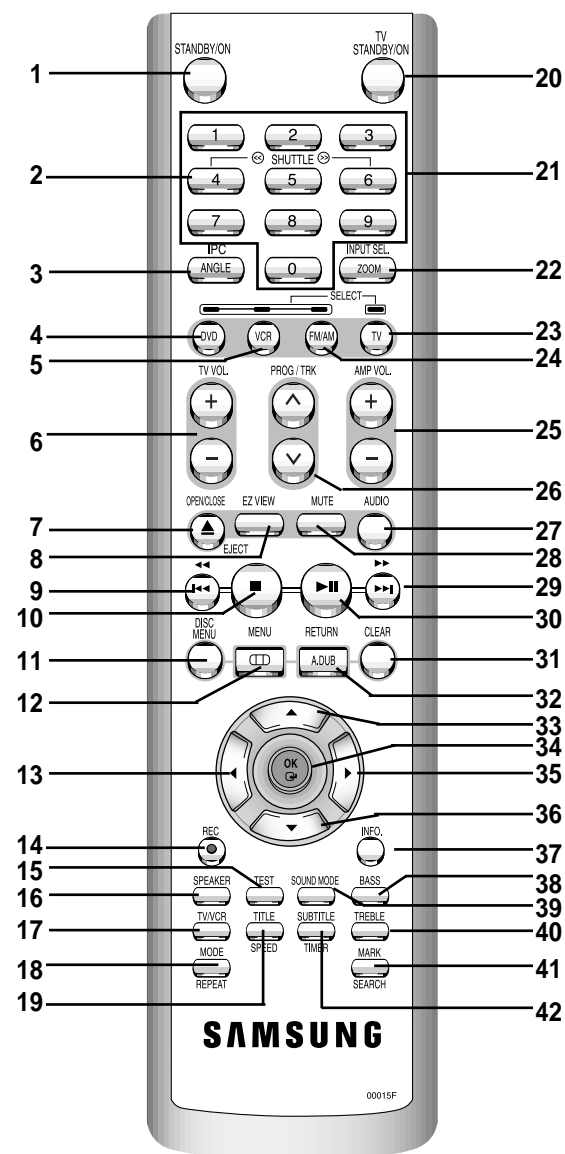

- 1 STANDBY/ON
- 2 SHUTTLE<< / >>
- 3 ANGLE/IPC
- 4 DVD SELECT
- 5 VCR SELECT
- 6 TV VOLUME
- 7 OPEN/CLOSE, EJECT
- 8 EZ VIEW
- 9 REWIND, SKIP BACK
- 10 STOP
- 11 DISC MENU
- 12 MENU
- 13 LEFT
- 14 RECORD
- 15 TEST
- 16 SPEAKER
- 17 TV/VCR
- 18 MODE, REPEAT
- 19 TITLE, SPEED
- 20 TV STANDBY/ON
- 21 0-9
- 22 ZOOM, INPUT SELECT
- 23 TV SELECT
- 24 FM/AM SELECT
- 25 AMP VOLUME
- 26 PROG/TRK (^ , v)
- 27 AUDIO
- 28 MUTE
- 29 FAST-FORWARD, SKIP NEXT
- 30 PLAY/STILL
- 31 CLEAR
- 32 RETURN, A.DUB
- 33 UP
- 34 OK
- 35 RIGHT
- 36 DOWN
- 37 INFO.
- 38 BASS
- 39 SOUND MODE
- 40 TREBLE
- 41 MARK, SEARCH
- 42 SUBTITLE, TIMER

Display Indicators

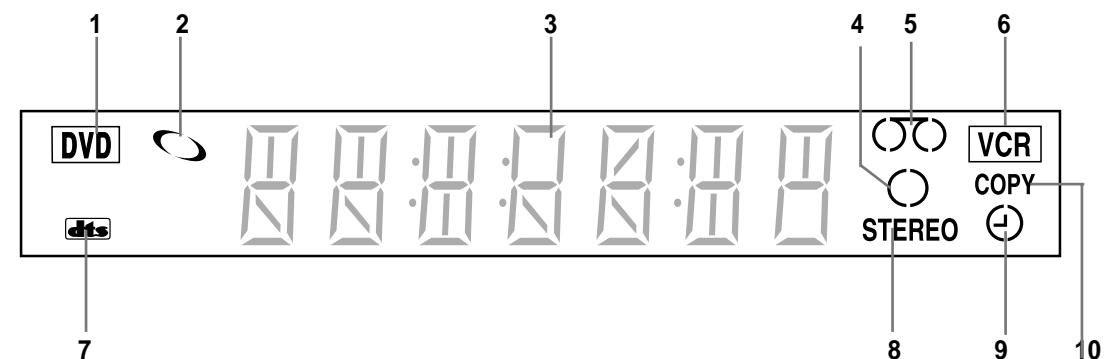

- 1 The DVD Deck is active.
- 2 DVD or CD, VCD, SVCD media is loaded.
- 3 The time, counter position, time remaining or current deck status is indicated.
- 4 Recording is in progress (normal and timer).
- 5 VHS videotape is loaded.
- 6 The VCR Deck is active.
- 7 A DVD with a DTS soundtrack is loaded.
- 8 The Hi-Fi track of a VHS videotape is playing or the current TV program or video is broadcast in Stereo.
- 9 Timer Recording is in progress. When it blinks an error has occurred. When recording is on, it displays without the clock hands. It also blinks when you pause the VCR.
- 10 COPY mode indicator

Accessories

You have just purchased a SAMSUNG Video Cassette Recorder (DVD-VCR). Together with your DVD-VCR, you will find the following accessories in the box.

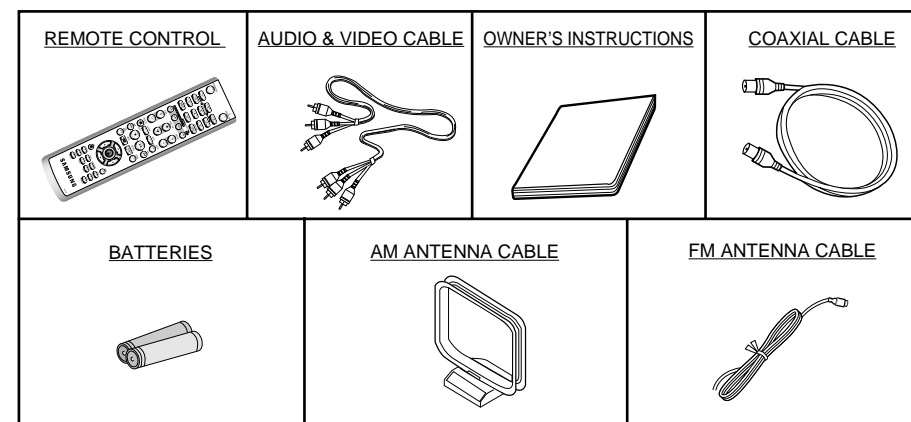









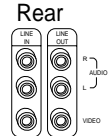



Deciding How to Connect DVD-VCR

You must take into account various factors when connecting audio or video systems:

- ◆ Types of connectors available on your systems
- ◆ Systems connected permanently to the DVD-VCR (satellite receiver for example) or temporarily (camcorder for example)

Your DVD-VCR is equipped with the following connectors.

Connector	Location	Type	Direction	Recommended Use
LINE	Rear 	Audio/Video RCA	In/Out 	◆ Television ◆ Other VCR
COMPONENT output	Rear 	RCA	Out 	◆ COMPONENT out (DVD only)
S-VIDEO output	Rear 	S-JACK	Out 	◆ S-Video out (DVD only)
OUT TO TV	Rear 	75 Ω coaxial	Out 	◆ Television
IN FROM ANT.	Rear 	75 Ω coaxial	In 	◆ Aerial ◆ Cable television network ◆ Satellite receiver
FM/AM Antenna Input	Rear 	75 Ω coaxial	In 	◆ FM Antenna ◆ AM Antenna

Whenever you connect an audio or video system to your DVD-VCR, ensure that all elements are switched off.

Refer to the documentation supplied with your equipment for detailed connection instructions and associated safety precautions.

Connecting DVD-VCR to the TV using the Coaxial Cable

To receive television programmes a signal must be received from one of the following sources:

- ◆ An outdoor aerial
- ◆ An indoor aerial
- ◆ A cable television network
- ◆ A satellite receiver

Make sure that both the television and the DVD-VCR are switched off before connecting the cables.

- 1 Remove the aerial or network input cable from the television.
- 2 Connect this cable to the 75Ω coaxial socket marked (FROM ANT.) on the rear of your DVD-VCR.
- 3 Plug the coaxial cable supplied into the socket marked (TO TV) on your DVD-VCR.
- 4 Plug the other end of the coaxial cable into the connector previously used for the aerial on the television.
- 5 To obtain better quality pictures and sound on your television, you can also connect your DVD-VCR to the television via the RCA cable (see section below) if your television is equipped with this type of connection.

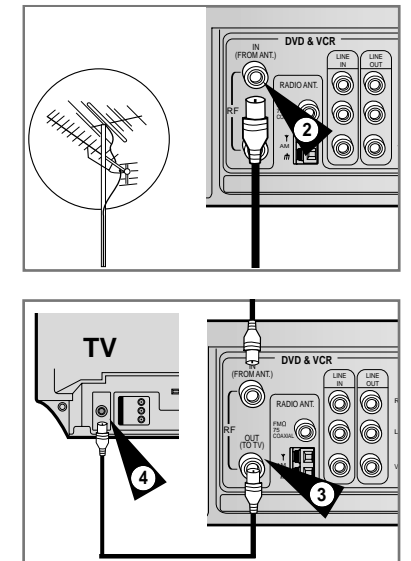

Connecting DVD-VCR to the TV using the RCA Cable

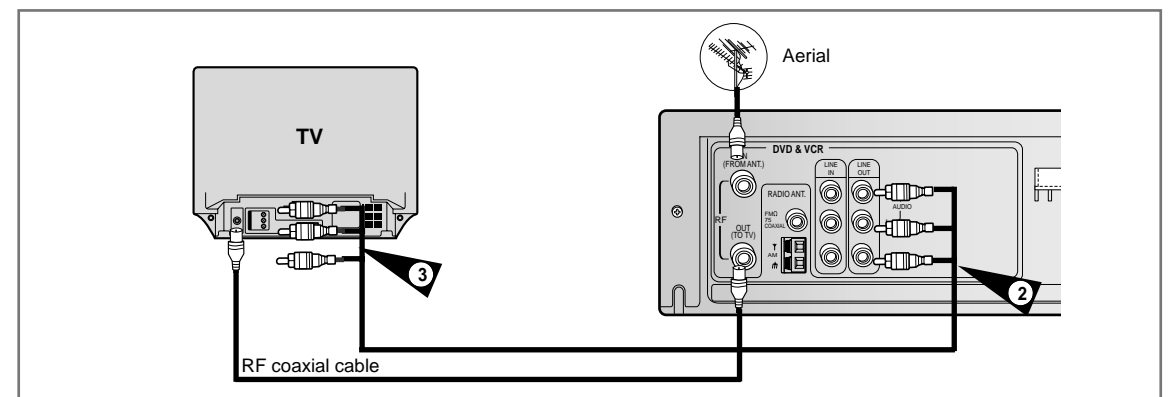

You can connect your DVD-VCR to the television using the RCA cable if the appropriate input is available on the television. You thus:

- ◆ Obtain better quality sound and pictures
- ◆ Simplify the setting up procedure of your DVD-VCR

Regardless of the type of connection chosen, you must always connect the coaxial cable supplied. Otherwise, no picture will be visible on the screen when the DVD-VCR is switched off.

Make sure that both the television and the DVD-VCR are switched off before connecting the cables.

- 1 Connect the coaxial cable as indicated in the above section.
- 2 Connect one end of the RCA Audio/Video cable to the Video output and Audio L, R output socket on the rear of the DVD-VCR.
- 3 Plug the other end into the appropriate connector on the television.

Connecting DVD-VCR to a Satellite Receiver or Other Equipment

You can connect other audio and/or video equipment to your DVD-VCR in different ways. The following illustrations give a few examples of the connection possibilities.

- The RCA input/output connectors on the rear of the DVD-VCR are used for equipment, such as camcorders, VCRs or sound systems.

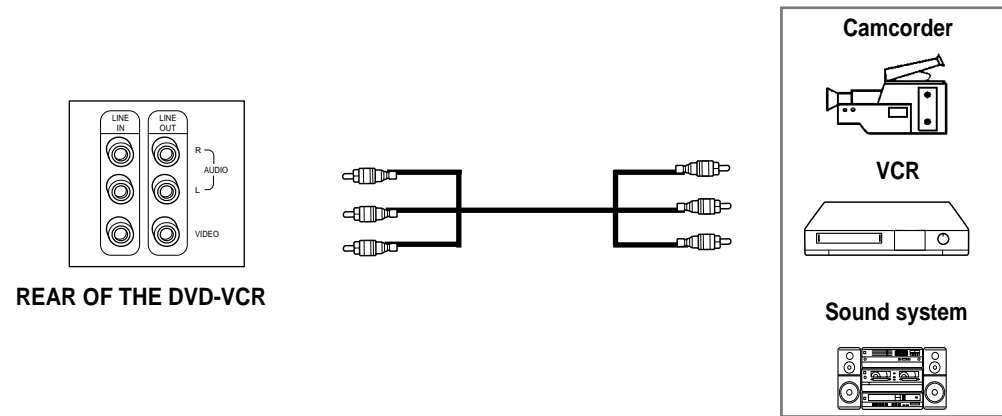

REAR OF THE DVD-VCR

Plug & Auto Set up

Your DVD-VCR will automatically set itself up when it is plugged into the mains for the first time. TV stations will be stored in memory. The process takes a few minutes. Your DVD-VCR will then be ready for use.

- 1 Connect the coaxial cable as indicated on page 11. (Connecting Your DVD-VCR to the TV Using the Coaxial Cable)
- 2 Plug the DVD-VCR into the mains.
Result: The **Language Set** menu is displayed.
- 3 Select the required language by pressing the ▲ or ▼ buttons.
- 4 Press OK to store the language selected.
Result: A message appears.
- 5 Press OK to start the auto scanning.
 - ◆ The number of stations automatically stored by the VCR depends on the number of stations that it has found.

- Auto preset can be performed by pressing ■ (STOP) on the VCR continuously for 5 seconds or more with no tape inserted.

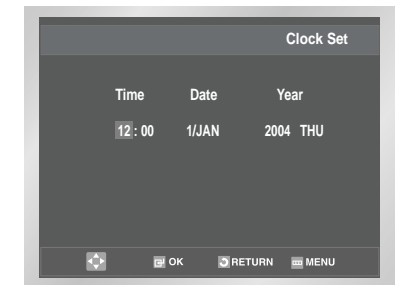
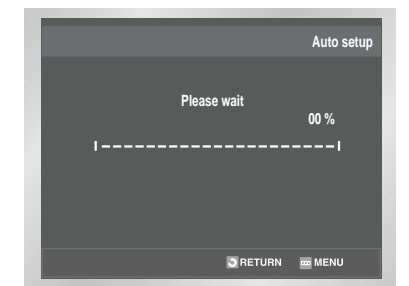
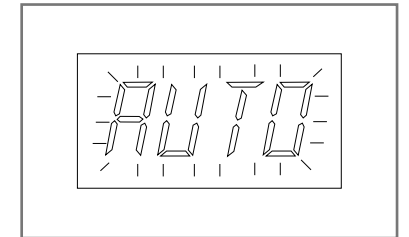
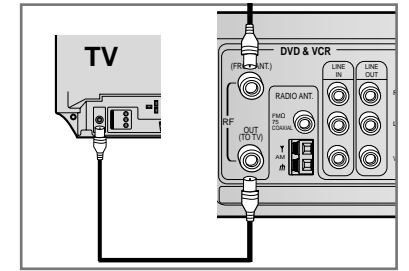

Tuning Your Television for the DVD-VCR

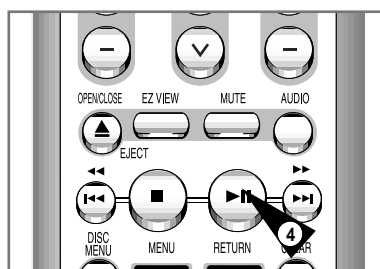
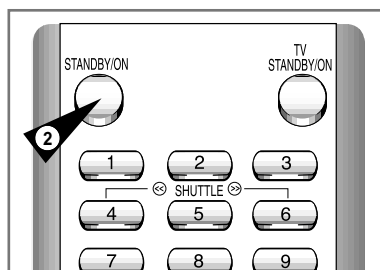

You must tune your television for the DVD-VCR only if you are not using a RCA cable

➤ To view pictures from your DVD-VCR when a RCA cable is used, the television must be set to the audio/video mode (AV).

- 1 Switch on the television.
- 2 Switch on the DVD-VCR by pressing STANDBY/ON on the front of the DVD-VCR or STANDBY/ON on the remote control.
- 3 Select a programme position on the television to be reserved for use with your DVD-VCR.
- 4 Insert the video cassette in the DVD-VCR. Check that the DVD-VCR starts reading the cassette; if not, press ►|| button.
- 5 Start a scan on your television or set the television to UHF channel 36.
- 6 Fine tune the television until the pictures and sound are obtained clearly.
- 7 If you cannot find the pictures and sound, or there is interference from nearby channels, it may be necessary to change the setting of the DVD-VCR output channel (see Setting the DVD-VCR Output Channel on page 23 and Problems and Solutions on page 73).
- 8 When the picture and sound are perfectly clear, store this channel at the desired programme position on the television.
Result: That programme is now reserved for use with your DVD-VCR.

Deck Control Keys

The DVD-VCR uses one set of controls to operate both decks. The following keys are helpful in successfully controlling each deck.

- 1 **STANDBY/ON Button**
Press the STANDBY/ON button on the remote control or front panel to turn on the DVD-VCR.
- 2 **DVD Button**
Press the DVD button on the remote control when you want to control the DVD deck.
◆ The DVD indicator will light on the Front Panel Display to show that the DVD deck is selected.
- 3 **VCR Button**
Press the VCR button on remote control when you want to control the VCR deck.
◆ The VCR indicator will light on the Front Panel Display to show that VHS deck is selected.
- 4 **INPUT SEL. BUTTON**
Press the INPUT SEL. button repeatedly to cycle through all of your input sources, including the Tuner (PR##), Line (rear AV input).
• Input select is only available when the VCR deck is selected.

➤ **Before using the VCR operation of 19~44 pages, press the VCR button on the remote control to select VCR mode.**

Before using the DVD operation of 45~65 pages, press the DVD button on the remote control to select and watch DVD.

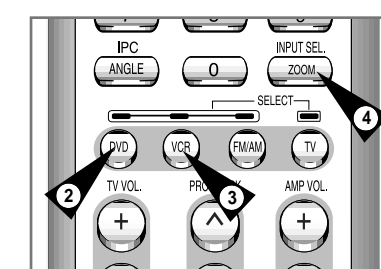
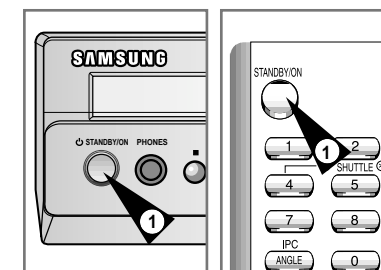

Basic TV Tuner Operations

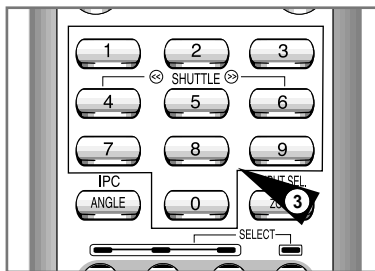
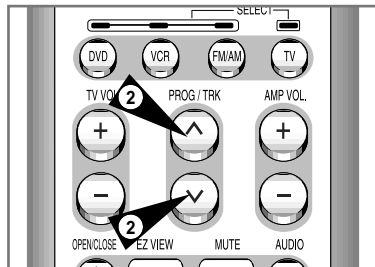
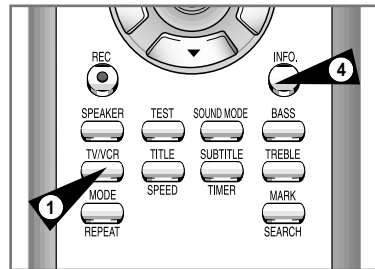

The following buttons are used when watching television via the DVD-VCR's built-in TV tuner.

- 1 TV/VCR Button**
Press to switch between your TV's tuner and the VCR's internal tuner.
- 2 PROG \wedge/\vee Button**
Press to change to the next or previous channel.
- 3 0-9 Buttons**
Press to select channels directly.
- 4 INFO.**
Press to display the channel you are watching.
◆ Also works in DVD and VCR mode.

Copying from DVD to VCR

The DVD-VCR allows you to copy the contents of a DVD to a VHS tape with a press of the COPY button.



If the DVD you are attempting to copy is copy protected, you will not be able to copy the disc. It is not permitted to copy Macrovision® encoded DVDs.

- 1 INSERT DISC**
Insert the disc you wish to copy in the DVD deck and close the drawer.
- 2 Insert VHS Tape**
Insert a blank VHS videotape into the VCR deck.
- 3 Copy the DVD to VHS Tape**
Press the COPY button on the DVD-VCR front panel.
◆ The DVD will go into Play mode and the VCR will go into Record mode.
◆ If the DVD disc menu appears, you may need to press the PLAY button manually to begin copying.
- 4 Stop the Copy Process**
When the DVD is finished playing, press the VCR button on the remote control and then press the STOP button to end the copy.
◆ You must stop the Copy process manually when the DVD movie ends or the DVD may replay and record over and over again.



The copy is only active PAL Disc system.

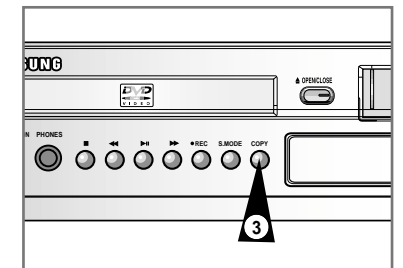
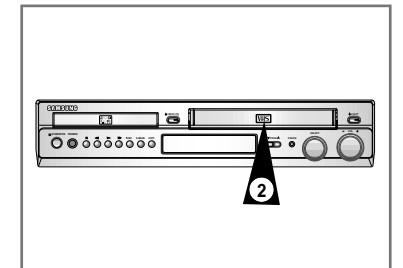
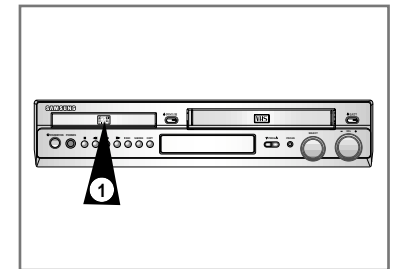

Inserting Batteries in the Remote Control

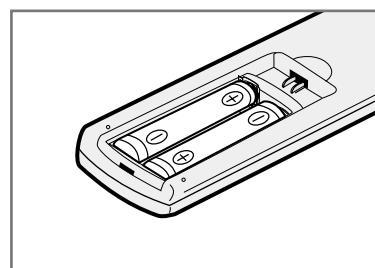
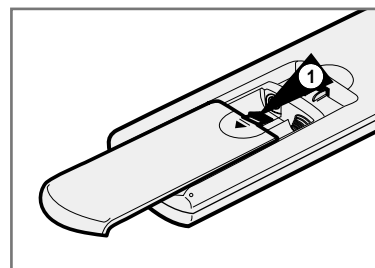

You must insert or replace the batteries in the remote control when you:

- ◆ Purchase the DVD-VCR
- ◆ Find that the remote control is no longer working correctly

- 1** Push the tab in the direction of the arrow to release the battery compartment cover on the rear of the remote control.
- 2** Insert two AAA, RO3 or equivalent batteries, taking care to respect the polarities:
 - ◆ + on the battery with + on the remote control
 - ◆ - on the battery with - on the remote control
- 3** Replace the cover by aligning it with the base of the remote control and pushing it back into place.



Do not mix different battery types (manganese and alkaline for example).

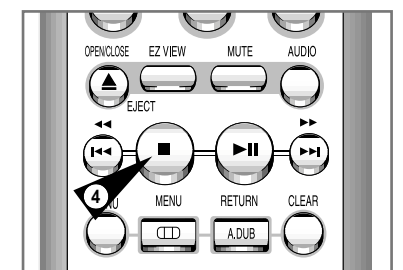
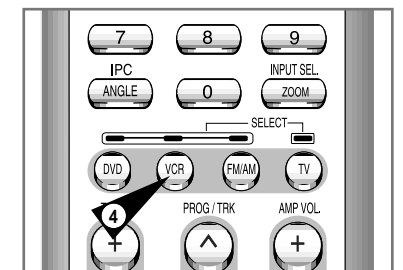

Setting the Date and Time

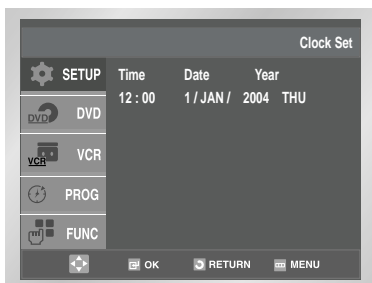

Your DVD-VCR contains a 24-hour clock and calendar used to:

- ◆ Automatically stop programme recording
- ◆ Preset your DVD-VCR to record a programme automatically

You must set the date and time when:

- ◆ You purchase the DVD-VCR

◆ Do not forget to reset the time when you change clocks from winter to summer time and vice versa.

- 1 After pressing the MENU, press the OK or ►.
Result: The Setup menu is displayed.
- 2 Press the corresponding ▲, ▼ buttons to select the **CLock** option.
- 3 Press the OK or ► to select this option.
Result: The **CLock Set** menu is displayed.
- 4 Press ◀ or ▶ to select the hour, minutes, day, month and year.
Result: The option selected highlight.
- 5 Press the ▲ or ▼ buttons to increase or decrease the value.
Result: The day of the week is displayed automatically.
➤ You can hold the ▲ or ▼ buttons down to scroll more quickly through the values.
- 6 Press the ▲ or ▼ to select On/Off, if you select Auto Clock.
Result: The selected On/Off is displayed.
- 7 On completion, press RETURN three times to exit the menu.

Setting the Menu Language

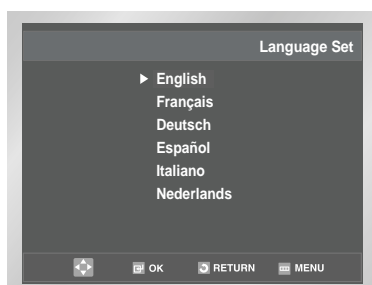
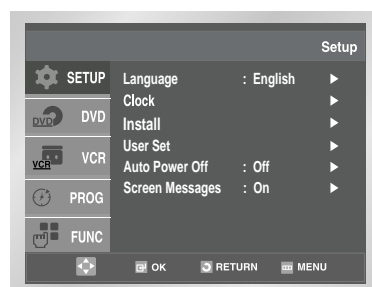

- 1 **Open "MENU"**
After pressing the MENU, press the OK or ►.
- 2 **Select "Language"**
Use the ▲ or ▼ buttons to highlight "Language," then press the OK or ►.
- 3 **Set menu Language**
Place the selection arrow next to your desired Language, then press the OK button.
- 4 On completion, press RETURN twice to exit the menu.

Presetting the Stations Automatically

VCR

✎ You do not need to preset the stations if you have already set them automatically (see Plug & Auto Set Up on page 13).

Your DVD-VCR contains a built-in tuner used to receive television broadcasts.

You must preset the stations received through the tuner. This can be done:

- ◆ Plug & Auto Set up (see page 13)
- ◆ Automatically
- ◆ Manually (see page 20)

You can store up to 80 stations.

- 1 After pressing the MENU, press the OK or ►.
Result: The Setup menu is displayed.
- 2 Press the corresponding ▲, ▼ buttons to select the **Install** option.
- 3 Press the OK or ► to select this option.
Result: The **Install** menu is displayed.
- 4 Press the corresponding ▲ or ▼ buttons, until the **Auto Setup** is selected. And then press the OK or ► to select this option.
Result: A message appears, indicating that any channels already preset on your VCR will be deleted.
- 5 Press OK to start the auto scanning.
Result:
 - ◆ The **Please Wait** indication highlight on the television screen.
 - ◆ The first frequency band is scanned and the first station found is displayed and stored.
 - ◆ The DVD-VCR then searches for the second station and so on.
 - ◆ When the automatic scanning procedure has finished, the DVD-VCR switches automatically to programme 1.
 ➤ The number of stations automatically stored by the DVD-VCR depends on the number of stations that it has found.
- 6 If you wish to cancel the auto scanning before the end, press the MENU button to exit the menu.

➤ ◆ Once the auto scanning procedure has finished, some stations may have been stored more than once; select the stations with the best reception and delete the ones no longer required (see page 21).

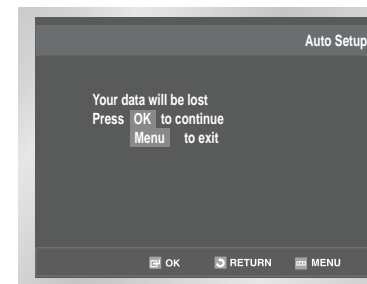
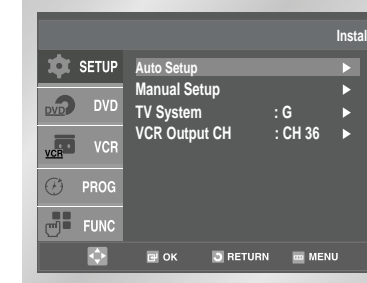
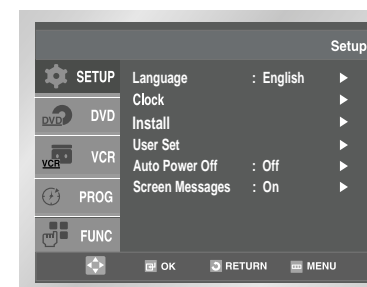

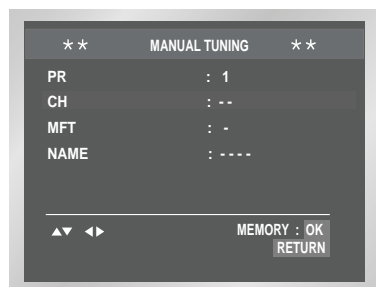
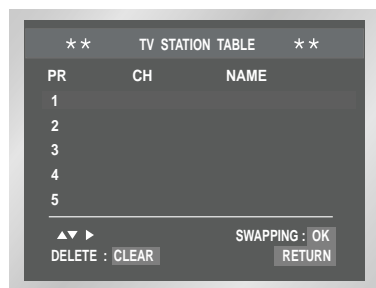
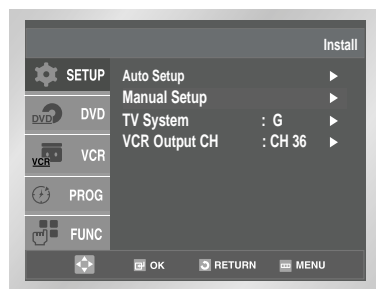

You do not need to preset the stations manually if you have already set them automatically.

- 1 After pressing the MENU, press the OK or ►.
Result: The Setup menu is displayed.
- 2 Press the corresponding ▲, ▼ buttons to select the **Install** option.
- 3 Press the OK or ► to select this option.
Result: The **Install** menu is displayed.
- 4 Press the corresponding ▲ or ▼ buttons, until the **Manual Setup** option is selected.
- 5 Press the OK or ► to select a **Manual Setup** option.
Result: The **TV STATION TABLE** menu is displayed.
- 6 Press the ▲ or ▼ buttons to select a programme number as required.
- 7 Press the ► button to preset the station.
Result: The **MANUAL TUNING** menu is displayed.
- 8 Press the ◀ or ▶ buttons to start scanning channel.
Result: The frequency band is scanned and the first station found is displayed.
- 9 Press the ▲ or ▼ buttons until the **NAME** is selected.
The station name is set automatically from the broadcast signal.
- 10 To change the programme's name, press the ► button.
Result: The first letter of the name flashes.
- 11

To...	Then...
Select a character in the name	Press the ▲ or ▼ button until the required character is displayed (letters, numbers or "-" character).
Move to the next or previous character	Press the ◀ or ▶ buttons respectively.
- 12

If you...	Then...
Wish to store the station displayed	<ul style="list-style-type: none"> ◆ Press the ▲ or ▼ buttons until the MFT is selected. ◆ Press the ◀ or ▶ buttons to adjust the picture, if necessary. ◆ Press OK to store the station
Do <u>not</u> wish to store the station displayed	<ul style="list-style-type: none"> ◆ Press the ▲ or ▼ buttons until the CH is selected. ◆ Press the ◀ or ▶ buttons to go on scanning the frequency band and display the next station ◆ Go back to the beginning of Step 9
- 13 Repeat this procedure from Step 9 onwards, until all the required stations have been stored.
- 14 On completion, press the RETURN button three times to exit the menu.

If you have stored a TV station:

- ◆ *That you do not require*
- ◆ *At the wrong programme position*

you can cancel it.

- 1 After pressing the MENU, press the OK or ►.
Result: The Setup menu is displayed.
- 2 Press the corresponding ▲, ▼ buttons to select the **Install** option.
- 3 Press the OK or ► to select this option.
Result: The **Install** menu is displayed.
- 4 Press the corresponding ▲ or ▼ buttons, until the **Manual Setup** option is selected.
- 5 Press the OK or ► to select a **Manual Setup** option.
Result: The **TV STATION TABLE** menu is displayed.
- 6 Press the corresponding ▲ or ▼ buttons, until the required preset TV station (PR) is selected.
- 7 Press the CLEAR button.
- 8 Repeat the same procedure from Step 6 onwards until all the required stations have been cleared.
- 9 On completion, press the RETURN button four times to exit the menu.

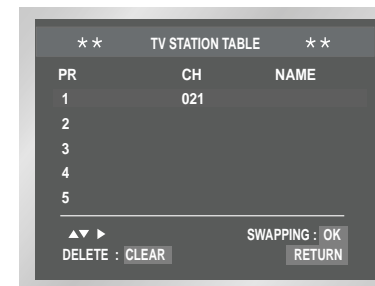

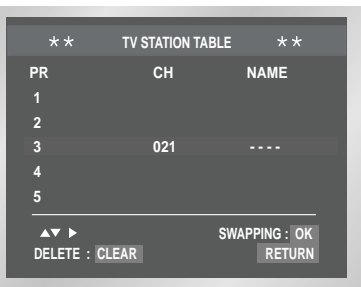
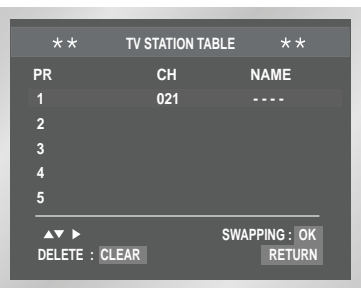
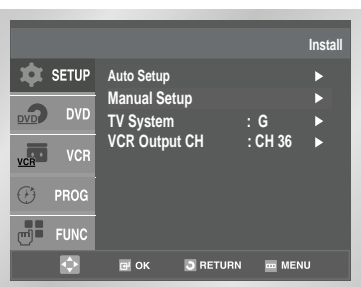
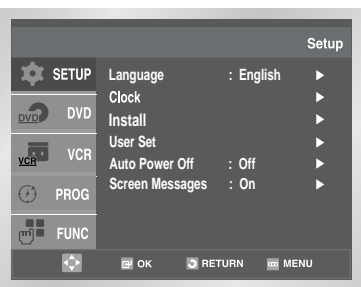

You can rearrange the Station Table and give different programme numbers to the stations listed according to your own preferences.

- 1 After pressing the MENU, press the OK or ►.
Result: The Setup menu is displayed.
- 2 Press the corresponding ▲, ▼ buttons to select the **Install** option.
- 3 Press the OK or ► buttons to select this option.
Result: The **Install** menu is displayed.
- 4 Press the corresponding ▲ or ▼ buttons, until the **Manual Setup** option is selected.
- 5 Press the OK or ► button to select this option.
Result: The **TV STATION TABLE** menu is displayed.
- 6 Press the corresponding ▲ or ▼ buttons, until the required preset TV programme is selected.
Result: The selected station is displayed at the same time on the television screen.
- 7 To change the programme number assigned to a station press the OK button on the remote control. (For example, To move a TV station in programme 1 to programme 3)
- 8 Press the ▲ or ▼ buttons to select required position. And then press OK again to swap the position.
- 9 On completion, press the RETURN button four times to exit the menu.

You can choose the sound mode (B/G or D/K) according to the TV set connected to your VCR.

- 1 After pressing the MENU, press the OK or ►.
Result: The Setup menu is displayed.
- 2 Press the corresponding ▲, ▼ buttons to select the **Install** option.
- 3 Press the OK button to select this option.
Result: The **Install** menu is displayed.
- 4 Press the ▲ or ▼ buttons, until the **TV System** option is selected.
- 5 Press the OK or ► button to select G or K.
- 6 On completion, press RETURN three times to exit the menu.

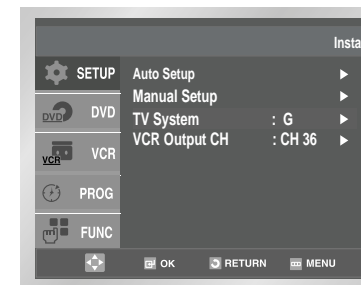

Your DVD-VCR output channel may need to be changed if the pictures suffer from interference or if your TV cannot find the pictures.

Also, you can change the DVD-VCR output channel to adjust the frequency in which information is displayed on the screen.

- 1 After pressing the MENU, press the OK or ►.
Result: The Setup menu is displayed.
- 2 Press the corresponding ▲, ▼ buttons to select the **Install** option.
- 3 Press the OK or ► to select this option.
Result: The **Install** menu is displayed.
- 4 Press the ▲ or ▼ buttons, until the **VCR Output CH** option is selected.
- 5 Select the required output channel (CH21~CH69) by pressing the OK or ► buttons.
- 6 On completion, press RETURN three times to exit the menu. Then tune your television again (see page 14).

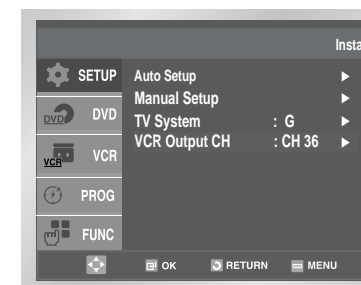
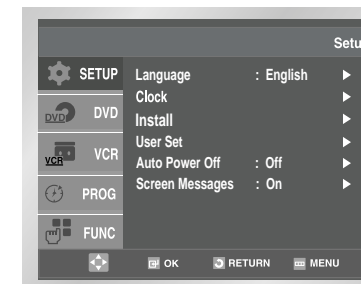

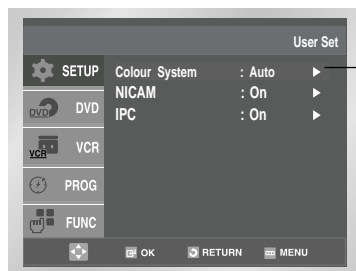
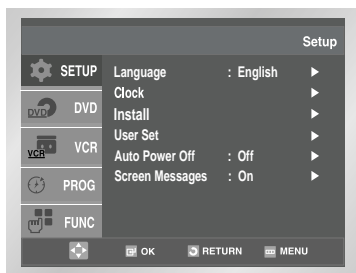

Auto
PAL
MESECAM
B/W

Before recording or playing back a cassette, you can select the required system standard.

➤ ◆ When you playback an NTSC-recorded tape on this DVD-VCR make a setting on the colour system according to your TV. If your TV is a PAL system only TV, set NTPB. If your TV is Multi System TV (NTSC 4.43 compatible), set NT4.43 and you can record NT4.43.

- 1 After pressing the MENU, press the OK or ►.
Result: The Setup menu is displayed.
- 2 Press the corresponding ▲, ▼ buttons to select the **User Set** option.
- 3 Press the OK or ► to select this option.
Result: The **User Set** menu is displayed.
- 4 Press the corresponding ▲ or ▼ buttons, until the **Colour System** option is selected.
- 5 Press the Ok or ► button to select **Auto** → **PAL** → **MESECAM** → **B/W**.

B/W	Black and White
------------	-----------------
- 6 On completion, press RETURN three time to exit the menu.

NICAM programmes are divided into 3 types. **NICAM Stereo, NICAM Mono and Bilingual (transmission in another language).** **NICAM programmes are always accompanied by a standard mono sound broadcast and you can select the desired sound.** Please refer to page 38.

- 1 After pressing the MENU, press the OK or ►.
Result: The Setup menu is displayed.
- 2 Press the corresponding ▲, ▼ buttons to select the **User Set** option.
- 3 Press the OK or ► to select this option.
Result: The **User Set** menu is displayed.
- 4 Press the corresponding ▲ or ▼ buttons, until the **NICAM** option is selected.
- 5

To...	Press OK or ►, until...
Mono mode	Off is displayed. Off: Only set at this position to record the standard mono sound during a NICAM broadcast if the stereo sound is distorted due to inferior reception conditions.
NICAM mode	On is displayed. On: Normally set at this position.
- 6 On completion, press RETURN three times to exit the menu.

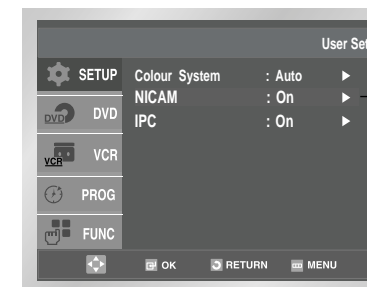
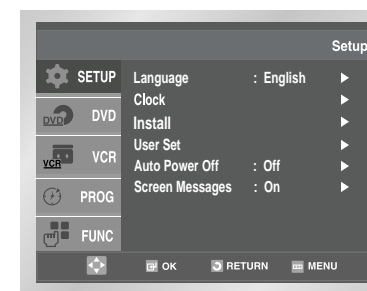

On
Off

VCR Intelligent Picture Control

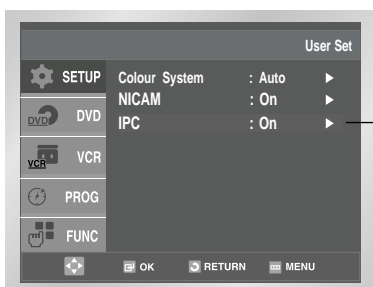

The **Intelligent Picture Control Feature** allows you to adjust the sharpness of the image automatically, according to your own preferences.

- 1 During playback, press the MENU button on the remote control.
Result: The Setup menu is displayed.
- 2 Press the OK or ► button.
Result: The Setup menu is displayed.
- 3 Press the corresponding ▲, ▼ buttons to select the **User Set** option.
- 4 Press the OK or ► buttons to select this option.
Result: The **User Set** menu is displayed.
- 5 Press the corresponding ▲ or ▼ buttons, until the **IPC** option is selected.
- 6 Press the OK or ► button to select IPC (Intelligent Picture Control) option.
➤ When intelligent picture control mode is **ON**, the sharpness of the image is adjusted automatically.
- 7 To adjust the sharpness manually, press the ▼ button to turn the IPC mode **OFF**.
- 8 Press the ◀ or ▶ buttons until the picture is displayed according to your preferences.
➤ If you do not press a button within ten seconds, the **PICTURE** menu disappears automatically.
- 9 On completion, press the RETURN button.

➤ You can also directly Select function using IPC button on the remote control.

Auto Power Off

The **Auto Power Off** feature automatically turns off your DVD-VCR if no signal is received and you do not press any button for the selected time.

- 1 After pressing the MENU, press the OK or ►.
Result: The Setup menu is displayed.
- 2 Press the corresponding ▲ or ▼ buttons, until the **Auto Power Off** option is selected.
- 3 Press the OK or ► buttons, until you select the time of Auto Power Off interval.

Off → 1Hour → 2Hour → 3Hour
- 4 On completion, press RETURN twice to exit the menu.

VCR

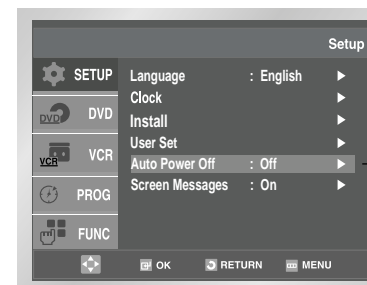
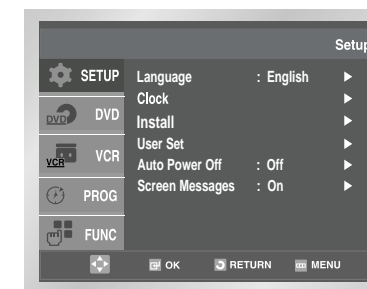

Off
1Hour
2Hour
3Hour

VCR Intelligent Picture Control (Remote Control)

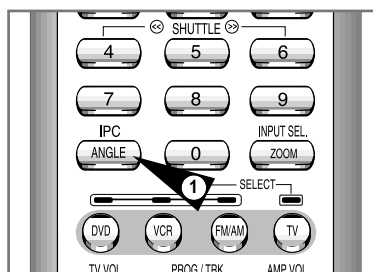

- 1 During playback, press the IPC button.
Result: The **PICTURE** menu is displayed.
- 2 Press the ▼ button to turn the IPC (Intelligent Picture Control) option **ON** and **OFF**.
➤ When Intelligent Picture Control mode is **ON**, the sharpness of the image is adjusted automatically.
- 3 To adjust the sharpness manually, select Intelligent Picture Control mode **OFF**.
◆ The horizontal picture adjusting appears.
- 4 Press the ◀ or ▶ buttons until the picture is displayed according to your preferences.
➤ If you do not press a button within ten seconds, the **PICTURE** menu disappears automatically.
- 5 On completion, press the IPC button again.

VCR Screen Messages

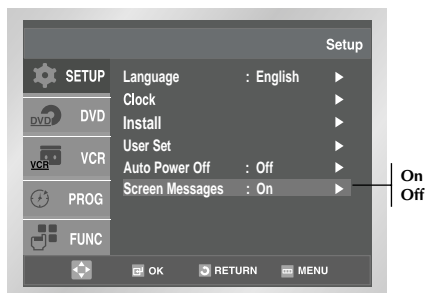

Your DVD-VCR displays most information on both the DVD-VCR and the television.

You can choose to display or hide this information on the television screen (except for the *SEARCH*, *Programming MENU* and *Timer* functions, which cannot be hidden).

- After pressing the MENU, press the OK or ► buttons. **Result:** The Setup menu is displayed.
- Press the corresponding ▲ or ▼ buttons, until the **Screen Messages** option is selected.
- | To... | Press OK or ►, until... |
|-------------------------------|--------------------------|
| Display on-screen information | On is displayed. |
| Hide on-screen information | Off is displayed. |
- On completion, press RETURN twice to exit the menu.

Repeat Play

You can set repeat play to repeat the tape continuously from beginning to end.

- After pressing the MENU, press the corresponding ▲, ▼ buttons to select the **VCR** option.
- Press the OK or ► buttons to select this option. **Result:** The **VCR Setup** menu is displayed.
- Press the corresponding ▲ or ▼ buttons, until the **Repeat Play** option is selected.
- | To... | Press OK or ►, until... |
|----------------------------|--------------------------|
| Repeat play | On is displayed. |
| Do not wish to repeat play | Off is displayed. |
- On completion, press RETURN twice to exit the menu.

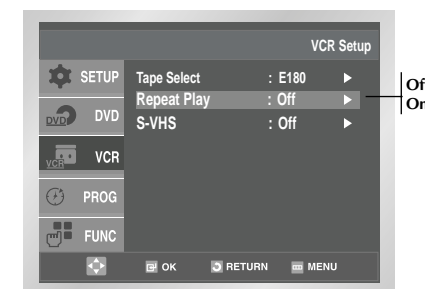
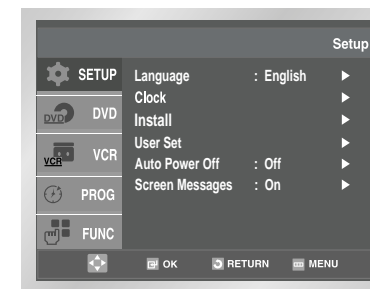

VCR Selecting the Cassette Type



If you wish to use the tape counter to display the time remaining on a cassette, you must indicate the type of cassette inserted.

- After pressing the MENU press the corresponding ▲, ▼ buttons to select the **VCR** option.
- Press the OK or ► buttons to select this option. **Result:** The **VCR Setup** menu is displayed.
- Press the corresponding ▲ or ▼ buttons, until the **Tape Select** option is selected.
- Press the OK or ► buttons as many times as required, until the correct cassette length is displayed.

→ E180	→ E240
E 300 ←	E260 ←
- Press RETURN twice to exit the menu.

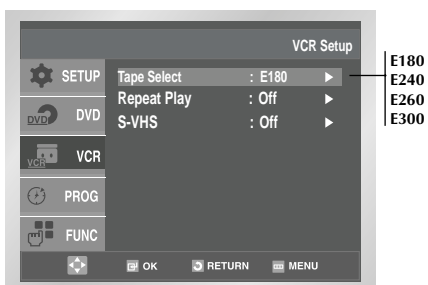

S-VHS Play

The DVD-VCR allows you to playback high quality S-VHS tapes.

- During S-VHS play mode, press the MENU.
- Press the corresponding ▲, ▼ buttons to select the **VCR** option.
- Press the OK or ► button to select this option. **Result:** The **VCR Setup** menu is displayed.
- Press the corresponding ▲ or ▼ buttons, until the **S-VHS** option is selected.
- | To... | Press OK or ►, until... |
|---------------------------|--------------------------|
| S-VHS play | On is displayed. |
| Do not wish to S-VHS play | Off is displayed. |
- On completion, press RETURN twice to exit the menu. To watch S-VHS tapes, set the S-VHS mode to **On** in the VCR Setup.

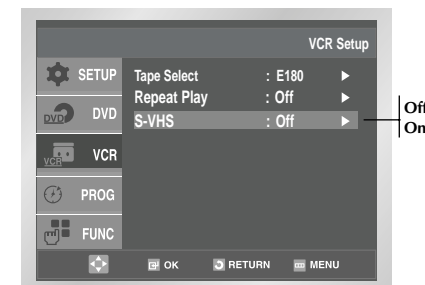
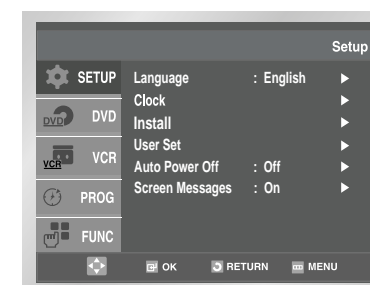

VCR Selecting the Recording Speed

Type	Recording Time (in SP)
E-180	180 mins. or 3 hours
E-240	240 mins. or 4 hours
E-260	260 mins. or 4 hours and 20 mins.
E-300	300 mins. or 5 hours

You can record a cassette at two different speeds:

- ◆ **SP (Standard Play)**
- ◆ **LP (Long Play)**

In Long Play modes:

- ◆ **Each cassette lasts twice as long**
- ◆ **The recording is of a slightly lower quality**

To record a cassette... Press the **SPEED** button on the remote control, until...

In standard play mode **SP** is displayed.
In long play mode **LP** is displayed.

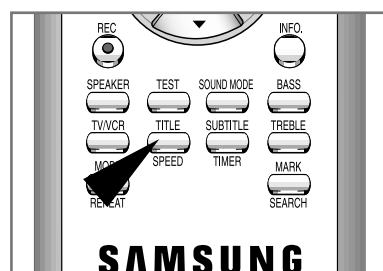

Protecting a Recorded Cassette

Video cassettes have a safety tab to prevent accidental erasure. When this tab has been removed, you cannot record on the tape.

- 1 If you wish to protect a cassette, break off the tab using a small screwdriver.
- 2 To re-record over a protected cassette (safety tab broken), cover the hole with adhesive tape.

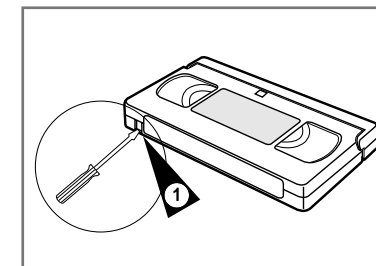

Recording a Programme Immediately

Before recording a programme, you must have preset the corresponding station (unless you are recording via an external video source). If you have not done so, refer to pages 19 and 20.

- 1 Switch on the television.
- 2 To monitor the programme being recorded, select the television channel reserved for use with your DVD-VCR (or the AV input if used).
- 3 Insert the cassette on which the programme is to be recorded, with the window visible and the safety tab intact or the opening covered with adhesive tape.
Result: The DVD-VCR is switched on automatically.
- 4 Select:
 - ◆ The station to be recorded using the PROG (▲ or ▼) buttons **or**
 - ◆ The LINE source using the INPUT SEL. button for a satellite tuner or external video source**Result:** The station number is displayed and the programme can be seen on the television.
- 5 Select the recording speed by pressing the SPEED button as many times as required (see page 30).
- 6 Hold REC (●) down for a while to start recording.
Result: The record indicator appears on the television and DVD-VCR display. An index is recorded on the tape (see page 38).
- 7 To stop recording, press ■ once.

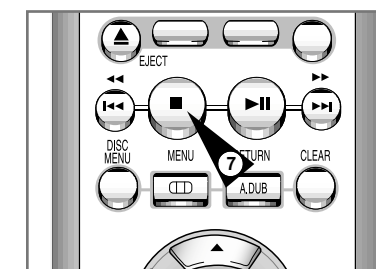
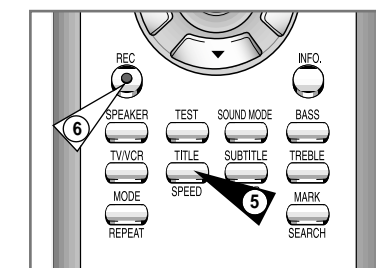
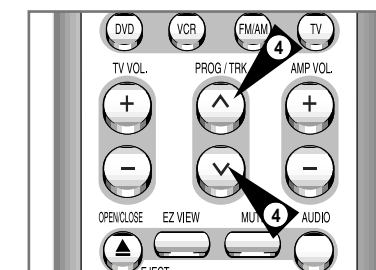

- ◆ If your DVD-VCR ejects the cassette when you start recording, check to make sure that the cassette's safety tab is intact or that the opening (created by a broken safety tab) is covered with adhesive tape.
- ◆ If you reach the end of the tape while recording, the cassette rewinds automatically.

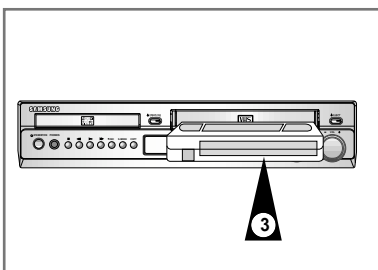

This function enables you to record up to nine hours (LP) of programmes.
Your DVD-VCR stops automatically after the requested length of time.

- 1 Switch on the television.
- 2 To monitor the programme being recorded, select the television channel reserved for use with your DVD-VCR (or the AV input if used).
- 3 Insert the cassette on which the programme is to be recorded, with the window visible and the safety tab intact or the opening covered with adhesive tape.
Result: The DVD-VCR is switched on automatically.
- 4 Select:
 - ◆ The station to be recorded using the PROG (▲ or ▼) buttons or
 - ◆ The LINE source using the INPUT SEL. button for a satellite tuner or external video source**Result:** The channel number is displayed and the programme can be seen on the television.
- 5 Select the recording speed by pressing the SPEED button as many times as required (see page 30).
- 6 Hold the REC (●) button down for a while to start recording.
Result: The record indicator appears on the television screen and DVD-VCR display. An index is recorded on the tape (see page 38).
- 7 Press the REC (●) button several times to increase the recording time in:
 - ◆ 30-minute intervals up to four hours
 - ◆ 1-hour intervals up to nine hours**Result:** The length is displayed on the television displays. The selected programme is recorded for the length of time requested. At the end of that time, the DVD-VCR stops recording automatically and power off.
- 8 If you wish to cancel the recording before the end, press STANDBY/ON.

- ☞ If the end of the tape is reached while recording:
 - ◆ The recording stops and power off.
- ☞ This function is not available in DVD recording

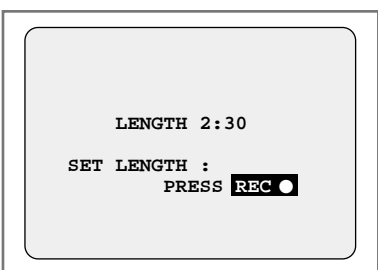
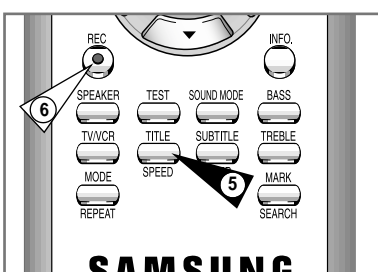
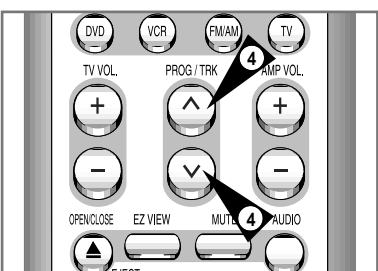

The Timer Programming feature allows you to preset the DVD-VCR to record a programme up to one month before that programme is to be broadcast. Up to six programmes can be preset.

☞ Before presetting a recording, check that the date and time are correct.

- 1 Insert the cassette and press TIMER on the remote control.
Result: The **Timer Programme** is displayed.
- 2 Press OK or ► to select the input source.
- 3 Select the required station or input source (LINE) by pressing the ▲, ▼ buttons.
- 4 Press ► to select the recording day.
- 5 Select the required day by pressing the ▲ or ▼ buttons.
- 6 Press ► to select the recording start time.
- 7 Select the required hour value by pressing the ▲ or ▼ buttons.
- 8 Press ► to select the minutes.
- 9 Select the required minute value by pressing the ▲ or ▼ buttons.
- 10 Press ► to select the recording stop time.
- 11 Select the required recording stop time by pressing the ▲ or ▼ buttons, following the same procedure as when selecting the recording start time.
- 12 Press ► to select the recording speed.
- 13 Press the ▲ or ▼ buttons to select the **SP** (Standard Play), **LP** (Long Play), **Auto** (Auto Tape Speed Select) recording speeds.
- 14 When you have finished, press the RETURN button.
- 15 Press the STANDBY/ON button to activate the timer.
Result: Before starting recording, the DVD-VCR compares the timer duration with the remaining time on the cassette.

➤ **Auto Tape Speed Select.** The DVD-VCR's "Auto Tape Speed Select" function compares the duration of the timer recording to the actual recording time remaining on the tape loaded. If there is insufficient tape to complete a timer recording in AUTO mode, the DVD-VCR automatically switches to LP mode to record the whole programme.

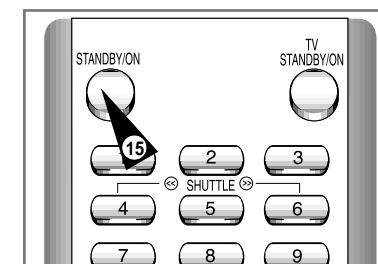
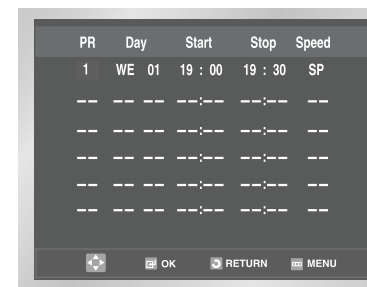

VCR Checking a Preset Recording

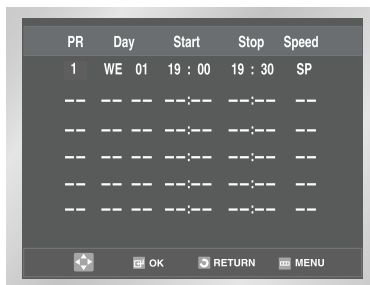

You can check your preset recordings:

- ◆ When you have finished presetting the DVD-VCR
- ◆ If you have forgotten which programmes will be recorded

- 1 Press TIMER on the remote control.
Result: The **Timer Programme** is displayed.
- 2 Press the ▲ or ▼ buttons to select the required programme.
- 3 Press the ▲, ▼ or ◀, ▶ buttons to select and change any values as required. For more details, refer to the previous page.
- 4 On completion, press RETURN three times.

Playing a Cassette

VCR

This function allows you to play back any pre-recorded cassette.

- 1 Switch on both the television and your DVD-VCR.
- 2 Insert the video cassette to be played. If the safety tab on the cassette is intact, press ►II. Otherwise, the cassette is played automatically.
 - When a cassette is loaded, the tape position is optimized automatically to reduce disturbance (Digital Auto Tracking). When playing a cassette, if the end of the tape is reached, the cassette is rewound automatically.
- 3

To...	Then press...
Stop the playback	■ (STOP).
Eject the cassette	▲ (EJECT).

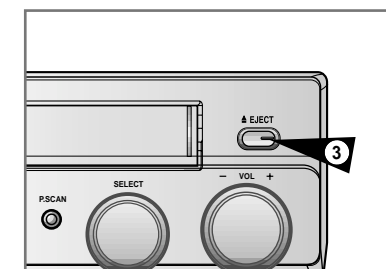
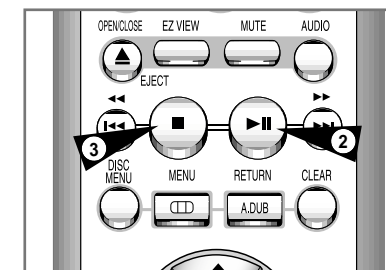

VCR Cancelling a Preset Recording

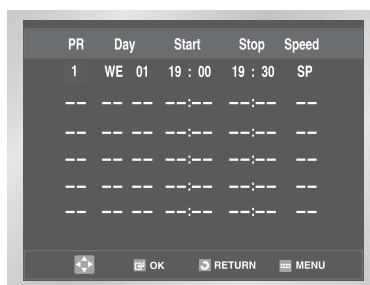

You can cancel any programmes that are:

- ◆ Incorrect
- ◆ No longer required

- 1 Press TIMER on the remote control.
Result: The **Timer Programme** is displayed.
- 2 Select the programme to be cancelled by pressing the ▲ or ▼ buttons.
- 3 Press the CLEAR button to cancel the selected programme.
Result: All the recording information is deleted and the broadcast will not be recorded.
- 4 On completion, press RETURN three times.

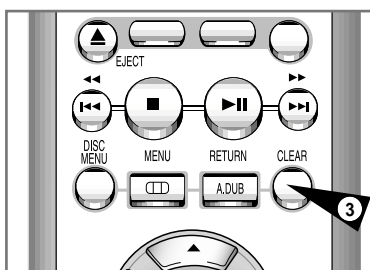

Adjusting Picture Alignment Manually

VCR

The Picture Adjustment feature allows you to adjust the alignment manually to obtain the best possible picture.

When noise bars or streaks appear during playback, adjust alignment manually by pressing the TRK (▲ or ▼) buttons until the picture is clear and stable.

- Result:
- ◆ The tracking bar appears.
 - ◆ The image is adjusted.
 - ◆ The tracking bar disappears when you release the button.

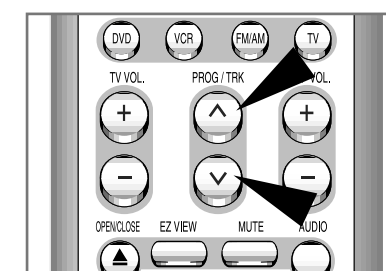

VCR Selecting the Audio Output Mode

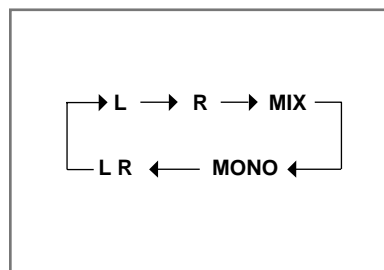
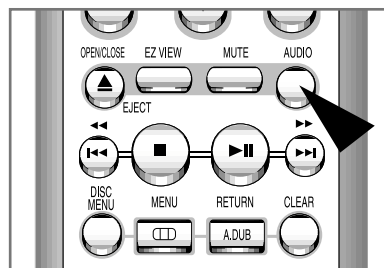

You can select the mode in which the sound is reproduced on the loudspeakers and AV outputs. The following options are available.

Option	Description
L	Used to listen to the sound on the left Hi-Fi channel.
R	Used to listen to the sound on the right Hi-Fi channel.
MIX	Used to listen to the mixed sound of the Hi-Fi and normal channels.
MONO	Used to listen to the sound on the normal mono channel.
L R	Used to listen to Hi-Fi stereo sound on the left and right channels. ➤ When playing back tapes recorded in Hi-Fi, the sound switches to Hi-Fi after five seconds of Mono.

To select the sound mode, simply press the AUDIO button on the remote control until the required option is displayed.

Playing a Sequence at Variable Speeds

You can vary the playback speed using the Shuttle function (up to nine times the normal speed).

Example: You wish to analyze a sportsperson's technique, movement by movement.

The Shuttle function is available on the Remote control

➤ No sound is heard when playing a sequence at variable speeds.

- Press:
 - ◆ ▶|| during playback
 - ◆ SHUTTLE (<<) to play the cassette backwards
 - ◆ SHUTTLE (>>) to play the cassette forwards
- Each time you press a SHUTTLE button, the speed is changed as shown in the following illustration.

REVERSE PLAY X9	REVERSE PLAY X5	REVERSE PLAY X3	STILL	SLOW MOTION X1/10	SLOW MOTION X1/5	PLAY X3	PLAY X5	PLAY X9
-----------------------	-----------------------	-----------------------	-------	-------------------------	------------------------	------------	------------	------------

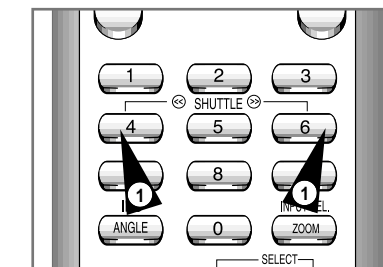

VCR Playing a Cassette in Slow Motion

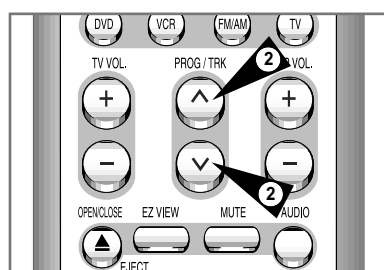
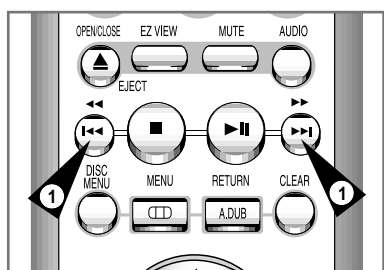

You can play a cassette in slow motion.

➤ No sound is heard when playing back a cassette in slow motion.

- Press:
 - ◆ ▶|| to start playing the cassette
 - ◆ ▶|| button one more time to make still mode.
 - ◆ >> to start SLOW mode.
 - ◆ << or >> button as many times as required to decrease or increase the speed respectively
 - ◆ To return to the normal speed, press the ▶|| button twice.
- When playing back in slow motion, picture interference may occur. Press the TRK (∧ or ∨) buttons to minimize this effect.

☞ When you have been using the Slow Motion function for more than about two minutes, the DVD-VCR will automatically play to protect the:

- ◆ Cassette
- ◆ Video heads

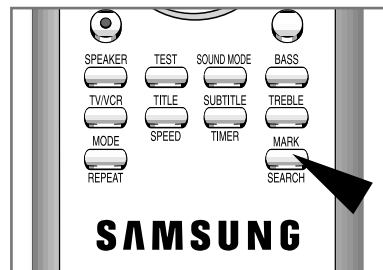

Each time you record a cassette on this DVD-VCR, an “index” is automatically marked on the tape when recording starts.

The Search function allows you to fast-forward or rewind to a specific index and start playback from that point. Depending on the direction selected, the indexes are numbered as follows:

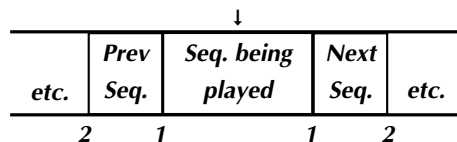

➤ This DVD-VCR uses a standard indexing system (VISS). As a result, it will recognize any indexes marked by other VCRs using the same system and vice versa.

Go To [0:00:00] Stop

Use this feature when you want to search for the [0:00:00] counter position on a cassette. Press the CLEAR button at the point on the tape where you want to set the counter to [0:00:00].

The VCR will rewind or fast forward, searching for the [0:00:00] counter position, and then automatically stop at that position.

- 1 After pressing the SEARCH, press the corresponding ▲ or ▼ buttons, until the Go To [0:00:00] option is selected.
- 2 Press the OK or ►.

End Search

Use this feature when you want to search for a blank position to record a program on a cassette.

The VCR will fast forward, searching for a blank position, and then automatically stop at that position. If the VCR reaches the end of the tape during end search, the tape will be ejected.

- 1 After pressing the SEARCH, press the corresponding ▲ or ▼ buttons, until the End Search option is selected.
- 2 Press the OK or ►.

Intro Scan

- 1 After pressing the SEARCH, press the corresponding ▲ or ▼ buttons, until the Intro Scan option is selected.
- 2 Press the OK or ►.
- 3 Press the ◀◀ or ▶▶ buttons depending on the direction where your desired programme is located.
- 4 When an Index mark is found the DVD-VCR will playback the tape for 5 seconds, after which it will continue searching for the next Index mark.
- 5 If you want to watch the tape from a particular Index, simply press ►|| twice.

Index Skip Search:

This feature will enable you to fast forward/rewind to a specific point on a tape: E.g. if you have recorded 3 different programmes on a tape and you have rewound the tape to the beginning, by using this feature you can go directly to the start of programme 2 simply by pressing the SEARCH button.

- 1 After pressing the SEARCH, press the corresponding ▲ or ▼ buttons, until the Intro Scan option is selected.
- 2 Press the OK or ►.
- 3 Press the ◀◀ or ▶▶ buttons twice more. This will take you directly to the start of the desired programme is located.
- 4 These Index searches can be made forwards: (press ▶▶) or backwards: (press ◀◀). (◀◀-20 . . 0 . . +20 ▶▶)
- 5 To cancel an Index search simply press the ►|| or ■ button.

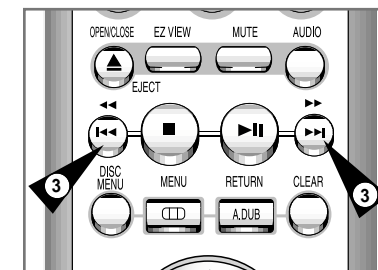
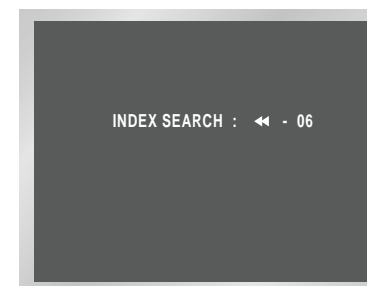
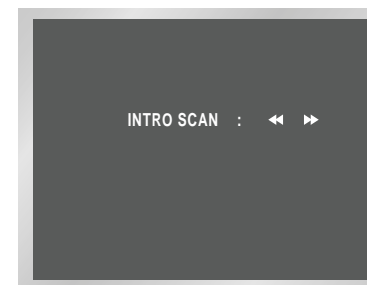
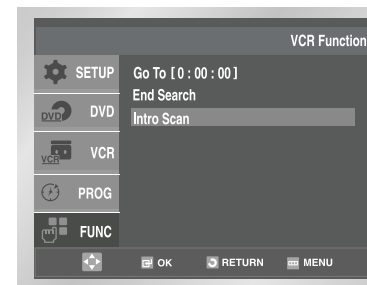

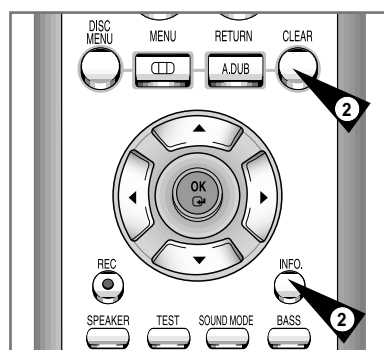
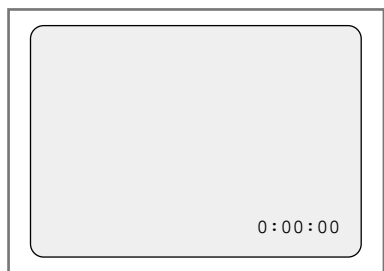

The tape counter:

- ◆ Indicates the elapsed time in the play and record modes (hours, minutes and seconds)
- ◆ Is reset when a cassette is inserted in the DVD-VCR
- ◆ Allows you to find the beginning of a sequence easily

☞ If the remaining time is to be calculated correctly, you must indicate the type of cassette being used.

- 1 Insert a cassette in your DVD-VCR.

- 2 To set the tape counter to zero at the beginning of a sequence:
 - ◆ Press INFO. twice to display the counter
 - ◆ Press CLEAR when you want to set the tape counter to zero

- 3 When you are ready,
 - ◆ Start playback or Recording.
 - ◆ Press the ■ button.
 - ◆ To fast-forward or rewind to the sequence at which the counter was set to zero, press ◀◀ or ▶▶.

➤ Some DVD-VCR information, such as the counter, can be displayed on the television screen (unless you have deactivated the Screen messages mode; refer to page 28).

Press INFO.:

- ◆ Once to display the current function, programme number, recording speed, date, time and counter
- ◆ Twice to display the counter only
- ◆ Three times to display the time remaining on the cassette
- ◆ Four times to clear the display

You can connect other audio/video equipment to your DVD-VCR using audio/video cables if the appropriate outputs are available on the equipment chosen.

- Examples:**
- ◆ You wish to copy a video cassette with the help of a second VCR .
 - ◆ You wish to play back and/or copy pictures taken with a camcorder .

☞ Make sure that both the television and the DVD-VCR are switched off before connecting the cables.

- 1 Connect one end of the RCA video cable into the VIDEO INPUT socket on the rear of the DVD-VCR.

- 2 Plug the other end of the video cable into the appropriate output connector on the other system (VCR or camcorder).

- 3 Connect one end of the RCA audio cable supplied into the AUDIO INPUT sockets on the rear of the DVD-VCR.
 - Take care to respect the colour coding of the left and right channels.

- 4 Plug the other end of the audio cable into the appropriate output connectors on the other system (VCR, camcorder or Hi-Fi sound system).

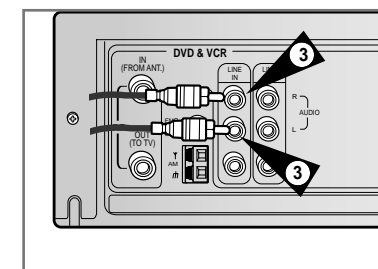
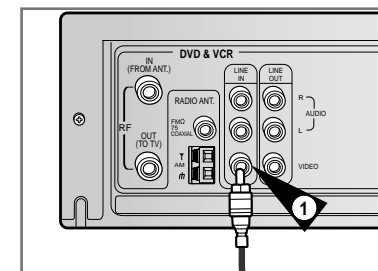

You can copy a cassette to your DVD-VCR from another video source, such as another VCR or a camcorder.

It is an infringement of copyright laws to copy prerecorded cassettes or to re-record them in any form without the permission of the owners of the corresponding copyright.

- 1 Connect the DVD-VCR, from which the cassette is to be copied, to the appropriate RCA audio and video input connectors on the rear of your DVD-VCR, as indicated on page 12.
- 2 Insert a blank cassette in your DVD-VCR.
- 3 Insert the pre-recorded cassette in the other video source (VCR or camcorder).
- 4 Press the INPUT SEL. button to select the appropriate input on your DVD-VCR: LINE IN for the RCA input.
- 5 Start playing back the cassette to be copied.
- 6 Hold REC (●) down for a while to start recording on your DVD-VCR.
- 7 When you have finished recording, press ■ on both VCR and DVD-VCR.

If you wish to view the cassette being copied:

- ◆ Your DVD-VCR must be connected as usual to the television (see page 11 for further details)

With the Audio Dubbing function, you erase the previously recorded sound and replace it with a new soundtrack from:

- ◆ A CD, DVD
- ◆ A microphone connected to a sound system
- ◆ A cassette player

Restriction:

Audio dubbing is applicable only to the longitudinal audio track (normal audio).

- 1 Connect an RCA audio cable to the appropriate output on your sound system (cassette player for example).
- 2 Connect the other end of the RCA audio cable to the audio input connectors (L, R) on the rear of your DVD-VCR.
- 3 Insert the pre-recorded cassette on which the audio track is to be replaced, and press the ►► to start playback.
- 4 Search for the Audio Dubbing (ending) point using the ►►, and set the counter to 0:00:00 by pressing INFO. and CLEAR.
- 5 Search back slightly beyond the Audio Dubbing start point using the ◀◀ button.
- 6 Press the ►► button.
Press the ►► button one more time to make Still mode.
- 7 Press A.DUB.
Result: Your DVD-VCR is now in the Audio dubbing Still mode.
- 8 On the sound system, locate the point on the cassette at which you wish to start playback.
Example: The track that you wish to record on the cassette.
- 9 When you are ready:
 - ◆ Start playback on the sound system
 - ◆ Press the REC (●) on the remote control.**Result:** The soundtrack is replaced on the pre-recorded cassette.
- 10 The audio dubbing will finish when the counter reaches 0:00:00.

The new sound will be recorded on the normal sound track of the tape, and the original sound will remain on the Hi-Fi sound track. To hear the new sound and original sound mixed together, press the Audio button on the remote control until the MIX option is displayed (see page 36).

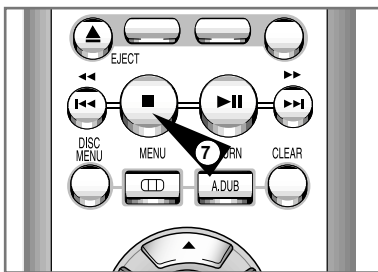
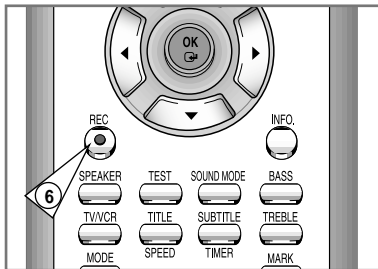
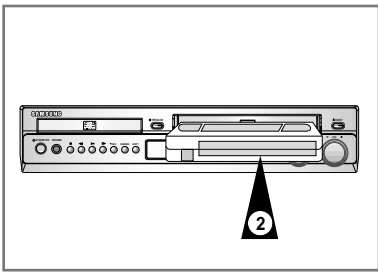
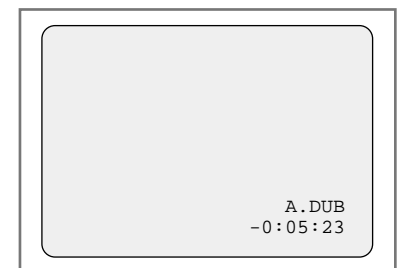
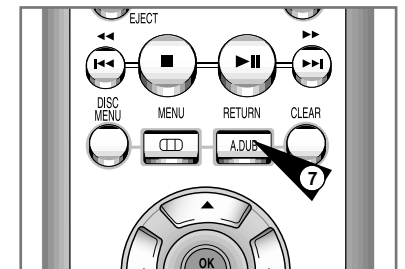
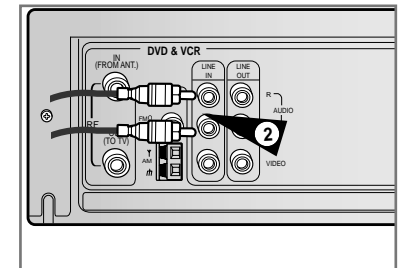
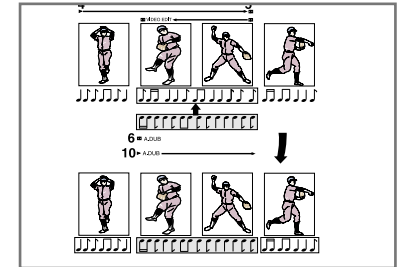

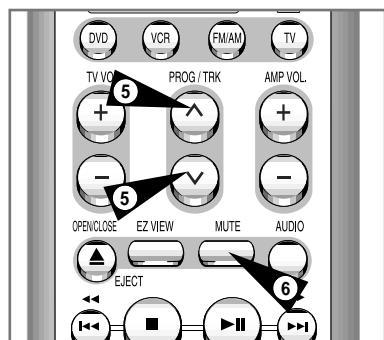
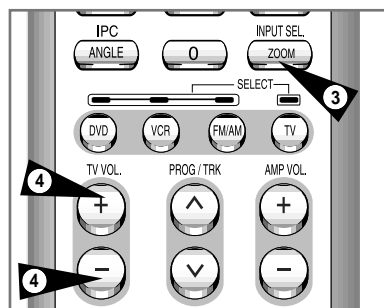
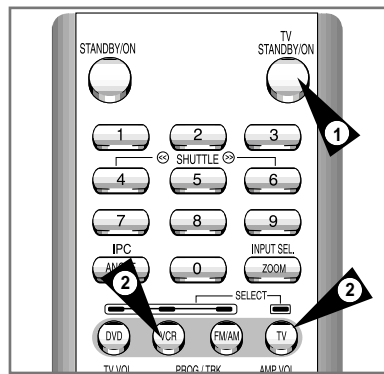

Your DVD-VCR remote control will work with Samsung televisions and compatible brands.

To determine whether your television is compatible, follow the instructions below.

- 1 Switch your television on.
- 2 Point the remote control towards the television.
- 3 Hold down the TV button and enter the two-figure code corresponding to the brand of your television, by pressing the appropriate numeric buttons.

Brand	Codes	Brand	Codes
SAMSUNG	01 to 06	PHILIPS	02, 20, 22
AKAI	09, 23	SABA	13, 14, 22 to 24
GRUNDIG	09, 17, 21	SONY	15, 16
LOEWE	02	THOMSON	13, 14, 24
PANASONIC	08, 23 to 27	TOSHIBA	07, 16 to 19, 21

Result: If your television is compatible with the remote control, it will switch off. It is now programmed to operate with the remote control.

➤ If several codes are indicated for your television brand, try each one in turn until you find one that works.

👉 When you change the batteries in the remote control, you must reprogramme the code, following the same procedure.

You can then control the television using the following buttons.

Button	Function
TV STANDBY/ON ①	Used to switch the television on and off.
TV or VCR ②	Used to switch between the TV and VCR modes.
INPUT SEL. ③	Used to select an external source.
VOL + or - ④	Used to adjust the volume of the television.
PROG/TRK ⑤ (^ or v)	Used to select the required programme.
TV MUTE ⑥	Used to mute the volume of the television.

➤ The various functions will not necessarily work on all televisions. If you encounter problems, operate the television directly.

The following show examples of connections commonly used to connect the DVD -VCR player with a TV and other components. It is only available for DVD. The VCR out can not watch by this connection.

Connection to an Television

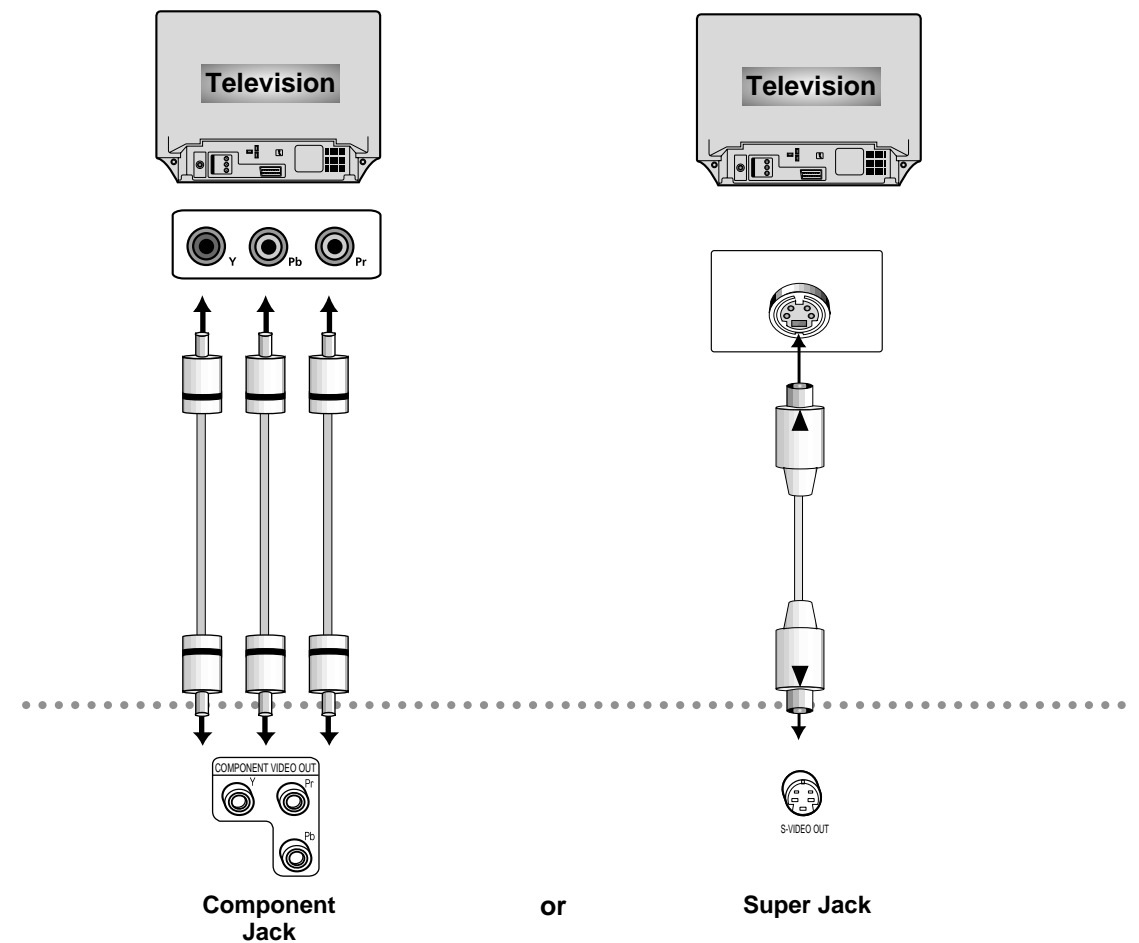

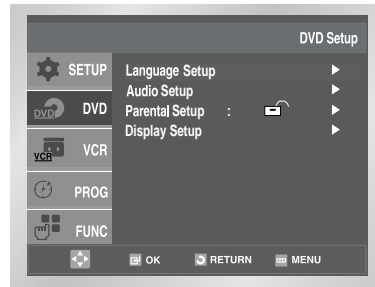

If you set the player menu, disc menu, audio and subtitle language in advance, they will come up automatically every time you watch a movie.

Using the Disc Menu Language

This function changes the text language only on the disc menu screens.

- 1 With the unit in Stop mode, press the MENU button.
- 2 Select **DVD** using ▲, ▼ buttons, then OK or ► button.
- 3 Select **Language Setup** using ▲, ▼ buttons, then press the OK or ► button.
- 4 Select **Disc Menu** using ▲, ▼ buttons, then press the OK or ► button.
- 5 Use the ▲, ▼ buttons to select '**English**'.
- Select "Others" if the language you want is not listed.
- 6 Press the OK button.
- English is selected and the screen returns to Language Setup.

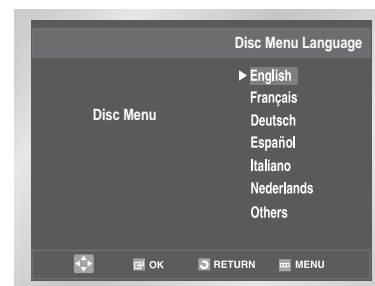
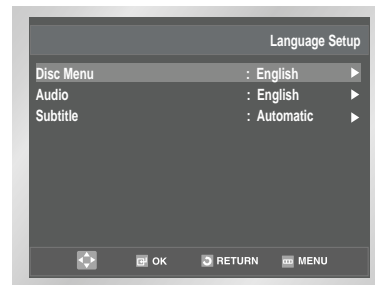

Using the Audio Language

- 1 With the unit in Stop mode, press the MENU button.
- 2 Select **DVD** using ▲, ▼ buttons, then OK or ► button.
- 3 Select **Language Setup** using ▲, ▼ buttons, then press the OK or ► button.
- 4 Select **Audio** using ▲, ▼ buttons, then press the OK or ► button.
- 5 Press the ▲, ▼ buttons to select '**English**'.
- Select "Original" if you want the default soundtrack language to be the original language the disc is recorded in.
- Select "Others" if the language you want is not listed.
- 6 Press the OK button.
- English is selected and the screen returns to Language Setup.

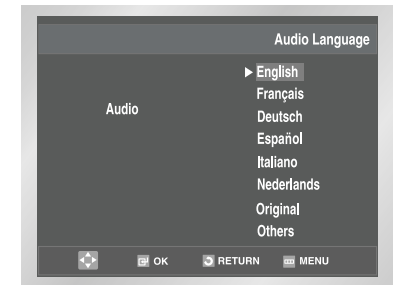
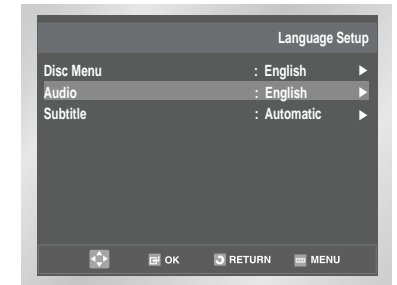

Using the Subtitle Language

- 1 With the unit in Stop mode, press the MENU button.
- 2 Select **DVD** using ▲, ▼ buttons, then OK or ► button.
- 3 Select **Language Setup** using ▲, ▼ buttons, then press the OK or ► button.
- 4 Select **Subtitle** using ▲, ▼ buttons, then press the OK or ► button.
- 5 Use the ▲, ▼ buttons to select '**English**'.
- Select "Automatic" if you want the subtitle language to be the same as the language selected as the audio preference.
- Select "Others" if the language you want is not listed.
Some discs may not contain the language you select as your initial language; in that case the disc will use its original language setting.
- 6 Press the OK button.
- English is selected and the screen returns to Language Setup.

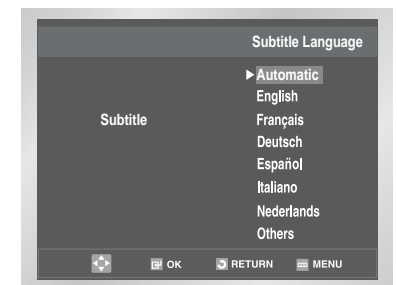
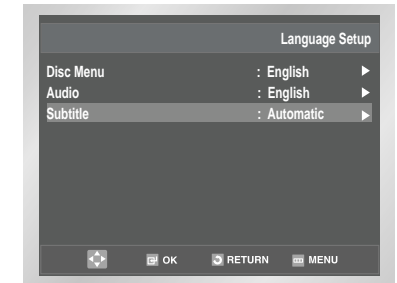

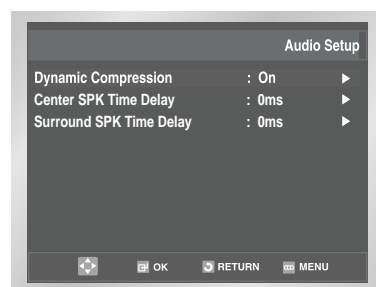
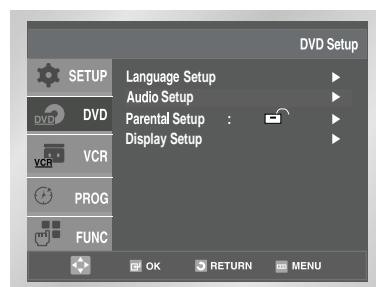

- 1 With the unit in Stop mode, press the MENU button.
- 2 Select **DVD** using ▲, ▼ buttons, then OK or ► button.
- 3 Select **Audio Setup** using ▲, ▼ buttons, then press the OK or ► button.
- 4 Use the ▲, ▼ buttons to select the desired item. Then press the OK or ► button.
 - ◆ Dynamic Compression
 - On : To select dynamic compression.
 - Off : To select the standard range.
 - ◆ Center SPK Time Delay (See Page 66)
 - ◆ Surround SPK Time Delay (See Page 66)

➤ **How to make the SETUP menu disappear or return to menu screen during set up; Press RETURN or ◀ button.**

The Parental Control function works in conjunction with DVDs that have been assigned a rating - which helps you control the types of DVDs that your family watches. There are up to 8 rating levels on a disc.

- 1 With the unit in Stop mode, press the MENU button.
- 2 Select **DVD** using ▲, ▼ buttons, then OK or ► button.
- 3 Select **Parental Setup** using ▲, ▼ buttons, then press the OK or ► button.
- 4 Use OK or ► to select **Yes** if you want to use a password. The **Enter Password** screen appears.
- 5 Enter your password. The **Re-Enter Password** screen appears to confirm the password. ENTER your password again. The Parental Setup screen appears.

◆ **About the Rating Level ;**

The Rating Level will work only when **Use Password** is set to Yes. To unlock the player, OK or ► to select No. Use ▲, ▼ to select **Rating Level**. Press OK

- Use ▲, ▼ to select the level(e.g. Level 6) and press OK. Discs that contain Level 7 will now not play.
- To cancel the rating level, use OK or ► to select No in Use Password.

◆ **About the Change Password ;**

- Use ▲, ▼ to select Change Password. Press OK. The Change Password screen appears.
- ENTER your new password. Re-ENTER the new password again.

-
- **How to make the SETUP menu disappear or return to menu screen during set up; Press RETURN or ◀ button.**
 - **If you have forgotten your password, see Forget Password in the Troubleshooting Guide. (See page 74)**

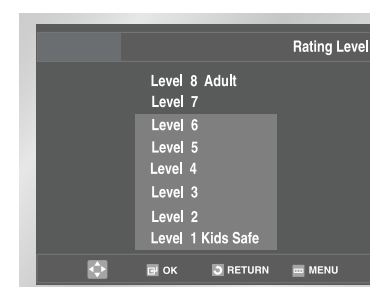
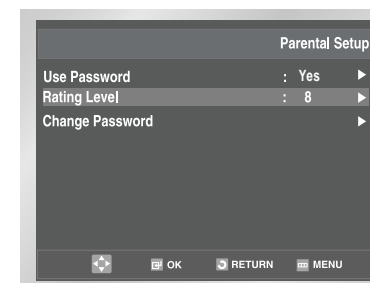
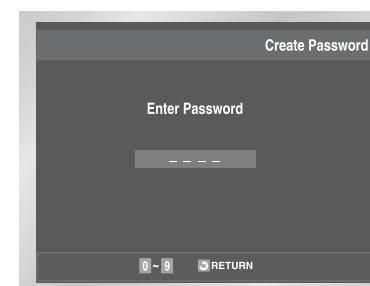
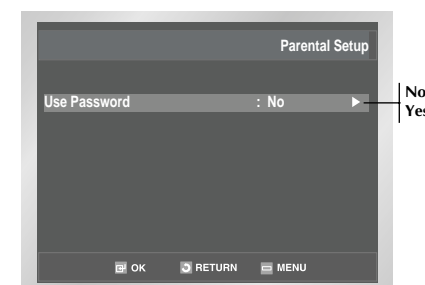

DVD Setting Up the Display Options

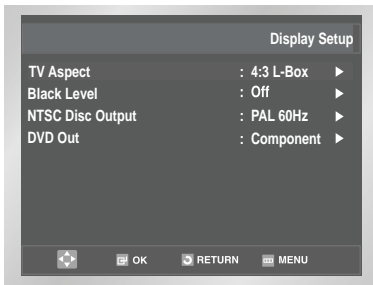
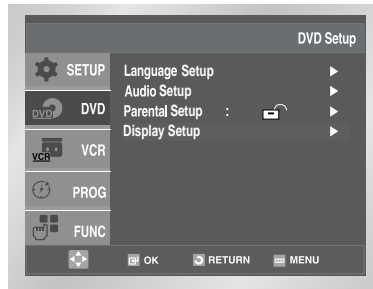

- 1 With the unit in Stop mode, press the MENU button.
- 2 Select DVD using ▲, ▼ buttons, then OK or ► button.
- 3 Select **Display Setup** using ▲, ▼ buttons, then press the OK or ► button.
- 4 Use the ▲, ▼ buttons to select the desired item. Then press the OK or ► button.

◆ TV Aspect

Depending on the type of television you have, you may want to adjust the screen setting (aspect ratio).

1. 4:3 Letter Box :

Select when you want to see the total 16:9 ratio screen DVD supplies, even though you have a TV with a 4:3 ratio screen. Black bars will appear at the top and bottom of the screen.

2. 4:3 Pan Scan :

Select this for conventional size TVs when you want to see the central portion of the 16:9 screen. (Extreme left and right side of movie picture will be cut off.)

3. 16:9 Wide :

You can view the full 16:9 picture on your widescreen TV.

◆ Black Level

Adjusts the brightness of the screen.(On/Off)

◆ NTSC Disc Output

"NTSC" if the screen only has one NTSC-video entrance. If this is not the case, you can choose to leave " PAL 60Hz" as is.

◆ DVD Output

Component : Sends COMPONENT signal (Y, Pb, Pr) to the component video out JACK.

S-Video : Sends S-VIDEO signal to the S-VIDEO OUT JACK.

Video : - Sends COMPOSITE VIDEO signal to Line out JACK.
- Sends COMPONENT INTERLACE signal from COMPONENT JACK.

Component Connections (for DVD)

DVD

Component video output is available only for DVD playback. RF and Line input are available for Tuner and VCR playback. If your TV set supports Progressive Scan, it can transmit Pr, Pb, and Y signals separately, so you can enjoy sharp and clear picture.



What is Progressive Scan?

It is a set of jacks that can provide sharp and clear picture quality by using twice the number of fields of lines than component output.

- 1 Connect the component output of the DVD player to your TV set. Use the component cable to connect the component output on the back panel of the DVD-VCR to the component input of your TV.
 - ◆ If you mix up the connections when connecting the component cable, the picture will appear reddish or bluish.
- 2 Set your TV to COMPONENT. Select component input as your TV's AV input. At this point, even if the picture appears reddish, it is normal.
- 3 Press the P.SCAN button on the front panel. If the P.SCAN button on the front panel of the DVD-VCR is pressed, a green LED will light up and the following message will be displayed:
To activate Progressive Scan, press OK.
The following message will be displayed and then the picture will be played in Progressive Scan mode.
- 4 To deactivate Progressive Scan, press the P.SCAN button again. If the P.SCAN button on the front panel of the DVD-VCR is pressed again, a green LED will light up and Progressive Scan mode will be canceled. Select another mode as your TV's AV input to view another output of the DVD-VCR.



This is available only for a TV set that supports Progressive Scan.

- While Progressive Scan is active, video, S-video are not available.
- To activate Progressive Scan, the DVD-VCR must be in Stop mode.



You can listen to audio sound through Line OUT audio output or 5.1CH speakers while watching Component or S-Video output.

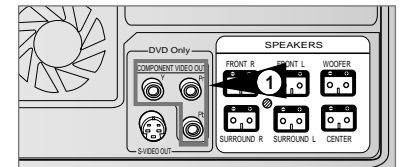

To Component Input on Your TV

Press "OK" to confirm Progressive scan mode. Otherwise press "RETURN".

Please set your TV to component input. If your TV doesn't have Progressive scan mode, there will be no signal on the screen.

DVD S-Video Connections (for DVD)

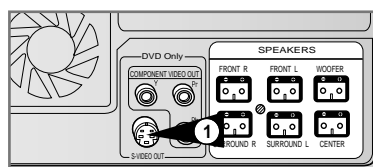

To S-Video Input on Your TV

The S-Video is only for the DVD player. The tuner and VCR will still be viewed through the RF or line inputs. You must follow the "DVD Out" instructions above to activate your alternative (S-Video) video selection. If your television is equipped with S-Video input, you can enjoy superior video quality when watching DVDs with your DVD-VCR.

1 Connect S-Video Out to TV

Connect an S-Video cable from the S-Video Out on the back panel of the DVD-VCR to the S-Video Input on your television.

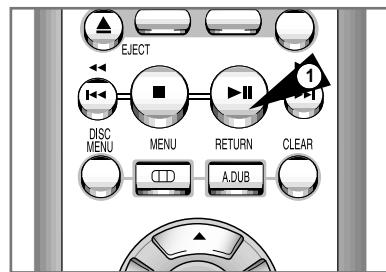

During DVD/CD playback you can select from the following special playback options. To resume normal playback, press the ►|| (Play/Still) button.

1 Still

Press the ►|| button on the remote control during playback.

- ◆ The picture will still and the audio will mute.
- ◆ To resume playback, press the ►|| button.
- ◆ If the player is left in Still mode for 5 minutes, it will stop automatically.

2 Skip Forward/Back

While a CD or DVD disc is in Play mode, press the Skip Forward/Back (►►/◄◄) buttons on the remote control or front panel to jump forward and backward through disc chapters/tracks.

- ◆ Skip Forward will jump to the next chapter/track.
- ◆ Skip Back will jump to the beginning of the current chapter/track.
- ◆ Press Skip Back again to jump to the beginning of the previous chapter/track.

Search Forward/Back

While a disc is in Play mode, press and hold the Forward/Back (►/◄) buttons on the remote control or front panel to visually search forward/backward at 2X - 4X - 8X - 16X - 32X - 128X speed. Press ►|| button to resume normal speed.

NOTE : CD search speed -2X, 4X, 8X

3 Slow Motion

During playback, press the ►|| button to Still the image. Then use the Search Forward (►) to play in slow motion at variable speeds.

- ◆ Each press increases the slow motion speed playback to 1/8, 1/4 or 1/2 normal speed.
- ◆ Audio is muted during slow motion playback.
- ◆ Slow function operates only in the forward direction
- ◆ Slow function is not available for CD

4 Stop/Resume

- ◆ Press the Stop button once to stop playback. To resume the DVD/CD from the point where the disc stopped, press the ►|| button.
- ◆ Press the ■ button twice to completely stop playback. The next time you press ►||, the disc will start over from the beginning.

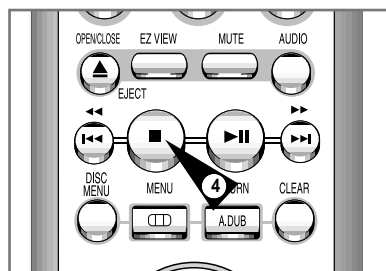
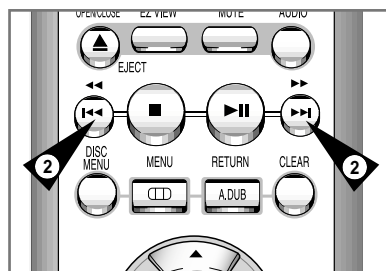

To play back using aspect ratio (DVD)

1 Press the EZ VIEW button.

- The screen size changes when the button is pressed repeatedly.
- The screen zoom mode operates differently depending on the screen setting in the initial DVD menu.
- To ensure correct operation of the EZ VIEW button, you should set the correct aspect ratio in the initial setup (See page 48).

If you are using a 16:9 TV

For 16:9 aspect ratio discs

- **Wide Screen**
Displays the content of the DVD title in 16:9 aspect ratio.
- **Screen Fit**
The top and bottom of the screen are cut off. When playing a 2.35:1 aspect ratio disc, the black bars at the top and bottom of the screen will disappear. The picture will look vertically stretched. (Depending on the type of disc, the black bars may not disappear completely.)
- **Zoom Fit**
The top, bottom, left and right of the screen are cut off and the central portion of the screen is enlarged.

For 4:3 aspect ratio discs

- **Normal Wide**
Displays the content of the DVD title in 16:9 aspect ratio. The picture will look horizontally stretched.
- **Screen Fit**
The top and bottom of the screen are cut off and the full screen appears. The picture will look vertically stretched.
- **Zoom Fit**
The top, bottom, left and right of the screen are cut off and the central portion of the screen is enlarged.
- **Vertical Fit**
When a 4:3 DVD is viewed on a 16:9 TV, black bars will appear at the left and right of the screen in order to prevent the picture from looking horizontally stretched.

If you are using a 4:3 TV

For 16:9 aspect ratio discs

• 4:3 Letter Box

Displays the content of the DVD title in 16:9 aspect ratio. The black bars will appear at the top and bottom of the screen.

• 4:3 Pan Scan

The left and right of the screen are cut off and displays the central portion of the 16:9 screen.

• Screen Fit

The top and bottom of the screen are cut off and the full screen appears. The picture will look vertically stretched.

• Zoom Fit

When a 4:3 DVD is viewed on a 16:9 TV, black bars will appear at the left and right of the screen in order to prevent the picture from looking horizontally stretched.

For 4:3 aspect ratio discs

• Normal Screen

Displays the content of the DVD title in 4:3 aspect ratio.

• Screen Fit

The top and bottom of the screen are cut off and the full screen appears. The picture would look vertically stretched.

• Zoom Fit

The top, bottom, left and right of the screen are cut off and the central portion of the screen is enlarged.

- • This function may behave differently depending on the type of disc.

When Playing a DVD

- 1 During play, press the INFO. button on the remote.
- 2 Use the ▲, ▼ buttons to select the desired item.
- 3 Use the ◀, ▶ buttons to make the desired setup.
 - You may use the number buttons of the remote control to directly access a title, chapter or to start the playback from the desired time.
- 4 To make the screen disappear, press the INFO. button again.

-
- **What is a Chapter?**
Each Title on a DVD is usually divided into chapters (similar to tracks on an audio CD).
 - **What is a Title?**
A DVD may contain several different titles. For example, if a disc contains four different movies, each might be considered a title.

TITLE To access the desired title when there is more than one in the disc. For example, if there is more than one movie on a DVD, each movie will be identified.

CHAPTER Most of DVD discs are recorded in chapters so that you can quickly find a specific passage.

TIME Allows playback of the film from a desired time. You must ok the starting time as a reference.

AUDIO Refers to the language of the film soundtrack. In the example, the soundtrack is played in English 5.1CH. A DVD disc can have up to eight different soundtracks.

SUBTITLE Refers to the subtitle languages available in the disc. You will be able to choose the subtitles language or, if you prefer, turn them off from the screen. A DVD disc can have up to 32 different subtitles.

- * When in VCD 2.0 mode (MENU ON mode), this function does not work.
- * Use the DISC MENU button in VCD 2.0 mode to select MENU ON or OFF.

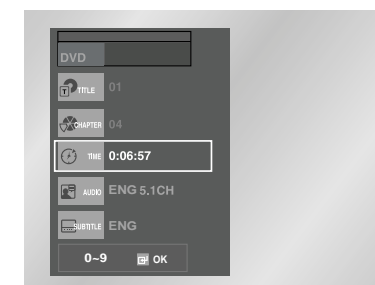
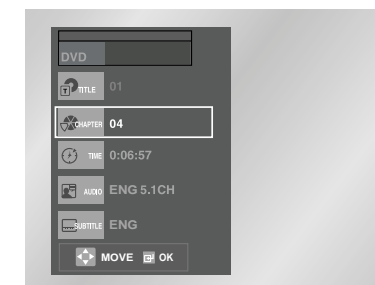
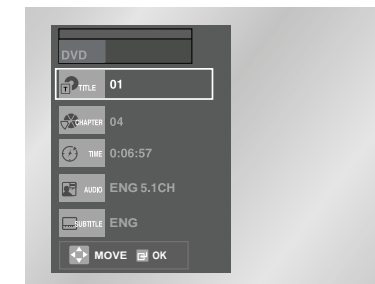
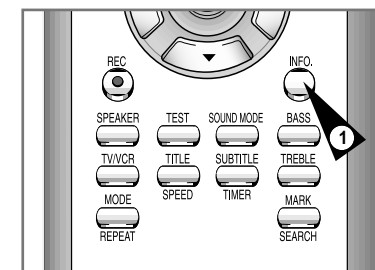

DVD Changing the Camera Angle

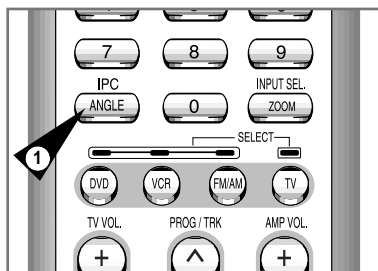

Using the ANGLE button

When a DVD contains multiple angles of a particular scene, you can select the Angle function.

Press the ANGLE button to see if an ANGLE () mark is present at the upper Right hand corner of the screen.

- 1 When an ANGLE mark is shown, press the ANGLE button, then an ANGLE select icon will appear at the upper left hand corner of the screen.
- 2 Use the ◀, ▶ buttons to select the desired screen angle.
- 3 To turn off the display, press the ANGLE button again.



DVD Selecting the Subtitle Language

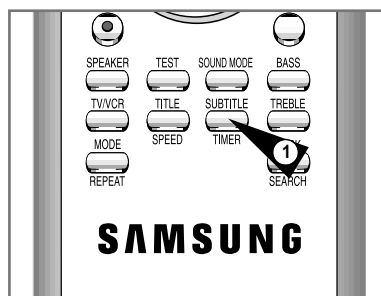

You can select a desired subtitle quickly and easily with the subtitle button.

Using the SUBTITLE button

- 1 Press the SUBTITLE button.
 - 2 Use the ◀, ▶ buttons to select the desired subtitle language.
 - 3 Use the ▲, ▼ buttons to determine whether or not the subtitle will be displayed.
 - The subtitle languages are represented by abbreviations.
-
- This function depends on what languages are encoded on the disc and may not work with all DVDs.
 - A DVD disc can contain up to 32 subtitle languages.
 - How to have the same subtitle language come up when every you play a DVD; Refer to "Setting Up the Language Features" on page 47.



Repeat Play

Repeat the current track, chapter, title, a chosen section (A-B), or all of the disc.

When playing a DVD

- 1 Press the REPEAT button on the remote. Repeat screen appears.
- 2 Select Chapter, Title or A-B using the ◀, ▶ buttons.
 - Press the REPEAT button. Select A-B on screen with the ◀, ▶ buttons.
 - Press OK at the point where you want the repeat play to start (A). The B is automatically highlighted.
 - Press OK at the point where you want the repeat play to stop (B).
 - To terminate the function, press the 'CLEAR' button.
 - A-B REPEAT does not allow you to set point (B) until at least 5 seconds has elapsed after point (A) has been set.
- 3 Press OK.
- 4 To return to normal play, press REPEAT again, then press the ◀, ▶ buttons to select Off and press OK.
 - It is available to press CLEAR button on the remote controller in order to stop REPEAT play.

-
- DVD repeats play by chapter or title, CD and VCD repeat play by disc or track.
 - Depending on the disc, the Repeat function may not work.
 - When in VCD 2.0 mode (MENU ON), this function does not work. Use the DISC MENU button in VCD 2.0 mode to select MENU ON or OFF.

Using the Zoom (DVD/VCD)

- 1 During play or still mode, press the ZOOM button on the remote. A square will be displayed on screen.
- 2 Use the ▲, ▼ or ◀, ▶ button to select the part of the screen you want to zoom in on.
- 3 Press the OK button.
 - ◆ During DVD play : press OK to zoom in 2X/4X/2X/Normal in order.
 - ◆ During VCD play, press OK to zoom in 2X/normal in order.

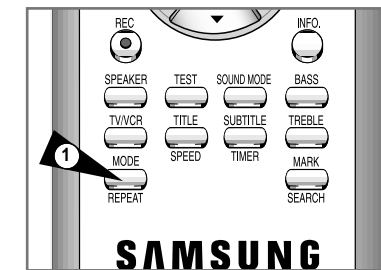

DVD

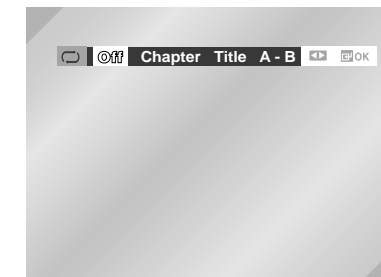

VCD/CD

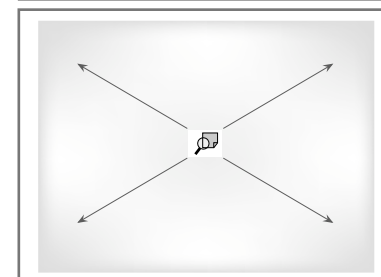
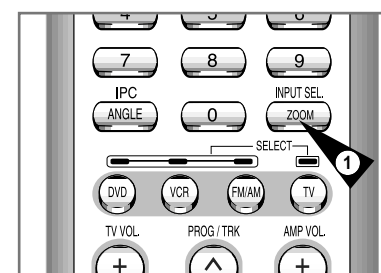
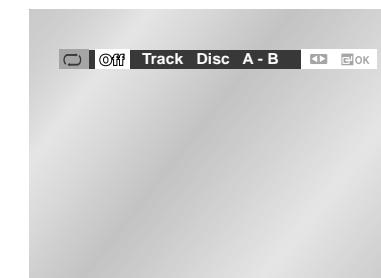

DVD Repeat Chapter/Title

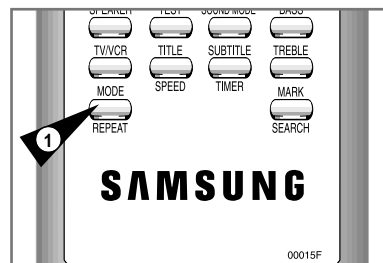

DVD



VCD/CD

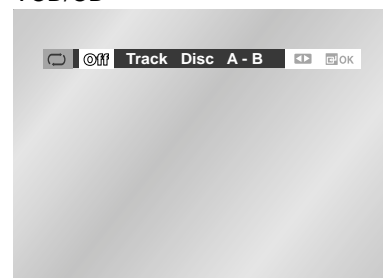

You can repeat a single chapter or a complete title.

- 1 Open Repeat Menu**
Press the REPEAT button while in Play mode to open the Repeat menu.
◆ The current Repeat mode will be highlighted.
- 2 Select "Chapter"**
Use the ◀, ▶ buttons to select "Chapter".
◆ When you select Chapter "Chapter" will be highlighted.
- 3 Repeat Chapter**
Press the OK button to repeat the current chapter.
- 4 Select "Title"**
Use the ◀, ▶ buttons to select "Title".
◆ When you select Title "Title" will be highlighted.
- 5 Repeat Title**
Press the OK button to repeat the title.
➤ DVD repeats play by chapter or title, VCD repeats play by track or disc.

Using the Mark Function (DVD/VCD)

DVD

This feature lets you mark sections of a DVD or VCD (MENU OFF mode) so you can quickly find them at a later time.

Using the Mark Function (DVD/VCD)

- 1 During play, press the MARK button on the remote. The Mark icons will be displayed.
- 2 Use the ◀, ▶ buttons to move to the desired Mark icon.
- 3 When you reach the scene you want to mark, press the OK button. The icon will change to a number (1, 2, or 3).
- 4 Press the MARK button to turn off the display.

Recalling a Marked Scene

- 1 During play, press the MARK button on the remote.
- 2 Use the ◀, ▶ buttons to select a marked scene.
- 3 Press the PLAY/STILL (▶II) buttons to skip to the marked scene.

Clearing a Mark

- 1 During play, press the MARK button on the remote.
- 2 Use the ◀, ▶ buttons to select the mark number you want to delete.
- 3 Press the CLEAR button to delete a mark number. Press the MARK button to turn off the display.

-
- Up to three scenes may be marked at a time.
 - When in VCD 2.0 mode (MENU ON), this function does not work.
 - Depending on the disc, the mark function may not work.

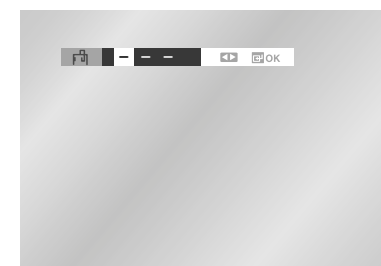
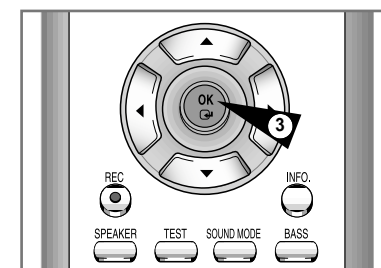

DVD Selecting the Audio Language

DVD

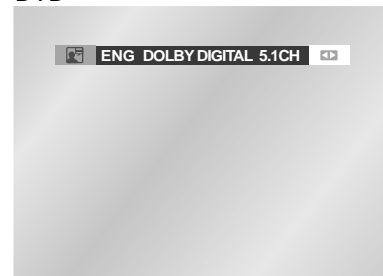

VCD/CD

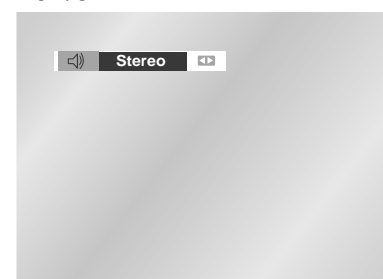

You can select a desired audio language quickly and easily with the AUDIO button.

Using the AUDIO button

- 1 Press the AUDIO button.
- 2 Use the ◀, ▶ buttons to select the desired language on a DVD.
- The audio languages are represented by abbreviations.
- 3 Use the ◀, ▶ buttons to select Stereo (On VCD/CD)

-
- This function depends on what languages are encoded on the disc and may not work with all DVDs.
 - A DVD disc can contain up to 8 audio languages.
 - How to have the same audio language come up whenever you play a DVD; Refer to "Setting Up the Language Features" on page 47.

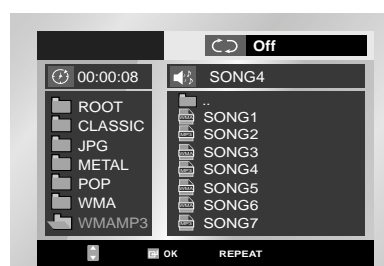
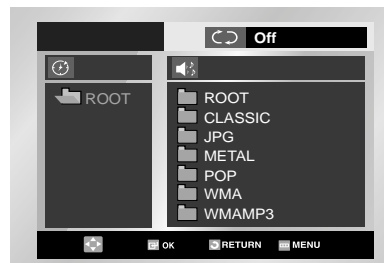

MP3-CD Playback

Data CDs (CD-Rs, CD-RWs) encoded in MP3 (MPEG1 Audio Layer 3) format can be played.

Before You Begin...

- Set the channel to "3" or use the TV/VIDEO button on the TV to select the input source.
- Press the DVD button on the remote control to switch to DVD mode.

- 1 Press the OPEN/CLOSE button to open the disc tray, and then load the MP3 disc.
 - ◆ The MP3 menu screen will appear. Depending on the MP3 disc, the appearance of the menu may be different.
- 2 Use ▲, ▼ buttons to select the folder, and then press the OK button.
 - ◆ A list of albums in the folder will appear.
 - To view the next album, press the RETURN button.
- 3 Use ▲, ▼ buttons to select ALBUM, and then press the OK button.
 - ◆ Select the track, and then press the OK button. Playback will start.
 - To select the previous track or next track, press ◀◀ or ▶▶.
- 4 To change the album, press the ■ button, and then press RETURN button.
 - ◆ A list of albums in the MP3-CD will appear.
 - To select another album and track, repeat Steps 2 and 3 above.
- 5 Press the ■ button to stop playback.
 - ◆ Playback of MP3-CD track will stop.
- 6 Press the RETURN button to return to the initial MP3 menu.

-
- Depending the MP3 disc, it may take longer to start playing.
 - The following types of data CDs can be played: ISO 9660 level 1, level 3, or Joliet format CD-ROMs, CD-Rs, and CD-RWs; discs recorded with a compression/decompression data rate greater than 128Kbps; and discs containing files with the "MP3" or "mp3" extension.
 - Multisession CDs with a blank segment and MP3 CD-Rs encoded in VBR (Variable Bit Rate) format cannot be played.
 - MP3 files names should be 8 characters or less in length. Korean characters or special characters cannot be displayed.
 - Each time you press the REPEAT button in PLAY mode, the selection will switch a follows: Off →Track →Folder →RANDOM

WMA Disc Playback

Before You Begin...

- Set the channel to "3" or use the TV/VIDEO button on the TV to select the input source.
- Press the DVD button on the remote control to switch to DVD mode.

- 1 Press the OPEN/CLOSE button to open the disc tray, and then load the disc.
 - ◆ Load the disc with the labeled side up.
- 2 Press the OPEN/CLOSE button to close the disc tray.
 - ◆ As the disc tray is closing, the screen will appear.
- 3 Use ▲, ▼ to select the song you want to play.
 - ◆ To play back Press OK button.
 - ◆ To change the directory Press ■ button, and then - Press RETURN button to move to the upper most directory and use ▲, ▼ to select the desired folder.
 - ◆ To stop playback Press ■ button.
 - ◆ To temporarily stop playback, Press ▶|| button.
 - ◆ To resume playback, Press ▶|| button.

- Depending on the recording mode, some WMA CDs cannot be played.

CD-R MP3/WMA discs

When you record MP3 files on the CD-R, please refer to the following.

- **Your MP3 or WMA files should be ISO 9660 or JOLIET format.**
ISO 9660 format and Joliet MP3 or WMA files are compatible with Microsoft's DOS and Windows, and with Apple's Mac. These two formats are the most widely used.
- **When naming your MP3 or WMA files do not exceed 8 characters, and place ".mp3, .wma" as the file extension.**
General name format of: Title.mp3. or Title.wma. When composing your title, make sure that you use 8 characters or less, have no spaces in the name, and avoid the use of special characters including: (.,/, \, =, +).
- **Use a decompression transfer rate of at least 128 Kbps when recording MP3 files.**
Sound quality with MP3 files basically depends on the rate of compression/decompression you choose. Getting audio CD sound quality requires an analog/digital sampling rate, that is conversion to MP3 format, of at least 128 Kbps and up to 160 Kbps. However, choosing higher rates, like 192 Kbps or more, only rarely give better sound quality.
Conversely, files with decompression rates below 128 Kbps will not be played properly.
- **Use a decompression transfer rate of at least 64Kbps when recording WMA files.**
Sound quality with WMA files basically depends on the rate of compression/decompression you choose. Getting audio CD sound quality requires an analog/digital sampling rate, that is conversion to WMA format, of at least 64Kbps and up to 192Kbps.
Conversely, files with decompression rates below 64Kbps or over 192Kbps will not be played properly.
- **Do not try recording copyright protected MP3 files.**
Certain "secured" files are encrypted and code protected to prevent illegal copying. These files are of the following types: Windows Media™ (registered trade mark of Microsoft Inc) and SDMI™ (registered trade mark of The SDMI Foundation). You cannot copy such files.
- **Important:** The above recommendations cannot be taken as a guarantee that the DVD player will play MP3 recordings, or as an assurance of sound quality.
You should note that certain technologies and methods for MP3 file recording on CD-Rs prevent optimal playback of these files on your DVD player (degraded sound quality and in some cases, inability of the player to read the files).
- This unit can play a maximum of 500 files and 300 folders per disc.

You can listen to songs randomly or in the desired sequence.

Up to 20 tracks can be programmed.

This function is available only with Audio CDs.

Before You Begin...

- **Set the channel to "3" or use the TV/VIDEO button on the TV to select the input source.**
- **Press the DVD button on the remote control to switch to DVD mode.**

- 1 In STOP mode, press the REPEAT button.
◆ The Playback Sequence menu will appear.
- 2 Use ◀, ▶ buttons to select PROGRAM, and then press the OK button.
◆ The Selective Play screen will appear.
- Select <RANDOM> and press the OK button to play tracks in random order.
- 3 Use ▲, ▼ or ◀, ▶ buttons to select the desired track (CD), and then press the OK button.
◆ The selected track will be added to the Program order.
- Press the CLEAR button. The track added last will be deleted from the Program order.
- 4 To finish programming and start playback, press the ▶|| button.
◆ Tracks will play in the order they are added.

-
- If the disc tray is opened during programming, Program Play will be canceled.
 - Program Play can be set only when the CD is not playing.

- **To Cancel Programming**
- **Press the REPEAT or RETURN button.**
The program will not be saved and the program screen will disappear.
- **To Cancel Program Play**
- **During playback or in Stop mode, press the CLEAR button.**

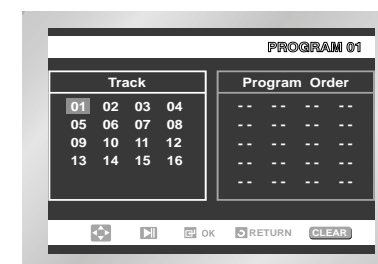
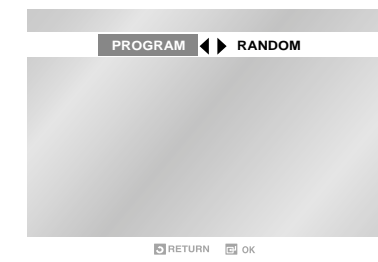

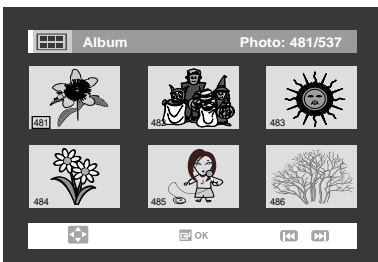
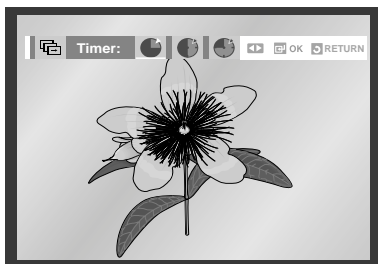
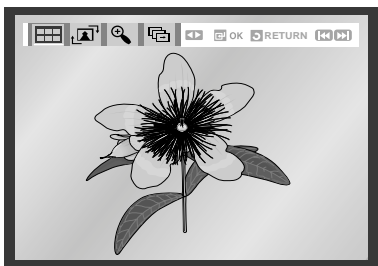
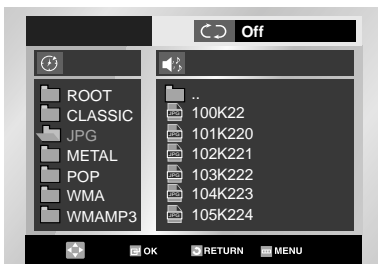
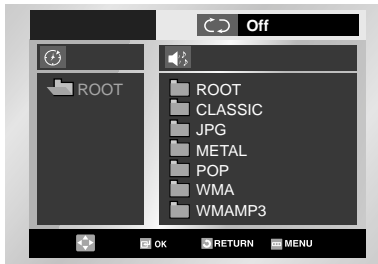

Before You Begin...

- Set the channel to "3" or use the TV/VIDEO button on the TV to select the input source.
- Press the DVD button on the remote control to switch to DVD mode.

- 1 Press the OPEN/CLOSE button to open the disc tray, and then load the disc.
 - ◆ Load the disc with the labeled side up.
- 2 Press the OPEN/CLOSE button to close the disc tray.
 - ◆ As the disc tray is closing, the screen shown on the left will appear.
- 3 Use ▲, ▼ buttons on the remote control to select the picture you want to view, and then press the OK button. The screen shown in the middle will appear. (Press ►|| to switch to Slide Show mode.)

- **Album:** Displays thumbnail images.
- **In the thumbnail screen**
 - To view the next 6 pictures, press (▶▶).
 - To view the previous 6 pictures, press (◀◀).
- **Rotate :** Each time the OK button is pressed, the image will rotate clockwise 90 degrees.
- **Zoom :** Each time the OK button is pressed, the image will enlarge up to 4X. (Normal → 2X → 4X → 2X → Normal)
- **Slide Show :** Starts the slide show.
 - **Fast :** The pictures change automatically at about a 6-second interval.
 - **Normal :** The pictures change automatically at about a 12-second interval.
 - **Slow :** The pictures change automatically at about a 18-second interval.

CD-R JPEG Discs

- Only files with the ".jpg" and ".JPG" extensions can be played.
- If the disc is not closed, it will take longer to start playing and not all of the recorded files may be played.
- Only CD-R discs with JPEG files in ISO 9660 or Joliet format can be played.
- The name of the JPEG file may not be longer than 8 characters and should contain no blank spaces or special characters (. / = +).
- Only a consecutively written multisession disc can be played. If there is a blank segment in the multisession disc, the disc can be played only up to the blank segment.
- A maximum of 500 images can be stored on a single CD.
- Only Kodak Picture CDs can be played.
- When playing a Kodak Picture CD, only the JPEG files in the pictures folder can be played.
- Picture discs other than Kodak Picture CD may take longer to start playing or may not play at all.
- If a number of files in 1 Disc is over 500, only 500 JPEG file can be played.
- If a number of folders in 1 Disc is over 300, only JPEG files in 300 folders can be played.

➤ If no buttons on the remote control are pressed for 10 seconds, the menu will disappear. Press ▲, ▼ or ◀, ▶ buttons on the remote to display the menu again.

Setting the Delay Time

A delay effect can be added to the sound from the Center and Surround speakers to adjust the sound according to the acoustic condition of the listening room. Initially, the delay time is set to '0 ms'.

- When 5.1CH Surround Sound is played, you can enjoy the best sound if the distance between you and each speaker is the same. You can set the Delay Time in the Center/Surround Speakers to customize the sound to the acoustic of your room.

1 Setting the Center Speaker

If the distance of D_c is equal to or longer than the distance of D_f in the figure, set the mode as 0ms. Otherwise, change the setting according to the table.

$$(A) = D_f - D_c$$

2 Setting the Surround Speakers

If the distance of D_f is equal to the distance of D_s in the figure, set the mode as 0ms. Otherwise, change the setting according to the table.

$$(B) = D_f - D_s$$

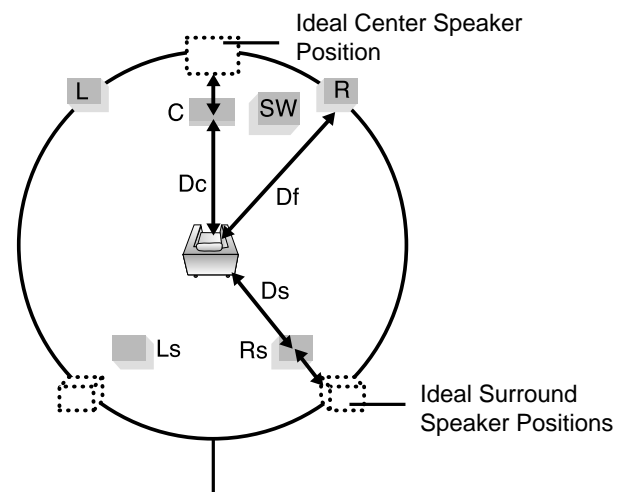

It is desirable to arrange all speakers within this circle.

Distance of (A) (m)	Setting (ms)
0.00	0
0.34	1
0.68	2
1.02	3
1.36	4
1.70	5

Distance of (B) (m)	Setting (ms)
0.00	0
1.02	3
2.04	6
3.06	9
4.08	12
5.10	15

About Speaker Setup

Ideal Speaker Arrangement

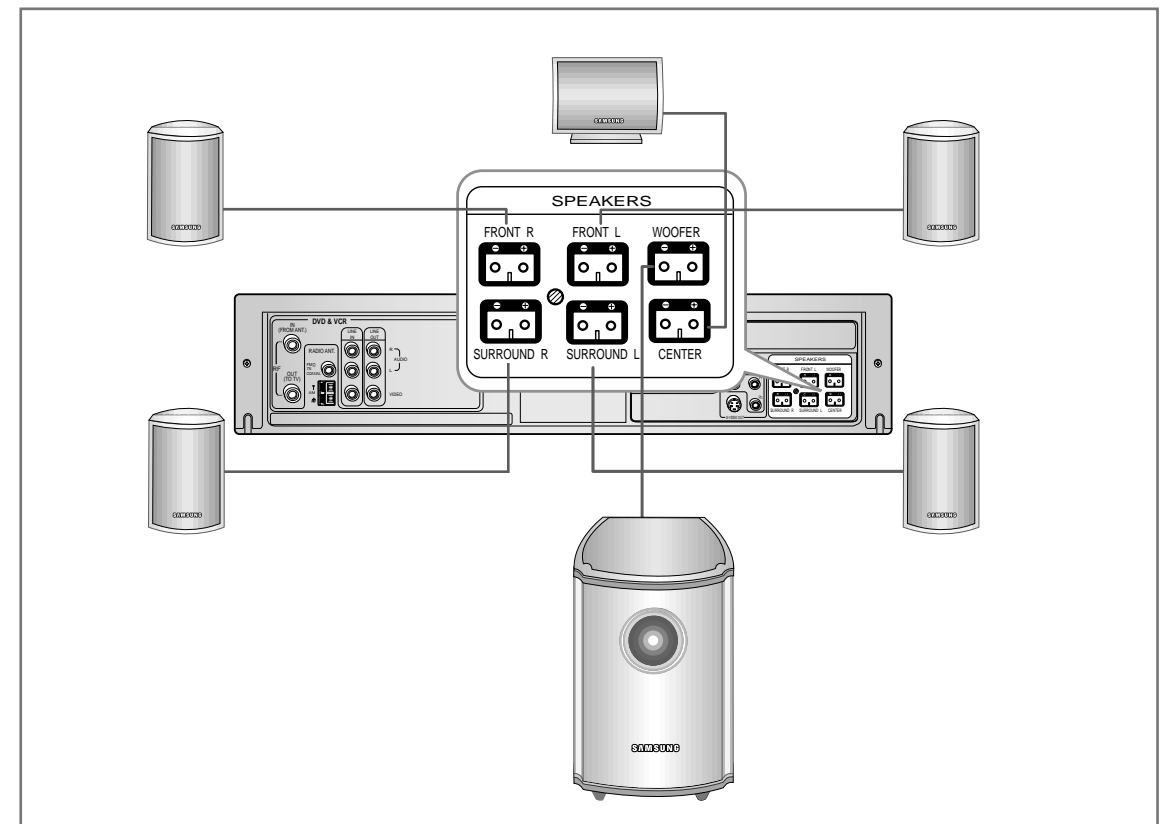

1 Center Speaker

Ideally, the center speaker should be positioned at the same height as the front speakers, but it may be placed above or below your TV set.

2 Surround Speakers

It is better to place these speakers behind your listening position, facing slightly downwards, about 24 to 35 inches (60-90 cm) above your ear. If your listening position is too close to the rear wall, place these speakers at the left and right of the listening position so that they face each other.

3 Front Speakers

It is better to place these speakers so that their tweeters are at your ear level, facing inwards (about 45°) toward you.

4 Subwoofer

The position of the subwoofer is not so critical. Place it anywhere you like.

- Please do not set up the Subwoofer near by TV or monitor because the Subwoofer is not fully magnetic shielded.

About Speaker Setup

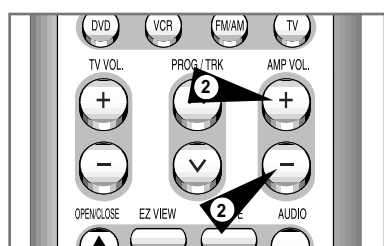
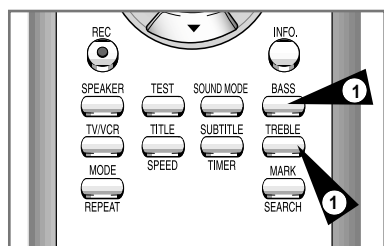
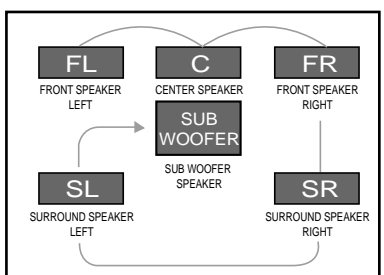
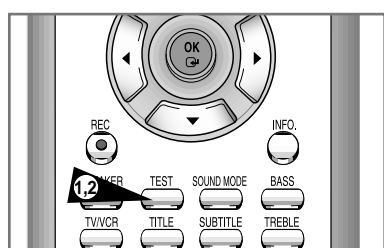
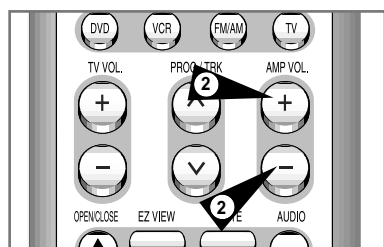
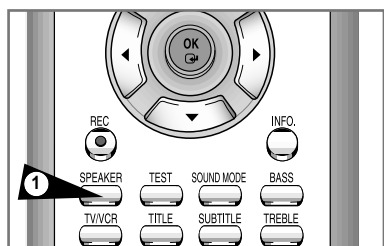

To Set the Speaker Balance

- 1 Press the SPEAKER button.
Each time you press the button, the selection will change as follows: FL → C → FR → SR → SL → SU → VOL.
- 2 Press AMP VOL + and AMP VOL - buttons to adjust the speaker volume.
The volume can be adjusted to a level between -10 and +10.

To Test the Speakers

- 1 In Stop mode, press the TEST button.
 - ◆ The test tone will be output to the speakers in the following order: FL (Front Speaker/L) → C (Center Speaker) → FR (Front Speaker/R) → SR (Surround Speaker/R) → SL (Surround Speaker/L) → SU (Subwoofer).
 - ◆ A hissing sound from a speaker indicates that the speaker is installed correctly.

- 2 To end the speaker test, press the TEST button again.

- While the test tone is being produced, you can use the VOL buttons to set the speaker balance for the selected channel.
- While the subwoofer is being tested, a low bass sound of 100Hz or 125Hz will be heard.

To Set the Bass/Treble

- 1 Press the BASS or TREBLE button.
Each time you press the BASS or TREBLE button, the corresponding setting will turn on or off.
- 2 Use AMP VOL + and AMP VOL - buttons to adjust the bass or treble of the speakers.
The bass or treble can be adjusted to a level between -10 and +10.

Sound Mode Function

Sound Mode

Press the SOUND MODE button.
Each time you press the button, the mode will change as shown at right.

- ◆ 4 STEREO/NATURAL/JAZZ/CONCERT/STADIUM – These effects are available in DSP mode.
 - NATURAL : When listening to regular audio (TV/Radio)
 - JAZZ : When listening to jazz or pop songs
 - CONCERT : When listening to classical music
 - STADIUM : When listening to live music or sports broadcast
 - 4 STEREO : When listening to the sound field effect close to the original sound
 - STEREO : When listening to the original sound using the front speakers and subwoofer
- ◆ MATRIX./MOVIE/MUSIC (Dolby Pro Logic II) – These effects are available in Dolby Pro Logic II mode.
 - MOVIE : Select this when watching a movie.
(You can experience the feeling of actually being at the movies.)
 - MUSIC : Select this when there are many musical elements.
(You can experience the feeling of actually being at a live concert.)
 - MATRIX : Select this if the source is regular audio.
(You can listen to mono tunes in 5.1-Ch Surround mode.)

Dolby Pro Logic II

Dolby Pro Logic II is new form of multi-channel audio signal decoding technique that is improved from the existing Dolby Pro Logic.

Dolby Pro Logic II separates Dolby Sound recordings as well as regular stereo audio (video audio, TV broadcast, external input) into 5.1 channels (front left and right, center, and surround left and right) so you can enjoy regular audio signals with 6 speakers. In addition, you can set different modes depending on the content and format of audio and more accurately adjust the sound field.

- Depending the type of disc being played, the effect of each surround mode may vary.
- During playback of a DVD encoded in 2 or more channels, a surround mode cannot be selected.
- When you select a surround mode during playback of a MP3, WMA or Audio CD, the 5.1-CH Surround Sound will be selected.

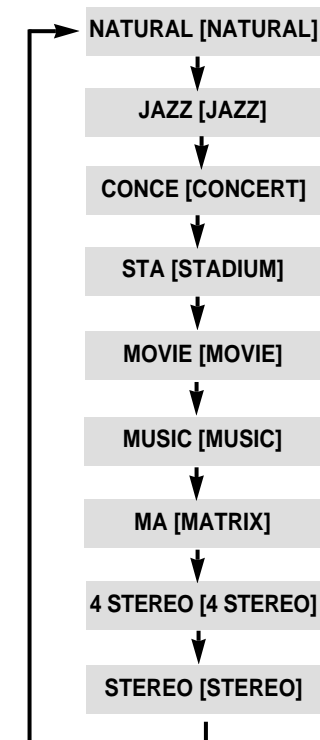
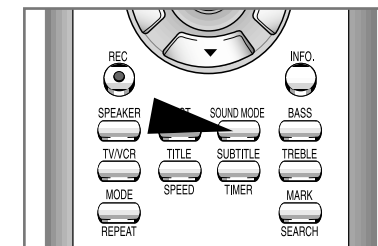

Listening to the Radio

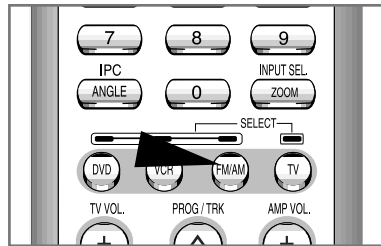

You can either automatically or manually tune in to an FM or AM station.

Press the FM/AM button.
Each time you press the button, the selection will toggle between FM and AM.

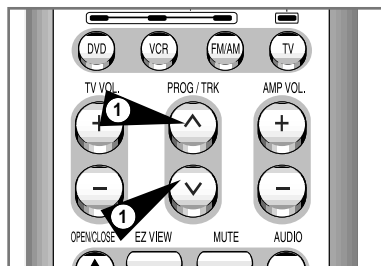

Tune in to the desired station.

- 1 **Automatic Tuning 1**
Press PROG \wedge / \vee button. A preset station will be selected on the front panel display panel of the DVD-VCR.
- 2 **Automatic Tuning 2**
Press and hold \lll or \ggg to begin automatic tuning.
- 3 **Automatic Tuning 3**
Press \lll or \ggg to tune in to a lower or higher frequency.

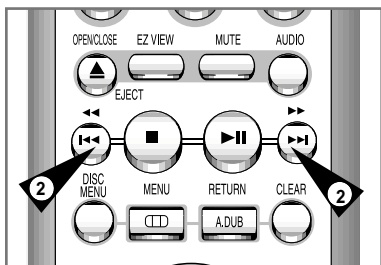

Presetting Stations

You can store up to 30 stations (20 FM stations and 10 AM stations).

Example: Storing an FM station of 87.50 MHz into the preset station number 01

- 1 Press the FM/AM button to select "FM".
Each time you press the button, the selection will toggle between FM and AM.
- 2 Use \lll and \ggg to tune in to FM 87.50.
- 3 Press the \blacksquare button or the OK button on the remote control. FM1 will blink on the display.
- 4 Select the reception mode and then select the preset station number.
- 5 Press the \blacksquare or OK button again to store 87.50 to FM 1.
- 6 Repeat steps 1 to 5 to store other stations. You can store up to 20 FM and 10 AM stations by using the PROG \wedge / \vee button.

➤ If the station you tuned in to is broadcasting in stereo, "STEREO" will be displayed.

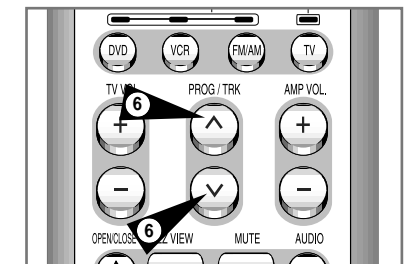
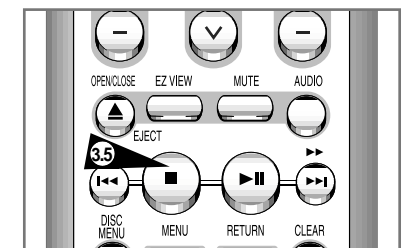
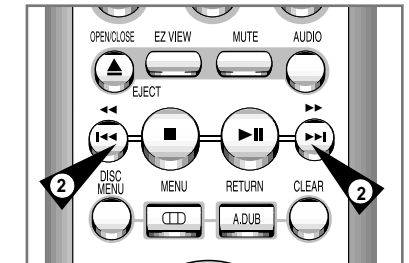
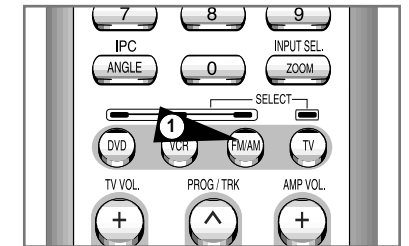

Technical Specifications

Input	Video input (Rear)	RCA jack : 1.0Vp-p (unbalanced) 75Ω		
	Audio input (Rear)	RCA jack : -8dBm, 47Kohm unbalanced		
Output	RF out	UHF 21-69 (Initial CH36)		
	Audio (DVD, VCR)	RCA jack		
	Video (DVD, VCR)	RCA jack		
	Video (DVD only)	S-Video out , Component out : RCA jack		
VCR	Tape format	VHS type video tape, S-VHS type video tape (Playback only)		
	Color system	PAL, MESECAM, NTSC4.43, NTSC playback on PAL TV		
	Tuning system	B/G, D/K		
	Video S/N	Above 43dB (standard recording)		
	Resolution	Above 240 lines (standard recording)		
	Audio S/N	Above 68dB (Hi-Fi), 39dB (Mono)		
	Audio frequency characteristics	20Hz - 20KHz (Hi-Fi)		
DVD	DISC COMPATIBILITY	CD, CD-R, CD-R/W, DVD-Video, CD-Digital Audio (5" and 3.5"), MP3 files on CD-ROM, WMA, Video-CD		
	S/N RATIO	110 dB		
	DYNAMIC RANGE	100 dB		
SYSTEM	POWER REQUIREMENT	AC220~240V, 50/60 Hz, 75W		
	ENVIRONMENT	41-104°F (5-40°C); 10%-75% humidity		
	WEIGHT	13.0 lbs (Combo) + 22.5 lbs (SPEAKER) = 35.5 lbs		
RECEIVER	SENSITIVITY	FM	AM	
		15 dB	64 dB	
	S/N RATIO	60 dB	35 dB	
	THD	0.5 %	2%	
AMP	FREQ. RESPONSE	20 Hz ~ 20 kHz		
	S/N RATIO	65 dB		
	CHANNEL SEPERATION	60 dB		
SPEAKER	SPEAKER SYSTEM	5.1 CHANNEL SPEAKER SYSTEM		
		FRONT/CENTER/SURROUND	SUBWOOFER SPEAKER	
	IMPEDANCE	6Ω X 5	3Ω	
	FREQ. RESPONSE	140Hz ~ 20000Hz	50Hz ~ 900Hz	
	SPL	77dB	83dB	
	SIZE	FRONT SURROUND	91(W)x135(D)x98.5(H)	130(W) x 320(D) x 335(H)
		CENTER	200(W)x107(D)x100(H)	
WEIGHT	FRONT SURROUND	0.75Kg, 0.74Kg	4.3Kg	
	CENTER	0.92Kg		

Problems and Solutions (VCR)

Before contacting the Samsung after-sales service, perform the following simple checks.

Problem	Explanation/Solution
No power	<ul style="list-style-type: none"> ◆ Check that the power plug is connected to a wall outlet. ◆ Have you pressed the STANDBY/ON button?
You cannot insert a video cassette	<ul style="list-style-type: none"> ◆ A video cassette can only be inserted with the window side up and the safety tab facing you.
The television programme was not recorded	<ul style="list-style-type: none"> ◆ Check the DVD-VCR aerial connections. ◆ Is the DVD-VCR tuner properly set? ◆ Check if the safety tab is intact on the cassette.
Timer recording was unsuccessful	<ul style="list-style-type: none"> ◆ Was the STANDBY/ON button pressed to activate the timer? ◆ Re-check the recording start/stop time settings. ◆ If there was a power failure or interruption during timer recording, the recording will have been cancelled.
No playback picture or the picture is distorted	<ul style="list-style-type: none"> ◆ Check to see if you are using a prerecorded tape.
You cannot see normal broadcasts	<ul style="list-style-type: none"> ◆ Check the TUNER/EXTERNAL setting. It should be on TUNER. ◆ Check the TV/VCR aerial connections.
Noise bars or streaks on playback	<ul style="list-style-type: none"> ◆ Press the TRK (^ or v) buttons to minimize this effect.
When the ► button is pressed during playback, the still picture has severe "noise bars" streaks	<ul style="list-style-type: none"> ◆ A still picture may have "noise bars", depending on the condition of the tape. Press the TRK (^ or v) buttons during SLOW motion to minimize this effect.
Video Head Cleaning	<ul style="list-style-type: none"> ◆ If poor pictures appear on a variety of cassettes, the video heads may need cleaning. This is not a common problem and unless it appears, the heads should not be cleaned. When cleaning the video heads, read all instructions provided with the head cleaning cassette. Incorrect head cleaning can permanently damage the video heads.
If when tuning in your TV to the DVD-VCR TV does not find the Screen or the pattern when found suffers from interference, it may be due to the DVD-VCR output channel clashing with the normal TV transmissions in your area. To prevent this you will need to change the DVD-VCR output channel in the following way	<ol style="list-style-type: none"> 1. Remove the aerial input plug from the socket marked (aerial symbol) on the rear of the DVD-VCR. 2. Carry out the instructions "Tuning Your Television for the DVD-VCR" (see page 14). 3. Carry out the instructions "Setting the DVD-VCR output Channel" (see page 23), move the channel number several channels down from the original setting. (example: from 36 to 39). 4. Replace the aerial plug into the socket marked (aerial symbol) on the rear of the DVD-VCR. 5. Re-tune your TV to the DVD-VCR again by following instructions "Tuning Your Television for the DVD-VCR" (page 14). 6. If the problem still exists repeat steps 1 to 5 moving several more channels away from the original setting.

If you are unable to solve the problem after reading the above instructions, note:

- ◆ The model and serial number on the rear of your DVD-VCR
- ◆ The warranty information
- ◆ A clear description of the problem

Then contact your nearest SAMSUNG after-sales service.

Before requesting service (troubleshooting)

GB

Problem	Action	Page
Disc does not play.	<ul style="list-style-type: none"> ◆ Ensure that the disc is installed with the label side facing up. ◆ Check the region number of the DVD. ◆ This player cannot play CD-ROMs, DVD-ROMs, etc. Insert a DVD, a VIDEO-CD or a CD. 	P6
5.1 channel sound is not being reproduced.	<ul style="list-style-type: none"> ◆ 5.1 channel sound is reproduced only when the following conditions are met. : <ol style="list-style-type: none"> 1) The DVD-VCR player is connected with the proper amplifier 2) The disc is recorded with 5.1 channel sound. ◆ Check whether the disc being played has the "Dolby 5.1 ch" mark on the outside. ◆ Check if your audio system is connected and working properly. 	P45 P48
The  icon appears on screen.	<ul style="list-style-type: none"> ◆ The features or action cannot be completed at this time because: <ol style="list-style-type: none"> 1. The DVD's software restricts it. 2. The DVD's software doesn't support the feature (e.g., angles). 3. The feature is not available at the moment. 4. You've requested a title or chapter number or search time that is out of range. 	P45-62
Playback mode differs from the Setup Menu selection.	<ul style="list-style-type: none"> ◆ Some of the functions selected in the Setup Menu may not work properly if the disc is not encoded with the corresponding function. 	P46-50
The screen ratio cannot be changed.	<ul style="list-style-type: none"> ◆ The Screen Ratio is fixed on your DVDs. 	P50
No audio.	<ul style="list-style-type: none"> ◆ Make sure you have selected the correct Digital Output in the Audio Options Menu. 	P48
Forgot password	<ul style="list-style-type: none"> ◆ Press STANDBY/ON from a cold start with no disc in the unit. Press the ◀ and ▶ buttons simultaneously on the front panel for five seconds. Switch off and on the DVD-VCR by pressing STANDBY/ON button. The Parental Mode is now unlocked as indicated on the display. You can now set your rating level and change your password to a new number. 	P49
If you experience other problems.	<ul style="list-style-type: none"> ◆ Go to the contents and find the section of the instruction book that contains the explanations regarding the current problem, and follow the procedure once again. ◆ If the problem still cannot be solved, please contact your nearest authorized service center. 	

THIS APPLIANCE IS DISTRIBUTED BY

