

- ◆ FOREWORD
 - Safety Instructions..... 5
 - Disc Type and Characteristics 6
- ◆ DVD-VCR OVERVIEWS
 - Front View of the DVD-VCR..... 7
 - Rear View of the DVD-VCR 7
 - Infrared Remote Control..... 8
 - Display Indicators..... 9
 - Accessories..... 9
- ◆ CONNECTING YOUR DVD-VCR
 - Deciding How to Connect DVD-VCR 10
 - Connecting DVD-VCR to the TV using the RCA Cable 11
 - Connecting DVD-VCR to a Satellite Receiver or Other Equipment 12
 - Deck Control Keys 13
 - Copying from DVD or VCR 14
 - Inserting Batteries in the Remote Control 15
 - Setting the Date and Time 15
 - Setting the Menu Language..... 16
- ◆ SETTING UP YOUR DVD-VCR
 - Selecting the Colour Mode..... 17
 - Intelligent Picture Control 18
 - Intelligent Picture Control (Remote Control) 18
 - Auto Power off..... 19
 - Screen Message 20
 - Selecting the Cassette Type 20
 - Repeat Play..... 21
 - S-VHS Play 21
- ◆ RECORDING TELEVISION BROADCASTS
 - Selecting the Recording Speed 22
 - Protecting a Recorded Cassette..... 23
 - Recording a Programme Immediately 23
 - Recording a Programme with Automatic Stop..... 24

- ◆ PLAYING BACK
 - Playing a Cassette 25
 - Adjusting Picture Alignment Manually 25
 - Selecting the Audio Output Mode 26
 - Playing a Cassette in Slow Motion..... 26
 - Playing a Sequence Frame by Frame..... 27
 - Playing a Sequence at Variable Speeds 27
 - Searching for a Specific Sequence 28
 - Using the Tape Counter..... 30
 - Connecting an RCA Audio/Video Input Cable..... 31
 - Using the Assemble Edit Function 32
 - Recording from Another VCR or Camcorder 32
- ◆ KARAOKE FUNCTIONS (VCR)
 - Using the KARAOKE Function..... 33
 - SCORE Function..... 33
 - KARAOKE SEARCH Function 33
- ◆ DVD FUNCTIONS
 - Choosing a Connection 34
 - Setting Up the Language Features..... 35
 - Setting Up the Audio Options 37
 - Setting Up the Display Options 38
 - Setting Up the Parental Control 39
 - A/V Receiver Connections 40
 - Special Playback Features..... 41
 - Adjusting the Aspect Ratio (EZ View) 42
 - Using the Display Function..... 44
 - Changing the Camera Angle 45
 - Selecting the Subtitle Language 45
 - Repeat Play..... 46
 - Selecting the Audio Language 47
 - Using the Mark Function 48
 - MP3/WMA Play..... 49
 - Program Play & Random Play 51
 - Picture CD Playback..... 52

- ◆ KARAOKE FUNCTIONS (DVD)
 - Beginning Karaoke Functions 54
 - Key Control 54
 - Reserving a Song..... 55
 - Cancellation of reservation..... 55
 - Vocal Fader..... 56
 - Guide Melody 56
 - Score Function 56
 - Types of Karaoke disc 56
- ◆ SOLVING PROBLEMS
 - Technical Specifications..... 57
 - Problems and Solutions (VCR) 58
 - Troubleshooting Guide (DVD) 59

This product incorporates copyright protection technology that is protected by method claims of certain U.S. patents and other intellectual property rights owned by Macrovision Corporation and other rights owners. Use of this copyright protection technology must be authorized by Macrovision Corporation, and is intended for home and other limited viewing uses only unless otherwise authorized by Macrovision Corporation. Reverse engineering or disassembly is prohibited.

Symbols

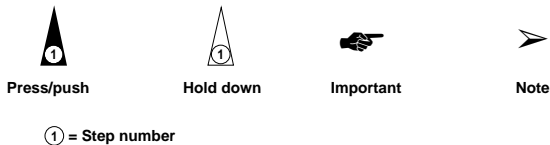

The following illustrations represent precautions.



The lightning bolt is a warning sign alerting you to dangerous voltage inside the product. DO NOT OPEN THE DVD-VCR. Refer to service personnel.

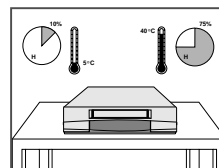

Do NOT expose the DVD-VCR to extreme temperature conditions (below 5°C and above 40°C) or to extreme humidity conditions (less than 10% and more than 75%).

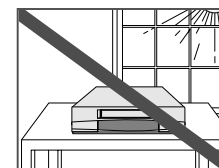

Do NOT expose the DVD-VCR to direct sunlight.

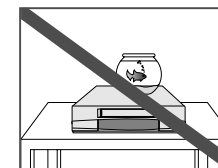

Do NOT expose the DVD-VCR to any liquids.

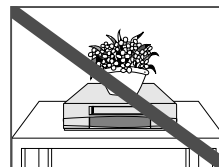

Do NOT place any objects on the DVD-VCR or remote control.

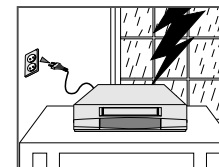

During a storm and/or lightning, unplug the DVD-VCR from the mains socket and aerial.

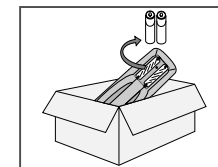



If the remote control is not used for a long period of time, remove the batteries and store it in a cool, dry place.

THIS DEVICE IS NOT FOR USE IN INDUSTRIAL ENVIRONMENTS

Disc Type and Characteristics

This DVD player is capable of playing the following types of discs with the corresponding logos :

Disc Types (Logos)	Recording Types	Disc Size	Max. Playing Time	Characteristics
	Audio + Video	12 Cm	Single-sided 240 min. Double-sided 480 min.	<ul style="list-style-type: none"> DVD contains excellent sound and video due to Dolby Digital and MPEG-2 system. Various screen and audio functions can be easily selected through the on-screen menu.
		8 Cm	Single-sided 80 min. Double-sided 160 min.	
	Audio + Video	12 Cm	74 min.	<ul style="list-style-type: none"> Video with CD sound, VHS quality & MPEG-1 compression technology.
		8 Cm	20 min.	
	Audio	12 Cm	74 min.	<ul style="list-style-type: none"> An LP is recorded as an analog signal with more distortion. CD is recorded as a Digital Signal with better audio quality, less distortion and less deterioration of audio quality over time.
		8 Cm	20 min.	

* DO NOT play CD-ROM, CD-I and DVD-ROM in this player!
(CDGs play audio only, not graphics.)

Disc Markings



PAL

NTSC



STEREO

DIGITAL SOUND



• Playback Region Number

• PAL colour system in U.K, France, Germany, etc.

• NTSC broadcast system in USA, Canada, Japan, South Korea, etc.

• Dolby Digital disc

• Stereo disc

• Digital Audio disc

• DTS disc

Playback Region Number

Both the DVD player and the discs are coded by region. These regional codes must match in order for the disc to play. If the codes do not match, the disc will not play.

The Region Number for this player is described on the rear panel of the player.

Front View of the DVD-VCR

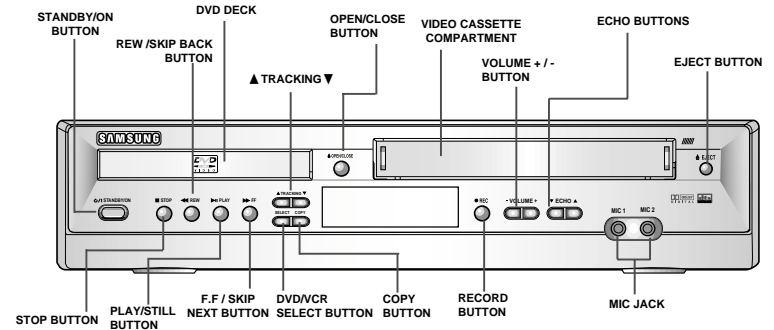

Rear View of the DVD-VCR

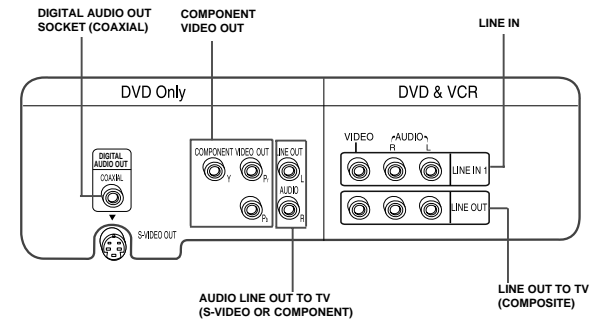







Deciding How to Connect DVD-VCR

You must take into account various factors when connecting audio or video systems:

- ◆ Types of connectors available on your systems
- ◆ Systems connected permanently to the DVD-VCR (satellite receiver for example) or temporarily (camcorder for example)

Your DVD-VCR is equipped with the following connectors.

Connector	Location	Type	Direction	Recommended Use
MIC JACK	Front 	MIC JACK	In ↳	◆ MIC
LINE	Rear 	Audio/Video RCA	In/Out ↳	◆ Television ◆ Other VCR
Audio output	Rear 	Audio RCA	Out ↳	◆ Audio out (DVD only)
COMPONENT output	Rear 	RCA	Out ↳	◆ COMPONENT out (DVD only)
Digital AUDIO output	Rear 	Coaxial	Out ↳	◆ Digital Audio out (DVD only)
S-VIDEO output	Rear 	S-JACK	Out ↳	◆ S-Video out (DVD only)

 Whenever you connect an audio or video system to your DVD-VCR, ensure that all elements are switched off.

Refer to the documentation supplied with your equipment for detailed connection instructions and associated safety precautions.

Connecting DVD-VCR to the TV using the RCA Cable

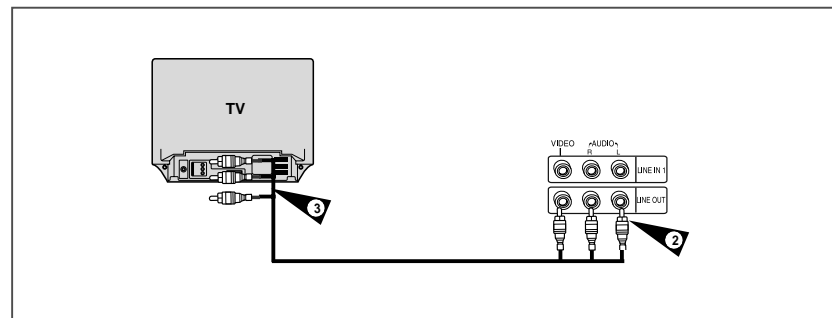

You can connect your DVD-VCR to the television using the RCA cable if the appropriate input is available on the television. You thus:

- ◆ Obtain better quality sound and pictures
 - ◆ Simplify the setting up procedure of your DVD-VCR
-  ◆ Make sure that both the television and the DVD-VCR are switched off before connecting the cables.

- 1 Connect one end of the RCA Audio/Video cable to the Video output and Audio L, R output socket on the rear of the DVD-VCR.
- 2 Plug the other end into the appropriate connector on the television.

Connecting DVD-VCR to a Satellite Receiver or Other Equipment

You can connect other audio and/or video equipment to your DVD-VCR in different ways. The following illustrations give a few examples of the connection possibilities.

➤ The RCA input/output connectors on the rear of the DVD-VCR are used for equipment, such as camcorders, VCRs or sound systems.

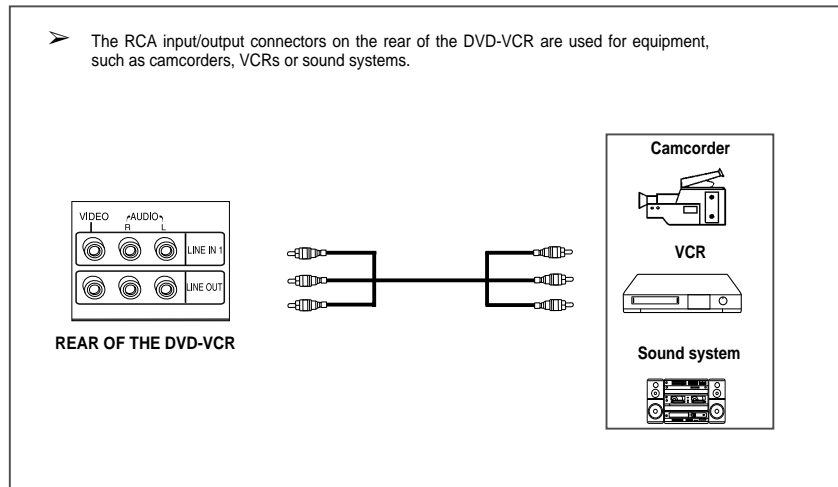

Deck Control Keys

The DVD-VCR uses one set of controls to operate both decks. The following keys are helpful in successfully controlling each deck.

- 1 **STANDBY/ON Button**
Press the STANDBY/ON button on the remote control or front panel to turn on the DVD-VCR.
- 2 **DVD Button**
Press the DVD button on the remote control when you want to control the DVD deck.
◆ The DVD indicator will light on the Front Panel Display to show that the DVD deck is selected.
- 3 **VCR Button**
Press the VCR button on remote control when you want to control the VCR deck.
◆ The VCR indicator will light on the Front Panel Display to show that VHS deck is selected.
- 4 **DVD-VCR Toggle**
Press the SELECT button on the front panel to toggle control between the DVD deck and the VCR deck.

➤ Before using the VCR operation of 17~33 pages, press the VCR button on the remote control to select VCR mode.

Before using the DVD operation of 34~56 pages, press the DVD button on the remote control to select and watch DVD.

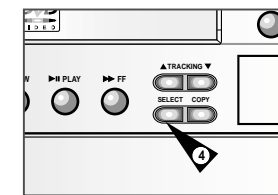
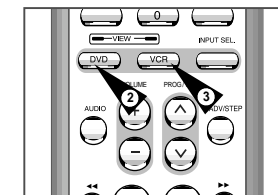
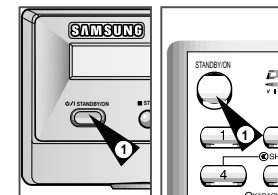

Copying from DVD to VCR

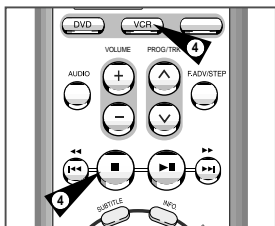
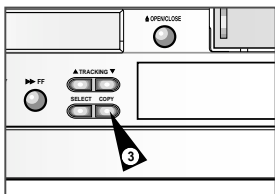
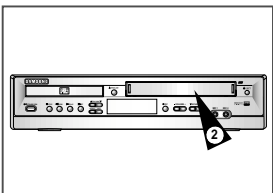
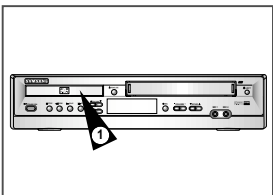

The DVD-VCR allows you to copy the contents of a DVD to a VHS tape with a press of the COPY button.

If the DVD you are attempting to copy is copy protected, you will not be able to copy the disc. It is not permitted to copy Macrovision® encoded DVDs.

- 1 **Insert Disc**
Insert the DVD you wish to copy in the DVD deck and close the drawer.
- 2 **Insert VHS Tape**
Insert a blank VHS videotape into the VCR deck.
- 3 **Copy the DVD to VHS Tape**
Press the COPY button on the DVD-VCR front panel.
◆ The DVD will go into Play mode and the VCR will go into Record mode.
- 4 **Stop the Copy Process**
When the DVD is finished playing, press the VCR button on the remote control and then press the STOP button to end the copy.
◆ You must stop the Copy process manually when the DVD movie ends or the DVD may replay and record over and over again.

☞ For NTSC DVD or VCD copy

- ◆ Before starting the copy process, set the Quasi PAL to Off in Display options of SETUP MENU (see page 38).
- ◆ If Quasi PAL is On, the copy process can not active.
- ◆ The copy is only active PAL tape system.

Inserting Batteries in the Remote Control

You must insert or replace the batteries in the remote control when you:

- ◆ Purchase the DVD-VCR
- ◆ Find that the remote control is no longer working correctly

- 1 Push the tab in the direction of the arrow to release the battery compartment cover on the rear of the remote control.
- 2 Insert two AAA, RO3 or equivalent batteries, taking care to respect the polarities:
◆ + on the battery with + on the remote control
◆ - on the battery with - on the remote control
- 3 Replace the cover by aligning it with the base of the remote control and pushing it back into place.

➤ Do not mix different battery types (manganese and alkaline for example).

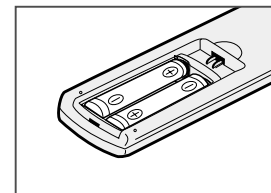
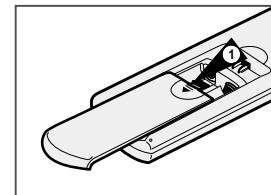

Setting the Date and Time

Your DVD-VCR contains a 24-hour clock and calendar used to:

- ◆ Automatically stop programme recording
- ◆ Preset your DVD-VCR to record a programme automatically

You must set the date and time when:

- ◆ You purchase the DVD-VCR
- ☞ Do not forget to reset the time when you change clocks from winter to summer time and vice versa.

- 1 After pressing the MENU, press the OK or ►.
Result: The Setup menu is displayed.
- 2 Press the corresponding ▲, ▼ buttons to select the Clock option.
- 3 Press the OK or ► to select this option.
Result: The Clock Set menu is displayed.
- 4 Press ◀ or ► to select the hour, minutes, day, month and year.
Result: The option selected highlight.
- 5 Press the ▲ or ▼ buttons to increase or decrease the value.
Result: The day of the week is displayed automatically.
➤ You can hold the ▲ or ▼ buttons down to scroll more quickly through the values.
- 6 On completion, press RETURN to exit the menu.

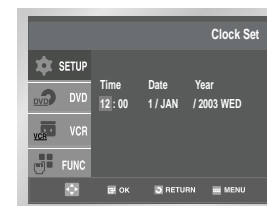

Setting the Menu Language

GB

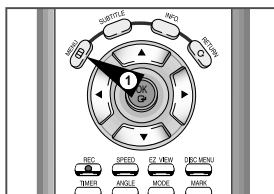

1 Open "MENU"

After pressing the MENU, press the OK or ►.

2 Select "Language"

Use the ▲ or ▼ buttons to highlight "Language," then press the OK or ►.

3 Set menu Language

Place the selection arrow next to your desired Language, then press the OK button.

4 Press the ▲ or ▼ buttons to select language you want.

Place the selection arrow next to your desired Language, then press the OK button.

5 On completion, press RETURN to exit the menu.



Before recording or playing back a cassette, you can select the required system standard.

- ◆ When you playback an NTSC-recorded tape on this DVD-VCR make a setting on the colour system according to your TV. If your TV is a PAL system only TV, set NTPB. If your TV is Multi System TV (NTSC 4.43 compatible), set NT4.43 and you can record NT4.43.

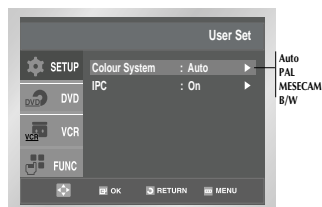

- 1 After pressing the MENU, press the OK or ►.
Result: The Setup menu is displayed.
- 2 Press the corresponding ▲, ▼ buttons to select the **User Set** option.
- 3 Press the OK or ► to select this option.
Result: The **User Set** menu is displayed.
- 4 Press the corresponding ▲ or ▼ buttons, until the **Colour System** option is selected.
- 5 Press the OK or ► button to select **Auto** → **PAL** → **MESECAM** → **B/W**.

B/W	Black and White
------------	-----------------
- 6 On completion, press RETURN three time to exit the menu.

VCR Intelligent Picture Control

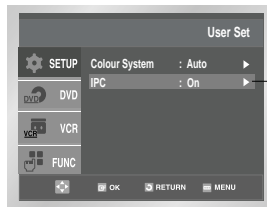
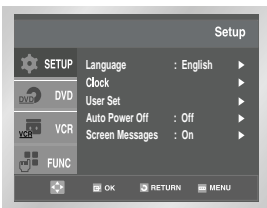

On
Off

The Intelligent Picture Control Feature allows you to adjust the sharpness of the image automatically, according to your own preferences.

- 1 During playback, press the MENU button on the remote control.
Result: The Setup menu is displayed.
- 2 Press the OK or ► button.
Result: The Setup menu is displayed.
- 3 Press the corresponding ▲, ▼ buttons to select the **User Set** option.
- 4 Press the OK or ► buttons to select this option.
Result: The **User Set** menu is displayed.
- 5 Press the corresponding ▲ or ▼ buttons, until the **IPC** option is selected.
- 6 Press the Ok or ► buttons to select the IPC (intelligent picture control) option.
➤ When intelligent picture control mode is **ON**, the sharpness of the image is adjusted automatically.
- 7 To adjust the sharpness manually, press the ▼ button to turn the IPC mode **OFF**.
- 8 Press the ◀ or ► buttons until the picture is displayed according to your preferences.
➤ If you do not press a button within ten seconds, the **PICTURE** menu disappears automatically.
- 9 On completion, press the RETURN button again.

Auto Power Off

VCR

The Auto Power Off feature automatically turns off your DVD-VCR if no signal is received and you do not press any button for the selected time.

- 1 After pressing the MENU, press the OK or ► button.
Result: The Setup menu is displayed.
- 2 Press the corresponding ▲ or ▼ buttons, until the **Auto Power Off** option is selected.
- 3 Press the OK or ► buttons, until you select the time of Auto Power Off interval.

► Off → 1Hour → 2Hour → 3Hour
- 4 On completion, press RETURN twice to exit the menu.



Off
1Hour
2Hour
3Hour

VCR Intelligent Picture Control (Remote Control)

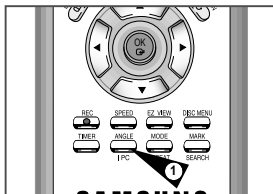

- 1 During playback, press the IPC button.
Result: The **PICTURE** menu is displayed.
- 2 Press the ▼ button to turn the IPC (Intelligent Picture Control) option **ON** and **OFF**.
➤ When Intelligent Picture Control mode is **ON**, the sharpness of the image is adjusted automatically.
- 3 To adjust the sharpness manually, select Intelligent Picture Control mode **OFF**.
◆ The horizontal picture adjusting appears.
- 4 Press the ◀ or ► buttons until the picture is displayed according to your preferences.
➤ If you do not press a button within ten seconds, the **PICTURE** menu disappears automatically.
- 5 On completion, press the IPC button again.

VCR Screen Messages

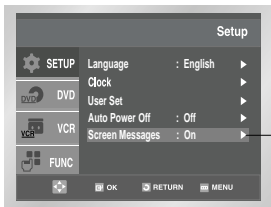

On
Off

Your DVD-VCR displays most information both on the DVD-VCR and the television.

You can choose to display or hide this information on the television screen (except for the **SEARCH**, **Programming MENU** and **Timer functions**, which cannot be hidden).

- 1 After pressing the MENU, press the OK or ►. **Result:** The Setup menu is displayed.
- 2 Press the corresponding ▲ or ▼ buttons, until the **Screen Messages** option is selected.
- 3 **To...** **Press OK or ►, until...**

Display on-screen information	On is displayed.
Hide on-screen information	Off is displayed.
- 4 On completion, press RETURN twice to exit the menu.

Repeat Play

You can set repeat play to repeat the tape continuously from beginning to end.

- 1 After pressing the MENU, press the corresponding ▲, ▼ buttons to select the **VCR** option.
- 2 Press the OK or ► buttons to select this option. **Result:** The **VCR Setup** menu is displayed.
- 3 Press the corresponding ▲ or ▼ buttons, until the **Repeat Play** option is selected.
- 4 **To...** **Press OK or ►, until...**

Repeat play	On is displayed.
Do not wish to repeat play	Off is displayed.
- 5 On completion, press RETURN twice to exit the menu.

VCR

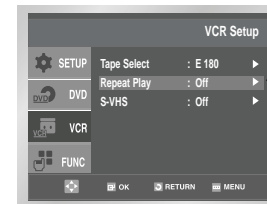
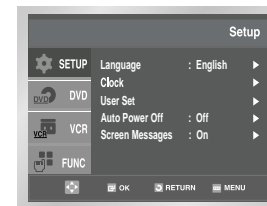

Off
On

VCR Selecting the Cassette Type

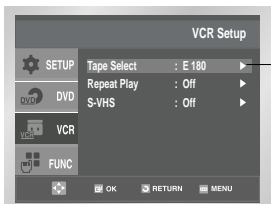
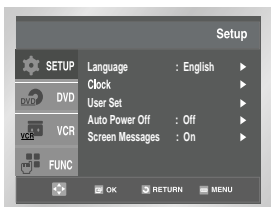

E180
E240
E260
E300

If you wish to use the tape counter to display the time remaining on a cassette, you must indicate the type of cassette inserted.

- 1 After pressing the MENU press the corresponding ▲, ▼ buttons to select the **VCR** option.
- 2 Press the OK or ► buttons to select this option. **Result:** The **VCR Setup** menu is displayed.
- 3 Press the corresponding ▲ or ▼ buttons, until the **Tape Select** option is selected.
- 4 Press the OK or ► buttons as many times as required, until the correct cassette length is displayed.

→	E180	→	E240	←	E260	←	E300
---	------	---	------	---	------	---	------
- 5 Press RETURN twice to exit the menu.

S-VHS Play

The DVD-VCR allows you to playback high quality S-VHS tapes.

- 1 During S-VHS play mode after pressing the MENU press the corresponding ▲, ▼ buttons to select the **VCR** option.
- 2 Press the OK or ► button to select this option. **Result:** The **VCR Setup** menu is displayed.
- 3 Press the corresponding ▲ or ▼ buttons, until the **S-VHS** option is selected.
- 4 **To...** **Press OK or ►, until...**

S-VHS play	On is displayed.
Do not wish to S-VHS play	Off is displayed.
- 5 On completion, press RETURN twice to exit the menu. To watch S-VHS tapes, set the S-VHS mode to **On** in the VCR Setup.

VCR

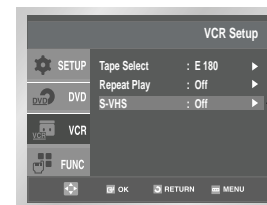
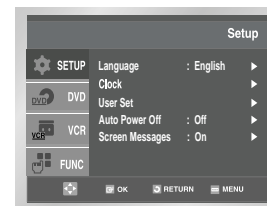

Off
On

VCR Selecting the Recording Speed

GB

Type	Recording Time (in SP)
E-180	180 mins. or 3 hours
E-240	240 mins. or 4 hours
E-260	260 mins. or 4 hours and 20 mins.
E-300	300 mins. or 5 hours

You can record a cassette at two different speeds:

- ◆ SP (Standard Play)
- ◆ LP (Long Play)

In Long Play modes:

- ◆ Each cassette lasts twice as long
- ◆ The recording is of a slightly lower quality

To record a cassette... Press the SPEED button on the remote control, until...

In standard play mode SP is displayed.
In long play mode LP is displayed.

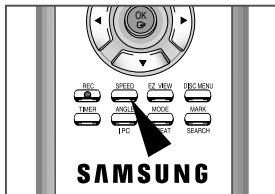

Protecting a Recorded Cassette

VCR

Video cassettes have a safety tab to prevent accidental erasure. When this tab has been removed, you **cannot** record on the tape.

- 1 If you wish to protect a cassette, break off the tab using a small screwdriver.
- 2 To re-record over a protected cassette (safety tab broken), cover the hole with adhesive tape.

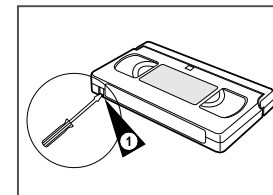

Recording Immediately

VCR

- 1 Switch on the television.
- 2 Press the VCR button.
- 3 Select the recording speed by pressing the SPEED button as many times as required (see page 22).
- 4 Hold REC (●) down for a while to start recording.
Result: The record indicator appears on the television and DVD-VCR display. An index is recorded on the tape (see page 28).
- 5 To stop recording, press ■ once.

- ◆ If your DVD-VCR ejects the cassette when you start recording, check to make sure that the cassette's safety tab is intact or that the opening (created by a broken safety tab) is covered with adhesive tape.
- ◆ If you reach the end of the tape while recording, the cassette rewinds automatically.

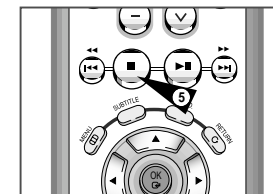
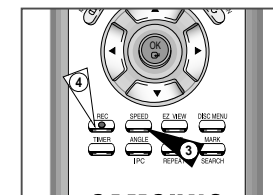
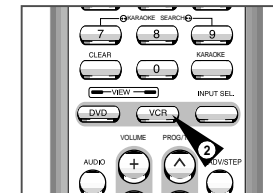

VCR Recording a Programme with Automatic Stop

This function enables you to record up to nine hours (LP) of programmes.

Your DVD-VCR stops automatically after the requested length of time.

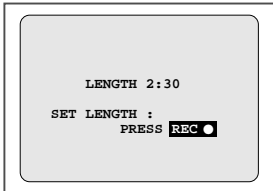
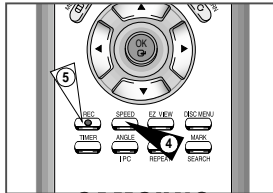
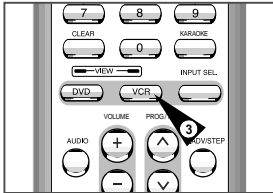
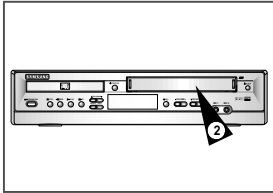

- 1 Switch on the television.
- 2 Insert the cassette on which the programme is to be recorded, with the window visible and the safety tab intact or the opening covered with adhesive tape.
Result: The DVD-VCR is switched on automatically.
- 3 Press the VCR button.
- 4 Select the recording speed by pressing the SPEED button as many times as required (see page 22).
- 5 Hold the REC button (●) down for a while to start recording.
Result: The record indicator appears on the television screen and DVD-VCR display. An index is recorded on the tape (see page 28).
- 6 Press the REC button (●) several times to increase the recording time in:
 - ◆ 30-minute intervals up to four hours
 - ◆ 1-hour intervals up to nine hours**Result:** The length is displayed on the television displays. The selected programme is recorded for the length of time requested. At the end of that time, the DVD-VCR stops recording automatically and power off.
- 7 If you wish to cancel the recording before the end, press STANDBY/ON.

- ☞ If the end of the tape is reached while recording:
- ◆ The recording stops and power off.

Playing a Cassette

This function allows you to play back any pre-recorded cassette.

- 1 Switch on both the television and your DVD-VCR.
- 2 Insert the video cassette to be played. If the safety tab on the cassette is intact, press ►II. Otherwise, the cassette is played automatically.
 - When a cassette is loaded, the tape position is optimized automatically to reduce disturbance (Digital Auto Tracking). When playing a cassette, if the end of the tape is reached, the cassette is rewound automatically.
- 3

To...	Then press...
Stop the playback	■ (STOP).
Eject the cassette	▲ (EJECT).

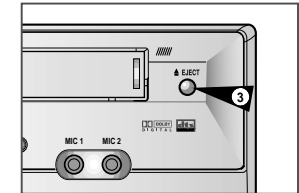
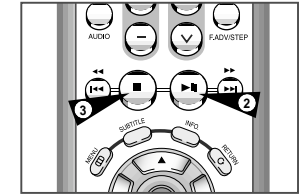

Adjusting Picture Alignment Manually

The Picture Adjustment feature allows you to adjust the alignment manually to obtain the best possible picture.

When noise bars or streaks appear during playback, adjust alignment manually by pressing the TRK (▲ or ▼) buttons until the picture is clear and stable.

- Result:**
- ◆ The tracking bar appears.
 - ◆ The image is adjusted.
 - ◆ The tracking bar disappears when you release the button.

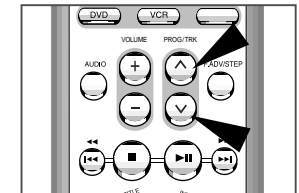

VCR Selecting the Audio Output Mode

You can select the mode in which the sound is reproduced on the loudspeakers and AV outputs. The following options are available.

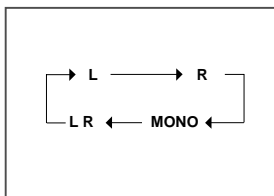
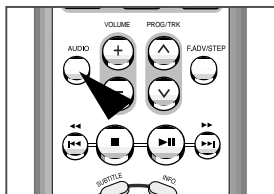

Option	Description
L	Used to listen to the sound on the left Hi-Fi channel.
R	Used to listen to the sound on the right Hi-Fi channel.
MONO	Used to listen to the sound on the normal mono channel.
L R	Used to listen to Hi-Fi stereo sound on the left and right channels. ➤ When playing back tapes recorded in Hi-Fi, the sound switches to Hi-Fi after five seconds of Mono.

To select the sound mode, simply press the AUDIO button on the remote control until the required option is displayed.

VCR Playing a Cassette in Slow Motion

You can play a cassette in slow motion.

- No sound is heard when playing back a cassette in slow motion.

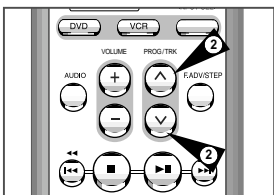
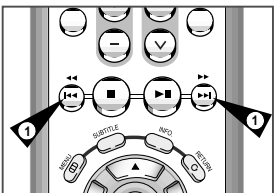

- Press:
 - ◆ ►II to start playing the cassette
 - ◆ ►II button one more time to make still mode.
 - ◆ ►► to start SLOW mode.
 - ◆ ►► or ◀◀ button as many times as required to decrease or increase the speed respectively
 - ◆ To return to the normal speed, press the ►II button twice.
- When playing back in slow motion, picture interference may occur. Press the TRK (▲ or ▼) buttons to minimize this effect.

➡ When you have been using the Slow Motion function for more than about two minutes, the DVD-VCR will automatically play to protect the:

- ◆ Cassette
- ◆ Video heads

Playing a Sequence Frame by Frame

You can:

- ◆ Stop the cassette at a given frame (image)
- ◆ Advance one frame at a time

- No sound is heard when playing back frame by frame.

- Press:
 - ◆ ►II to start playing the cassette
 - ◆ ►II button one more time to make still mode.
 - ◆ F.ADV/STEP to advance frame by frame

- To return to normal playback, press ►II.

- Vertical stability: When playing back frame by frame, interference may be seen on the screen. Press the TRK (▲ or ▼) buttons to minimize this effect.



Playing a Sequence at Variable Speeds

You can vary the playback speed using the Shuttle function (up to nine times the normal speed).

Example: You wish to analyze a sportsperson's technique, movement by movement.

The Shuttle function is available on the Remote control

- No sound is heard when playing a sequence at variable speeds.

- Press:
 - ◆ ►II during playback
 - ◆ SHUTTLE (◀◀) to play the cassette backwards
 - ◆ SHUTTLE (▶▶) to play the cassette forwards

- Each time you press a SHUTTLE button, the speed is changed as shown in the following illustration.

REVERSE PLAY X9	REVERSE PLAY X5	REVERSE PLAY X3	STILL	SLOW MOTION X1/10	SLOW MOTION X1/5	PLAY X3	PLAY X5	PLAY X9
-----------------	-----------------	-----------------	-------	-------------------	------------------	---------	---------	---------

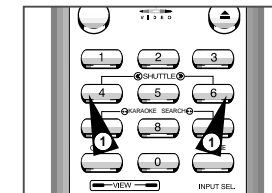

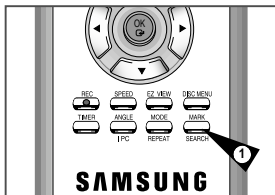

Each time you record a cassette on this DVD-VCR, an "index" is automatically marked on the tape when recording starts. The Search function allows you to fast-forward or rewind to a specific index and start playback from that point. Depending on the direction selected, the indexes are numbered as follows:

		↓			
	Prev	Seq. being	Next		
etc.	Seq.	played	Seq.	etc.	
2	1	1	2		

➤ This DVD-VCR uses a standard indexing system (VISS). As a result, it will recognize any indexes marked by other VCRs using the same system and vice versa.

Go To 0:00:00 Stop

Use this feature when you want to search for the 0:00:00 counter position on a cassette. Press the CLEAR button at the point on the tape where you want to set the counter to 0:00:00. The VCR will rewind or fast forward, searching for the 0:00:00 counter position, and then automatically stop at that position.

- 1 After pressing the SEARCH, press the corresponding ▲ or ▼ buttons, until the Go To (0:00:00) option is selected.
- 2 Press the OK or ►.

End Search

Use this feature when you want to search for a blank position to record a program on a cassette. The VCR will fast forward, searching for a blank position, and then automatically stop at that position. If the VCR reaches the end of the tape during end search, the tape will be ejected.

- 1 After pressing the SEARCH, press the corresponding ▲ or ▼ buttons, until the End Search option is selected.
- 2 Press the OK or ►.

Intro Scan

- 1 After pressing the SEARCH, press the corresponding ▲ or ▼ buttons, until the Intro Scan option is selected.
- 2 Press the OK or ►.
- 3 Press the ◀◀ or ▶▶ buttons depending on the direction where your desired programme is located.
- 4 When an Index mark is found the DVD-VCR will playback the tape for 5 seconds, after which it will continue searching for the next Index mark.
- 5 If you want to watch the tape from a particular Index, simply press ►||.

Index Skip Search:

This feature will enable you to fast forward/rewind to a specific point on a tape: E.g. if you have recorded 3 different programmes on a tape and you have rewound the tape to the beginning, by using this feature you can go directly to the start of programme 2 simply by pressing the SEARCH button.

- 1 After pressing the SEARCH, press the corresponding ▲ or ▼ buttons, until the Intro Scan option is selected.
- 2 Press the OK or ►.
- 3 Press the ◀◀ or ▶▶ buttons twice more. This will take you directly to the start of the desired programme is located.
- 4 These Index searches can be made forwards: (press ▶▶) or backwards: (press ◀◀). (◀◀-20 • • 0 • • +20 ▶▶)
- 5 To cancel an Index search simply press the ►|| or ■ button.

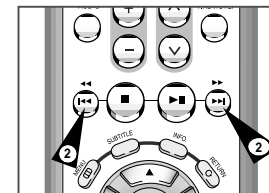
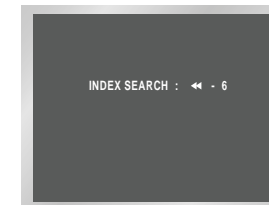
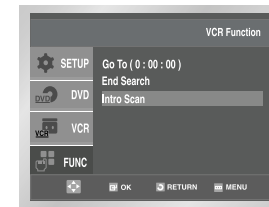

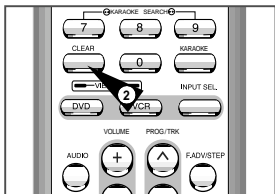
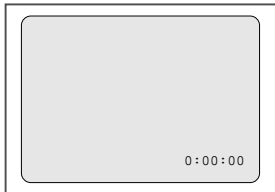

The tape counter:

- ◆ Indicates the elapsed time in the play and record modes (hours, minutes and seconds)
- ◆ Is reset when a cassette is inserted in the DVD-VCR
- ◆ Allows you to find the beginning of a sequence easily

☞ If the remaining time is to be calculated correctly, you must indicate the type of cassette being used.

- 1 Insert a cassette in your DVD-VCR.

- 2 To set the tape counter to zero at the beginning of a sequence:
 - ◆ Press INFO. twice to display the counter
 - ◆ Press CLEAR when you want to set the tape counter to zero

- 3 When you are ready,
 - ◆ Start playback or Recording.
 - ◆ Press the **■** button.
 - ◆ To fast-forward or rewind to the sequence at which the counter was set to zero, press ◀ or ▶.

➤ Some DVD-VCR information, such as the counter, can be displayed on the television screen (unless you have deactivated the Screen messages mode; refer to page 20).

Press INFO.:

- ◆ Once to display the current function, programme number, recording speed, date, time and counter
- ◆ Twice to display the counter only
- ◆ Three times to display the time remaining on the cassette
- ◆ Four times to clear the display



You can connect other audio/video equipment to your DVD-VCR using audio/video cables if the appropriate outputs are available on the equipment chosen.

Examples:

- ◆ You wish to copy a video cassette with the help of a second VCR .
- ◆ You wish to play back and/or copy pictures taken with a camcorder .

☞ Make sure that both the television and the DVD-VCR are switched **off** before connecting the cables.

- 1 Connect one end of the RCA audio/video cable into the VIDEO INPUT socket on the rear of the DVD-VCR.

- 2 Plug the other end of the audio/video cable into the appropriate output connector on the other system (VCR or camcorder).

- 3 Connect one end of the RCA audio cable supplied into the AUDIO INPUT sockets on the rear of the DVD-VCR.
 - Take care to respect the colour coding of the left and right channels.

- 4 Plug the other end of the audio cable into the appropriate output connectors on the other system (VCR, camcorder or Hi-Fi sound system).

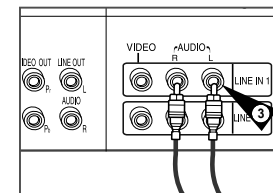
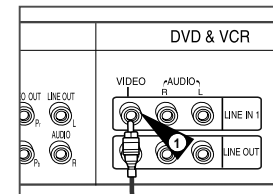

VCR Using the Assemble Edit Function

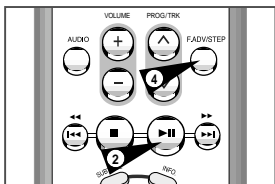

This function allows you to start a new recording at a specific position on the cassette while maintaining a very smooth scene change.

- 1 Insert the cassette to be edited in your DVD-VCR.
- 2 Press the ►|| button to start playback.
- 3 When you reach the position from which you wish to start the new recording, press the ►|| button.
- 4 Press the F.ADV/STEP button again as often as necessary to advance frame by frame, until the exact recording position is located.
- 5 While the DVD-VCR is in still mode, hold the REC button (●) down for a while to activate the Assemble Edit function.
- 6 Press the ►|| button to start recording.
- 7 When you have finished recording, press ■.

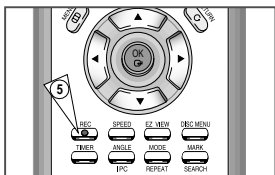

VCR Recoding from Another VCR or Camcorder

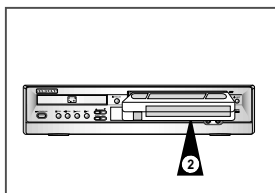

You can copy a cassette to your DVD-VCR from another video source, such as another VCR or a camcorder.

It is an infringement of copyright laws to copy prerecorded cassettes or to re-record them in any form without the permission of the owners of the corresponding copyright.

- 1 Connect the DVD-VCR, from which the cassette is to be copied, to the appropriate RCA audio and video input connectors on the rear of your DVD-VCR, as indicated on page 11.
- 2 Insert a blank cassette in your DVD-VCR.
- 3 Insert the pre-recorded cassette in the other video source (VCR or camcorder).
- 4 Press the INPUT SEL. button to select the appropriate input on your DVD-VCR: LINE IN for the RCA input.
- 5 Start playing back the cassette to be copied.
- 6 Hold REC (●) down for a while to start recording on your DVD-VCR.
- 7 When you have finished recording, press ■ on both VCR and DVD-VCR.

➤ If you wish to view the cassette being copied:

- ◆ Your DVD-VCR must be connected as usual to the television (see page 11 for further details)

Using the KARAOKE Function

- 1 Press the STANDBY/ON button and insert KARAOKE tape.
- 2 Connect Mic into MIC1 or MIC2 jack. Then the KARAOKE mode is transferred "ON" mode.
 - ◆ Disconnect the Mic makes the KARAOKE mode transfer to "OFF" mode automatically.
 - ◆ Press the KARAOKE button on the remote control. Press the ◀ or ▶ button to select KARAOKE mode "ON".
- 3 To adjust the Mic volume and ECHO level, press the VOLUME and ECHO ▲ or ▼ keys front panel.
- 4 To sing with accompaniment.

SCORE Function

- 1 Press the KARAOKE button on the remote control.
- 2 Press the corresponding ▲ or ▼ buttons to select the SCORE mode.
- 3 Press the ◀ or ▶ buttons to select the SCORE mode "ON".
- 4 Score will pop up whenever a song is completed.

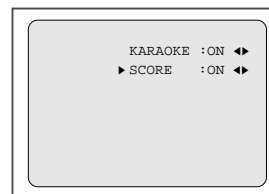

KARAOKE SEARCH Function

- 1 Press the STANDBY/ON button and insert KARAOKE tape.
- 2 Press the KARAOKE button to turn the KARAOKE mode ON.
- 3 Press ►|| to start playing the cassette.
- 4 When you want the next song during playing a song, press the KARAOKE SEARCH ► or KARAOKE SEARCH ◀ buttons on the remote control.

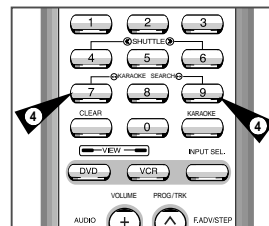

The following show examples of connections commonly used to connect the DVD -VCR player with a TV and other components. It is only available for DVD. The VCR out can not watch by this connection.

Connection to an Audio System

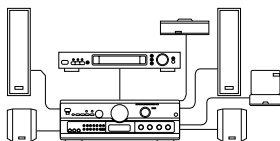

Dolby Digital Decoder
Digital Audio Input Jack



Digital Audio out
Jack

Connection to an Television

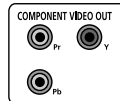
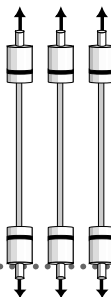
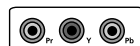

RCA Jack



S-VIDEO OUT

S-Video
Jack

DVD-VCR

If you set the player menu, disc menu, audio and subtitle language in advance, they will come up automatically every time you watch a movie.

Using the Disc Menu Language

This function changes the text language only on the disc menu screens.

- 1 With the unit in Stop mode, press the MENU button.
- 2 Select **DVD** using ▲, ▼ buttons, then OK or ► button
- 3 Select **Language Setup** using ▲, ▼ buttons, then press the OK or ► button.
- 4 Select **Disc Menu** using ▲, ▼ buttons, then press the OK or ► button.
- 5 Use the ▲, ▼ buttons to select '**English**'.
- Select "Others" if the language you want is not listed.
- 6 Press the OK button.
- English is selected and the screen returns to DVD menu.

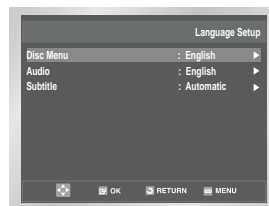

Using the Audio Language

- 1 With the unit in Stop mode, press the MENU button.
- 2 Select DVD using ▲, ▼ buttons, then OK or ► button.
- 3 Select **Language Setup** using ▲, ▼ buttons, then press the OK or ► button.
- 4 Select **Audio** using ▲, ▼ buttons, then press the OK or ► button.
- 5 Press the ▲, ▼ buttons to select 'English'.
 - Select "Original" if you want the default soundtrack language to be the original language the disc is recorded in.
 - Select "Others" if the language you want is not listed.
- 6 Press the OK button.
 - English is selected and the screen returns to DVD menu.

Using the Subtitle Language

- 1 With the unit in Stop mode, press the MENU button.
- 2 Select DVD using ▲, ▼ buttons, then OK or ► button.
- 3 Select **Language Setup** using ▲, ▼ buttons, then press the OK or ► button.
- 4 Select **Subtitle** using ▲, ▼ buttons, then press the OK or ► button.
- 5 Use the ▲, ▼ buttons to select 'English'.
 - Select "Automatic" if you want the subtitle language to be the same as the language selected as the audio preference.
 - Select "Others" if the language you want is not listed.
 - Some discs may not contain the language you select as your initial language; in that case the disc will use its original language setting.
- 6 Press the OK button.
 - English is selected and the screen returns to DVD menu.

- 1 With the unit in Stop mode, press the MENU button.
- 2 Select DVD using ▲, ▼ buttons, then OK or ► button.
- 3 Select **Audio Setup** using ▲, ▼ buttons, then press the OK or ► button.
- 4 Use the ▲, ▼ buttons to select the desired item. Then press the OK or ► button.

• **Dolby Digital Out**

1. **PCM:**
Converts to PCM(2CH) audio.
Select PCM when using the Analog Audio Outputs.
2. **Bitstream :**
Converts to Dolby Digital Bitstream (5.1CH).
Select Bitstream when using the Digital Audio Output.

➤ • *Be sure to select the correct Digital Output or no audio will be heard.*

• **MPEG-2 Digital Out**

1. **PCM :** Converts to PCM(2CH) audio.
Select PCM when using the Analog Audio Outputs.
2. **Bitstream :** Converts to MPEG-2 Digital Bitstream (5.1CH or 7.1CH). Select Bitstream when using the Digital Audio Output.

• **DTS**

1. **Off :** Doesn't output digital signal.
2. **On :** Outputs DTS Bitstream via digital output only.
Select DTS when connecting to a DTS Decoder.

• **Dynamic Compression**

1. **On :** To select dynamic compression.
2. **Off :** To select the standard range.

• **PCM Down Sampling**

1. **On :** Select this when the amplifier connected to the player is not 96KHz compatible.
In this case, the 96KHz signals will be down converted to 48KHz.
2. **Off :** Select this when the amplifier connected to the player is 96KHz compatible.
In this case, all signals will be output without any changes.

➤ • *How to make the SETUP menu disappear or return to menu screen during set up; Press RETURN or ◀ button.*

• *Manufactured under license from Dolby Laboratories.*

• *"Dolby" and the double-D symbol are trademarks of Dolby Laboratories.*

• *"DTS" and "DTS Digital Out" are trademarks of Digital Theater Systems, Inc.*

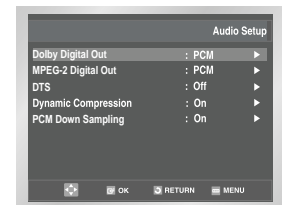
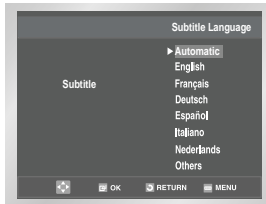
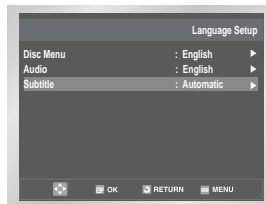
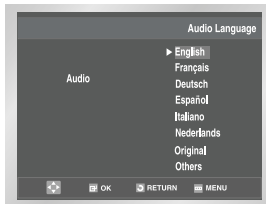
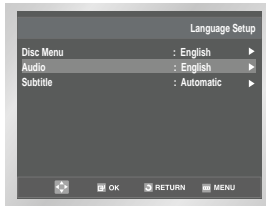

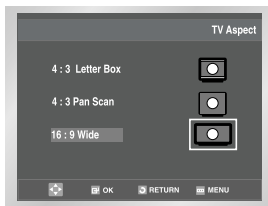
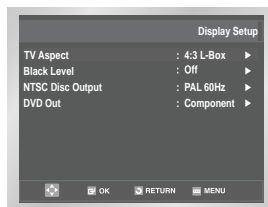

- 1 With the unit in Stop mode, press the MENU button.
- 2 Select DVD using ▲, ▼ buttons, then OK or ► button.
- 3 Select **Display Setup** using ▲, ▼ buttons, then press the OK or ► button.
- 4 Use the ▲, ▼ buttons to select the desired item. Then press the OK or ► button.

TV Aspect

Depending on the type of television you have, you may want to adjust the screen setting (aspect ratio).

1. 4:3 Letter Box :

Select when you want to see the total 16:9 ratio screen DVD supplies, even though you have a TV with a 4:3 ratio screen. Black bars will appear at the top and bottom of the screen.

2. 4:3 Pan Scan :

Select this for conventional size TVs when you want to see the central portion of the 16:9 screen. (Extreme left and right side of movie picture will be cut off.)

3. 16:9 Wide :

You can view the full 16:9 picture on your widescreen TV.

Black Level

Adjusts the brightness of the screen.(On/Off)

NTSC Disc Output

“NTSC” if the screen only has one NTSC-video entrance. If this is not the case, you can choose to leave “ PAL 60Hz” as is.

DVD Out

Component : Sends COMPONENT signal (Y, Pb, Pr) to the component video out JACK.

S-Video : Sends S-VIDEO signal to the S-VIDEO OUT JACK.

Video : Sends COMPOSITE VIDEO signal to the Scart JACK.



The Parental Control function works in conjunction with DVDs that have been assigned a rating - which helps you control the types of DVDs that your family watches. There are up to 8 rating levels on a disc.

- 1 With the unit in Stop mode, press the MENU button.
- 2 Select DVD using ▲, ▼ buttons, then OK or ► button.
- 3 Select **Parental Setup** using ▲, ▼ buttons, then press the OK or ► button.
- 4 Use OK or ► to select **Yes** if you want to use a password. The **Enter Password** screen appears.
- 5 Enter your password. The **Re-Enter Password** screen appears to confirm the password. Ok your password again. The Parental Control screen appears.

• About the Rating Level ;

The Rating Level will work only when **Use Password** is set to Yes. To unlock the player, use ▲, ▼ to select No. Use OK or ► to select **Rating Level**. Press OK.
 - Use ▲, ▼ to select the level(e.g. Level 6) and press OK. Discs that contain Level 7 will now not play.
 - To cancel the rating level, use OK or ► to select No in Use Password.

• About the Change Password ;

- Use ▲, ▼ to select Change Password.
 Press OK. The Change Password screen appears.
 - Ok your new password. Re-ok the new password again.

- **• How to make the SETUP menu disappear or return to menu screen during set up; Press RETURN or ◀ button.**
• If you have forgotten your password, see Forget Password in the Troubleshooting Guide. (See page 59)

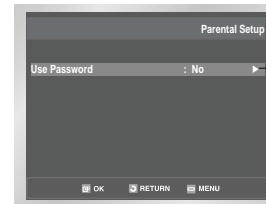

No
Yes

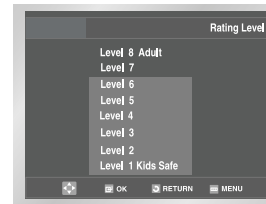
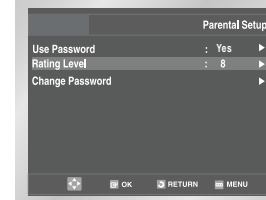
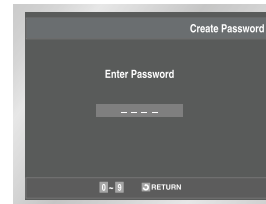

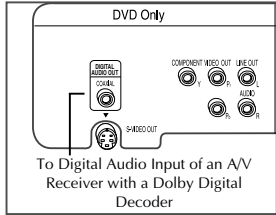

To take full advantage of the movie theater experience that DVD offers, you may want to connect your DVD-VCR to a complete Surround Sound system, including an A/V Receiver and six Surround Sound speakers.

Before You Begin...

- If your A/V receiver is equipped with a Dolby Digital Decoder, you have the option to bypass the DVD-VCR's built-in Dolby Digital Decoder. Use the DIGITAL AUDIO OUT connection below.

1 Digital Audio Out

Connect a digital coaxial cable from the DIGITAL AUDIO OUT jacks on the back panel of the DVD-VCR to their corresponding Digital Audio Input jacks on your A/V Receiver:

- Coaxial
- Use whichever connection is available on your A/V Receiver.

During DVD/CD playback you can select from the following special playback options. To resume normal playback, press the ►|| (Play/Still) button.

1 Still

Press the ►|| (Play/Still) button on the remote control during playback.

- The picture will still and the audio will mute.
- To resume playback, press the ►|| (Play/Still) button.
- If the player is left in Still mode for 5 minutes, it will stop automatically.

2 Frame Advance (Step)

While in playback mode, press the F.ADV/STEP button on the remote control to advance one frame at a time.

- Audio is muted during Frame Advance mode.
 - Press ►|| (Play/Still) to resume normal playback.
- NOTE: Frame Advance operates only in the forward direction.

3 Skip Forward/Back

While a CD or DVD disc is in Play mode, press the Skip Forward/Back (►| / |◄◄) buttons on the remote control or front panel to jump forward and backward through disc chapters/tracks.

- Skip Forward will jump to the next chapter/track.
- Skip Back will jump to the beginning of the current chapter/track.
- Press Skip Back again to jump to the beginning of the previous chapter/track.

Search Forward/Back

While a disc is in Play mode, press and hold the Forward/Back (►► / ◄◄) buttons on the remote control or front panel to visually search forward/backward at 2X - 4X - 8X - 16X - 32X - 128X speed. Press ►|| (Play/Still) button to resume normal speed.

4 Slow Motion

During playback, press the ►|| (Play/Still) button to Still the image. Then use the Search Forward (►►) to play in slow motion at variable speeds.

- Each press increases the slow motion speed playback to 1/8, 1/4 or 1/2 normal speed.
- Audio is muted during slow motion playback.

5 Stop/Resume

- Press the Stop button once to stop playback. To resume the DVD/CD from the point where the disc stopped, press the ►|| (Play/Still) button.
- Press the ■ (Stop) button twice to completely stop playback. The next time you press ►|| (Play/Still), the disc will start over from the beginning.

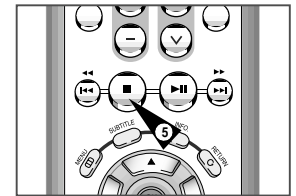
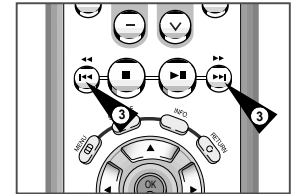
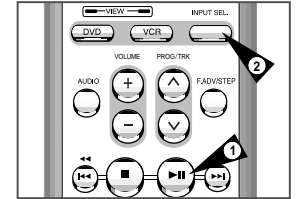

To play back using aspect ratio (DVD)

- 1 Press the EZ VIEW button.
 - The screen size changes when the button is pressed repeatedly.
 - The screen zoom mode operates differently depending on the screen setting in the initial DVD menu.
 - To ensure correct operation of the EZ VIEW button, you should set the correct aspect ratio in the initial setup (See page 50).

If you are using a 16:9 TV**For 16:9 aspect ratio discs**

- **Wide Screen**
Displays the content of the DVD title in 16:9 aspect ratio.
- **Screen Fit**
The top and bottom of the screen are cut off. When playing a 2.35:1 aspect ratio disc, the black bars at the top and bottom of the screen will disappear. The picture will look vertically stretched. (Depending on the type of disc, the black bars may not disappear completely.)
- **Zoom Fit**
The top, bottom, left and right of the screen are cut off and the central portion of the screen is enlarged.

For 4:3 aspect ratio discs

- **Normal Wide**
Displays the content of the DVD title in 16:9 aspect ratio. The picture will look horizontally stretched.
- **Screen Fit**
The top and bottom of the screen are cut off and the full screen appears. The picture will look vertically stretched.
- **Zoom Fit**
The top, bottom, left and right of the screen are cut off and the central portion of the screen is enlarged.
- **Vertical Fit**
When a 4:3 DVD is viewed on a 16:9 TV, black bars will appear at the left and right of the screen in order to prevent the picture from looking horizontally stretched.

If you are using a 4:3 TV**For 16:9 aspect ratio discs**

- **4:3 Letter Box**
Displays the content of the DVD title in 16:9 aspect ratio. The black bars will appear at the top and bottom of the screen.
- **4:3 Pan Scan**
The left and right of the screen are cut off and displays the central portion of the 16:9 screen.
- **Screen Fit**
The top and bottom of the screen are cut off and the full screen appears. The picture will look vertically stretched.
- **Zoom Fit**
When a 4:3 DVD is viewed on a 16:9 TV, black bars will appear at the left and right of the screen in order to prevent the picture from looking horizontally stretched.

For 4:3 aspect ratio discs

- **Normal Screen**
Displays the content of the DVD title in 4:3 aspect ratio.
- **Screen Fit**
The top and bottom of the screen are cut off and the full screen appears. The picture would look vertically stretched.
- **Zoom Fit**
The top, bottom, left and right of the screen are cut off and the central portion of the screen is enlarged.

➤ *• This function may behave differently depending on the type of disc.*

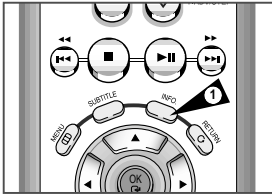

When Playing a DVD/VCD/CD

- 1 During play, press the INFO. button on the remote.
- 2 Use the ▲, ▼ buttons to select the desired item.
- 3 Use the ◀, ▶ buttons to make the desired setup.
 - You may use the number buttons of the remote control to directly access a title, chapter or to start the playback from the desired time.
- 4 To make the screen disappear, press the INFO. button again.

- **What is a Chapter?**
 Each Title on a DVD is usually divided into chapters (similar to tracks on an audio CD).
- **What is a Title?**
 A DVD may contain several different titles. For example, if a disc contains four different movies, each might be considered a title.

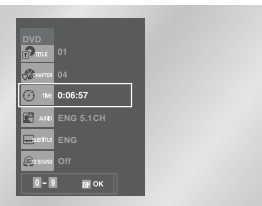
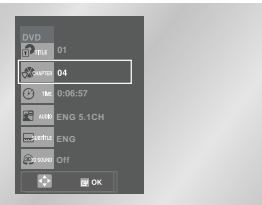
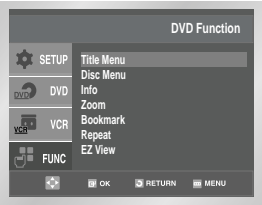

- TITLE** To access the desired title when there is more than one in the disc. For example, if there is more than one movie on a DVD, each movie will be identified.
- CHAPTER** Most of DVD discs are recorded in chapters so that you can quickly find a specific passage.
- TIME** Allows playback of the film from a desired time. You must ok the starting time as a reference.
- AUDIO** Refers to the language of the film soundtrack. In the example, the soundtrack is played in English 5.1CH. A DVD disc can have up to eight different soundtracks.
- SUBTITLE** Refers to the subtitle languages available in the disc. You will be able to choose the subtitles language or, if you prefer, turn them off from the screen. A DVD disc can have up to 32 different subtitles.
- 3D SOUND** A surround sound effect is generated using only two front speakers.

* When in VCD 2.0 mode (MENU ON mode), this function does not work.

Using the ANGLE button

When a DVD contains multiple angles of a particular scene, you can select the Angle function.

Press the ANGLE button to see if an ANGLE () mark is present at the upper Right hand corner of the screen.

- 1 When an ANGLE mark is shown, press the ANGLE button, then an ANGLE select icon will appear at the upper left hand corner of the screen.
- 2 Use the ◀, ▶ buttons to select the desired screen angle.
- 3 To turn off the display, press the ANGLE button again.

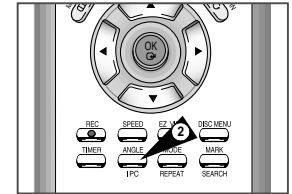

Selecting the Subtitle Language

You can select a desired subtitle quickly and easily with the subtitle button.

Using the SUBTITLE button

- 1 Press the SUBTITLE button.
 - 2 Use the ◀, ▶ buttons to select the desired subtitle language.
 - 3 Use the ▲, ▼ buttons to determine whether or not the subtitle will be displayed.
 - Initially, the subtitling will not appear on screen.
 - The subtitle languages are represented by abbreviations.
-
- This function depends on what languages are encoded on the disc and may not work with all DVDs.
 - A DVD disc can contain up to 32 subtitle languages.
 - How to have the same subtitle language come up whenever you play a DVD; Refer to "Setting Up the Language Features" on page 35.

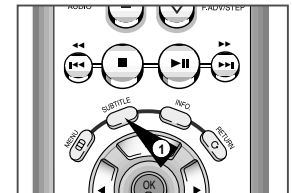

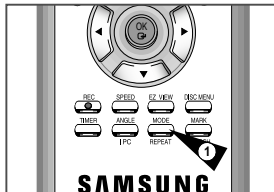

DVD

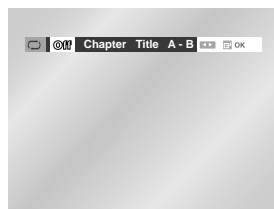

VCD / CD

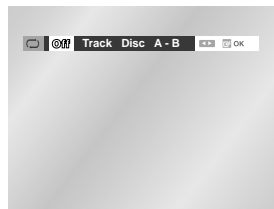

Repeat the current track, chapter, title, a chosen section (A-B), or all of the disc.

When playing a DVD

- 1 Press the REPEAT button on the remote. Repeat screen appears.
- 2 Select Chapter, Title or A-B using the ◀, ▶ buttons.
 - Press the REPEAT button. Select A-B on screen with the ◀, ▶ buttons.
 - Press OK at the point where you want the repeat play to start (A). The B is automatically highlighted.
 - Press OK at the point where you want the repeat play to stop (B).
 - To terminate the function, press the 'CLEAR' button.
 - A-B REPEAT does not allow you to set point (B) until at least 5 seconds has elapsed after point (A) has been set.
- 3 Press OK.
- 4 To return to normal play, press REPEAT again, then press the ◀, ▶ buttons to select Off and press OK.
 - It is available to press CLEAR button on the remote controller in order to stop REPEAT play.

- DVD repeats play by chapter or title, CD and VCD repeat play by disc or track.
- Depending on the disc, the Repeat function may not work.
- When in VCD 2.0 mode (MENU ON mode), this function does not work.

You can select a desired language quickly and easily with the AUDIO button.

Using the AUDIO button

- 1 Press the AUDIO button.
- 2 Use the ◀, ▶ buttons to select the desired language on a DVD. - The audio languages are represented by abbreviations.
- 3 Use the ◀, ▶ buttons to select Stereo, ◀ or ▶ (On VCD/CD)

- This function depends on what languages are encoded on the disc and may not work with all DVDs.
- A DVD disc can contain up to 8 audio languages.
- How to have the same audio language come up whenever you play a DVD ; Refer to "Setting Up the Language Features" on page 35.

DVD



VCD/ CD

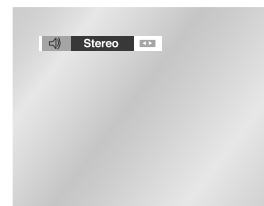

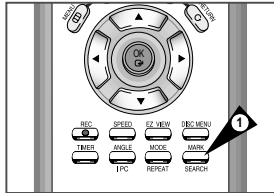

This feature lets you mark sections of a DVD or VCD (MENU OFF mode) so you can quickly find them at a later time.

Using the Mark Function (DVD/VCD)

- 1 During play, press the MARK button on the remote. The Mark icons will be displayed.
- 2 Use the ◀, ▶ buttons to move to the desired Mark icon.
- 3 When you reach the scene you want to mark, press the OK button. The icon will change to a number (1, 2, or 3).
- 4 Press the MARK button to turn off the display.

Recalling a Marked Scene

- 1 During play, press the MARK button on the remote.
- 2 Use the ◀, ▶ buttons to select a marked scene.
- 3 Press the PLAY/STILL (▶||) buttons to skip to the marked scene.

Clearing a Mark

- 1 During play, press the MARK button on the remote.
- 2 Use the ◀, ▶ buttons to select the mark number you want to delete.
- 3 Press the CLEAR button to delete a mark number. Press the MARK button to turn off the display.

- **Up to three scenes may be marked at a time.**
- When in VCD 2.0 mode (MENU ON mode), this function does not work.
- Depending on the disc, the mark function may not work.

When an MP3/WMA Disc is inserted into the DVD player, the first song file of the first folder plays.

- If more than two file extensions are present, select the media of your choice.
- To change the currently playing media, press the STOP (■) button twice and then press the DISC MENU button.
- If no button on the remote controller is pressed for 60 seconds, the menu will disappear and the selected item will be played.

MP3/WMA Play Function

- 1 When the first song file is playing, the music folder menu will appear on the right side of the screen. Up to 8 music folders can be displayed at a time. If you have more than 8 folders on a disc, press the ◀, ▶ buttons to bring them up on the screen.
- 2 Use the ▲, ▼ buttons to select the desired music folder, then press OK. Use the ▲, ▼ buttons again to select a song file. Press OK to begin playback of the song file.

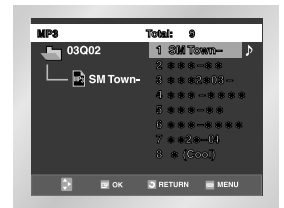
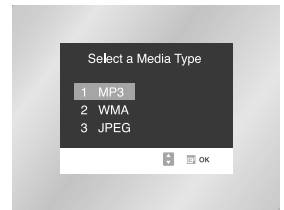

Program/Random playback

1. Press the MODE button in STOP mode to switch between the RANDOM and PROGRAM modes.

- **Press the REPEAT button in Play mode to hear only music continuously and press it once again to release.**
- PROGRAM/RANDOM playback cannot be used if the disc contains more than two types of file extensions.

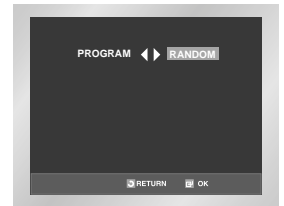

MP3/WMA Play

CD-R MP3/WMA discs

When playing CD-R/MP3 or WMA discs, please follow all the recommendations for CD-R above, plus the comments below:

- **Your MP3 or WMA files should be ISO 9660 or JOLIET format.**

ISO 9660 format and Joliet MP3 or WMA files are compatible with Microsoft's DOS and Windows, and with Apple's Mac. These two formats are the most widely used.

- **When naming your MP3 or WMA files do not exceed 8 characters, and place ".mp3, .wma" as the file extension.**

General name format of: Title.mp3. or Title.wma. When composing your title, make sure that you use 8 characters or less, have no spaces in the name, and avoid the use of special characters including: (,./, \, =, +).

- **Use a decompression transfer rate of at least 128 Kbps when recording MP3 files.**

Sound quality with MP3 files basically depends on the rate of compression/decompression you choose. Getting audio CD quality sound requires an analog/digital sampling rate, that is conversion to MP3 format, of at least 128 Kbps and up to 160 Kbps. However, choosing higher rates, like 192 Kbps or more, only rarely give better sound quality.

Conversely, files with decompression rates below 128 Kbps will not be played properly.

- **Use a decompression transfer rate of at least 64Kbps when recording WMA files.**

Sound quality with WMA files basically depends on the rate of compression/decompression you choose. Getting audio CD quality sound requires an analog/digital sampling rate, that is conversion to WMA format, of at least 64Kbps and up to 192Kbps.

Conversely, files with decompression rates below 64Kbps or over 192Kbps will not be played properly.

- **Do not try recording copyright protected MP3 files.**

Certain "securized" files are encrypted and code protected to prevent illegal copying. These files are of the following types: Windows Media™ (registered trade mark of Microsoft Inc) and SDMI™ (registered trade mark of The SDMI Foundation). You cannot copy such files.

- **Important:** The above recommendations cannot be taken as a guarantee that the DVD player will play MP3 recordings, or as an assurance of sound quality.

You should note that certain technologies and methods for MP3 file recording on CD-Rs prevent optimal playback of these files on your DVD player (degraded sound quality and in some cases, inability of the player to read the files).

- This unit can play a maximum of 500 files and 300 folders per disc.

Program Play & Random Play

Program Play (CD/MP3/WMA)

1. Press the MODE button.
2. Use the ◀, ▶ buttons to select PROGRAM. Press the OK button.
3. Use the ▲, ▼ / ◀, ▶ buttons to select the first track to add to the program. Press the OK button. The selection numbers appear in the Program Order box.
4. Press the PLAY/STILL (▶||) button. The disc will be played in programmed order.

Random Play (CD/MP3/WMA)

1. Press the MODE button.
2. Use the ◀, ▶ buttons to select RANDOM. Press the OK button. The disc will be played in random order.



- *Depending on the disc, the Program and Random Play functions may not work.*
- *To resume normal play, press the CLEAR button.*
- *PROGRAM/RANDOM playback cannot be used if the disc contains more than two types of file extensions.*
- *This unit can support a maximum of 99 programmed order.*

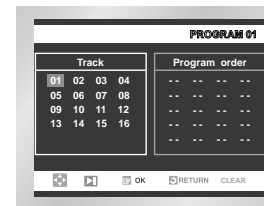

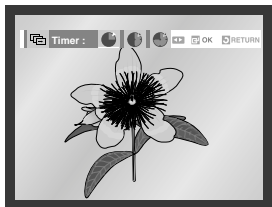
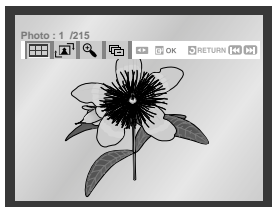
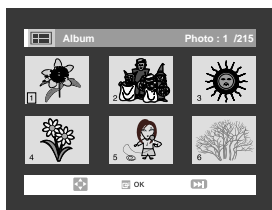
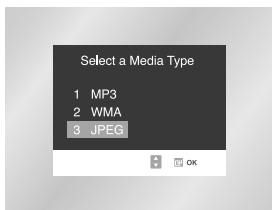

- Select JPEG in the menu to view a Photo CD.
- To change the currently playing media, press the STOP (■) button twice and then press the DISC MENU button.
- If no button on the remote controller is pressed for 60 seconds, the menu will disappear and the selected item will be played.

1. Open the disc tray.
2. Load the disc on the tray.
Load the disc with the labeled side up.
3. Close the tray.
- The tray closes and you should get a screen that looks like the one below.

- Use the ▲, ▼ or ◀, ▶ buttons on the remote controller to select the picture you want to view and then press the OK button. (Press the PLAY/STILL (▶||) button if you want to play it in the Slide Show mode.)

- To see the next 6 pictures, press the ►► button.
- To see the previous 6 pictures, press the ◀◀ button.

- : Return to the Album Screen.
- : Each time the OK button is pressed, the picture rotates 90 degrees clockwise.
- : Each time the OK button is pressed, the picture is enlarged up to 2X. (Normal → 2X → Normal)
- : The unit enters slide show mode.

*Press the RETURN button to return to the album screen.
*Before the Slide Show can begin, the picture interval must be set.

- : When this icon is selected and OK is pressed, the pictures change automatically with about a 6 second interval.
- : The pictures change automatically with about an 12 second interval.
- : The pictures change automatically with about an 18 second interval.

*Depending on the file size, each interval between images may take longer or shorter than the manual suggests.

CD-R JPEG Discs

- Only files with the ".jpg" and ".JPG" extensions can be played.
- If the disc is not closed, it will take longer to start playing and not all of the recorded files may be played.
- Only CD-R discs with JPEG files in ISO 9660 or Joliet format can be played.
- The name of the JPEG file may not be longer than 8 characters and should contain no blank spaces or special characters (. / = +).
- Only a consecutively written multisession disc can be played. If there is a blank segment in the multisession disc, the disc can be played only up to the blank segment.
- A maximum of 500 images can be stored on a single CD.
- Only Kodak Picture CDs can be played.
- When playing a Kodak Picture CD, only the JPEG files in the pictures folder can be played.
- Picture discs other than Kodak Picture CD may take longer to start playing or may not play at all.
- If a number of files in 1 Disc is over 500, only 500 JPEG file can be played.
- If a number of folders in 1 Disc is over 300, only JPEG files in 300 folders can be played.



- When the banner is being appeared, press the RETURN button to return to the album screen.
- If no buttons on the remote controller pressed for 10 seconds, the menu will disappear.
Press the ▲, ▼ or ◀, ▶ buttons on the remote controller to display the menu again.

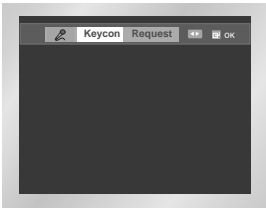

- 1 Connect the Mixed Audio Out terminals with the TV or AMP.
- 2 Press the power button.
- 3 Connect Mic into Mic 1 or Mic 2 jack. Then the karaoke mode is transferred to ON mode.
- To disconnect the Mic makes the karaoke mode transfer to OFF mode automatically.

- ◆ This function operates only in DVD, VCD, and CD DISC.
- ◆ This function cannot operate according to the disc type.

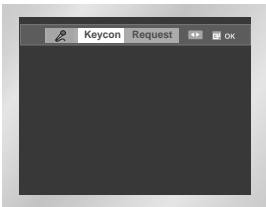

- 1 Select the "Keycon" using the ◀ or ▶ buttons.
- 2 By use of the ◀ or ▶ buttons, change to the desired tone.
- ♭ : To let 7 scales down by half scale.
- ♮ : Original scale.
- # : To let 7 scales up by half scale.

- ◆ Key control function is not applied to the Mic output.
- ◆ Key control function can not work at the VCR

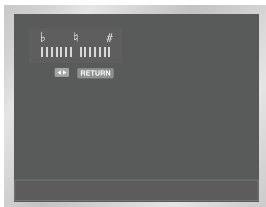

It is the function to reserve the desired song in advance by use of Karaoke function.

- 1 Playback the Karaoke Disc containing the wanted songs.
- 2 After pressing the KARAOKE button of the remote transfer to the KARAOKE ON mode using the ▲ or ▼ buttons.
- 3 Select the "Request" using the ◀ or ▶ buttons, then press OK button.
- 4 Input the number (Track No.) of the desired song into the flickering part(-).
- You can reserve up to 10 songs.
- 5 When you want the next reserved song during playing a song, press the ▶▶ button.

- ◆ When the Request is ended, the mode changes to STOP mode.

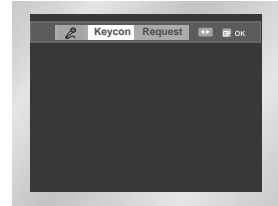

- 1 Cancel by pressing the CLEAR button of the remote.
- The last reserved song will be erased first.
- 2 Continuous pressing of the CLEAR button can cancel the next reserved song.
- 3 If the reservation is required again, input the song number in the flickering part.

- ◆ Request function is available only when the Karaoke mode is "ON".
- ◆ When using "▶▶" button, it can not work at the last song.
- ◆ When using Request function, the "REPEAT" function does not work.

KARAOKE Vocal Fader

Pressing the KARAOKE button twice displays the following in Karaoke ON mode:

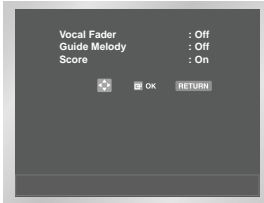

- The function to make the music only sound by cancelling vocal when playing a Karaoke disc.

VOCAL FADER	Remark
V1	CH1. Vocal Cancel
V2	CH2. Vocal Cancel
V1 +V2	CH1, CH2. Vocal Cancel
OFF	Vocal Fader Off

- In VCD, CVD or CD, you can select only the L, R, OFF.

KARAOKE Guide Melody

- ◆ To guide melody through xylophone and piano help you sing easily.
- ◆ This function works only on the DVD Karaoke disc on which the guide melody is recorded.

KARAOKE Score Function

- Press KARAOKE button twice to turn the Score Mode On.
- ◆ Score will pop up whenever a song is completed.

KARAOKE Types of Karaoke disc

◆ DVD Karaoke Disc

Channel	Karaoke Channel	5CH. DVD	2CH. DVD
1 CH	L	Left stereo music	Left stereo music + Vocal
2 CH	R	Right stereo music	Right stereo music + Vocal
3 CH	M	Guide melody	-
4 CH	V1	Vocal track	-
5 CH	V2	Vocal track	-

◆ CVD, VCD Karaoke Disc

Channel	Karaoke Channel	CVD	VCD, CD
1 CH	CH1 LEFT	Left stereo music+Vocal	Left stereo music
1 CH	CH1 RIGHT	Right stereo music+Vocal	Right stereo music + Vocal
2 CH	CH2 LEFT	Left stereo music	-
2 CH	CH2 RIGHT	Right stereo music	-

* It cannot be done as above picture in accordance with the disc type.

CAUTIONS: Make sure to turn the KARAOKE MODE to OFF to play a movie disc or play in a general mode. If you play a movie disc with the KARAOKE ON, a score will show up every time when a chapter is over.

Technical Specifications

General	Rated voltage	110 - 240V~, 50/60Hz
	Power consumption	23 Watts
	Weight	3.8 Kg
	Size	430mm X 265mm X 94mm
	Operating ambient temperature	+5°C ~ +35°C
Input	Installation conditions	Operation position : Horizontal, Relative humidity : Below 75%
	Video input (Rear)	RCA jack : 1.0Vp-p (unbalanced) 75Ω
	Audio input (Rear)	RCA jack : -8dBm, 47Kohm unbalanced
Output	MIC(Front)	
	Audio (DVD, VCR)	RCA jack
	Audio (DVD only)	Digital audio out (COAXIAL)
	Video (DVD, VCR)	RCA jack
VCR	Video (DVD only)	S-Video out COMPONENT out : RCA jack
	Tape format	VHS type video tape, S-VHS type video tape (Playback only)
	Color system	PAL, MESECAM, NT3.58, NTSC4.43, NTSC playback on PAL TV
	Video S/N	Above 43dB (standard recording)
	Resolution	Above 240 lines (standard recording)
	Audio S/N	Above 68dB (Hi-Fi), 39dB (Mono)
DVD	Audio frequency characteristics	20Hz - 20KHz (Hi-Fi)
	Disc	DVD, CD (12cm), CD (8cm), VIDEO-CD (12cm)
	Audio S/N	95dB
	Audio dynamic range	105dB

Before contacting the Samsung after-sales service, perform the following simple checks.

Problem	Explanation/Solution
No power	<ul style="list-style-type: none"> ◆ Check that the power plug is connected to a wall outlet. ◆ Have you pressed the STANDBY/ON button?
You cannot insert a video cassette	<ul style="list-style-type: none"> ◆ A video cassette can only be inserted with the window side up and the safety tab facing you.
No playback picture or the picture is distorted	<ul style="list-style-type: none"> ◆ Check to see if you are using a prerecorded tape.
Noise bars or streaks on playback	<ul style="list-style-type: none"> ◆ Press the TRK (\wedge or \vee) buttons to minimize this effect.
When the $\blacktriangleright\parallel$ button is pressed during playback, the still picture has severe "noise bars" streaks	<ul style="list-style-type: none"> ◆ A still picture may have "noise bars", depending on the condition of the tape. Press the TRK (\wedge or \vee) buttons during SLOW motion to minimize this effect.
Video Head Cleaning	<ul style="list-style-type: none"> ◆ If poor pictures appear on a variety of cassettes, the video heads may need cleaning. This is not a common problem and unless it appears, the heads should not be cleaned. When cleaning the video heads, read all instructions provided with the head cleaning cassette. Incorrect head cleaning can permanently damage the video heads.

If you are unable to solve the problem after reading the above instructions, note:

- ◆ The model and serial number on the rear of your DVD-VCR
- ◆ The warranty information
- ◆ A clear description of the problem

Then contact your nearest SAMSUNG after-sales service.

Before requesting service (troubleshooting)

Problem	Action	Page
Disc does not play.	<ul style="list-style-type: none"> ◆ Ensure that the disc is installed with the label side facing up. ◆ Check the region number of the DVD. ◆ This player cannot play CD-ROMs, DVD-ROMs, etc. Insert a DVD, a VIDEO-CD or a CD. 	P6
5.1 channel sound is not being reproduced.	<ul style="list-style-type: none"> ◆ 5.1 channel sound is reproduced only when the following conditions are met. : 1) The DVD-VCR player is connected with the proper amplifier 2) The disc is recorded with 5.1 channel sound. ◆ Check whether the disc being played has the "Dolby 5.1 ch" mark on the outside. ◆ Check if your audio system is connected and working properly. 	P34 P37
The \odot icon appears on screen.	<ul style="list-style-type: none"> ◆ The features or action cannot be completed at this time because: 1. The DVD's software restricts it. 2. The DVD's software doesn't support the feature (e.g., angles). 3. The feature is not available at the moment. 4. You've requested a title or chapter number or search time that is out of range. 	P35-56
Playback mode differs from the Setup Menu selection.	<ul style="list-style-type: none"> ◆ Some of the functions selected in the Setup Menu may not work properly if the disc is not encoded with the corresponding function. 	P35-39
The screen ratio cannot be changed.	<ul style="list-style-type: none"> ◆ The Screen Ratio is fixed on your DVDs. 	P38
No audio.	<ul style="list-style-type: none"> ◆ Make sure you have selected the correct Digital Output in the Audio Options Menu. 	P37
Forgot password	<ul style="list-style-type: none"> ◆ Press power on from a cold start with no disc in the unit. Press the \blacktriangleright and \blacktriangleleft buttons simultaneously on the front panel for five seconds. Press the MENU button on the remote control to select the Parental Mode. The Parental Mode is now unlocked as indicated on the display. Press the DOWN button to select Parental. Press OK and the Create Password display will appear. You can now set your rating level and change your password to a new number. 	
If you experience other problems.	<ul style="list-style-type: none"> ◆ Go to the contents and find the section of the instruction book that contains the explanations regarding the current problem, and follow the procedure once again. ◆ If the problem still cannot be solved, please contact your nearest authorized service center. 	

THIS APPLIANCE IS DISTRIBUTED BY

