

**ASUS<sup>®</sup> P/I-AP55TV**

All-In-One Pentium Motherboard

**USER'S MANUAL**

# USER'S NOTICE

---

No part of this product, including the product and software may be reproduced, transmitted, transcribed, stored in a retrieval system, or translated into any language in any form by any means without the express written permission of ASUSTeK COMPUTER INC. (hereinafter referred to as ASUS) except documentation kept by the purchaser for backup purposes.

ASUS provides this manual "as is" without warranty of any kind, either express or implied, including but not limited to the implied warranties or conditions of merchantability or fitness for a particular purpose. In no event shall ASUS be liable for any loss or profits, loss of business, loss of use or data, interruption of business, or for indirect, special, incidental, or consequential damages of any kind, even if ASUS has been advised of the possibility of such damages arising from any defect or error in this manual or product. ASUS may revise this manual from time to time without notice.

Products mentioned in this manual are mentioned for identification purposes only. Product names appearing in this manual may or may not be registered trademarks or copyrights of their respective companies.

The product name and revision number are both printed on the board itself. Manual revisions are released for each board design represented by the digit before and after the period of the manual revision number. Manual updates are represented by the third digit in the manual revision number. For updated BIOS, drivers, or product release information you may visit ASUS' home page at: <http://www.asus.com.tw/>

© Copyright 1996 ASUSTeK COMPUTER INC. All rights reserved.

Product Name:	<b>P/I-AP55TV</b>
Manual Revision:	<b>1.20</b>
Release Date:	<b>January 1996</b>

# ASUS CONTACT INFORMATION

---

## ASUSTeK COMPUTER INC.

### *Marketing Info:*

Address: 150 Li-Te Road, Peitou, Taipei, Taiwan, ROC

Telephone: 886-2-894-3447

Fax: 886-2-894-3449

Email: [info@asus.com.tw](mailto:info@asus.com.tw)

### *Technical Support:*

Fax: 886-2-895-9254

BBS: 886-2-896-4667

Email: [tsd@asus.com.tw](mailto:tsd@asus.com.tw)

WWW: <http://www.asus.com.tw/>

Gopher: <gopher.asus.com.tw>

FTP: <ftp.asus.com.tw/pub/ASUS>

## ASUS COMPUTER INTERNATIONAL

### *Marketing Info:*

Address: 721 Charcot Avenue, San Jose, CA 95131, USA

Telephone: 1-408-474-0567

Fax: 1-408-474-0568

Email: [info-usa@asus.com.tw](mailto:info-usa@asus.com.tw)

### *Technical Support:*

BBS: 1-408-474-0555

Email: [tsd-usa@asus.com.tw](mailto:tsd-usa@asus.com.tw)

## ASUS COMPUTER GmbH

### *Marketing Info:*

Address: Harkort Str. 25, 40880 Ratingen, BRD, Germany

Telephone: 49-2102-445011

Fax: 49-2102-442066

Email: [info-ger@asus.com.tw](mailto:info-ger@asus.com.tw)

### *Technical Support:*

BBS: 49-2102-448690

Email: [tsd-ger@asus.com.tw](mailto:tsd-ger@asus.com.tw)

# CONTENTS

---

<b>I. INTRODUCTION.....</b>	<b>1</b>
How this manual is organized .....	1
Item Checklist .....	1
<b>II. FEATURES .....</b>	<b>2</b>
Features of the ASUS Motherboard .....	2
Parts of the ASUS Motherboard .....	3
<b>III. INSTALLATION .....</b>	<b>4</b>
Map of the ASUS Motherboard .....	4
Installation Steps .....	6
1. Jumpers .....	6
Jumper Settings .....	7
Compatible Cyrix CPU Identification .....	11
2. System Memory (DRAM & SRAM) .....	13
DRAM Memory Installation Procedures: .....	13
Static RAM (SRAM) for Level 2 (External) Cache .....	14
Compatible Cache Modules for this Motherboard .....	14
3. Central Processing Unit (CPU) .....	15
4. Expansion Cards .....	16
Expansion Card Installation Procedure: .....	16
Assigning DMA Channels for ISA Cards .....	17
5. External Connectors .....	19
Power Connection Procedures .....	25
<b>IV. BIOS SOFTWARE .....</b>	<b>26</b>
Support Software .....	26
Flash Memory Writer Utility .....	26
Main Menu .....	26
Advanced Features Menu .....	27
Updating your Motherboard's BIOS .....	28
6. BIOS Setup .....	29
Load Defaults .....	30
Standard CMOS Setup .....	30
Details of Standard CMOS Setup: .....	31
BIOS Features Setup .....	34
Details of BIOS Features Setup .....	34
Chipset Features Setup .....	37
Details of Chipset Features Setup .....	37
Power Management Setup .....	40
Details of Power Management Setup .....	40
PNP and PCI Setup .....	42
Details of PNP and PCI Setup .....	42
Load BIOS Defaults .....	44
Load Setup Defaults .....	44
Supervisor Password and User Password .....	45
IDE HDD Auto Detection .....	46
Save and Exit Setup .....	47
Exit Without Saving .....	47
<b>V. DESKTOP MANAGEMENT .....</b>	<b>49</b>
Desktop Management Interface (DMI) .....	49
Introducing the ASUS DMI Configuration Utility .....	49
System Requirements .....	49
Using the ASUS DMI Configuration Utility .....	50
Notes: .....	50

# CONTENTS

---

<b>VI. Microsoft Windows 95 .....</b>	<b>53</b>
Video Driver Installation .....	53
Video Driver Installation .....	54
Video Driver Installation .....	55
Video Driver Installation .....	56
Software MPEG & Video Player .....	57
Windows 95 Display Settings .....	58
<b>VII. Microsoft Windows 3.x .....</b>	<b>59</b>
Video Driver Installation .....	59
Video Driver Installation .....	60
Software MPEG & Video Player .....	61
ATI Desktop Control Panel .....	62
ATI Desktop Features .....	62
FlexDesk+ .....	63
FlexDesk+ Basic Settings .....	63
FlexDesk+ Advanced Settings .....	65
DPMS (for Windows) .....	66
Timer Settings .....	66
Buttons .....	66
DeskScape .....	67
DeskScape Functions .....	67
Buttons .....	68
WinSwitch .....	68
Screen Adjustment .....	69
DPMS Parameters .....	71
<b>VIII. Windows Video Player .....</b>	<b>72</b>
ATI Player and control panel (Win3.1x and Win95) .....	72
Features .....	72
Video Acceleration Performance .....	73
Playing Video Clips .....	73
Sizing Windows .....	73
<b>IX. Microsoft Windows NT .....</b>	<b>74</b>
Video Driver Installation .....	74
Video Driver Installation .....	75
Video Driver Installation .....	76
Video Driver Installation .....	77
<b>X. IBM OS/2 &amp; OS/2 Warp .....</b>	<b>78</b>
Video Driver Installation .....	78
<b>XI. Other Video Drivers .....</b>	<b>79</b>
AutoCAD Video Driver Installation .....	79
Microstation Video Driver Installation .....	80
Select System Information (optional) .....	81
Quick Setup (optional) .....	81
VDIF Files (optional) .....	82
Advanced Setup (optional) .....	83
<b>A. Troubleshooting .....</b>	<b>85</b>
Diagnostics .....	85
Troubleshooting .....	85
System Lockup .....	85

# FCC & DOC COMPLIANCE

---

## ***Federal Communications Commission Statement***

This device complies with FCC Rules Part 15. Operation is subject to the following two conditions:

- This device may not cause harmful interference, and
- This device must accept any interference received, including interference that may cause undesired operation.

This equipment has been tested and found to comply with the limits for a Class B digital device, pursuant to Part 15 of the FCC Rules. These limits are designed to provide reasonable protection against harmful interference in a residential installation. This equipment generates, uses and can radiate radio frequency energy and, if not installed and used in accordance with manufacturer's instructions, may cause harmful interference to radio communications. However, there is no guarantee that interference will not occur in a particular installation. If this equipment does cause harmful interference to radio or television reception, which can be determined by turning the equipment off and on, the user is encouraged to try to correct the interference by one or more of the following measures:

- Re-orient or relocate the receiving antenna.
- Increase the separation between the equipment and receiver.
- Connect the equipment to an outlet on a circuit different from that to which the receiver is connected.
- Consult the dealer or an experienced radio/TV technician for help.

**WARNING:** The use of shielded cables for connection of the monitor to the graphics card is required to assure compliance with FCC regulations. Changes or modifications to this unit not expressly approved by the party responsible for compliance could void the user's authority to operate this equipment.

## ***Canadian Department of Communications Statement***

This digital apparatus does not exceed the Class B limits for radio noise emissions from digital apparatus set out in the Radio Interference Regulations of the Canadian Department of Communications.

# I. INTRODUCTION

## How this manual is organized

This manual is divided into the following sections:

- I. Introduction:** Manual information and checklist
- II. Features:** Information and specifications concerning this product
- III. Installation:** Instructions on setting up the motherboard.
- IV. BIOS Setup:** BIOS software setup information.
- V. DMI Utility:** BIOS supported Desktop Management Interface
- VI. VGA Drivers:** ATI VGA Drivers and Utilities

## Item Checklist

Please check that your package is complete. If you discover damaged or missing items, please contact your retailer.

- The ASUS P/I-AP55TV motherboard
- 1 IDE ribbon cable
- 1 floppy ribbon cable
- Support drivers and utilities as follows (view FILELIST.TXT for details)
  - Flash Memory Writer utility to update the FLASH BIOS
  - Desktop Management Interface (DMI) utility
  - Bus Master IDE Drivers for various operating systems
  - Readme files for descriptions and use of the files
  - Technical Support Form
  - ATI Video drivers and utilities (CD)
  - Creative Labs Audio drivers and utilities (CD)
- This user's manual with VGA driver installation
- Creative Labs ViBRA 16C Audio Manual
- Optional ASUS pipelined burst cache module
- Optional infrared module
- Optional ASUS PCI-SC200 Fast-SCSI card

## II. FEATURES

---

### Features of the ASUS Motherboard

The ASUS P/I-AP55TV is specially designed for the demanding PC user who wants a high-performance multi-media motherboard in a single package. This motherboard:

- **Easy Installation:** Is equipped with BIOS that supports auto detection of hard drives, PS/2 mouse, and Plug and Play devices to make setup of hard drives, expansion cards, and other devices virtually automatic.
- **Multi-Processor/Multi-Speed Support:** Supports one Pentium (75-200MHz), Cyrix P166+ (Rev 2.7 or later), or AMD-K5 (PR75-100MHz) (See page 10).
- **Intel Chipset:** Features Intel's 430VX PCIsset with I/O subsystems.
- **Desktop Management Interface (DMI):** Supports DMI through BIOS which allows hardware to communicate within a standard protocol creating a higher level of compatibility. (Requires DMI-enabled components.) (See section V)
- **L2 Cache:** Comes in 0KB, 256KB, or 512KB Pipelined Burst SRAM version, each version is upgradeable to 256KB or 512KB. Upgrades are made through a **Synchronous SRAM** cache module. (See page 14 for compatible modules.)
- **Versatile DRAM Memory Support:** Supports 72-pin SIMMs of 4MB, 8MB, 16MB, or 32MB to form a memory size between 8MB to 128MB. Supports both Fast Page Mode (FPM) and Extended Data Output (EDO) SIMMs.
- **Riser Expansion Slot:** Supports slot expansion through a daughter card (called a Riser card) with ISA and/or PCI slots (provided by retailer)
- **Super Multi-I/O:** Provides two high-speed UART compatible serial ports and one parallel port with EPP and ECP capabilities. UART2 can also be directed from COM2 to the Infrared Module for wireless connections. Two floppy drives of either 5.25" or 3.5" (1.44MB or 2.88MB) are also supported without an external card. **The Japanese "Floppy 3 mode" (3.5" 1.2MB) floppy standard is also supported.**
- **PCI Bus Master IDE Controller:** Comes with an onboard PCI Bus Master IDE controller with two connectors that supports four IDE devices in two channels, provides faster data transfer rates, and supports Enhanced IDE devices such as Tape Backup and CD-ROM drives. This controller supports PIO Modes 3 and 4 and Bus Master IDE DMA Mode 2. **BIOS now supports IDE CD-ROM or SCSI bootup.**
- **Ready-to-Use Connectors:** Is equipped with onboard Monitor, Parallel (Printer) Port, Serial Ports (COM1&2), PS/2 Mouse, and PS/2 Keyboard connectors without the need for extra cables and brackets.
- **Multi-Media Ready:** Includes Creative Labs 16C Audio and ATI Mach64 Video onboard.
- **Upgradeable Video Memory:** Includes 1MB DRAM onboard and upgradeable to 4MB DRAM.



# II. FEATURES

- **Optional IrDA Connector:** Supports an optional infrared port module for wireless interface.
- **NCR SCSI BIOS:** Has firmware that supports the optional ASUS PCI-SC200 SCSI controller cards.

## Parts of the ASUS Motherboard

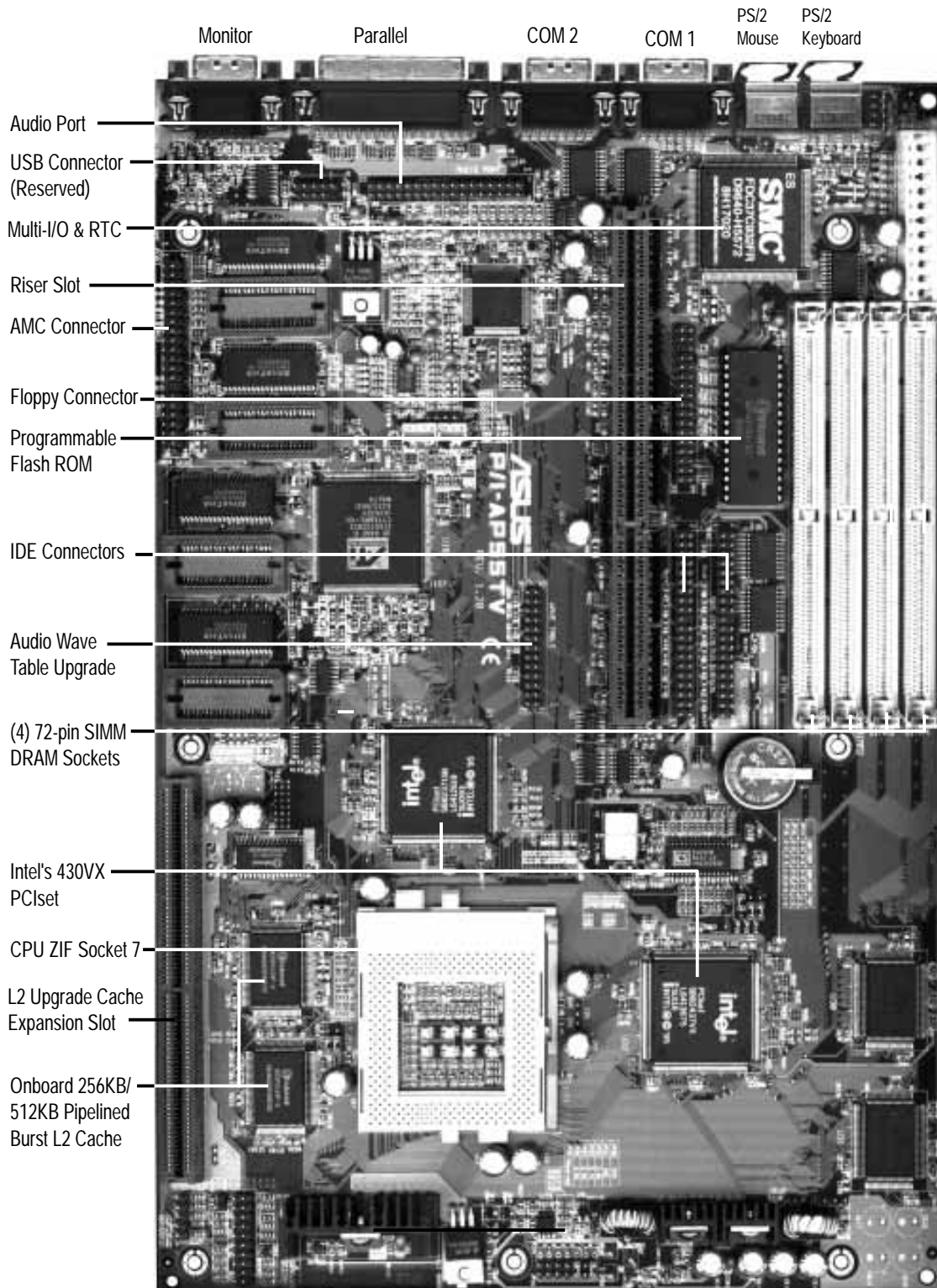

II. FEATURES  
(Parts of Board)

# III. INSTALLATION

## Map of the ASUS Motherboard

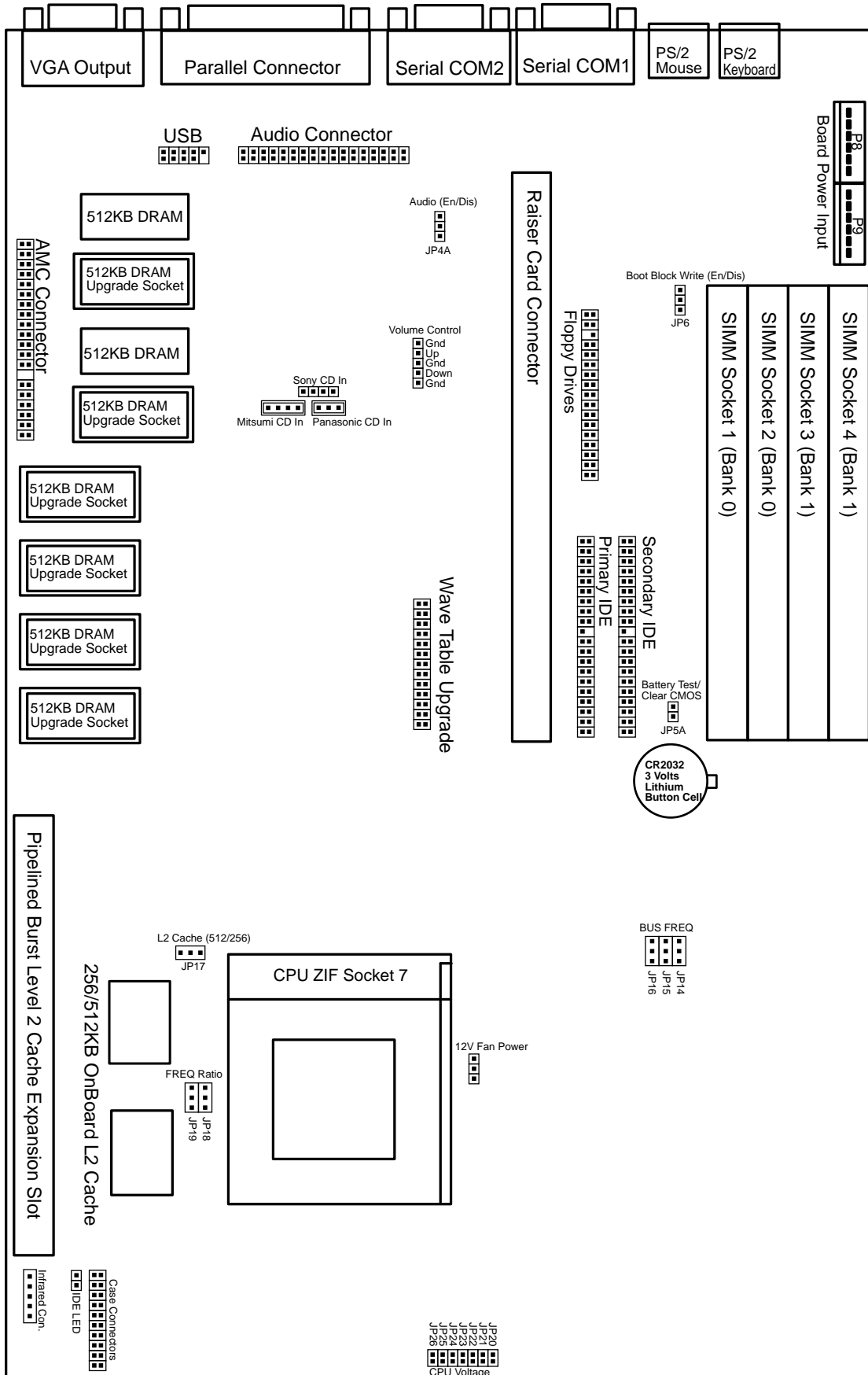

**III. INSTALLATION**  
(Map of Board)

# III. INSTALLATION

---

## Jumpers

- |                 |       |   |
|-----------------|-------|---|
| 1) JP6          | p. 7  | Flash ROM Boot Block Program (Enable/Disable) |
| 2) JP5A         | p. 7  | Clear CMOS Data / Battery Test Jumper         |
| 3) JP17         | P. 8  | Total L2 Cache Size (512KB / 256KB)           |
| 4) JP4A         | p. 9  | Audio Selection (Enabled/Disabled)            |
| 5) VOL_CON      | p. 9  | Digital Volume Control (Up / Down)            |
| 6) JP14, 15, 16 | p. 10 | CPU External Clock (BUS) Frequency Selection  |
| 7) JP18, 19     | p. 10 | CPU:BUS Frequency Ratio                       |
| 8) JP20-26      | p. 11 | Voltage Regulator Output Selection            |

## Expansion Slots

- |                       |       |   |
|-----------------------|-------|---|
| 1) SIMM Sockets       | p. 11 | DRAM Memory Expansion Sockets               |
| 2) L2 Cache Expansion | p. 14 | Pipelined Burst SRAM L2 Cache Module Socket |
| 3) CPU ZIF Socket 7   | p. 15 | Central Processing Unit (CPU) Socket        |
| 4) Riser Slot         | p. 18 | Slot for a Riser Expansion Slot Card        |

## Connectors

- |                       |       |   |
|-----------------------|-------|---|
| 1) PS2KB              | p. 19 | PS/2 Keyboard Connector (6-pin Female)            |
| 2) PS2MOUSE           | p. 19 | PS/2 Mouse Connector (6-pin Female)               |
| 3) COM1, COM2         | p. 19 | Serial Port COM1 & COM2 (9-pin Male)              |
| 4) PRINTER            | p. 20 | Parallel (Printer) Port Connector (25-pin Female) |
| 5) VGA Monitor Output | p. 20 | Video Connector for VGA Monitor (15-pin Female)   |
| 6) FLOPPY             | p. 20 | Floppy Drive Connector (34-pin Block)             |
| 7) IDE1, IDE2         | p. 21 | Primary / Secondary IDE Connector (40-pin Blocks) |
| 8) IDELED             | p. 21 | IDE LED Activity Light                            |
| 9) TB LED (CON1)      | p. 22 | Turbo LED/Power LED (2-pins)                      |
| 10) SMI (CON1)        | p. 22 | SMI Switch Lead (2-pins)                          |
| 11) RESET (CON1)      | p. 22 | Reset Switch Lead (2-pins)                        |
| 12) KEYLOCK (CON1)    | p. 22 | Keyboard Lock Switch Lead (5-pins)                |
| 13) SPEAKER (CON1)    | p. 22 | Speaker Connector (4-pins)                        |
| 14) IR                | p. 23 | Infrared Port Module Connector                    |
| 15) Power Input       | p. 23 | Motherboard Power Connector (12-pin Block)        |







# III. INSTALLATION

## Installation Steps

Before using your computer, you must follow the six steps as follows:

1. Set Jumpers on the Motherboard
2. Install DRAM Modules
3. Install the CPU
4. Install Expansion Cards
5. Connect Cables, Wires, and Power Supply
6. Setup the BIOS Software

### 1. Jumpers

Several hardware settings are made through the use of jumper caps to connect jumper pins (JP) on the motherboard. See "Map of the Motherboard" on page 4 for locations of jumpers. The jumper settings will be described numerically such as [----], [1-2], [2-3] for no connection, connect pins 1&2, and connect pins 2&3 respectively. Pin 1 for our motherboards is always on top  or on the left  when holding the motherboard with the keyboard connector away from yourself. A "1" is written besides pin 1 on jumpers with three pins. The jumpers will also be shown graphically such as  to connect pins 1&2 and  to connect pins 2&3. Jumpers with two pins will be shown as  for short (On) and  for open (Off). For manufacturing simplicity, the jumpers may be sharing pins from other groups. Use the diagrams in this manual instead of following the pin layout on the board. Settings with two jumper numbers require that both jumpers be moved together. To connect the pins, simply place a plastic jumper cap over the two pins as diagramed.

**WARNING:** Computer motherboards and components contain very delicate Integrated Circuit (IC) chips. To protect the motherboard and other components against damage from static electricity, you should follow some precautions whenever you work on your computer.

1. Unplug your computer when working on the inside.
2. Hold components by the edges and try not to touch the IC chips, leads, or circuitry.
3. Use a grounded wrist strap before handling computer components.
4. Place components on a grounded antistatic pad or on the bag that came with the component whenever the components are separated from the system.

# III. INSTALLATION

## Jumper Settings

### 1. Flash ROM Boot Block Programming (JP6)

This sets the operation mode of the boot block area of the BIOS Flash ROM to allow programming in the *Enabled* position.

#### Programming JP6

Disabled [1-2] (Default)

Enabled [2-3]

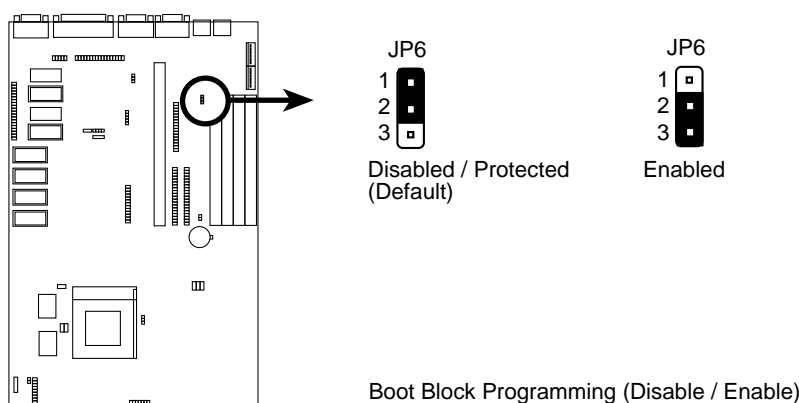

### 2. Clear CMOS Data / Battery Test Jumper (JP5A)

The CMOS RAM is powered by the onboard button cell battery. You can test the battery's current by removing this jumper and attaching a current meter to each pin. **WARNING: You must unplug the power cord to your power supply to ensure that there is no power to your motherboard. The CMOS RAM containing BIOS setup information will be cleared by this action. You must enter BIOS to "Load Setup Defaults" and re-enter any user information after removing and reapplying this jumper.**

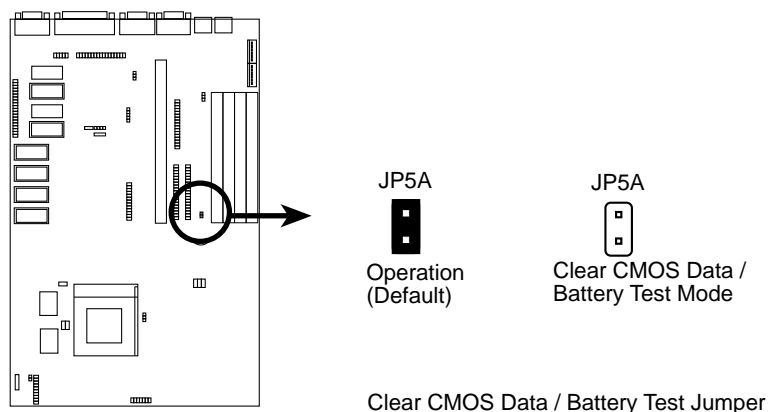

# III. INSTALLATION

## 3. Total Level 2 Cache Size Setting (JP17)

This jumper sets the total amount of L2 cache that is present. If you have two cache chips onboard (see "Map of Motherboard" for locations), then you have 256KB. A cache module can be used to upgrade the 256KB version to 512KB. If there is no onboard cache, you may install a cache module of either 256KB or 512KB. **IMPORTANT: See page 14 "SRAM Cache" for installation procedures.** Regardless of your cache combination, set the following jumpers according to the **total** amount of L2 cache that is present onboard and installed as a module.

<u>L2 Cache Size</u>	<u>JP17</u>
256KB	[2-3] (default)
512KB	[1-2]

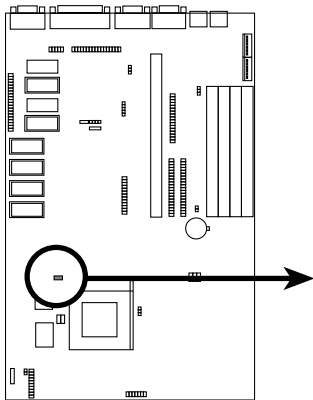

Total L2 Cache Size Setting (256KB / 512KB)

# III. INSTALLATION

## 4. Onboard Audio Selection (JP4A)

This jumper allows you to Disable the onboard audio chipset in order to use your own audio card. Otherwise, leave on default of Enabled.

<u>Onboard Audio</u>	<u>JP4A</u>
Enabled	[1-2] (Default)
Disabled	[2-3]

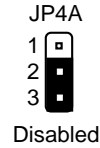
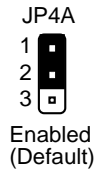
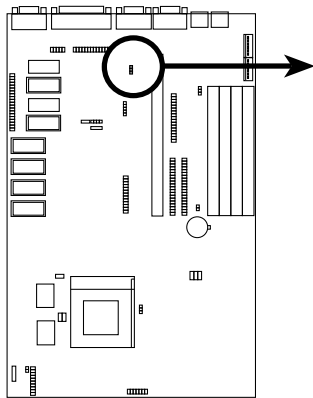

Onboard Audio Selection (Enable / Disabled)

## 5. Onboard Digital Audio Control (VOL\_CON)

This jumper allows you to adjust the audio volume digitally using case mounted momentary buttons.

<u>Audio Control</u>	<u>VOL_CON</u>
Volume Up	[1-2] (momentary)
Volume Down	[4-5] (momentary)

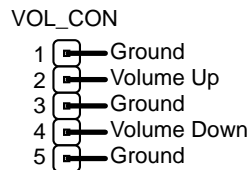
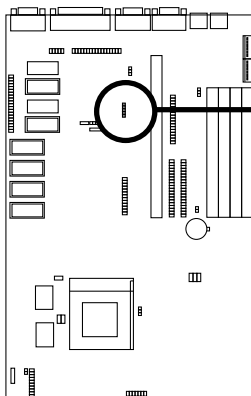

Onboard Digital Audio Control

# III. INSTALLATION

## 6. CPU External (BUS) Frequency Selection (JP14, JP15, JP16)

These jumpers tell the clock generator what frequency to send to the CPU. These allow the selection of the CPU's *External* frequency (or *BUS Clock*). The BUS Clock times the BUS Ratio equals the CPU's *Internal* frequency (the advertised CPU speed).

## 7. CPU to BUS Frequency Ratio (JP18, JP19)

These jumpers set the frequency ratio between the *Internal* frequency of the CPU and the *External* frequency (called the *BUS Clock*) within the CPU. These must be set together with the above jumpers *CPU External (BUS) Frequency Selection*.

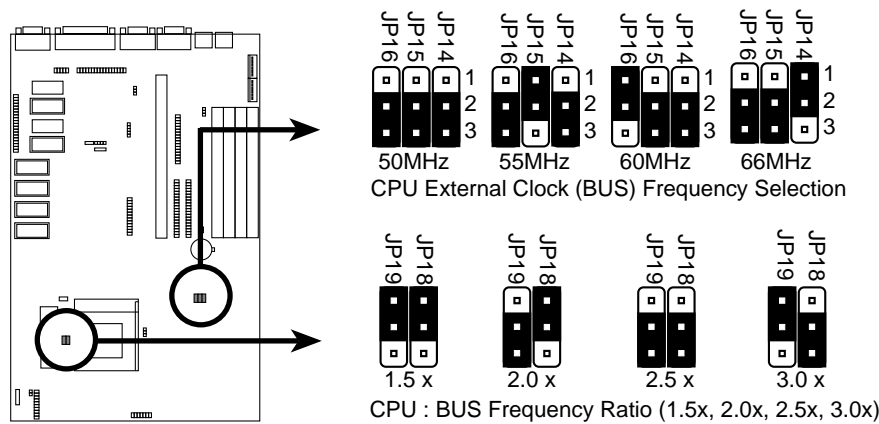

III. INSTALLATION  
(Jumpers)

Set the jumpers by the Internal speed of the Intel, AMD, or Cyrix CPU as follows:

CPU Model	Freq.	Ratio	BUS Freq.	(BUS Freq.)			(Freq. Ratio)	
				JP16	JP15	JP14	JP19	JP18
Intel Pentium	200MHz	3.0x	66MHz	[2-3]	[2-3]	[1-2]	[1-2]	[2-3]
Intel Pentium	166MHz	2.5x	66MHz	[2-3]	[2-3]	[1-2]	[2-3]	[2-3]
Intel Pentium	150MHz	2.5x	60MHz	[1-2]	[2-3]	[2-3]	[2-3]	[2-3]
Intel Pentium	133MHz	2.0x	66MHz	[2-3]	[2-3]	[1-2]	[2-3]	[1-2]
Intel Pentium	120MHz	2.0x	60MHz	[1-2]	[2-3]	[2-3]	[2-3]	[1-2]
Intel Pentium	100MHz	1.5x	66MHz	[2-3]	[2-3]	[1-2]	[1-2]	[1-2]
Intel Pentium	90MHz	1.5x	60MHz	[1-2]	[2-3]	[2-3]	[1-2]	[1-2]
Intel Pentium	75MHz	1.5x	50MHz	[2-3]	[2-3]	[2-3]	[1-2]	[1-2]
AMD	100MHz	1.5x	66MHz	[2-3]	[2-3]	[1-2]	[1-2]	[1-2]
AMD	90MHz	1.5x	60MHz	[1-2]	[2-3]	[2-3]	[1-2]	[1-2]
AMD	75MHz	1.5x	50MHz	[2-3]	[2-3]	[2-3]	[1-2]	[1-2]
*Cyrix 166+	133MHz	2.0x	66MHz	[2-3]	[2-3]	[1-2]	[2-3]	[1-2]

**\*NOTE:** Only Cyrix Revision 2.7 or later is supported on this motherboard. See next page for revision identification. Bootup screen will show **6x86-P166+ -S CPU at 133MHz** with the Cyrix 166+ installed on this motherboard.



# III. INSTALLATION

## Compatible Cyrix CPU Identification

The Cyrix CPU that is supported on this motherboard is labeled Cyrix 6x86 P166+ but must be Revision 2.7 and later. Look on the underside of the CPU for the serial number. The number should read G8DC6620A or larger.

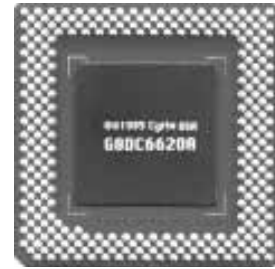

### 8. Voltage Regulator Output Selection (JP20-JP26)

These jumpers set the voltage supplied to the CPU. Determine whether your CPU has a single power plane or dual power planes and then the voltage that it uses. Current Intel CPU's marked "Pentium" has only a single power plane and uses the standard 3.38 volts (STD) or 3.5 volts (VRE). When a single power plane CPU is installed, the dual power plane selections will be automatically disabled. When a dual power plane CPU is installed, the single power plane selections will be automatically disabled. You may have one jumper on the **Single Power Plane** and another on the **Dual Power Planes** at the same time.



Intel P54C Pentium  
(75-200MHz)



Intel P55C Pentium  
MMX (200MHz)



AMD-K5  
PR100  
(PR75-133MHz)



Cyrix 6x86 166+  
Rev2.7 (133MHz)

III. INSTALLATION  
(System Memory)

<u>Single Power Plane</u>	<u>Type</u>	<u>Voltage</u>	<u>Dual Power Planes</u>	<u>Voltage</u>
JP20 [short] (Default)	STD	3.38V	JP22 [short] (Default)	2.8V
JP21 [short]	VRE	3.5V	JP23 [short]	2.7V
			JP24 [short]	2.9V
			JP25 [short]	2.5V
			JP26 [short]	Res.

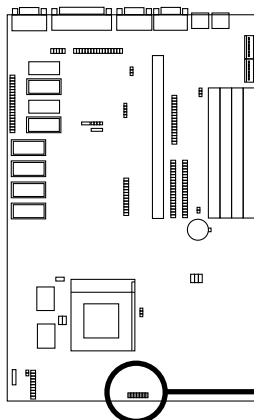

JP20 [short] STD  
 JP21 [short] VRE  
 JP22 [short] 2.8V  
 JP23 [short] 2.7V  
 JP24 [short] 2.9V  
 JP25 [short] 2.5V  
 JP26 [short] Res.  
 (Default)

Voltage Regulator Output Selection

# III. INSTALLATION

## 2. System Memory (DRAM & SRAM)

This motherboard supports four 72-pin SIMMs (Single Inline Memory Modules) of 4MB, 8MB, 16MB, or 32MB to form a memory size between 8MB to 128MB. The DRAM can be either 60ns or 70ns Fast Page Mode (FPM) (Asymmetric or Symmetric) or Enhanced Data Output (EDO). SIMMs must be installed in pairs so that each bank contains two of the same size memory modules. Maximum memory size of SIMM's must be 128MB or less.

**IMPORTANT: Memory speed setup is required in BIOS Chipset Setup "Auto Configuration."**

*Install memory in any or all of the banks in any combination as follows:*

Bank	Memory Module		Total Memory
Bank 0 SIMM Slots 1&2	4MB, 8MB, 16MB, 32MB 72-pin FPM or EDO SIMM	x2	
Bank 1 SIMM Slots 3&4	4MB, 8MB, 16MB, 32MB 72-pin FPM or EDO SIMM	x2	
Total System Memory (Max 128MB)		=	

**IMPORTANT: Do not use memory modules with more than 24 chips per module. Modules with more than 24 chips exceed the design specifications of the memory subsystem and will be unstable.**

# III. INSTALLATION

## DRAM Memory Installation Procedures:

1. The SIMM memory modules will only fit in one orientation as shown because of a "Plastic Safety Tab" on one end of the SIMM slots which requires the "Notched End" of the SIMM memory modules.

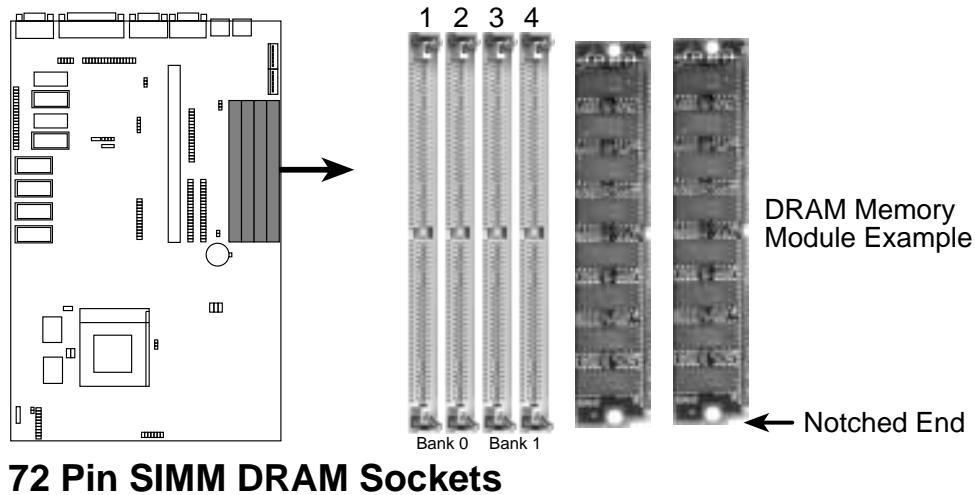

2. Press the memory module firmly into place starting from a 45 degree angle making sure that all the contacts are aligned with the socket.
3. With your finger tips, rock the memory module into a vertical position so that it clicks into place.

### 72 Pin DRAM in SIMM Socket

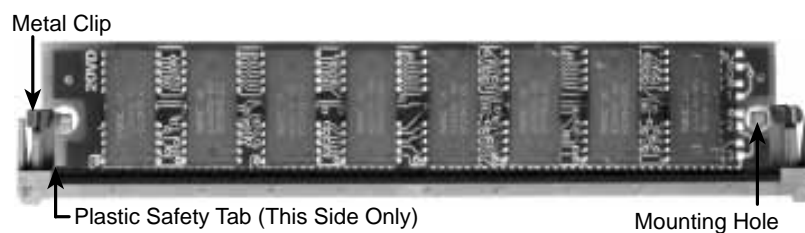

4. The plastic guides should go through the two "Mounting Holes" on the sides and the "Metal Clips" should snap on the other side.
5. To release the memory module, squeeze both "Metal Clips" outwards and rock the module out of the "Metal Clips".

# III. INSTALLATION

## Static RAM (SRAM) for Level 2 (External) Cache

The motherboard you purchase may have either 0KB, 256KB, or 512KB onboard. If you have both onboard cache chips (see "Map of Motherboard" for locations) and a Cache Expansion Slot, then you have 256KB. If you only have onboard cache chips, then you have 512KB. An "ASUS" or "COAST" cache module can be used to upgrade the 256KB version to 512KB. If there is no onboard cache, you may install a cache module of either 256KB or 512KB.

**IMPORTANT:** You must set "Total Level 2 Cache Size Setting" jumper on when changes are made to your cache size.

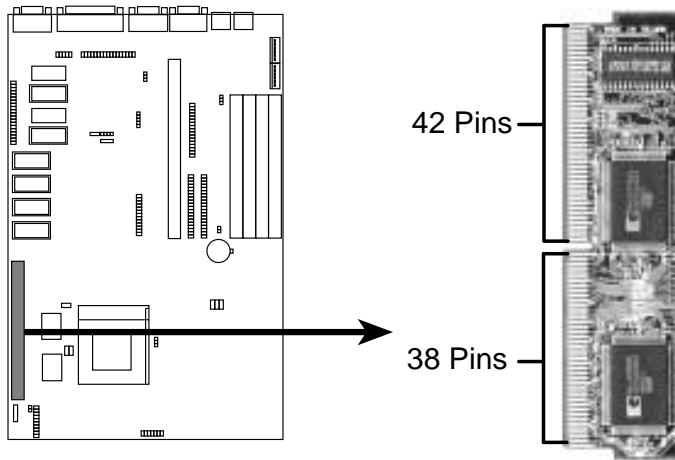

**Pipelined Burst Cache Module**

Insert the module as shown. Because the number of pins are different on either side of the break, the module will only fit in the orientation as shown.

### Compatible Cache Modules for this Motherboard

SIMM Cache Module	256KB to 512KB	0KB to 256/512KB
ASUS CM1 Rev 1.0	----	----
ASUS CM1 Rev 1.3	----	----
ASUS CM4 Rev 1.5	----	----
ASUS CM1 Rev 1.6	<b>Yes</b>	----
ASUS CM1 Rev 3.0 *	<b>Yes</b>	<b>Yes</b>
COAST 1.1	----	----
COAST 1.2	----	----
COAST 1.3	----	----
COAST 2.0	<b>Yes</b>	<b>Yes</b>
COAST 2.1	<b>Yes</b>	<b>Yes</b>
COAST 3.0	<b>Yes</b>	<b>Yes</b>
COAST 3.1	<b>Yes</b>	<b>Yes</b>

\* **NOTE:** ASUS CM1 Rev 3.0 has two TAG SRAM's to comply with COAST 3.0 specifications. This extra TAG SRAM will not conflict with the onboard TAG SRAM.

# III. INSTALLATION

## 3. Central Processing Unit (CPU)

The motherboard provides a 321-pin ZIF Socket 7 that is backwards compatible with ZIF Socket 5 processors. The CPU that came with the motherboard should have a fan attached to it to prevent overheating. If this is not the case then purchase a fan before you turn on your system. Apply thermal jelly to the CPU top and then install the fan onto the CPU.

**WARNING:** Without a fan circulating air on the CPU and heat sinks, the CPU and/or heat sinks can overheat and cause damage to both the CPU and the motherboard. (See "CPU Cooling Fan Connector" at the end of this section.)

To install a CPU, first turn off your system and remove its cover. Locate the ZIF socket and open it by first pulling the lever sideways away from the socket then upwards to a 90-degree right angle. Insert the CPU with the correct orientation as shown. Use the notched corner of the CPU with the white dot as your guide. The white dot should point towards the end the of the lever. Notice that there is a blank area where one hole is missing from that corner of the square array of pin holes and a "1" printed on the motherboard next to that corner. Because the CPU has a corner pin for three of the four corners, the CPU will only fit in the one orientation as shown. The picture is for reference only; you should have a CPU fan that will cover the face of the CPU. With the added weight of the CPU fan, no force is required to insert the CPU. Once completely inserted, hold down on the fan and close the socket's lever.

**IMPORTANT:** You must set jumpers for "CPU to BUS Frequency Ratio" and jumpers for "BUS Frequency Selection" depending on the CPU that you install.

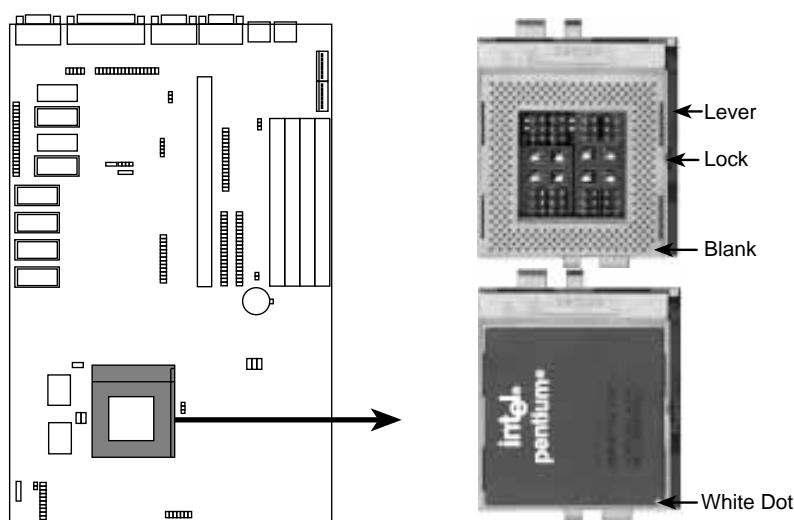

**ZIF Socket 7 with Pentium Processor**

# III. INSTALLATION

## 4. Expansion Cards

**WARNING:** Make sure that you unplug your power supply when adding or removing expansion cards or other system components. Failure to do so may cause severe damage to both your motherboard and expansion cards.

**IMPORTANT:** This motherboard requires a Riser card in order to add expansion cards. Insert the Riser card provided by your retailer into the Riser slot with the notch over the safety tab. The Riser card cannot be inserted in the wrong orientation because of the safety tab. The following is an example only. Your riser card may look different. Check your system manual for specific settings that may be needed.

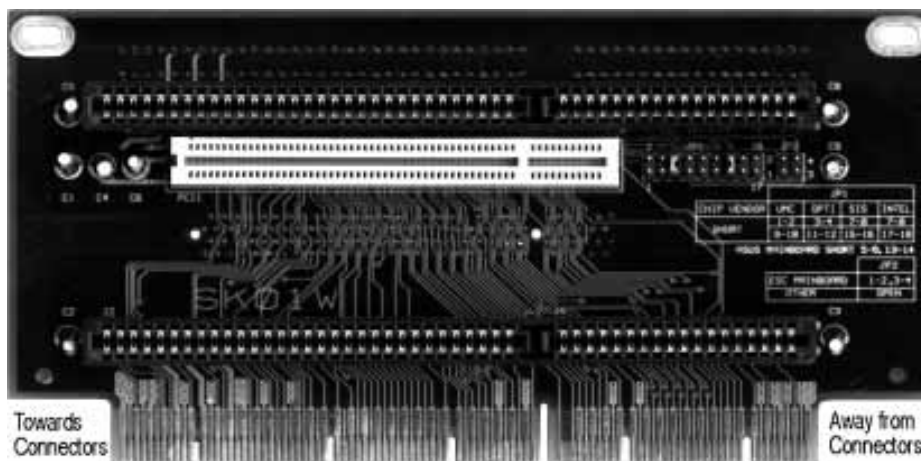

### *Expansion Card Installation Procedure:*

1. Read the documentation for your expansion card.
2. Set any necessary jumpers on your expansion card.
3. Remove your computer system's cover.
4. Remove the bracket on the slot you intend to use. Keep the bracket for possible future use.
5. Carefully align the card's connectors and press firmly.
6. Secure the card on the slot with the screw you removed in step 4.
7. Replace the computer system's cover.
8. Setup the BIOS if necessary (such as "IRQ xx Used By ISA: Yes" in PNP AND PCI SETUP)
9. Install the necessary software drivers for your expansion card.

# III. INSTALLATION

---

Both ISA and PCI expansion cards may need to use IRQs. System IRQs are available to cards installed in the ISA expansion bus first, and any remaining IRQs are then used by PCI cards. Currently, there are two types of ISA cards. The original ISA expansion card design, now referred to as "Legacy" ISA cards, requires that you configure the card's jumpers manually and then install it in any available slot on the ISA bus. You may use Microsoft's Diagnostic (MSD.EXE) utility included in the Windows directory to see a map of your used and free IRQs. For Windows 95 users, the "Control Panel" icon in "My Computer," contains a "System" icon which gives you a "Device Manager" tab. Double clicking on a specific device give you "Resources" tab which shows the Interrupt number and address. Make sure that no two devices use the same IRQs or your computer will experience problems when those two devices are in use at the same time.

To simplify this process this motherboard has complied with the Plug and Play (PNP) specification which was developed to allow automatic system configuration whenever a PNP-compliant card is added to the system. For PNP cards, IRQs are assigned automatically from those available.

If the system has both Legacy and PNP ISA cards installed, IRQs are assigned to PNP cards from those not used by Legacy cards. The PCI and PNP configuration of the BIOS setup utility can be used to indicate which IRQs are being used by Legacy cards. For older Legacy cards that does not work with the BIOS, you can contact your vendor for an ISA Configuration Utility.

An IRQ number is automatically assigned to PCI expansion cards after those used by Legacy and PNP ISA cards. In the PCI bus design, the BIOS automatically assigns an IRQ to a PCI slot that has a card in it that requires an IRQ. To install a PCI card, you need to set something called the INT (interrupt) assignment. Since all the PCI slots on this motherboard use an INTA #, be sure that the jumpers on your PCI cards are set to INT A.

## *Assigning DMA Channels for ISA Cards*

Some ISA cards, both Legacy and PNP may also need to use a DMA (Direct Memory Access) channel. DMA assignments for this motherboard are handled the same way as the IRQ assignment process described above. You can select a DMA channel in the PCI and PNP configuration section of the BIOS Setup utility.

**IMPORTANT: Choose "Yes" for those IRQ's and DMA's you wish to reserve for Legacy (Non-PnP) ISA expansion cards in "IRQ xx Used By ISA" and "DMA x Used By ISA" of the PNP and PCI Setup in the BIOS SOFTWARE section, otherwise conflicts may occur.**

---

(This page was intentionally left blank)



# III. INSTALLATION

## 5. External Connectors

**WARNING:** Some pins are used for connectors or power sources. These are clearly separated from jumpers in "Map of the Motherboard" on page 4. Placing jumper caps over these will cause damage to your motherboard.

**IMPORTANT:** Ribbon cables should always be connected with the red stripe on the Pin 1 side of the connector. The four corners of the connectors are labeled on the motherboard. Pin 1 is the side closest to the power connector on hard drives and floppy drives. IDE ribbon cable must be less than 18in. (46cm), with the second drive connector no more than 6in. (15cm) from the first connector.

### 1. PS/2 Keyboard Connector (6-pin Female)

This connection is for a standard keyboard using an PS/2 plug (mini DIN). This connector will not allow standard AT size (large DIN) keyboard plugs. You may use a DIN to mini DIN adapter on standard AT keyboards.



PS/2 Keyboard (6-pin Female)

### 2. PS/2 Mouse Connector (6-pin Female)

The system will direct IRQ12 to the PS/2 mouse if one is detected. If not detected, expansion cards can use IRQ12. See "PS/2 Mouse Control" in BIOS Features Setup of the BIOS SOFTWARE.



PS/2 Mouse (6-pin Female)

### 3. Serial Port COM1 and COM2 Connectors (Two 9-pin Male)

The two serial ports can be used for pointing devices or other serial devices. See "Onboard Serial Port" in Chipset Features Setup of the BIOS SOFTWARE.



COM 1      COM 2  
Serial Ports (9-pin Male)

# III. INSTALLATION

## 4. Parallel Printer Connector (25-pin Female)

You can enable the parallel port and choose the IRQ through "Onboard Parallel Port" in Chipset Features Setup of the BIOS SOFTWARE. **NOTE:** Serial printers must be connected to the serial port.



Parallel (Printer) Port (25-pin Female)

## 5. VGA Monitor Output (15-pin Female)

There is a built-in video chip on this motherboard so that a separate video card is not necessary. Connect your monitor cable to the onboard monitor output connector.



VGA Monitor Output (15-pin Female)

## 6. Floppy Drive Connector (34-pin block )

This connector supports the provided floppy drive ribbon cable. After connecting the single end to the board, connect the two plugs on the other end to the floppy drives. **(Pin 5 is removed to prevent inserting in the wrong orientation when using ribbon cables with pin 5 plugged).**

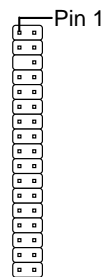
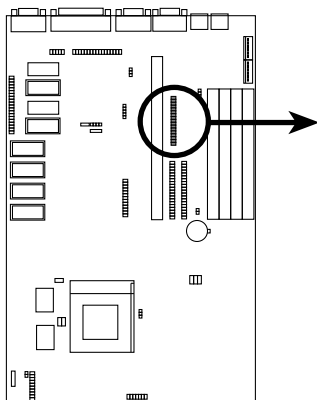

Connect the Red stripe to Pin 1

Floppy Drive Connector

# III. INSTALLATION

## 7. Primary / Secondary IDE Connectors (Two 40-pin Block)

These connectors support the provided IDE hard disk ribbon cable. After connecting the single end to the board, connect the two plugs at the other end to your hard disk(s). If you install two hard disks, you must configure the second drive to Slave mode by setting its jumper accordingly. Please refer to the documentation of your hard disk for the jumper settings. BIOS now supports SCSI device or IDE CD-ROM bootup (see "HDD Sequence SCSI/IDE First" & "Boot Sequence" in the BIOS Features Setup of the BIOS SOFTWARE) (**Pin 20 is removed to prevent inserting in the wrong orientation when using ribbon cables with pin 20 plugged**).

**TIP:** You may configure two hard disks to be both Masters using one ribbon cable on the primary IDE connector and another ribbon cable on the secondary IDE connector. You may install one operating system on an IDE drive and another on a SCSI drive and select the boot disk through BIOS Features Setup.

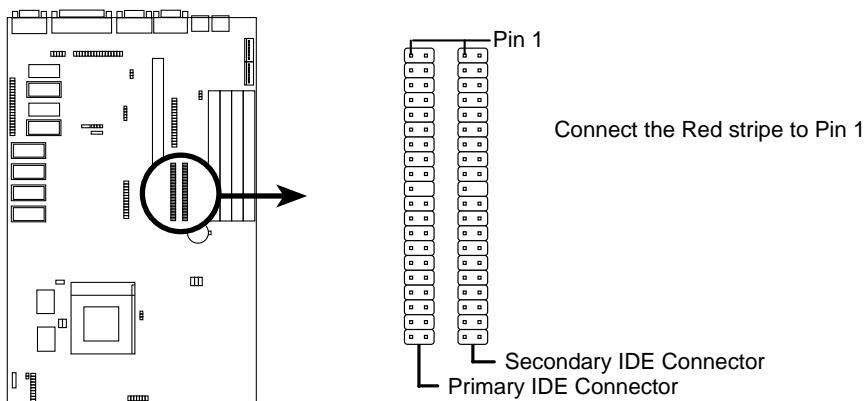

## 8. IDE Activity LED (IDE LED)

This connector supplies power to the cabinet's IDE activity LED. Read and write activity by devices connected to the Primary or Secondary IDE connectors will cause the LED to light up.

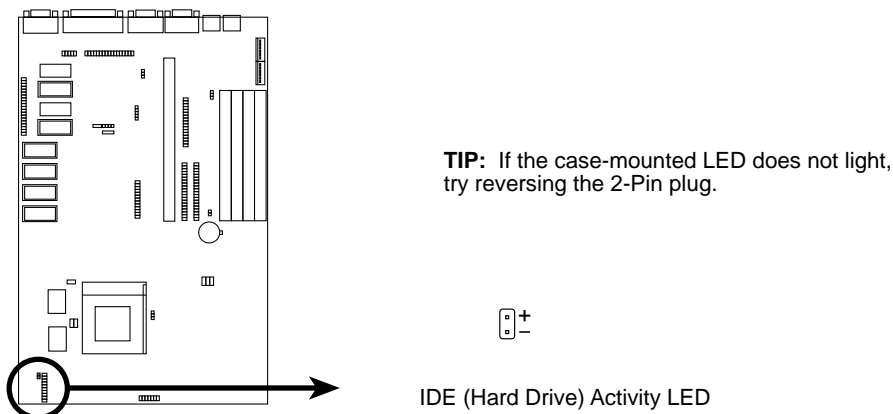

# III. INSTALLATION

## 9. System Power LED (TB LED)

The motherboard's turbo function is always on. The turbo LED connection is labeled here but the LED will remain constantly lit while the system power is on. You may wish to connect the Power LED from the system case to this lead. See the figure below.

## 10. SMI Suspend Switch Lead (SMI)

This allows the user to manually place the system into a suspend mode or "Green" mode where system activity will be instantly decreased to save electricity and expand the life of certain components when the system is not in use. This 2-pin connector (see the figure below) connects to the case-mounted suspend switch. If you do not have a switch for the connector, you may use the "Turbo Switch" since it does not have a function. SMI is activated when it detects a *short to open* moment and therefore leaving it shorted will not cause any problems. May require one or two pushes depending on the position of the switch. Wake-up can be controlled by settings in the BIOS but the keyboard will always allow wake-up (the SMI lead cannot wake-up the system). If you want to use this connector, "Suspend Switch" in the POWER MANAGEMENT SETUP of the BIOS software should be on the default setting of *Enable*. See the figure below.

## 11. Reset Switch Lead (RESET)

This 2-pin connector connects to the case-mounted reset switch for rebooting your computer without having to turn off your power switch. This is a preferred method of rebooting in order to prolong the life of the system's power supply. See the figure below.

## 12. Keyboard Lock Switch Lead & System Power LED (KEYLOCK)

This 5-pin connector connects to the case-mounted keyboard lock switch for locking the keyboard and also to connect the system power LED. The system power LED lights when the system is powered on. See the figure below.

## 13. Speaker Connector (SPEAKER)

This 4-pin connector connects to the case-mounted speaker.

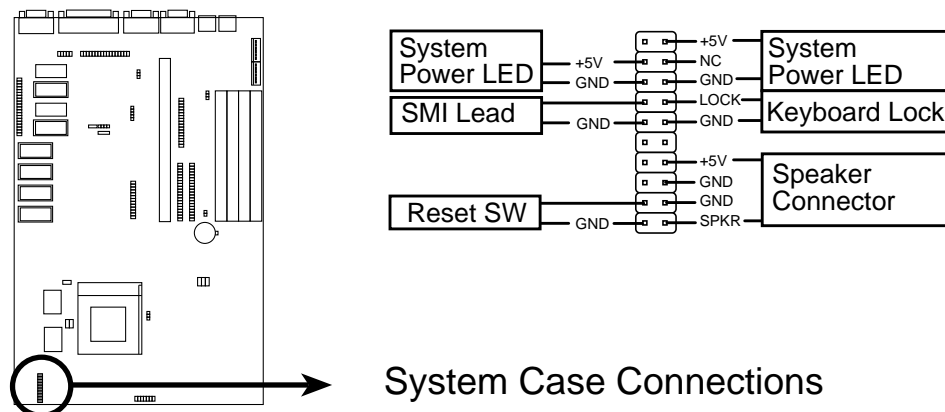

# III. INSTALLATION

## 14. IrDA-Compliant Infrared Module Connector (IR)

This connector supports the optional wireless transmitting and receiving infrared module. This module mounts to a small opening on system cases that support this feature. You must also configure the setting through "UART2 Use Infrared" in **Chipset Features Setup** to select whether UART2 is directed for use with COM2 or IrDA. Use the five pins as shown on the Back View and connect a ribbon cable from the module to the motherboard according to the pin definitions.

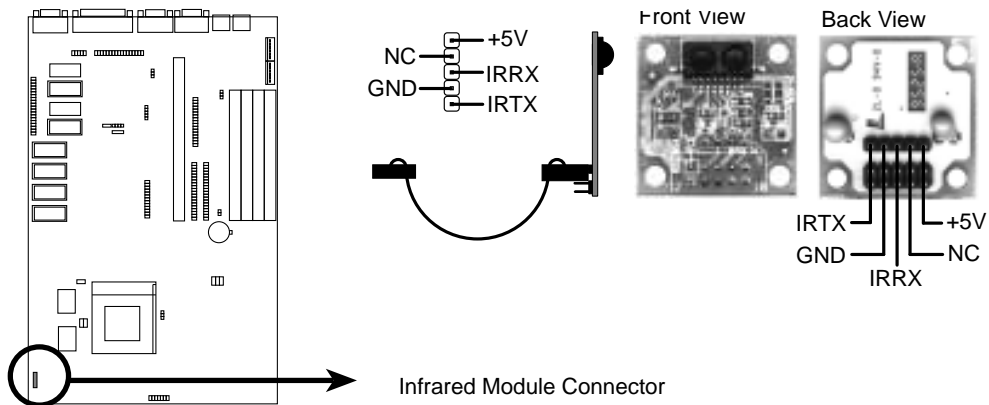

## 15. Power Input Connector (12-pin block)

This connector connects to a standard 5 Volt power supply. To connect the leads from the power supply, ensure first that the power supply is not plugged. Most power supplies provide two plugs (P8 and P9), each containing six wires, two of which are black. Orient the connectors so that the black wires are located in the middle.

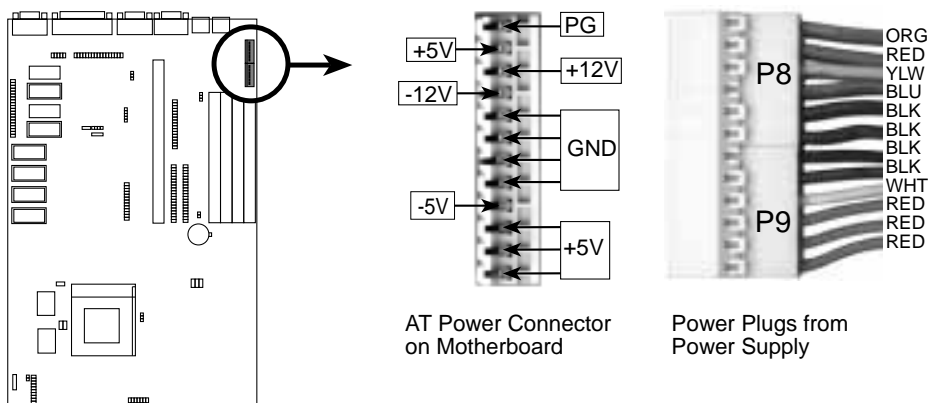

Using a slight angle, align the plastic guide pins on the lead to their receptacles on the connector. Once aligned, press the lead onto the connector until the lead locks into place.

---

(This page was intentionally left blank)

# III. INSTALLATION

---

## Power Connection Procedures

1. After all jumpers and connections are made, close the system case cover.
2. Make sure that all switches are in the off position as marked by ○.
3. Connect the power supply cord into the power supply located on the back of your system case as instructed by your system user's manual.
4. Connect all power cords into a power strip that is equipped by a surge protector.
5. You may then turn on your devices in the following order:
  - a. Your monitor
  - b. External SCSI devices (starting with the last device on the chain)
  - c. Your system power
6. The power LED on the front panel of the system case will light and the monitor LED as well. The system will then run power-on tests. While the tests are running, additional messages will appear on the screen. If you do not see anything within 30 seconds from the time you turn on the power, the system may have failed a power-on test. Recheck your jumper settings and connections or call your authorized dealer for assistance.
7. During power-on, hold down the <Delete> key to enter BIOS setup. Follow the next section "BIOS SOFTWARE" for instructions.

# IV. BIOS SOFTWARE

## Support Software

**FILELIST.TXT** - View this file to see the files included in the support software.

**PFLASH.EXE** - This is the Flash Memory Writer utility that updates the BIOS by uploading a new BIOS file to the programmable flash ROM chip on the motherboard. To determine the BIOS version, check the last four numbers of the code displayed on the upper left-hand corner of your screen during bootup. Larger numbers represent a newer BIOS file.

**NOTE:** A binary BIOS file is no longer included with the support software. Save the motherboard's BIOS file to a floppy diskette as soon as your system is operational. See "Flash Memory Writer Utility" in this section to "Save Current BIOS to File."

## Flash Memory Writer Utility

```
ASUSTeK PNP BIOS
FLASH MEMORY WRITER V1.5
Copyright (C) 1995, ASUSTeK COMPUTER Inc.

Flash Type -- SST 29EE010
Current BIOS Revision: #401A0-xxxx
Choose one of the following:
1. Save Current BIOS To File
2. Update BIOS Main Block From File
3. Advanced Features

Enter Choice: [ 1]

Press ESC To Exit
```

xxxx denotes the current BIOS version stored in the Flash EPROM

**IMPORTANT:** Flash Type may also be "INTEL 28F001BXT." If "unknown" is shown after "Flash type --," then this ROM chip is not programmable or not supported with the PnP BIOS and therefore cannot be programmed by the Flash Memory Writer.

### Main Menu

#### 1. Save Current BIOS to File (Perform as soon as system is operational)

This option allows you to copy the contents of the Flash memory chip onto a diskette. This gives you a backup copy of the original motherboard BIOS in case you need to re-install it.

**Create a bootable system floppy diskette by typing [FORMAT A:/S] from the DOS environment without creating "AUTOEXEC.BAT" and "CONFIG.SYS" files, then save the PFLASH.EXE and the BIOS to the floppy diskette.**



# IV. BIOS SOFTWARE

---

## 2. Update BIOS Main Block from File

This option updates the BIOS from a file on the disk. This can either be a new file or a backup file created by the "Save Current BIOS to File" option. This will not update the Boot Block if the Boot Block is different. You will be prompted with the following if advanced features if necessary.

```
Boot Block of New BIOS is different from old one !!!
Please Use 'Advanced Feature' to flash whole bios !!!
```

## 3. Advanced Features

Selecting this option brings up the Advanced Features screen for clearing the PnP configuration record and updating the motherboard BIOS.

### *Advanced Features Menu*

```
Advanced Features

Flash Type -- SST 29EE010
Current BIOS Revision: #401A0-xxxx
Choose one of the following:
1. Clear PNP ESCD Parameter Block
2. Update BIOS Including Boot Block and ESCD

Enter Choice: [ 2]

Press ESC To Exit
```

xxxx denotes the current BIOS version stored in the Flash EPROM

### 1. Clear PNP ESCD Parameter Block

This option erases the Plug-and-Play (PnP) configuration record.

### 2. Update BIOS Including Boot Block and ESCD

This option updates the Boot Block, the motherboard BIOS and the PnP ESCD Parameter Block from a new BIOS file.

**NOTE:** "Update BIOS Main Block from File" and "Update BIOS Including Boot Block and ESCD" requires that the system is running in real mode. This utility will not operate if the system is under protected mode or virtual mode. You should boot from a system floppy diskette without "AUTOEXEC.BAT" and "CONFIG.SYS" files.

# IV. BIOS SOFTWARE

---

## Updating your Motherboard's BIOS

1. Download an updated BIOS file from Bulletin Board Services (BBS) or the internet (WWW) and save to the diskette you created in step 1 of the Main Menu. See **ASUS CONTACT INFORMATION** on page II.
2. Turn off your computer and open the system cabinet to *Enable* "Boot Block Programming" jumper as shown in section III.
2. Boot from the floppy diskette you created in step 1 of the main menu.
3. At the "A:\\" prompt, type: **PFLASH <Enter>**
4. Enter "2" from the Main Menu or "2" from the Advanced Features Menu.
5. The program displays a second screen prompting you for the name of the BIOS file. Type in the complete name of the file, including the file name extension, and then press the <Enter> key. The utility then uploads the BIOS file from disk. The following message will appear:

**DO NOT TURN OFF THE SYSTEM IF THERE IS A PROBLEM!**

If you encounter problems while downloading the new BIOS, **DO NOT** turn off your system since this might prevent your system from booting up. Just repeat the process, and if the problem still persists, upload the original BIOS file you saved to disk in step 1 of the Main Menu.

**WARNING:** If the Flash Memory Writer utility was not able to successfully download a complete BIOS file, your system may not be able to boot up. If this happens, your system will require service from your vendor.

6. After successfully downloading the new BIOS file, exit the Flash Memory Writer utility and **then turn off your system**. Set the jumper back to its default setting of Programming "*Disabled.*"
7. Turn on your computer and hold down <delete> to enter BIOS setup. **You must select "Setup Default" to affect the new BIOS, then you may set other items from the Main Menu.**

# IV. BIOS SOFTWARE

## 6. BIOS Setup

The motherboard supports two programmable Flash ROM chips: 5 Volt and 12 Volt. Either of these memory chips can be updated when BIOS upgrades are released. Use the Flash Memory Writer utility to download the new BIOS file into the ROM chip as described in detail in this section.

All computer motherboards provide a Setup utility program for specifying the system configuration and settings. If your motherboard came in a computer system, the proper configuration entries may have already been made. If so, invoke the Setup utility, as described later, and take note of the configuration settings for future reference; in particular, the hard disk specifications.

If you are installing the motherboard, reconfiguring your system or you receive a Run Setup message, you will need to enter new setup information. This section describes how to configure your system using this utility.

The BIOS ROM of the system stores the Setup utility. When you turn on the computer, the system provides you with the opportunity to run this program. This appears during the Power-On Self Test (POST). Press the <Delete> key to call up the Setup utility. If you are a little bit late pressing the mentioned key(s), POST will continue with its test routines, thus preventing you from calling up Setup. If you still need to call Setup, reset the system by simultaneously pressing the <Ctrl>, <Alt> and <Delete> keys, or by pushing the Reset button on the system case. You can also restart by turning the system off and then back on again. But do so only if the first two methods fail.

When you invoke Setup, the CMOS SETUP UTILITY main program screen will appear with the following options:

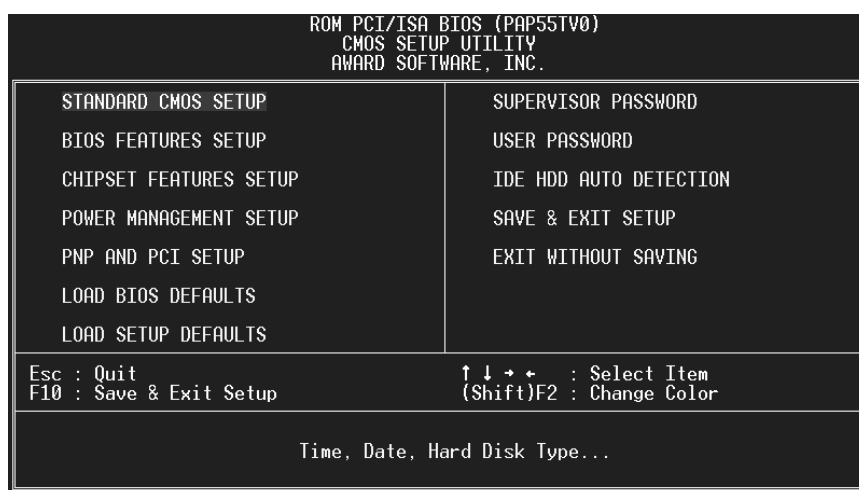

# IV. BIOS SOFTWARE

## Load Defaults

The “Load BIOS Defaults” option loads the minimized settings for troubleshooting. “**Load Setup Defaults**”, on the other hand, is for loading optimized defaults for regular use. Choosing defaults at this level, will modify all applicable settings.

A section at the bottom of the above screen displays the control keys for this screen. Take note of these keys and their respective uses. Another section just below the control keys section displays information on the currently highlighted item in the list.

## Standard CMOS Setup

This “Standard CMOS Setup” option allows you to record some basic system hardware configuration and set the system clock and error handling. If the motherboard is already installed in a working system, you will not need to select this option anymore. However, if the configuration stored in the CMOS memory on the board gets lost or damaged, or if you change your system hardware configuration, you will need to respecify the configuration values. The configuration values usually get lost or corrupted when the power of the onboard CMOS battery weakens.

```
ROM PCI/ISA BIOS (PAP55TV0)
STANDARD CMOS SETUP
AWARD SOFTWARE, INC.

Date (mm:dd:yy) : Tue, Oct 29 1996
Time (hh:mm:ss) : 11 : 32 : 2

HARD DISKS      TYPE  SIZE  CYLS  HEAD  PRECOMP  LANDZ  SECTOR  MODE
-----
Primary Master  : Auto   0      0    0      0      0      0  AUTO
Primary Slave   : None   0      0    0      0      0      0  -----
Secondary Master: Auto   0      0    0      0      0      0  AUTO
Secondary Slave : None   0      0    0      0      0      0  -----

Drive A : 1.44M, 3.5 in.
Drive B : None
Floppy 3 Mode Support : Disabled

Video : EGA/VGA
Halt On : All Errors

Base Memory: 640K
Extended Memory: 64512K
Other Memory: 384K
-----
Total Memory: 65536K

ESC : Quit          ↑ ↓ → ← : Select Item      PU/PD/+/- : Modify
F1  : Help          (Shift)F2 : Change Color
```

IV. BIOS  
(Standard CMOS)

The above screen provides you with a list of options. At the bottom of this screen are the control keys for use on this screen. Take note of these keys and their respective uses.

User-configurable fields appear in a different color. If you need information on the selected field, press the <F1> key. The help menu will then appear to provide you with the information you need. The memory display at the lower right-hand side of the screen is read-only and automatically adjusts accordingly.

## IV. BIOS SOFTWARE

---

### *Details of Standard CMOS Setup:*

#### **Date**

To set the date, highlight the “Date” field and then press the page up/page down or +/- keys to set the current date. Follow the month, day and year format. Valid values for month, day and year are:

<b>Month:</b>	<b>1 to 12</b>
<b>Day:</b>	<b>1 to 31</b>
<b>Year:</b>	<b>up to 2099</b>

#### **Time**

To set the time, highlight the “Time” field and then press the page up/page down or +/- keys to set the current time. Follow the hour, minute and second format. Valid values for hour, minute and second are:

<b>Hour:</b>	<b>00 to 23</b>
<b>Minute:</b>	<b>00 to 59</b>
<b>Second:</b>	<b>00 to 59</b>

You can bypass the date and time prompts by creating an AUTOEXEC.BAT file. For information on how to create this file, please refer to the MS-DOS manual.

#### **Hard Disk Drives**

This field records the specifications for all non-SCSI hard disk drives installed in your system. The onboard PCI IDE connectors provide Primary and Secondary channels for connecting up to four IDE hard disks or other IDE devices. Each channel can support up to two hard disks; the first of which is the “master” and the second is the “slave”.

Specifications for SCSI hard disks need not to be entered here since they operate using device drivers and are not supported by any the BIOS. If you install the optional PCI-SC200 SCSI controller card into the motherboard (see section VI for instructions). If you install other vendor’s SCSI controller card, please refer to their respective documentations on how to install the required SCSI drivers.

To enter specifications for a hard disk drive, you must select first a “type”. You can select “User” and specify the specifications yourself manually, or you can select from the provided predefined drive specifications. To select, simply press the <Page Up> or <Page Down> key to change the option listed after the drive letter.

# IV. BIOS SOFTWARE

---

## For IDE hard disk drive setup, you can:

- Use the *Auto* setting for detection during bootup.
- Use the IDE HDD AUTO DETECTION in the main menu to automatically enter the drive specifications.
- Enter the specifications yourself manually by using the "User" option.

The entries for specifying the hard disk type include **CYLS** (number of cylinders), **HEAD** (number of read/write heads), **PRECOMP** (write precompensation), **LANDZ** (landing zone), **SECTOR** (number of sectors) and **MODE**. The **SIZE** field automatically adjusts according to the configuration you specify. The documentation that comes with your hard disk should provide you with the information regarding the drive specifications.

The **MODE** entry is for IDE hard disks only, and can be ignored for MFM and ESDI drives. This entry provides three options: *Normal*, *Large*, *LBA*, or *Auto* (see below). Set **MODE** to the *Normal* for IDE hard disk drives smaller than 528MB; set it to *LBA* for drives over 528MB that support Logical Block Addressing (LBA) to allow larger IDE hard disks; set it to *Large* for drives over 528MB that do not support LBA. *Large* type of drive can only be used with MS-DOS and is very uncommon. Most IDE drives over 528MB support the *LBA* mode.

## Auto detection of hard disks on bootup

For each field: Primary Master, Primary Slave, Secondary Master, and Secondary Slave, you can select *Auto* under the TYPE and MODE fields. This will enable auto detection of your IDE drives during bootup. This will allow you to change your hard drives (with the power off) and then power on without having to reconfigure your hard drive type. If you use older hard drives which do not support this feature, then you must configure the hard drive in the standard method as described above by the "User" option.

**NOTE:** After the IDE hard disk drive information has been entered into BIOS, new IDE hard disk drives must be partitioned (such as with FDISK) and then formatted before data can be read from and write on. Primary IDE hard disk drives must have its partition set to *active* (also possible with FDISK).

**NOTE:** SETUP Defaults are noted in parenthesis next to each function heading.

# IV. BIOS SOFTWARE

---

## **Drive A / Drive B (None)**

These fields record the types of floppy disk drives installed in your system. The available options for drives A and B are: *360KB, 5.25 in.; 1.2MB, 5.25 in.; 720KB, 3.5 in.; 1.44MB, 3.5 in.; 2.88MB, 3.5 in.; None*

To enter the configuration value for a particular drive, highlight its corresponding field and then select the drive type using the left- or right-arrow key.

## **Floppy 3 Mode Support (Disabled)**

This is the Japanese standard floppy drive. The standard stores 1.2MB in a 3.5" diskette. This is normally disabled but you may choose from either: *Drive A, Drive B, Both, and Disabled*

## **Video (EGA/VGA)**

Set this field to the type of video display card installed in your system. The options are: *EGA/VGA, Mono (for Hercules or MDA), CGA 40, and CGA 80*

If you are using a VGA or any higher resolution card, choose the "EGA/VGA" option.

## **Halt On (All Errors)**

This field determines which types of errors will cause the system to halt. Choose from: *All Errors, No Errors, All, But Keyboard, All, But Diskette, and All, But Disk/Key*

# IV. BIOS SOFTWARE

## BIOS Features Setup

This “BIOS Features Setup” option consists of configuration entries that allow you to improve your system performance, or let you set up some system features according to your preference. Some entries here are required by the motherboard’s design to remain in their default settings.

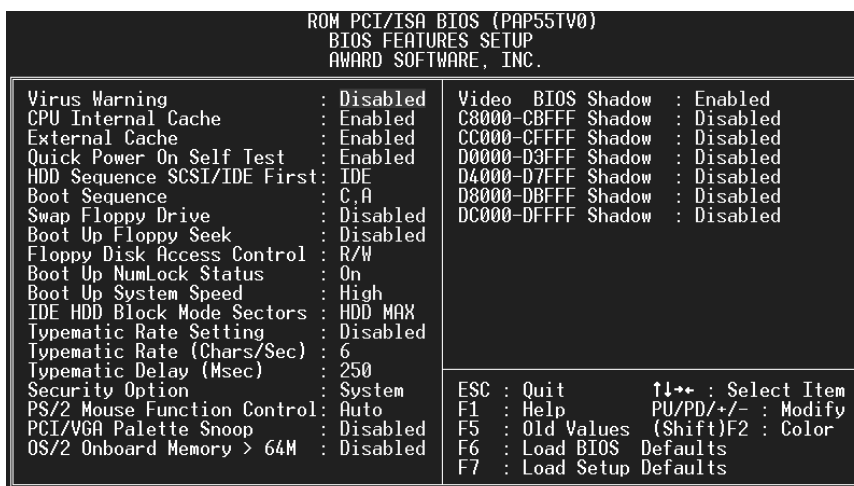

A section at the lower right of the screen displays the control keys you can use. Take note of these keys and their respective uses. If you need information on a particular entry, highlight it and then press the <F1> key. A pop-up help menu will appear to provide you with the information you need. To load the last set values, press the <F5> key. <F6> and <F7> load the BIOS default values and Setup default values, respectively.

**NOTE:** SETUP Defaults are noted in parenthesis next to each function heading.

### *Details of BIOS Features Setup*

#### **Virus Warning (Disabled)**

This field protects the boot sector and partition table of your hard disk against accidental modifications. Any attempt to write to them will cause the system to halt and display a warning message. If this occurs, you can either allow the operation to continue or use a bootable virus-free floppy disk to reboot and investigate your system. This setting is recommended because conflicts with new operating systems. Installation of new operating systems require that you disable this to prevent write errors.

#### **CPU Internal Cache (Enabled)**

These fields allow you to *Enable* or *Disable* the CPU’s “Level 1” primary cache. Caching allows better performance.



# IV. BIOS SOFTWARE

---

## **External Cache (Enabled)**

These fields allow you to *Enable* or *Disable* the CPU's "Level 2" secondary cache. Caching allows better performance.

## **Quick Power On Self Test (Enabled)**

This field speeds up the Power-On Self Test (POST) routine by skipping retesting a second, third, and fourth time. Setup default setting for this field is *Enabled*. A complete test of the system is done on each test.

## **HDD Sequence SCSI/IDE First (New Feature!)**

When using both SCSI and IDE hard disk drives, IDE is always the boot disk using drive letter C (default setting of *IDE*). This new feature allows a SCSI hard disk drive to be the boot disk when set to *SCSI*. This allows multiple operating systems to be used on both IDE and SCSI drives or the primary operating system to boot using a SCSI hard disk drive.

## **Boot Sequence (C,A)**

This field determines where the system looks first for an operating system. Options are *C,CDROM,A*; *CDROM,C,A*; *A,C*; *C,A*. The setup default setting is to check first the hard disk and then the floppy drive; that is, *C, A*.

## **Swap Floppy Drive (Disabled)**

When enabled, the BIOS swaps floppy drive assignments so that Drive A becomes Drive B, and Drive B becomes Drive A under DOS.

## **Boot Up Floppy Seek (Disabled)**

When enabled, the BIOS will seek the floppy "A" drive one time.

## **Floppy Disk Access Control (R/W)**

This allows protection of files from the computer system to be copied to floppy drives by allowing the setting of *Read Only* to only allow reads from the floppy but not writes. The setup default *R/W* allows both reads and writes.

## **Boot Up NumLock Status (On)**

This field enables users to activate the Number Lock function upon system boot.

## **Boot Up System Speed (High)**

This has no function and should be left on the setup default.

## **IDE HDD Block Mode Sectors (HDD MAX)**

This field enhances hard disk performance by making multi-sector transfers instead of one sector per transfer. Most IDE drives, except older versions, can utilize this feature. Selections are *HDD MAX*, *Disabled*, *2*, *4*, *8*, *16*, and *32*.

# IV. BIOS SOFTWARE

---

## **Typematic Rate Setting (Disabled)**

When enabled, you can set the two typematic controls listed next. Setup default setting is *Disabled*.

## **Typematic Rate (Chars/Sec)**

This field controls the speed at which the system registers repeated keystrokes. Options range from 6 to 30 characters per second. Setup default setting is **6**; other settings are *8, 10, 12, 15, 20, 24, and 30*.

## **Typematic Delay (Msec) (250ms)**

This field sets the time interval for displaying the first and second characters. Four delay rate options are available: 250ms, 500ms, 750ms and 1000ms.

## **Security Option (System)**

This field determines when the system prompts for the password. The default setting is *System*, where the system prompts for the User Password every time you boot up. The other option is *Setup*, where the system always boots up, and prompts for the Supervisor Password only when the Setup utility is called up. You can specify a password by using the *Supervisor Password* or *User Password* option from the main screen as explained later in this section.

## **PS/2 Mouse Function Control (Auto)**

The default of *Auto* allows the system to detect a PS/2 Mouse on bootup. If detected, IRQ12 will be used for the PS/2 Mouse. IRQ12 will be reserved for expansion cards if a PS/2 Mouse is not detected. *Disabled* will reserve IRQ12 for expansion cards and therefore the PS/2 Mouse will not function.

## **PCI/VGA Palette Snoop (Disabled)**

Some display cards that are nonstandard VGA such as graphics accelerators or MPEG Video Cards may not show colors properly. The setting *Enabled* should correct this problem. Otherwise leave this on the setup default setting of *Disabled*.

## **OS/2 Onboard Memory > 64M (Disabled)**

When using OS/2 operating systems with installed DRAM of greater than 64MB, you need to *Enable* this option otherwise leave this on the setup default of *Disabled*.

.....

## **Video BIOS Shadow (Enabled)**

This field allows you to change the video BIOS location from ROM to RAM. Relocating to RAM enhances system performance, as information access is faster than the ROM.

## **C8000-CBFFF to DC000-DFFFF (Disabled)**

These fields are used for shadowing other expansion card ROMs. If you install other expansion cards with ROMs on them, you will need to know which addresses the ROMs use to shadow them specifically. Shadowing a ROM reduces the memory available between 640KB and 1024KB by the amount used for this purpose.

# IV. BIOS SOFTWARE

## Chipset Features Setup

This “Chipset Features Setup” option controls the configuration of the board’s chipset. Control keys for this screen are the same as for the previous screen.

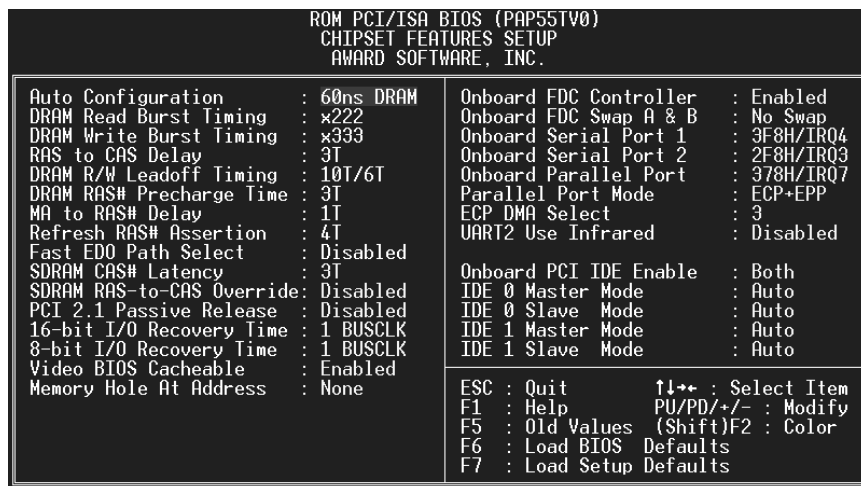

**NOTE:** SETUP Defaults are noted in parenthesis next to each function heading.

### *Details of Chipset Features Setup*

#### **Auto Configuration (60ns DRAM)**

The default setting of *60ns DRAM* sets the optimal timings for items 2 through 9 for 60ns DRAM modules. If you are using 70ns DRAM modules, you must change this item to *70ns DRAM*. See section III for DRAM installation information.

#### **SDRAM CAS# Latency (Leave on default setting of 3T)**

#### **SDRAM RAS-to-CAS Override (Leave on default setting of Disabled)**

#### **PCI 2.1 Passive Release (Leave on default setting of Disabled)**

#### **16-bit I/O Recovery Time (1 BUSCLK)**

Timing for 16-bit ISA cards

#### **8-bit I/O Recovery Time (1 BUSCLK)**

Timing for 8-bit ISA cards

#### **Video BIOS Cacheable (Enabled)**

Allows the Video BIOS to be cached to allow faster execution. Leave on default setting of *Enabled* for better performance. (Otherwise *Disabled*)

# IV. BIOS SOFTWARE

---

## Memory Hole at Address (None)

This feature reserves either *14MB-16MB* or *15MB-16MB* memory address space to ISA expansion cards that specifically require this setting. Memory from 14MB and up or 15MB and up will be unavailable to the system because expansion cards can only access memory up to 16MB.

.....

## Onboard FDC Controller (Enabled)

When enabled, this field allows you to connect your floppy disk drives to the on-board floppy drive connector instead of a separate controller card. If you want to use a different controller card to connect the floppy drives, set this field to *Disabled*.

## Onboard FDC Swap A: B: (No Swap)

This field reverses the drive letter assignments of your floppy disk drives. Two options are available: *No Swap* and *Swap AB*. If you want to switch drive letter assignments, set this field to *Swap AB*, and the swap will be controlled in hardware. This works separately from the BIOS Features floppy disk swap feature. It is functionally the same as physically interchanging the connectors of the floppy disk drives.

## Onboard Serial Port 1 (3F8H/IRQ4)

Settings are *3F8H/IRQ4*, *2F8H/IRQ3*, *3E8H/IRQ4*, *2E8H/IRQ10*, and *Disabled* for the onboard serial connector.

## Onboard Serial Port 2 (2F8H/IRQ3)

Settings are *3F8H/IRQ4*, *2F8H/IRQ3*, *3E8H/IRQ4*, *2E8H/IRQ10*, and *Disabled* for the onboard serial connector.

## Onboard Parallel Port (378H/IRQ7)

This field sets the address of the onboard parallel port connector. You can select either: *3BCH / IRQ 7*, *378H / IRQ 7*, *278H / IRQ 5*, *Disabled*. If you install an I/O card with a parallel port, ensure that there is no conflict in the address assignments. The PC can support up to three parallel ports as long as there are no conflicts for each port.

## Parallel Port Mode (ECP+EPP)

This field allows you to set the operation mode of the parallel port. The setting *Normal*, allows normal-speed operation but in one direction only; *EPP* allows bidirectional parallel port operation at maximum speed; *ECP* allows the parallel port to operate in bidirectional mode and at a speed faster than the maximum data transfer rate; *ECP+EPP* allows normal speed operation in a two-way mode.

## IV. BIOS SOFTWARE

---

### **ECP DMA Select (3)**

This selection is available only if you select *ECP* or *ECP+EPP* in the **Parallel Port Mode**. Select either DMA Channel *1, 3*, or *Disable*.

### **UART2 Use Infrared (Disabled)**

When enabled, this field activates the onboard infrared feature and sets the second serial UART to support the infrared module connector on the motherboard. If your system already has a second serial port connected to the onboard COM2 connector, it will no longer work if you enable the infrared feature. By default, this field is set to *Disabled*, which leaves the second serial port UART to support the COM2 serial port connector. See section III of the baseboard manual for the **IrDA-compliant infrared module connector**.

### **Onboard PCI IDE Enable (Both)**

You can select to enable the *Primary* IDE channel, *Secondary* IDE channel, *Both*, or *Disable* both channels (for systems with only SCSI drives).

### **IDE 0 Master/Slave Mode, IDE 1 Master/Slave Mode (Auto)**

Each channel (0 and 1) has both a master and a slave making four IDE devices possible. Because each IDE device may have a different Mode timing (*0, 1, 2, 3, 4*), it is necessary for these to be independent. The default setting of *Auto* will allow auto-detection to ensure optimal performance.

# IV. BIOS SOFTWARE

## Power Management Setup

This "Power Management Setup" option allows you to reduce power consumption. This feature turns off the video display and shuts down the hard disk after a period of inactivity.

```
ROM PCI/ISA BIOS (PAP55TV0)
POWER MANAGEMENT SETUP
AWARD SOFTWARE, INC.

Power Management      : User Define
Video Off Option     : Susp.Stby -> Off
Video Off Method     : V/H SYNC+Blank
Suspend Switch       : Enable
Doze Speed (div by) : 8
Stdbby Speed(div by): 32

** PM Timers **
HDD Power Down      : Disable
Doze Mode           : Disable
Standby Mode        : Disable
Suspend Mode        : Disable

** PM Events **
IRQ3 (Wake-Up)     : Disable
IRQ4 (Wake-Up)     : Enable
IRQ8 (Wake-Up)     : Disable
IRQ12 (Wake-Up)    : Enable

IRQ3 (COM 2)       : Disable
IRQ4 (COM 1)       : Enable
IRQ5 (LPT 2)       : Enable
IRQ6 (Floppy Disk) : Enable
IRQ7 (LPT 1)       : Enable
IRQ8 (RTC Alarm)   : Disable
IRQ9 (IRQ2 Redir)  : Enable
IRQ10 (Reserved)   : Enable
IRQ11 (Reserved)   : Enable
IRQ12 (PS/2 Mouse) : Enable
IRQ13 (Coprocesor) : Enable
IRQ14 (Hard Disk)  : Enable
IRQ15 (Reserved)   : Enable

ESC : Quit          ↑↓+* : Select Item
F1  : Help          PU/PD/+/- : Modify
F5  : Old Values    (Shift)F2 : Color
F6  : Load BIOS Defaults
F7  : Load Setup Defaults
```

**NOTE:** SETUP Defaults are noted in parenthesis next to each function heading.

### Details of Power Management Setup

#### Power Management (User Defined)

This field acts as the master control for the power management modes. *Max Saving* puts the system into power saving mode after a brief period of system inactivity; *Min Saving* is almost the same as *Max Saving* except that this time the system inactivity period is longer; *Disabled* disables the power saving features; *User Defined* allows you to set power saving options according to your preference.

**IMPORTANT:** Advanced Power Management (APM) should be installed to keep the system time updated when the computer enters suspend mode activated by the BIOS Power Management. For DOS environments, you need to add `DEVICE=C:\DOS\POWER.EXE` in you `CONFIG.SYS`. For Windows 3.x and Windows 95, you need to install Windows with the APM feature. A battery and power cord icon labeled "Power" will appear in the "Control Panel." Choose "Advanced" in the Power Management Field.

#### Video Off Option (Susp, Stby->Off)

This field determines when to activate the video off feature for monitor power management. The settings are *Susp, Stby->Off*, *Suspend->Off*, *Always on*, and *All modes->off*.

# IV. BIOS SOFTWARE

---

## **Video Off Method (V/H SYNC + Blank)**

This field defines the video off features. Three options are available: *V/H SYNC + Blank*, *DPMS*, and *Blank Only*. The first option, which is the default setting, blanks the screen and turns off vertical and horizontal scanning; *DPMS* (Display Power Management System) allows the BIOS to control the video display card if it supports the DPMS feature; *Blank Screen* only blanks the screen. Use the latter for monitors that do not support the “Green” (no power management) feature. NOTE: Screen saver software does not work with this feature. While the monitor is shut off, this software cannot display.

## **Suspend Switch (Enabled)**

This field enables or disables the SMI connector on the motherboard. This connector connects to the lead from the Suspend switch mounted on the system case.

## **Doze Speed, Stdby Speed**

These two fields set the CPU speed during each mode. The number indicates what the normal CPU speed is divided by.

## **PM Timers**

This section controls the time-out settings for the Power Management scheme. The fields included in this section are “HDD Power Down”, which places the hard disk into its lowest power consumption mode, and the Doze, Standby and Suspend system inactivation modes.

The system automatically “wakes up” from any power saving mode when there is system activity such as when a key is pressed from the keyboard, or when there is activity detected from the enabled IRQ channels.

**HDD Power Down** shuts down any IDE hard disk drives in the system after a period of inactivity. This time period is user-configurable to *1-15 Mins* or *Disable*. This feature does not affect SCSI hard drives.

The **Doze Mode**, **Standby Mode**, and **Suspend Mode** fields set the period of time after which each of these modes activate. At *Max Saving*, these modes activate sequentially (in the given order) after one minute; at *Min Saving* after one hour.

## **PM Events**

This section sets the wake-up call of the system. If activity is detected from any enabled IRQ channels in the left-hand group, the system wakes up from suspended mode. You can enable power management for IRQs 3 ~ 15 individually in the list at the right of the screen. The power management feature will work on the enabled IRQ channels.

Take note that a Microsoft serial mouse or compatible will use either COM1 (IRQ4) or COM2 (IRQ3), and a PS/2 mouse will use IRQ12. If you know which IRQ your mouse is using, you can enable the Wake-up Event for that IRQ here and the system will wake up when you move the mouse or click its button.

.....

## **Sleep Items (IRQ3-IRQ15)**

You can individually *Enable* or *Disable* each IRQ to include in the sleep function. IRQ8 (Real Time Alarm) is usually set to *Disable* so that any software alarm clock or event calendar can wake up the system.

# IV. BIOS SOFTWARE

## PNP and PCI Setup

This “PNP and PCI Setup” option configures the PCI bus slots. All PCI bus slots on the system use INTA#, thus all installed PCI cards must be set to this value.

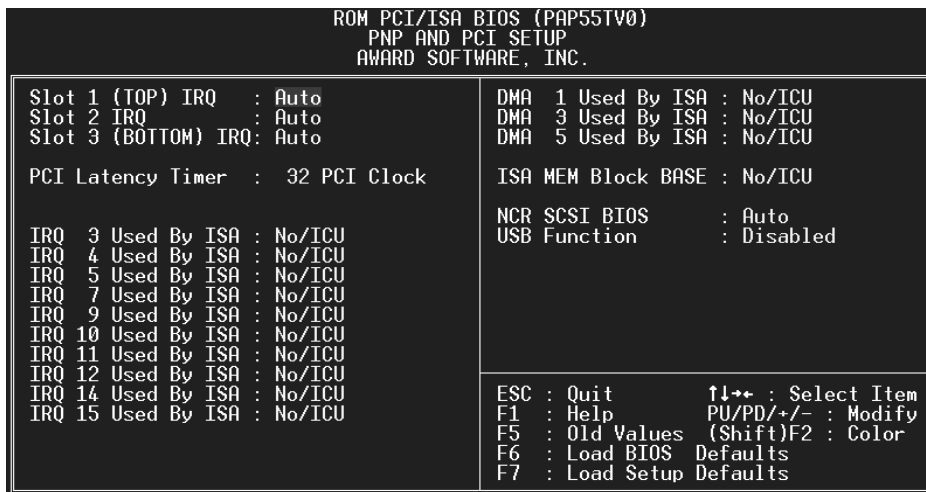

**NOTE:** SETUP Defaults are noted in parenthesis next to each function heading.

### Details of PNP and PCI Setup

#### [Slot Interrupts] (Auto)

The first four fields on the screen set how IRQ use is determined for each PCI slot. Slot 1 (Right) is nearest the memory sockets. The default setting for each field is *Auto*, which uses auto-routing to determine IRQ use. The other options are manual settings of *NA*, *9*, *10*, *11*, *12*, *14*, or *15* for each slot.

#### PCI Latency Timer (32 PCI Clock)

"32 PCI Clock" enables maximum PCI performance for this motherboard.

#### IRQ xx Used By ISA (No/ICU)

These fields indicate whether or not the displayed IRQ for each field is being used by a Legacy (non-PnP) ISA card. Two options are available: *No/ICU* and *Yes*. The first option, the default value, indicates either that the displayed IRQ is not used or an ISA Configuration Utility (ICU) is being used to determine if an ISA card is using that IRQ. If you install a Legacy ISA card that requires a unique IRQ, and you are not using an ICU, you must set the field for that IRQ to *Yes*. For example: If you install a Legacy ISA card that requires IRQ 10, then set **IRQ10 Used By ISA** to *Yes*.

.....



## IV. BIOS SOFTWARE

---

### **DMA x Used By ISA (No/ICU)**

These fields indicate whether or not the displayed DMA channel for each field is being used by a Legacy (non-PnP) ISA card. Available options include: *No/ICU* and *Yes*. The first option, the default setting, indicates either that the displayed DMA channel is not used or an ICU is being used to determine if an ISA card is using that channel. If you install a Legacy ISA card that requires a unique DMA channel, and you are not using an ICU, you must set the field for that channel to *Yes*.

### **ISA MEM Block BASE (No/ICU)**

This field allows you to set the base address and block size of a Legacy ISA card that uses any memory segment within the C800H and DFFFH address range. If you have such a card, and you are not using an ICU to specify its address range, select a base address from the six available options; the **ISA MEM Block SIZE** field will then appear for selecting the block size. If you have more than one Legacy ISA card in your system that requires to use this address range, you can increase the block size to either 8K, 16K, 36K, or 64K. If you are using an ICU to accomplish this task, leave **ISA MEM Block BASE** to its default setting of *No/ICU*.

### **NCR SCSI BIOS (Auto)**

The default uses *Auto* settings for the onboard NCR SCSI BIOS (see section VI). If you wish not to use the onboard NCR SCSI BIOS, choose *Disabled*

### **USB Function (Disabled)**

This motherboard supports Universal Serial Bus (USB) devices but current operating systems do not. The default is set to *Disabled* until support disks and USB devices are available in which time you can set this function to *Enabled*.

# IV. BIOS SOFTWARE

## Load BIOS Defaults

This “Load BIOS Defaults” option allows you to load the troubleshooting default values permanently stored in the BIOS ROM. These default settings are non-optimal and disable all high performance features. To load these default settings, highlight “Load BIOS Defaults” on the main screen and then press the <Enter> key. The system displays a confirmation message on the screen. Press the <Y> key and then the <Enter> key to confirm. Press the <N> key and then the <Enter> key to abort. This feature does not affect the fields on the Standard CMOS Setup screen.

## Load Setup Defaults

This “Load Setup Defaults” option allows you to load the default values to the system configuration fields. These default values are the optimized configuration settings for the system. To load these default values, highlight “Load Setup Defaults” on the main screen and then press the <Enter> key. The system displays a confirmation message on the screen. Press the <Y> key and then the <Enter> key to confirm. Press the <N> key and then the <Enter> key to abort. This feature does not affect the fields on the Standard CMOS Setup screen.

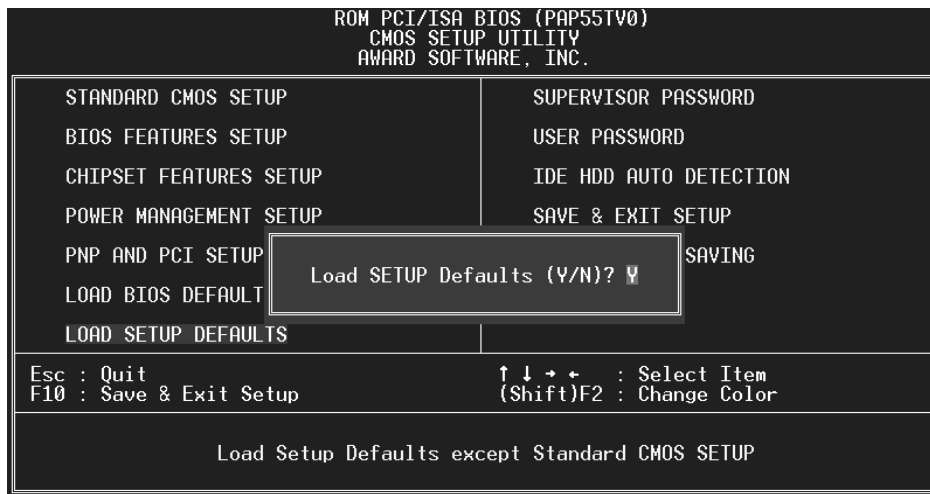

# IV. BIOS SOFTWARE

## Supervisor Password and User Password

These two options set the system passwords. “Supervisor Password” sets a password that will be used to protect the system and the Setup utility; “User Password” sets a password that will be used exclusively on the system. By default, the system comes without any passwords. To specify a password, highlight the type you want and then press the <Enter> key. A password prompt appears on the screen. Taking note that the password is case sensitive, and can be up to 8 alphanumeric characters long, type in your password and then press the <Enter> key. The system confirms your password by asking you to type it again. After setting a password, the screen automatically reverts to the main screen.



To implement the password protection, specify in the “Security Option” field of the BIOS Features Setup screen when the system will prompt for the password. If you want to disable either password, press the <Enter> key instead of entering a new password when the “Enter Password” prompt appears. A message confirms the password has been disabled.

**NOTE:** If you forget the password, see CMOS RAM in section III for procedures on clearing the CMOS.

# IV. BIOS SOFTWARE

## IDE HDD Auto Detection

This “IDE HDD Auto Detection” option detects the parameters of an IDE hard disk drive, and automatically enters them into the Standard CMOS Setup screen.

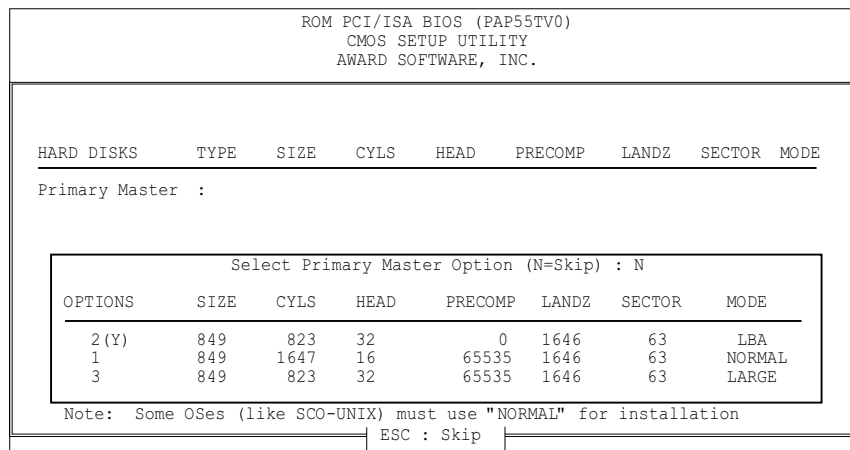

Up to four IDE drives can be detected, with parameters for each listed inside the box. To accept the optimal entries, press the <Y> key or else select from the numbers displayed under the OPTIONS field (2, 1, 3 in this case); to skip to the next drive, press the <N> key. If you accept the values, the parameters will appear listed beside the drive letter on the screen. The process then proceeds to the next drive letter. Pressing the <N> key to skip rather than to accept a set of parameters causes the program to enter zeros after that drive letter.

Remember that if you are using another IDE controller that does not feature Enhanced IDE support for four devices, you can only install two IDE hard disk drives. Your IDE controller must support the Enhanced IDE features in order to use Drive E and Drive F. The onboard PCI IDE controller supports Enhanced IDE, with two connectors for connecting up to four IDE devices. If you want to use another controller that supports four drives, you must disable the onboard IDE controller in the Chipset Features Setup screen.

When auto-detection is completed, the program automatically enters all entries you accepted on the field for that drive in the Standard CMOS Setup screen. Skipped entries are ignored and are not entered in the screen.

If you are auto-detecting a hard disk that supports the LBA mode, three lines will appear in the parameter box. Choose the line that lists LBA for an LBA drive. Do not select Large or Normal.

The auto-detection feature can only detect one set of parameters for a particular IDE hard drive. Some IDE drives can use more than one set. This is not a problem if the drive is new and there is nothing on it.

## IV. BIOS SOFTWARE

**IMPORTANT:** If your hard drive was already formatted on an older previous system, incorrect parameters may be detected. You will need to enter the correct parameters manually or use low-level format if you do not need the data stored on the hard drive.

If the parameters listed differ from the ones used when the drive was formatted, the drive will not be readable. If the auto-detected parameters do not match the ones that should be used for your drive, do not accept them. Press the <N> key to reject the presented settings and enter the correct ones manually from the Standard CMOS Setup screen.

### Save and Exit Setup

Select this option to save into the CMOS memory all modifications you specify during the current session. To save the configuration changes, highlight the “Save & Exit Setup” option on the main screen and then press the <Enter> key.

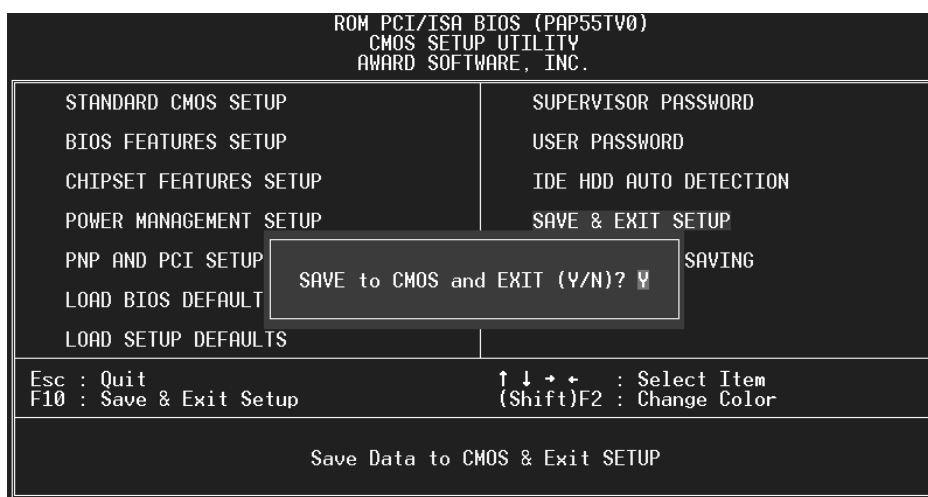

IV. BIOS  
(Save & Exit)

### Exit Without Saving

Select this option to exit the Setup utility without saving the modifications you specify during the current session. To exit without saving, highlight the “Exit Without Saving” option on the main screen and then press the <Enter> key.

---

(This page was intentionally left blank)

# V. DESKTOP MANAGEMENT

---

## Desktop Management Interface (DMI)

### *Introducing the ASUS DMI Configuration Utility*

This motherboard supports DMI within the BIOS level and provides a DMI Configuration Utility to maintain the Management Information Format Database (MIFD). DMI is able to auto-detect and record information pertinent to a computer's system such as the CPU type, CPU speed, and internal/external frequencies, and memory size. The onboard BIOS will detect as many system information as possible and store those collected information in a 4KB block in the motherboard's Flash EPROM and allow the DMI to retrieve data from this database. Unlike other BIOS software, the BIOS on this motherboard uses the same technology implemented for Plug and Play to allow dynamic real-time updating of DMI information versus creating a new BIOS image file and requiring the user to update the whole BIOS. This DMI Configuration Utility also allows the system integrator or end user to add additional information into the MIFD such as serial numbers, housing configurations, and vendor information. Those information not detected by the motherboard BIOS and has to be manually entered through the DMI Configuration Utility and updated into the MIFD. This DMI Configuration Utility provides the same reliability as PnP updating and will prevent the refreshing failures associated with updating the entire BIOS.

### *System Requirements*

The motherboard BIOS must support DMI. The following motherboards do not support DMI:

- P/I-P6RP4 (not supported)
- PCI/E-P54NP4 (not supported)
- PCI/I-P54NP4D (not supported)

The DMI Configuration Utility (DMICFG.EXE) must be ran in real mode in order for the program to run, the base memory must be at least 180K. Memory managers like HIMEM.SYS (required by windows) must not be installed. You can boot up from a system diskette without AUTOEXEC.BAT and CONFIG.SYS files, "REM" HIMEM.SYS in the CONFIG.SYS, or press <F5> during bootup to bypass your AUTOEXEC.BAT and CONFIG.SYS files.

# V. DESKTOP MANAGEMENT

## Using the ASUS DMI Configuration Utility

### Edit DMI (or delete)

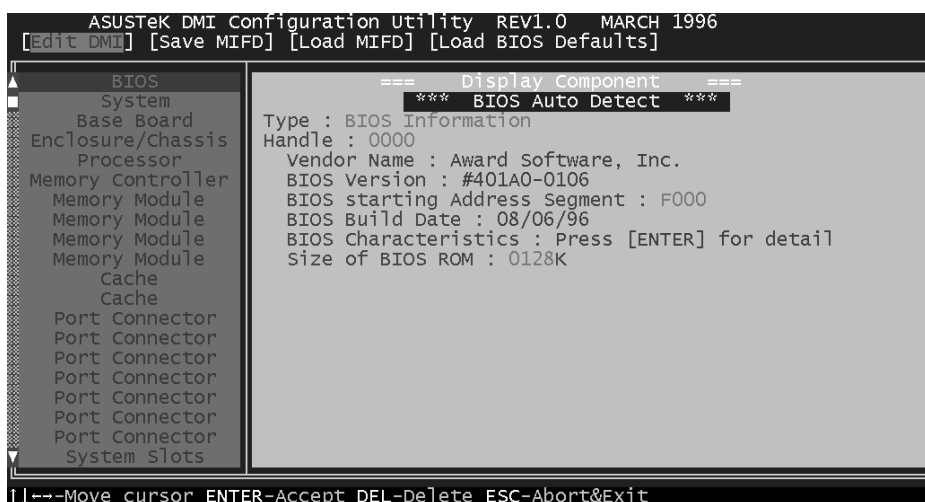

Use the ←→ (left-right) cursors to move the top menu items and the ↑↓ (up-down) cursor to move between the left hand menu items. The bottom of the screen will show the available keys for each screen. Press enter at the menu item to enter the right hand screen for editing. “Edit component” appears on top. The reversed color field is the current cursor position and the blue text are available for editing. The orange text shows auto-detected information and are not available for editing. The blue text “Press [ENTER] for detail” contains a second pop-up menu is available, use the + - (plus-minus) keys to change the settings. Enter to exit *and save*, ESC to exit *and not save*.

If the user has made changes, ESC will prompt you to answer Y or N. Enter Y to go back to the left-hand screen *and save*, enter N to go back to left-hand screen and *not save*. If editing has not been made, ESC will send you back to the left hand menu without any messages.

### Notes:

A heading, \*\*\* BIOS Auto Detect \*\*\* appears on the right for each menu item on the left side that has been auto detected by the system BIOS.

A heading, \*\*\* User Modified \*\*\* will appear on the right for menu items that has been modified by the user.





# V. DESKTOP MANAGEMENT

---

## Save MIFD



## Load MIFD



## Load BIOS Defaults



---

(This page was intentionally left blank)

# VI. Microsoft Windows 95

## Video Driver Installation

### Introduction

After installing the ASUS Video or Audio/Video motherboard, software drivers and utilities must be installed. The following are various driver installation procedures for Windows 95 under specific situations.

### Windows Plug and Play in Windows 95: (Auto installing drivers)

**IMPORTANT:** If an ASUS Video or Audio/Video device (or ATI compatible) was installed at one time, Windows 95 Plug and Play may install ATI's original driver upon entering Windows 95. The old driver may cause your system to hang. If this happens, follow these steps to reset your display driver to its basic defaults:

1. Enter Windows 95 in **safe mode** by pressing **F5** repeatedly during bootup
2. **Right click** the mouse on the open desktop (not over any icons)
3. Select **Properties**
4. Click the **Settings** tab - Settings menu appears
5. Click **Change Display Type** - Change Display Type windows appears.
6. Click **Change** button - Select Device windows appears.
7. Click **Show all devices** - Manufacturers and Models appears
8. Click **(Standard display types)** - Standard Display Adapter (VGA) is selected
9. Click **OK** button - Change Display Type windows appears.
10. Click **Apply** button - System Settings Change window appears
11. Click **Yes** button to restart your computer now - restart in normal mode.

# VI. Microsoft Windows 95

## Video Driver Installation

### Installing ATI Video drivers in Windows 95: (New Hardware Found)

If installing an ASUS Video or Audio/Video motherboard for the first time, a “New Hardware Found” window will appear upon entering Windows 95:

Select which driver you want to install for your new hardware:

- Windows default driver
- Driver from disk provided by hardware manufacturer
- Do not install a driver (Windows will not prompt you again)
- Select from a list of alternate drivers

1. Click **OK** to use the default selection: “Driver from disk provided by hardware manufacturer”
2. Insert ASUS installation CD and click **Browse** button - Open windows appears.
3. Select you CD-ROM drive in the “Drives:” box
4. Select **win95\english (\enhanced) (\japanese) - macxw4.inf** shows in “File name:”  
**NOTE:** Select the directory according to your Windows language. “Enhanced” produces slightly better performance but without Microsoft’s Windows certification.
5. Click the **OK** button - Install from Disk appears - Click OK button again.
6. Your ASUS audio/video motherboard should be auto detected, if not select the appropriate model of your Video or Audio/Video motherboard (click **Show all devices** if necessary) - Copying Files... appears - message appears to restart your computer.

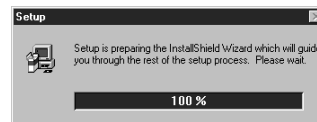
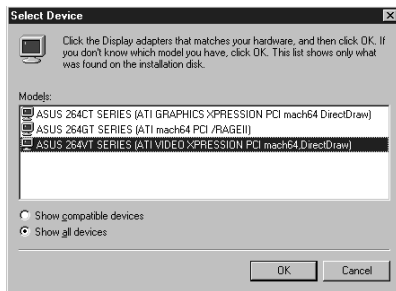

7. Click **Yes** button - ATI Desktop Help will appear upon restart, make changes as necessary.

# VI. Microsoft Windows 95

## Video Driver Installation

### Installing ATI Video drivers in Windows 95 (Prompted by Windows 95)

If an ASUS Video or Audio/Video motherboard (or ATI compatible) was installed unsuccessfully or modified at one time a “Display” message will appear upon entering Windows 95:

There is a problem with your display settings. The adapter type is incorrect, or the current settings do not work with your hardware.

1. Click **OK** button to continue - The “Settings” tab of the Display Properties appears.
2. Click **Change Display Type** - Change Display Type windows appears.
3. Click **Change** button - Select Device windows appears.
4. Click **Have Disk** button - “Install From Disk” window appears
5. Insert ASUS installation CD and Click **Browse** button - Open window appears
6. Select your **CD-ROM** drive in the “Drives:” box
7. Select win95\english (\enhanced) (\japanese) - **macxw4.inf** shows in “File name:”  
**NOTE:** Select the directory according to your Windows language. “Enhanced” produces slightly better performance without Microsoft’s Windows certification.
8. Click the **OK** button - Install from Disk appears - Click **OK** button again.
9. Click **Show all devices** (if available)
10. Select the appropriate model of your Video or Audio/Video motherboard - Copying Files... appears
11. Change your monitor type if necessary - Click **Close** button when finished.
12. Adjust the “Desktop area,” “Color palette,” and “Font size” if necessary - Click **Apply** button when finished - System Settings Change windows appears:

You must restart your computer before the new settings will take effect.  
Do you want to restart your computer now?

13. Click **Yes** button - ATI Desktop Help will appear upon restart, make changes as necessary.

# VI. Microsoft Windows 95

## Video Driver Installation

### Updating installation in Windows 95: (Using Autorun Screen)

If for some reason you need to reinstall the ATI video drivers or if you skipped the previous procedures, you may use the following steps:

1. Insert the ASUS installation CD (or double click on the CD drive in “My Computer” if CD already inserted)- ASUS Windows 95 Install Shell appears.

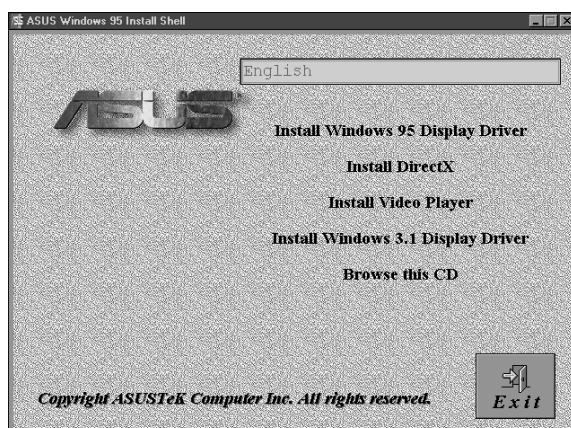

2. Click **Install Windows 95 Display Driver** - Display Properties and installation information appears.
3. Select the **Settings** tab and Continue from step 2 above.

# VI. Microsoft Windows 95

## Software MPEG & Video Player

Software MPEG allows the viewing of the following video files identified by their extensions:

- MPEG Format: (\*.MPG, \*.DAT, \*.MPV) Extensions
- AVI Files (\*.AVI) Extensions

For Software MPEG support in Windows 95, you must first install DirectVideo Upgrade For Microsoft Windows, then install ATI Video Player.

### Installing Microsoft DirectVideo in Windows 95:

1. Reinsert the ASUS installation CD or select the **CD** from My Computer.
2. Click **Install DirectX** - Click "Next" to install
3. Click **Done** button when finished.

### Installing ATI Video Player in Windows 95:

1. Reinsert the ASUS installation CD or select the **CD** from My Computer.
2. Click **Install Video Player** - ATI Setup: ATI VIDEO PLAYER window appears.
3. Click the **OK** button - Installation complete message will appear
4. Click **Restart Windows** button when finished

The setup program will give you "ATI Multimedia" in your Programs group and start button. The following icons will be available from the "Start" button once the driver has successfully been installed. Click ATI Player to bring up the ATI Player screen.

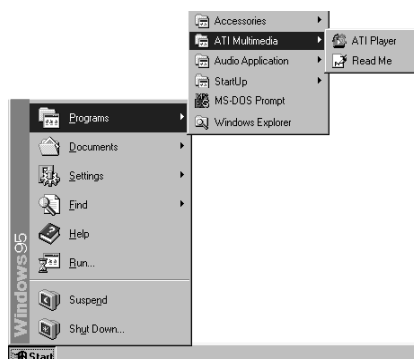

# VI. Microsoft Windows 95

## Windows 95 Display Settings

### Changing display settings:

To enter the “Display Properties” at any time, right click your mouse on the desktop and select “Properties” or double click the “Display” icon in the “Control Panel.” Click the appropriate Tab as follows:

### Adjustment



**Adjustment:** Click on the Position or Size arrows to make your screen appear as centered and large as possible.

### Panning



**Panning:** This allows you to assign hotkeys in the "Value" box to move your screen up, down, left, right, in, or out in any application. Click on "Defaults" button to fill in the "Value" box with default values.

### Color



**Color:** This allows you to adjust the Gamma level for your monitor and color levels for Red, Green, and Blue. You can save your settings by clicking "Save As" button and typing in a file name. This allows you to recall previously saved settings. Click on "Defaults" button to restore all settings to the default.



# VII. Microsoft Windows 3.x

## Video Driver Installation

For your convenience, the ATI video drivers for Windows 3.x can be installed in Windows 3.x or in DOS. The autorun ASUS Windows 3.1 Install Shell cannot be automatically run by Window 3.x, so manual execution is necessary.

### Installing ATI video drivers in Windows 3.x:

1. Start Windows 3.x
2. Run **File Manager**
3. Insert the ASUS installation CD.
4. Change to your CD drive.
5. Double click **setup.exe** - ASUS Windows 3.1 Install Shell appears

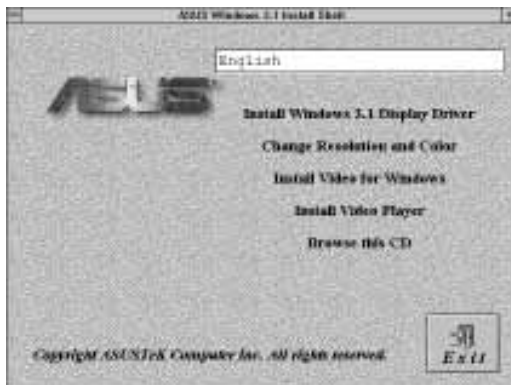

6. Click on **Install Windows 3.1 Display Driver**- Confirm Installation appears
7. Click **Yes** - Copying Files appears - Restart Windows appears
8. Click **Restart now** to complete installation - ATI Desktop group and icon will appear upon restart - Install Shell Message appears:

Now installation process will continue. If you want to install Video for Windows, please keep your ASUS driver CD in CD-ROM drive.

9. Click **OK** - Follow the instructions for Software MPEG & Video Player.

# VII. Microsoft Windows 3.x

## Video Driver Installation

### Installing ATI video drivers in DOS:

1. Enter DOS mode (Exit Windows, do not use Windows DOS prompt)
2. Change to your CD-ROM drive
3. Type: **W31INST**

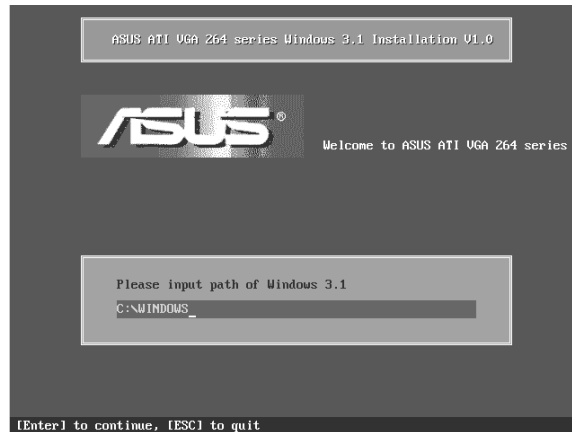

4. Press Enter to confirm path of Windows 3.x or change if necessary.
5. “ASUS driver is successfully installed !!” - **press any key**.
6. “Do you want to launch Windows 3.1 to continue installation now? (Y/N)”
7. Install Shell Message appears:

Now installation process will continue. If you want to install Video for Windows, please keep your ASUS driver CD in CD-ROM drive.

8. Click **OK** - Follow the instructions for Software MPEG & Video Player.

# VII. Microsoft Windows 3.x

## Software MPEG & Video Player

Software MPEG allows the viewing of the following video files identified by their extensions:

- MPEG Format: (\*.MPG, \*.DAT, \*.MPV) Extensions
- AVI Files (\*.AVI) Extensions

For Software MPEG support in Windows 3.x, you must first install Microsoft's Video for Windows, then install ATI Video Player.

### Installing Microsoft Video for Windows in Windows 3.x:

1. Click on **Install Video for Windows** - Video for Windows 1.1 Runtime appears
2. Click **Continue** - Setup appears - Setup Successful appears
3. Click **Restart now** to complete installation

### Installing ATI Video Player in Windows 3.x:

1. Run **File Manager**
2. Insert the ASUS installation CD.
3. Change to your CD drive.
4. Double click **setup.exe** - ASUS Windows 3.1 Install Shell appears

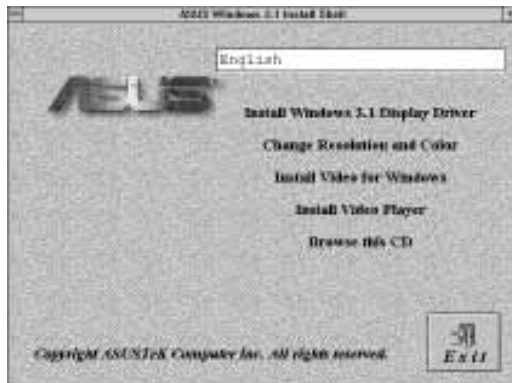

5. Click on **Install Video Player** - Memory Requirement appears:

The ATI Video Player needs at least 600K conventional memory to execute.  
If you are not sure or memory is not enough, you can type "**MEMMAKER**" under DOS to optimize your memory configuration.

6. Click **Continue** - ATI Setup: ATI VIDEO PLAYER appears with message
7. Click **OK** to start installation - Installation completed message appears.
8. Click **OK** to complete installation - Restart Windows? appears
9. Click **Restart Windows** button.
10. The Video Player icon will be added to the ATI Desktop menu.

## VII. Microsoft Windows 3.x

**NOTE:** This section shows screens for Windows 3.1x although feature descriptions may be used for both Windows 3.1x and Windows 95.

### ATI Desktop Control Panel

An ATI DeskTop is installed automatically when you install the enhanced driver for Windows. Double click on the icon to display the ATI Desktop Control Panel.

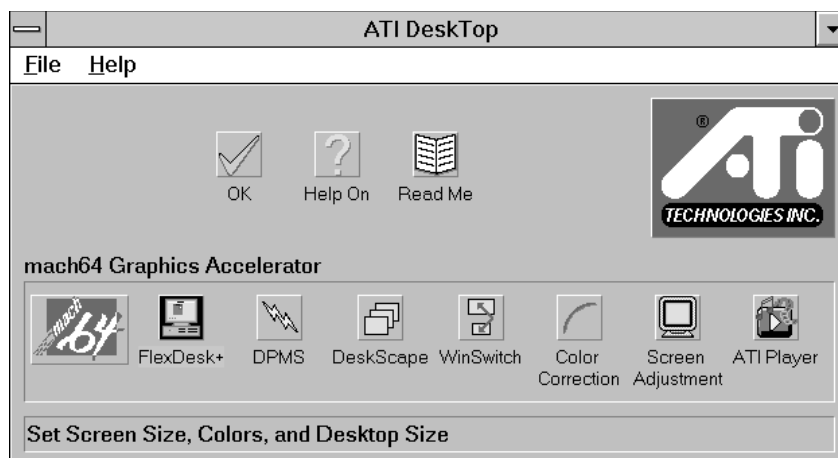

The **ATI DeskTop** provides a consistent and integrated control. Depending on what has been installed, your DeskTop may not have the same number of features as shown above.

Each feature icon in the *Mach64* product group shown in this DeskTop is described on the following pages.

### ATI Desktop Features

**Help On:** Click this icon, then click any other icon in the product group to display Help information on the selected item.

**Read Me:** Click this icon then click the Mach64 logo or feature icon to display the readme file on the item.

**ATI Logo:** Double click this logo to generate a problem report which includes pertinent data on your system and device configuration to help solve your problem. Have the report ready before contacting your vendor.

**Feature Icons:** Double click a Feature icon to launch the associated control panel.

# VII. Microsoft Windows 3.x

## FlexDesk+



### FlexDesk+ Basic Settings

**FlexDesk+** is for configuring the operating modes and parameters of the ASUS ATI VGA. The availability of options in FlexDesk+ is dependent on the device and its hardware configuration. This control panel allows you to configure Colors (color depth), Screen Size (resolution), Desktop Size (virtual desktop size), Advanced settings and Default parameters (factory settings). A Status Bar at the bottom of the panel displays help information as you make your selection.

**FlexDesk+** Provides **dynamic screen information feedback** as you adjust the sliders for "Colors", "Screen Size" and "Desktop Size." Any setting not supported by the device is shown in gray. A slider will always snap to the nearest supported setting for the current slider combination.

The **Sample Color Bar** next to the Sample Monitor dynamically shows a color palette that approximates the Colors setting as you adjust the Colors slider.

**NOTE:** If your desired resolution is not available, check your monitor configuration setting in the INSTALL program.

#### Sliders

**Colors:** Select color depths of 256; 32,000; 65,000; or 16.7million colors.

**Screen Size:** Selects standard screen resolutions of 640x480, 800x600, 1024x768, 1152x864, and 1280x1024.

**Desktop Size:** Selects virtual desktop sizes of 640x480, 800x600, 1024x768, 1152x864, 1280x1024, and 1600x1200. Desktop size is greater than or equal to Screen size. The virtual desktop provides expanded work space on your screen even if your monitor cannot display that resolution by allowing you to pan past your visible screen.

## VII. Microsoft Windows 3.x

---

### **Buttons**

**Test:** Automatically switches on monitor to display the selected mode without exiting this control panel, for 10 seconds or until the user clicks the End Test, OK, or Cancel button. All other buttons and sliders are inactive at this time. To show dynamic color depth changes in this test, the WinSwitch feature must be enabled before starting the current session of Windows.

**Defaults:** Returns Screen Size, Colors, and Desktop Size sliders to the default positions. When OK is clicked, these changes will be effective.

**Advanced...:** Opens the Advanced panel. See FlexDesk+ Advanced Settings.

**Help:** Displays Help information on FlexDesk+.

**OK:** Exits the FlexDesk+ control panel and effects all new changes.

**Cancel:** Discards all changes and exits the FlexDesk+ control panel.

### **FILE Menu**

**Open:** Opens an existing Setting file.

**Save:** Saves the current settings to the active Setting file.

**Save As:** Saves the current settings to an alternate Setting file which you can name.

**Exit:** Exits the FlexDesk+ control panel.

### **FEATURES Menu**

**Defaults:** Provides same functionality as the push button.

**Advanced...:** Provides same functionality as the push button.

### **HELP Menu**

**Help:** Provides same functionality as the push button.

**Contents:** Displays the Help index.

**About...:** Displays the product version number and information.

# VII. Microsoft Windows 3.x

## FlexDesk+ Advanced Settings

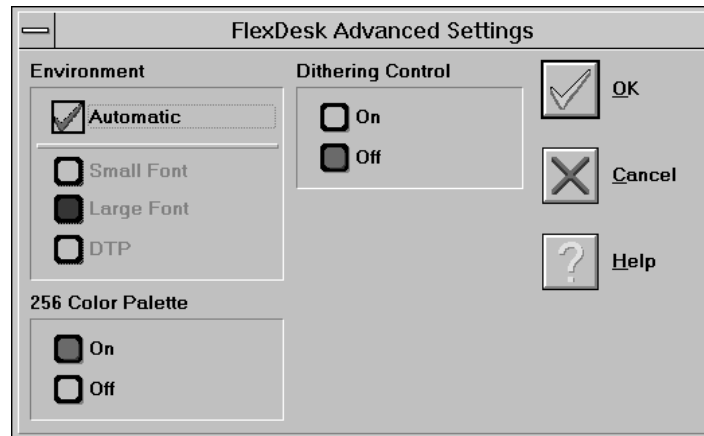

### Environment

This parameter specifies logical dots per inch (LDPI). Being logical, i.e., not physical dots, the effect will differ depending on screen size. Automatic Mode chooses the optimal environment setting for the selected screen size. The Small, Large and DTP settings are 96, 120, and 128 LDPI respectively.

### 256 Color Palette

This selection is only available in 256 color mode. **Windows runs faster when this option is turned off.**

**On:** Allows the application to define color selection in the palette.

**Off:** Choose colors from a fixed palette.

### Dithering Control

Dithering is meshing two colors to produce the illusion of a third. This selection is only available in 256 color mode with 256 Color Palette on.

**On:** Provides standard VGA dithering of colors and color selection boxes.

**Off:** Provides smooth dithering which results in faster performance than VGA dithering.

### Buttons

**OK:** Accepts the advanced settings as shown and returns to the FlexDesk+ main panel.

**Cancel:** Discards all changes and returns to the FlexDesk+ main panel.

**Help:** Displays Help information on FlexDesk+.

## VII. Microsoft Windows 3.x

### DPMS (for Windows)

Win3.1 Limitation: In some newer BIOS, DPMS function doesn't work normally.

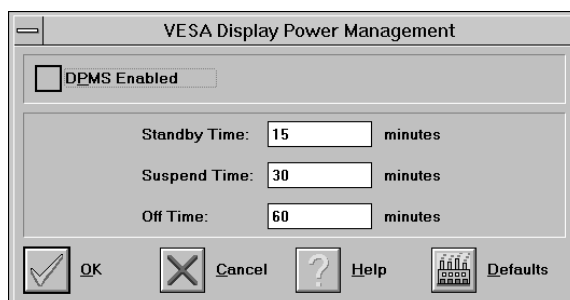

VESA DPMS-compliant monitors conserve electrical energy by powering down after a period of inactivity. You can use the DPMS panel (in Windows) to configure the auto-shutdown timing sequence for your DPMS-compliant monitor. (The DOS version of DPMS is described in another section.)

**WARNING: Monitors that do not support VESA DPMS can be damaged by activation of the DPMS feature.**

**Do not use screen saver when DPMS is enabled. The screen saver will conflict with the DPMS operation.**

#### Enable DPMS for Windows:

1. Click the DPMS icon.
2. Highlight the timer boxes one at a time and specify the values.
3. Turn on DPMS Enabled.
4. Click OK.

#### Timer Settings

**Standby Time:** Time value is in minutes, after which Standby mode is activated if no user activity is detected. Standby is the first level of power conservation.

**Suspend Time:** Time value is in minutes, after which Suspend mode is activated if no user activity is detected. The monitor conserves more energy at this level than at Standby.

#### Off Time

Time value is in minutes, after which Off mode is activated if no service activity is detected. At this level, energy conservation is the highest.

#### Buttons

**DPMS Enable:** DPMS feature is enabled if box is checked.

**Defaults:** Sets DPMS timers to default values.

**Help:** Displays Help information on DPMS.

**OK:** Accepts settings as shown and exits.

**Cancel:** Discards all changes and exits.



## VII. Microsoft Windows 3.x

### DeskScape

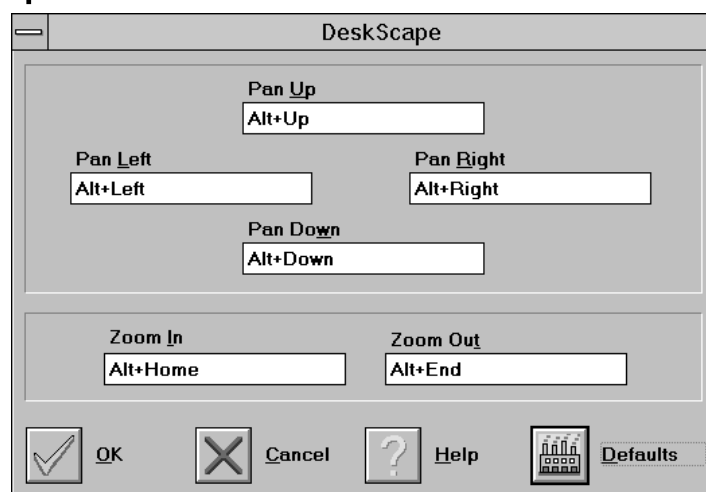

**NOTE:** Press **Default** to fill in the fields with default keys first.

**DeskScape** allows more control over your Virtual Desktop using keyboard keys. For a description of Screen and Desktop, Refer to the *Using FlexDesk+* section.

The displayed image on the screen is a "window" showing only a portion of the entire virtual desktop. The non-displayed portion can be brought into view by panning. Four keys are assigned to this function, one for each direction of up, down, left and right. If you are using a mouse, the window may be panned by moving the mouse cursor to any edge of the window as well.

Zoom In will display a larger image but less of the desktop; Zoom Out has the opposite effect. What you can zoom is dependent on the relative settings of Screen Size and Desktop Size.

Use this panel to assign the six hot keys to Panning and Zooming functions. Alpha-numeric keys may be assigned in any combination with <ALT>, <Ctrl> and <Shift>. We recommend that you assign all the keys in one session.

### DeskScape Functions

**Pan Up:** Moves the "window" upward, with user defined keys, e.g.: **Alt** ↑

**Pan Left:** Moves the "window" to the left, with user defined keys, e.g.: **Alt** ←

**Pan Right:** Moves the "window" to the right, with user defined keys, e.g.: **Alt** →

**Pan Down:** Moves the "window" downward, with user defined keys, e.g.: **Alt** ↓

**Zoom In:** Makes the screen image larger, with user defined keys, e.g.: **Alt Home**. **NOTE:** The entire desktop can be panned.

**Zoom Out:** Displays more of the virtual desktop, with user defined keys, e.g.: **Alt End**

# VII. Microsoft Windows 3.x

## Buttons

**Defaults:** Assigns default keys to DeskScan.

**Help:** Displays Help information on DeskScan.

**OK:** Accepts key assignments as shown and exits.

**Cancel:** Discards all changes and exits.

## WinSwitch

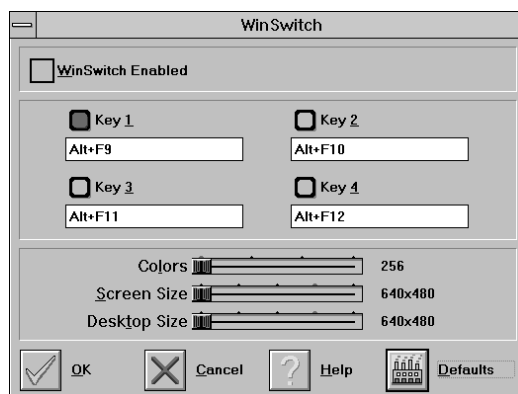

**NOTE:** Press **Default** to fill in the fields with default keys first.

By pressing a user-defined set of keyboard keys **WinSwitch** can dynamically change screen attributes (i.e., Colors, Screen Size and Desktop Size) without exiting Windows.

When enabled, WinSwitch is actually operating in 24bpp mode-i.e., all other color depths and resolutions are emulations. As such, graphics performance across various color depths will be practically identical to that of 24bpp (16.7 million colors). Therefore, WinSwitch should be used only when color depth changes are desired. For maximum performance in 256 or 65,000 color modes, you should disable WinSwitch. **FlexDesk+** or **DeskScan** can provide the same dynamic screen size or desktop size switching functions.

### Configuring the WinSwitch Panel

At the top of the panel is a checkbox labelled WinSwitch Enabled. This switch must be turned on (checked) to enable WinSwitch, which is primarily a dynamic color switching function. Clicking one of the four radio buttons (e.g., key 1) will display the slider positions currently associated with that key.

#### Procedure:

1. Select a radio button. Define the key combination in the field below it. You must include **<Ctrl>** or **<Alt>**.
2. Adjust any or all of the sliders. Slider functions are identical to those in FlexDesk+.
3. Either enable WinSwitch by checking the WinSwitch Enabled box, or disable WinSwitch by removing the check mark.
4. Click Ok.

# VII. Microsoft Windows 3.x

## Buttons

**Key 1:** First of four radio buttons labeled key 1, key 2, key 3, and key 4. The slider settings shown are associated with the selected radio button.

**Defaults:** Restores key combination and slider settings to defaults.

**Help:** Displays Help information on WinSwitch.

**OK:** Accepts current settings and exits.

**Cancel:** Discards all changes and exits.

**WinSwitch:** Switching function is enabled when the box is Checked; disabled when the box is empty.

## Key Combination Fields

**Key 1 Field:** Keyboard key combinations to be used to activate WinSwitch are specified in the four key combination fields, associated with Keys 1-4.

**Sliders - These sliders provide the same functions as the FlexDesk+ sliders.**

**Colors:** Selects a color depth from one of the supported Colors.

**Screen Size:** Sets the screen resolution to one of the supported sizes.

**Desktop Size:** Sets the virtual desktop to one of the supported sizes.

## Screen Adjustment

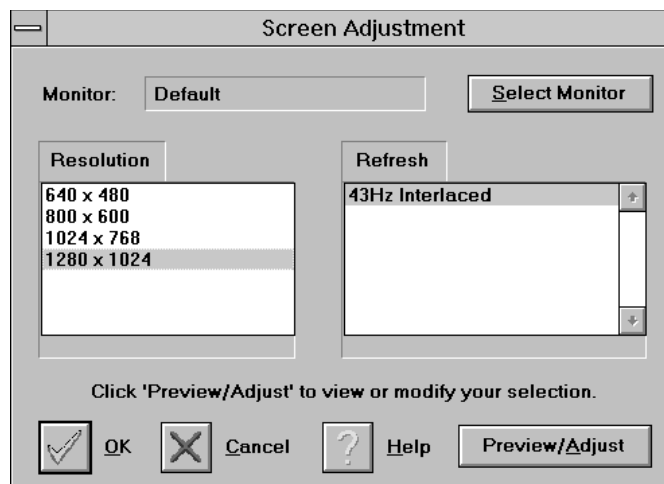

This allows the selection of different resolutions supported by your monitor. Select the proper monitor by pressing the "Select Monitor" button and then choosing from the list of monitors.

## VII. Microsoft Windows 3.x

---

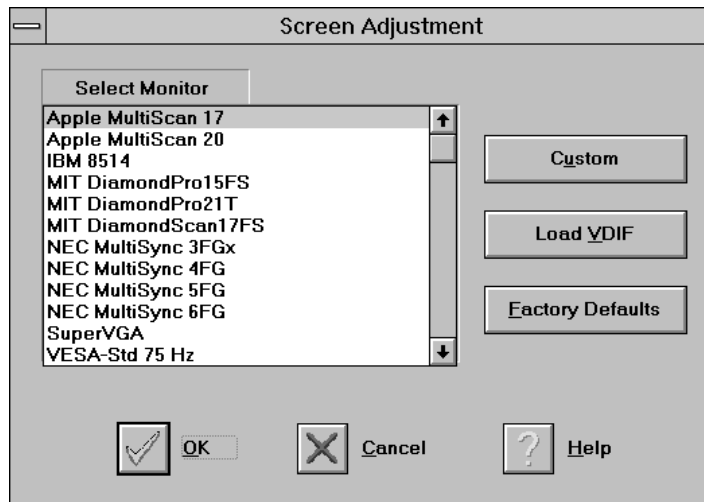

If your monitor came with a VDIF file then you may insert it into your floppy drive and press the "Load VDIF" button. The "Custom" button allows you to select the resolution and refresh rates. You may try out different settings that will optimize your display preferences but too high of a refresh rate will push your monitor past its specifications. Use the Preview/Adjust to see the results and allow digital adjustments to the screen. If the image is distorted you may press <Esc> or wait a few seconds to return to the original menu without the change.

## VII. Microsoft Windows 3.x

---

The ASUS ATI VGA supports a VESA power management control specification called **DPMS**-Display Power Management Signaling. Monitors that comply with DPMS can provide energy savings up to 80% compared to non DPMS compliant monitors. This also translates into extended monitor life.

DPMS control functions are provided for DOS and Windows operations. This chapter describes the DOS version, a Terminate-and-Stay-Resident program. TSR means it runs in the background once activated. The Windows version provides control via a Windows type control panel in the ATI DeskTop.

### NOTES:

- Monitors that do not support VESA DPMS can be damaged by activation of the DPMS feature. Check your monitor specifications.
- Do not use screen saver when DPMS is enabled. The screen saver will conflict with DPMS operation.

### DPMS (for DOS)

When you run DPMS for the first time, without parameters, DPMS will set the Standby, Suspend, and Off timers to default values. If DPMS has been loaded, running it again without parameters will display the current timer values, as follows:

<b>Standby timer:</b>	<b>15 minutes</b>
<b>Suspend timer:</b>	<b>30 minutes</b>
<b>off timer:</b>	<b>60 minutes</b>

If you run DPMS with at least one timer parameter, DPMS will set that value and disable the unspecified timers.

DPMS parameters are to be included in the command separated by spaces, as follows:

**DPMS** parameter <Enter>

**Example:** To set the Standby timer to 5 minutes, and disable the Suspend and Off timers: **DPMS STBY 5** <Enter>

### DPMS Parameters

**stby x** - Places the monitor into Standby mode after x minutes and seconds. For example, x for two minutes and ten seconds is specified as 2:10. Standby is the first level of power conservation. The monitor is instantly ready if activity is detected.

**susp x** - Places the monitor into Suspend mode after x minutes and seconds. The monitor conserves more energy at this level than at Standby.

**off x** - Places the monitor into Off mode after x minutes and seconds. The monitor is at the highest level of energy conservation.

**nomouse** - Does not detect mouse activity.

**quiet** - Suppresses DPMS messages.

**unload** - Un-installs DPMS from system memory.

**help** - Displays help messages.

# VIII. Windows Video Player

## ATI Player and control panel (Win3.1x and Win95)

If MPEG drivers are installed, for playing video clips, the ATI Player icon will appear in the DeskTop. Double click on this icon to bring up the Video Screen as shown here: (Detailed button definitions are shown when holding the cursor over the individual buttons for a few seconds.)

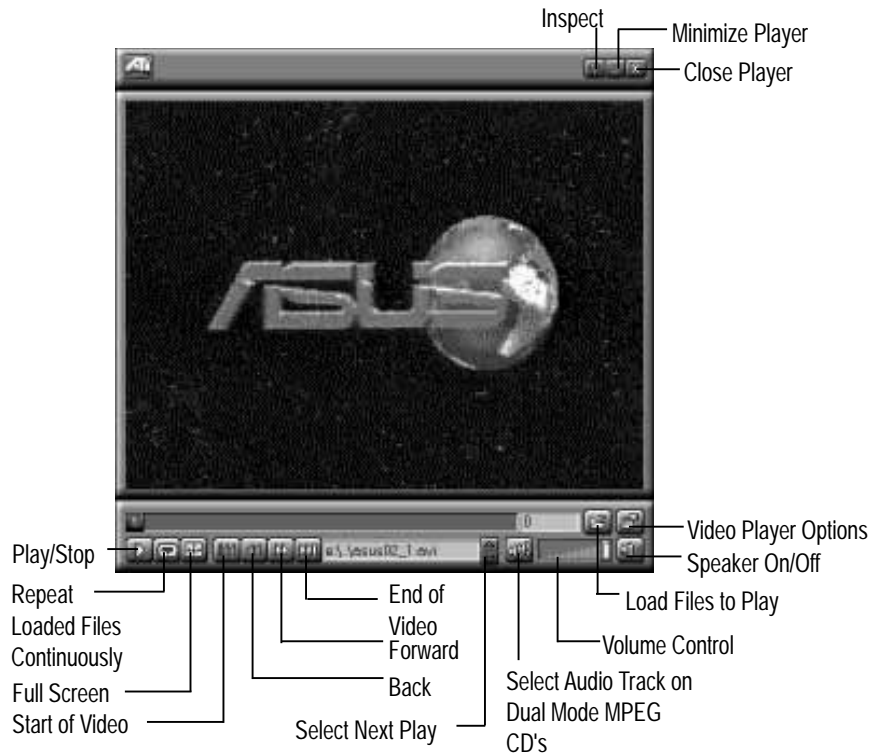

**NOTE:** The video shown is an example only and not provided in the CD.

## Features

The question mark on top right of the Video Screen allows inspection into each button on the control panel. Click on the "?" then on a button that you would like to know about.

### ATI Player Setup



### MPEG

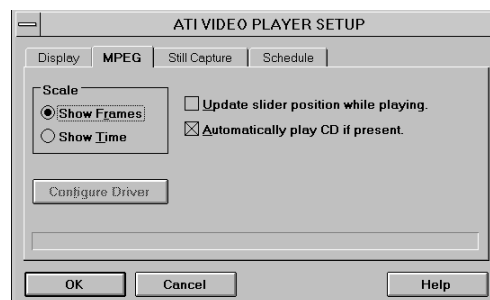

# VIII. Windows Video Player

## Still Capture



## Schedule



Select Files To Play (Windows 3.1x and Windows 95)

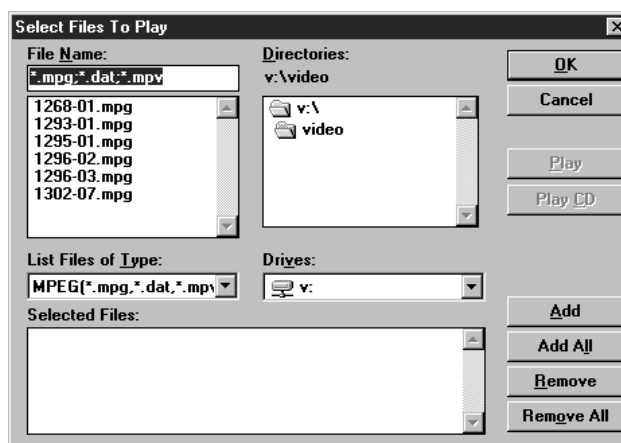

For MPEG CD's, select the proper drive of the CD ROM and click on the 'Play CD' button. For MPEG files, select the files and click the "Add" button to add to the play list then click on the "Play" button.

**NOTE:** The above data is only an example and is not included in the software bundle.

## Video Acceleration Performance

Video is very data-intensive. For this reason, there are a number of factors which will negatively impact playback performance, including the type of compression used. *RLE* and *Video 1* are manageable with most 386 or higher systems; *Indeo* supports additional color depth, and is best run on faster 486 (or Pentium) systems.

## Playing Video Clips

Use the Microsoft Windows Media Player to play or insert video clips (i.e., files with the .AVI filename extension) into various documents. For details please refer to the Media Player on-line Help and the *Microsoft Windows 3.1 User's Guide*.

## Sizing Windows

The video clip window can be sized using <Ctrl> and number keys 1 & 2, providing 1x and 2x zoom respectively.

# IX. Microsoft Windows NT

---

## Video Driver Installation

### Windows Plug and Play in Windows NT 4.0: (Auto installing drivers)

**IMPORTANT:** If an ASUS Video or Audio/Video motherboard (or ATI compatible) was installed at one time, Windows NT 4.0 Plug and Play may install ATI's original driver upon entering Windows NT 4.0 . The old driver may cause your system to hang. If this happens, follow these steps to reset your display driver to its basic defaults:

1. Enter Windows NT 4.0 in **safe mode** by pressing **F5** repeatedly during bootup
2. **Right click** the mouse on the open desktop (not over any icons)
3. Select **Properties**
4. Click the **Settings** tab - Settings menu appears
5. Click **Change Display Type** - Change Display Type windows appears.
6. Click **Change** button - Select Device windows appears.
7. Click **Show all devices** - Manufacturers and Models appears
8. Click **(Standard display types)** - Standard Display Adapter (VGA) is selected
9. Click **OK** button - Change Display Type windows appears.
10. Click **Apply** button - System Settings Change window appears
11. Click **Yes** button to restart your computer now - restart in normal mode

**NOTE: Video for Windows, Direct Video, & Video Player is not available for any versions of Windows NT.**



# IX. Microsoft Windows NT

## Video Driver Installation

### Installing ATI Video drivers in Windows NT 4.0: (New Hardware Found)

If installing an ASUS Video or Audio/Video motherboard for the first time, a “New Hardware Found” window will appear upon entering Windows NT 4.0:

Select which driver you want to install for your new hardware:

- Windows default driver
- Driver from disk provided by hardware manufacturer
- Do not install a driver (Windows will not prompt you again)
- Select from a list of alternate drivers

1. Click **OK** to use the default selection: “Driver from disk provided by hardware manufacturer”
2. Insert ASUS installation CD and click **Browse** button - Open windows appears.
3. Select you CD-ROM drive in the “Drives:” box
4. Select `\nt40 - ati.inf` shows in “File name:”

**NOTE:** Select the directory according to your Windows language. “Enhanced” produces slightly better performance but without Microsoft’s Windows certification.

5. Click the **OK** button - Install from Disk appears - Click OK button again.
6. Your ASUS audio/video motherboard should be auto detected, if not select the appropriate model of your Video or Audio/Video motherboard (click **Show all devices** if necessary) - Copying Files... appears - message appears to restart your computer.

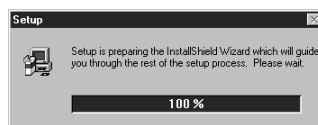

7. Click **Yes** button - ATI Desktop Help will appear upon restart, make changes as necessary.

**NOTE: Video for Windows, Direct Video, & Video Player is not available for any versions of Windows NT.**

# IX. Microsoft Windows NT

## Video Driver Installation

### Installing ATI Video drivers in Windows NT 4.0 (Prompted by Windows NT)

If an ASUS Video or Audio/Video motherboard (or compatible) was installed at one time a "Display" message will appear upon entering Windows NT 4.0 :

There is a problem with your display settings. The adapter type is incorrect, or the current settings do not work with your hardware.

1. Click **OK** button to continue - The "Settings" tab of the Display Properties appears.
2. Click **Display Type** - Change Display Type windows appears.
3. Click **Change** button - Select Device windows appears.
4. Click **Have Disk** button - "Install From Disk" window appears
5. Insert ASUS installation CD and Click **Browse** button - Open window appears
6. Select your **CD-ROM** drive in the "Drives:" box
7. Select \nt40 - **ati.inf** shows in "File name:"
8. Click the **OK** button - Install from Disk appears - Click **OK** button again.
9. Click **Show all devices** (if available)
10. Select the appropriate model of your Video or Audio/Video Motherboard - messages appears: "You are about to install a third-party driver..."
11. Click **Yes** - Copying Files... appears - message appears: "The drivers were successfully installed"
12. Click **OK** button
13. Change your monitor type if necessary - Click **Close** button when finished.
14. Adjust the "Desktop area," "Color palette," and "Font size" if necessary - Click **Apply** button when finished - System Settings Change windows appears:

You must restart your computer before the new settings will take effect.  
Do you want to restart your computer now?

15. Click **Yes** button - ATI Desktop Help will appear upon restart, make changes as necessary.

### Updating installation in Windows NT 4.0: (Using Autorun Screen)

If for some reason you need to reinstall the ATI video drivers or if you skipped the previous procedures, you may use the following steps:

1. Insert the ASUS installation CD (or double click on the CD drive in "My Computer" if CD already inserted)- ASUS Windows NT Install Shell appears.
2. Click **Install Windows NT Display Driver** - Display Properties and installation information appears.
3. Select the **Settings** tab and Continue from step 2 above.

**NOTE: Video for Windows, Direct Video, & Video Player is not available for any versions of Windows NT.**

# IX. Microsoft Windows NT

---

## Video Driver Installation

The mach64 driver for Windows NT is shipped with Windows NT. Before installing the mach64 driver, you must have installed Windows NT and selected VGA display.

### Installing ATI video drivers in Windows NT 3.5, 3.51:

1. Boot Windows NT
2. Double-click the **Main** icon.
3. Double-click the **Control Panel** icon.
4. Double-click the **Display** icon.
5. Click **Change Display Type** button.
6. Click **Change** button.
7. Insert the installation CD into the CD-ROM drive.
8. Click **Other** button.
9. Supply the Setup program with the location of the NT files of your revision, for example, type: **D:\NT35 (\NT351)**
10. Click **OK** button.
11. Select the appropriate driver for your ASUS audio/video motherboard
12. Click **Install** button.
13. Click **Yes** to change to your system configuration.
14. Click **Continue** to confirm the full path name.
15. If you are upgrading your driver, you will be asked whether you want to use the “Current” or “New” driver. Select **New** driver to install the drivers.
16. After the files have been copied to your computer, click **OK**
17. **Reboot** Windows NT
18. After reboot the Invalid Display Settings window appears - Click **OK**
19. The Display Settings dialogue box appears - Select a desired display mode. For more detailed information about changing your display mode, click Help.

**NOTE: Video for Windows, Direct Video, & Video Player is not available for any versions of Windows NT.**

# X. IBM OS/2 & OS/2 Warp

## Video Driver Installation

The ATI OS/2 video driver is to be used for the English version of OS/2 only.

Installing ATI video drivers in English OS/2 or OS/2 Warp:

1. Start OS/2
2. Check that OS/2 is using standard VGA driver and other applications are closed.
3. Double-click the **OS/2 System** folder.
4. Double-click the **Command Prompts** folder.
5. Double-click the **OS/2 Full Screen** object.
6. Insert the installation CD (assuming your CD-ROM drive is letter D)
7. Type **D:** <Enter>, **CD OS2** <Enter>, **OS2INST** <Enter>



8. Select **IBM OS/2** - Install OS/2 Driver appears.
9. Select your version of OS/2.
10. Type **C:** (the drive letter of your OS/2 system) <Enter> - copying files appears.
11. Exit the installation program
12. Type **C:** <Enter>, **CD\MACH\_OS2** <Enter>, **DSPINSTL**
13. Display Driver Install panel appears - select Primary Display.
14. Click **OK** - Driver selection list appears.
15. Select the latest ATI mach64 enhanced driver version from the list - click **OK**.
16. In the Monitor Configuration Selection Utility, select **Install Using Defaults for Monitor Type**, then click **OK**.
17. When the source directory panel appears, choose **Change** and enter path or use the default location of **C:\MACH\_OS2** - Click **SET**
18. Click **INSTALL**.
19. Type **EXIT** to close the OS/2 full screen command prompt.
20. **Shut down** OS/2
21. **Restart** OS/2. It will default to 640x480 in 256 colors. To change screen resolution and/or color depth, see your OS/2 User's Guide.

# XI. Other Video Drivers

## AutoCAD Video Driver Installation

### Installing ATI AutoCAD Video Drivers:

1. Enter DOS mode (Exit Windows, do not use Windows DOS prompt)
2. Insert the installation CD (assuming your CD-ROM drive is letter D)
3. Type **D:** <Enter>, **CD DOS\ENGLISH (DOS\JAPANESE)** <Enter>, **INSTALL** <Enter>



4. Select **Drivers Installation** and press <Enter>
5. Select the Application name **AutoCAD** <Enter>



6. Follow the instructions to complete the installation of the drivers.
7. Press **Enter** when completed and press **ESC** twice and **Y** to exit the installation program.
8. Reboot the computer from DOS - Your Windows 3.x & DOS system ATI drivers should be installed and ready to use.

# XI. Other Video Drivers

## Microstation Video Driver Installation

### Installing ATI Microstation Video Drivers:

1. Enter DOS mode (Exit Windows, do not use Windows DOS prompt)
2. Insert the CD (assuming your CD-ROM drive is letter D)
3. Type **D:** <Enter>, **CD DOS\ENGLISH (DOS\JAPANESE)** <Enter>, **INSTALL** <Enter>



4. Select **Drivers Installation** and press <Enter>
5. Select the Application name **Microstation** <Enter>



6. Follow the instructions to complete the installation of the drivers.
7. Press **Enter** when completed and press **ESC** twice and **Y** to exit the installation program.
8. Reboot the computer from DOS - Your Windows 3.x & DOS system ATI drivers should be installed and ready to use.

# XI. Other Video Drivers

## Select System Information (optional)

The program will check the system for possible conflicts with the device, and display both the device and system configurations in the INFO BOX. In case of a conflict, it will issue a warning and suggest possible corrective actions.

Your ASUS audio/video motherboard is a PCI Plug-and-Play compatible: your system will automatically allocate system resources and resolve possible conflicts between your Plug-and-Play compatible mach64 accelerator device and other expansion cards.

### System Information

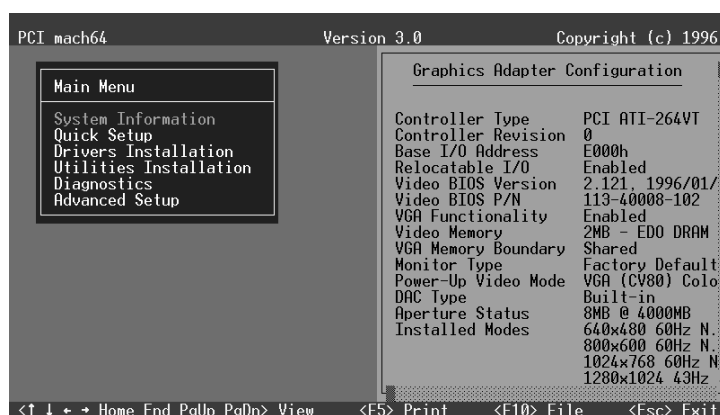

## Quick Setup (optional)

Select Quick Setup to configure the accelerator device to work with your monitor. As you highlight each monitor, the display specifications for that monitor type are listed in the INFO BOX. Proper monitor selection is necessary for correct resolution and refresh rate operation. You have four options to choose a correct Monitor Type.

**Selecting Your Monitor Type:** Factory Default/Apple.../IBM.../MIT.../NEC.../VESA-Std.../Generic.../Read VDIF.../Custom...

**Select Read VDIF...** If you have a VDIF file for your monitor and wish to use its parameters to automatically configure the mach64. Additional VDIF details are provided later in this chapter, in the section: *VDIF Files*

**Select Custom...** if none of the above applies to you, or you wish to manually configure the settings. Please refer to the information provided later in this chapter in the section: **Custom Configuration**

### Notes On Refresh Rates:

- A higher refresh rate reduces screen flicker, and therefore reduces eye strain. Not all refresh rates are supported at all color depths. Refer to the features section for specifications of your ASUS audio/video motherboard.
- The resolution used by your software application is independent of the refresh rate. Resolution depends on the installed software driver and selected display mode.

# XI. Other Video Drivers

## VDIF Files (optional)

VDIF files are VESA Display Information Format files. They contain all the necessary configuration parameters for getting optimal resolution and refresh rate operation from the specified monitor. Consult your monitor manufacturer for availability of VDIF files.

If you have a VDIF file for your monitor, select it. The INSTALL program will read the VDIF file and automatically configure the device to properly work with your monitor.

### Procedure:

1. Start the INSTALL program.
2. Select Quick Setup and press <Enter>.
3. Insert into a floppy drive the disk containing the VDIF file.
4. Select READ VDIF... and press <Enter>.
5. Type in the location of the VDIF file (typically A: or B:). INSTALL will read the file and configure the device to support your monitor according to the VDIF specification.

## Custom Configuration

If your monitor is not listed in the Monitor Selection Menu, or you are not using DDC or VDIF, you can set up display modes, i.e., resolutions and refresh rates, on the device using the Custom... option. This option is useful even if you had selected a monitor from the list. For example, you can modify the screen centering or refresh rate on one resolution, and not change the other resolutions.

### Procedure:

1. Start the INSTALL program.
2. Select Quick Setup and press <Enter>.
3. Select Custom... and press <Enter>.
4. Pick a resolution, then a refresh rate. You will see a box outline.

**WARNING: Using the wrong refresh rate may permanently damage your monitor. For more information, please refer to the manual.**

**NOTE:** An incorrect Monitor Type setting may damage your monitor. Review your monitor specifications before making a selection from the Monitor Selection Menu. Do not exceed the monitor specifications. Using a refresh rate (i.e., vertical frequency) that is higher than specified may damage your monitor. The manufacturer will not be liable for any damage caused by incorrect settings. Consult your monitor manual to determine the highest refresh rate for each resolution that your monitor supports. A scrambled screen indicates your monitor is not capable of the selected display mode. In which case, you should immediately press <Esc> to exit.

**TIP:** If the monitor produces a scrambled display, try a lower refresh rate. If it is already at the lowest refresh rate, set that resolution to Not Supported.”

5. Adjust the size and position of the box outline. Press <Enter> to accept.
6. Repeat steps 2 and 3 until you are satisfied with the box outline for all the resolutions. When finished, remember to exit and save the settings.



# XI. Other Video Drivers

---

## Advanced Setup (optional)

If you wish to fine tune its settings for your monitor and system type, select Advanced Setup from the Main Menu. On-screen context sensitive help is displayed as you highlight each Advanced Menu item.

**WARNING:** The Advanced Configuration option allows you to use certain features that may add additional performance to your device. However these options may not be compatible with your system. If problems appear after an advanced option is changed, returning the device to factory defaults will rectify the situation.

### Factory Defaults

The device can be reset to factory defaults by pressing <Shift>+<F7>.

### Saving Your Configuration

Once you have finished configuring the necessary parameters described above, save them by pressing <F10>.

---

(This page was intentionally left blank)

# A. Troubleshooting

---

## Diagnostics

All installed graphics modes in the mach64 accelerator can be viewed and tested, by running the INSTALL program from the DOS prompt, or by running a diagnostics program called M64DIAG.EXE. Do not run it in a windowed or full-screen DOS box.

In the INSTALL program, select Test Graphics Adapter from the Diagnostics... option of the Main Menu. The Test Graphics Adapter menu has the following options:

- VGA Tests ...
- Accelerator Tests ...

Any time you suspect there is a problem, especially during installation, run the above tests. The information provided in this appendix will enable you to solve most problems.

## Troubleshooting

Because a typical computer system consists of many different parts, difficulties may arise from a combination of items, from software or hardware installation, to monitor compatibility. Listed below are several checks you can make to help determine what the problem is.

## System Lockup

- If you are using a memory manager such as QEMM or 386MAX you need to modify the command line in the CONFIG.SYS file so that the address of the graphics device video BIOS, C000 - C7FF, is excluded. For example, add "EXCLUDE = C000 - C7FF" to the command line.
- Remove all unnecessary boards.
- Disable shadow RAM.
- Ensure that the board is seated correctly and that the device has been installed using the proper utilities.
- Try the device in a different system and reset to factory defaults using the INSTALL program. If the device works in another system, the problem is likely due to incorrect configuration.

# A. Troubleshooting

---

## **Test Patterns OK; Applications Do Not Sync**

The wrong monitor type has been selected. Change the settings in the INSTALL program.

## **Windows Driver Not Installing Properly**

Windows must be running in 386 Enhanced Mode. Incompatible memory managers may prevent Windows from starting in enhanced mode. If this occurs, remove the offending driver or memory manager.

## **Windows NT 4.0 driver cannot pass "Test VGA."**

Please bypass "Test VGA" then load ATI drivers after completing installation.

## **AutoCAD Driver Not Installing Properly**

If using a 386, ensure that AutoCAD has been configured for the appropriate ADI driver. The protected mode driver requires extended memory.

## **Error Codes and Messages**

Problems and solutions for some common errors found by the test program are provided for your reference as follows:

### **Memory aperture test failure or Diagnostics program locks or Reboots during aperture test**

If you receive an error message indicating that the memory aperture location is conflicting with your system memory, restart the INSTALL program as follows: INSTALL APMAP <Enter>. Now when you enable Memory Aperture, you must select a location above but not overlapping System Memory (S), BIOS (B) or Reserved (R) locations. Not applicable for ISA cards.

### **Desired resolution is disabled and displayed in gray**

A mode displayed in gray means that the BIOS is told this mode is not available, based on the device configuration. Reinstall using custom monitor selection.

### **Menu item is disabled and displayed in gray**

The test program has determined that the mode or test is not available under the current configuration. Aperture tests are not available if the aperture is disabled, and CRT mode and pixel depth are determined by current installation, DAC type, memory size, and memory type.

### **Adapter not detected**

This message should only occur when a mach64 ASIC is not detected. If this message occurs and a mach64 board is present, it may indicate an I/O conflict, conflicts between the Extended Memory Manager (EMM) and the video ROM. Try removing all other boards from the system and booting from a plain DOS disk. Try excluding the video BIOS address (C0000-C7FFF) from the memory manager. Refer to the documentation furnished with the memory manager software for information.

# A. Troubleshooting

---

## **Any FIFO test error**

The effects of a bad command FIFO should be visible. (e.g., the screen does not come up, or it displays garbage.)

## **Quick memory test error**

Run Detailed RAM Test to confirm the error and identify the address of the error.

## **Detailed memory test error.**

Run Detailed RAM Test several times to confirm the error and take notes of any messages and error codes.

## **DAC LUT test failure.**

An error has occurred while testing the DAC LookUp Table. The problem should be visible on the top color bar of any 8bpp mode.

## **ROM checksum error.**

An error has been detected in the ROM.

## **Draw sequence failure.**

An error has occurred in the draw engine. If the error is intermittent, it might indicate a marginal RAM failure. The effects of this failure may not be immediately apparent.

# A. Troubleshooting

---

## **Windows 95 mach64 enhanced display driver**

The Windows 95 mach64 enhanced display driver is capable of using monitor timing data contained within Windows 95. This data is selected by configuring a monitor type at Windows 95 installation time or via the "Settings" page of the display properties sheet.

The Windows 95 mach64 enhanced display driver may incorrectly interpret Windows 95 monitor timing data for some older monitors which require interlaced modes. This may cause some options to be disabled. A solution to this problem is to select one of the "(Standard monitor types)" available via the settings page of the display properties sheet.

If you change the selected monitor type via the "Settings" page of the display properties sheet the new timing data may not take effect until after restarting Windows 95. A solution to this problem is to always restart Windows 95 after changing the monitor type.

In Windows 95, display drivers can be installed via the "Add New Hardware" wizard. This is not recommended because when the Windows 95 mach64 enhanced display driver is installed via the "Add New Hardware" wizard the "Settings" page does not get installed into the mach64 display adapter property sheet.

## **Windows 95 property page problems**

While adjusting monitor settings in the Adjustment page of the Display Properties sheet, your monitor could become unreadable. If this occurs, press the ESC key to return to your previous monitor settings.

## **ATI Video Player Notes**

**Q:** Why can my Video Player not execute in Windows 3.1 ?

**A:** The Video Player needs at least 600K DOS CONVENTIONAL MEMORY. You can try to close some programs to acquire more memory to use. If it still happens, return to DOS and run "MEMMAKER" in your DOS directory to modify your memory configuration. Quitting some DOS TSRs (Terminate and Stay Resident) programs also helps.

**Q:** After installing Xing MPEG Player, my ATI Video Player can not play Video CD even standard MPEG files.

**A:** Xing MPEG Player and ATI Video Player can not be installed together. They conflict with each other. The previously installed player will work abnormally. You can re-install ATI Video Player to recover it.

---

(This page was intentionally left blank)

---

(This page was intentionally left blank)