

**K8N4-E**



**Motherboard**

**E2141**

**First Edition  
July 2005**

**Copyright © 2005 ASUSTeK COMPUTER INC. All Rights Reserved.**

No part of this manual, including the products and software described in it, may be reproduced, transmitted, transcribed, stored in a retrieval system, or translated into any language in any form or by any means, except documentation kept by the purchaser for backup purposes, without the express written permission of ASUSTeK COMPUTER INC. ("ASUS").

Product warranty or service will not be extended if: (1) the product is repaired, modified or altered, unless such repair, modification or alteration is authorized in writing by ASUS; or (2) the serial number of the product is defaced or missing.

ASUS PROVIDES THIS MANUAL "AS IS" WITHOUT WARRANTY OF ANY KIND, EITHER EXPRESS OR IMPLIED, INCLUDING BUT NOT LIMITED TO THE IMPLIED WARRANTIES OR CONDITIONS OF MERCHANTABILITY OR FITNESS FOR A PARTICULAR PURPOSE. IN NO EVENT SHALL ASUS, ITS DIRECTORS, OFFICERS, EMPLOYEES OR AGENTS BE LIABLE FOR ANY INDIRECT, SPECIAL, INCIDENTAL, OR CONSEQUENTIAL DAMAGES (INCLUDING DAMAGES FOR LOSS OF PROFITS, LOSS OF BUSINESS, LOSS OF USE OR DATA, INTERRUPTION OF BUSINESS AND THE LIKE), EVEN IF ASUS HAS BEEN ADVISED OF THE POSSIBILITY OF SUCH DAMAGES ARISING FROM ANY DEFECT OR ERROR IN THIS MANUAL OR PRODUCT.

SPECIFICATIONS AND INFORMATION CONTAINED IN THIS MANUAL ARE FURNISHED FOR INFORMATIONAL USE ONLY, AND ARE SUBJECT TO CHANGE AT ANY TIME WITHOUT NOTICE, AND SHOULD NOT BE CONSTRUED AS A COMMITMENT BY ASUS. ASUS ASSUMES NO RESPONSIBILITY OR LIABILITY FOR ANY ERRORS OR INACCURACIES THAT MAY APPEAR IN THIS MANUAL, INCLUDING THE PRODUCTS AND SOFTWARE DESCRIBED IN IT.

Products and corporate names appearing in this manual may or may not be registered trademarks or copyrights of their respective companies, and are used only for identification or explanation and to the owners' benefit, without intent to infringe.

# Contents

Notices .....	vi
Safety information .....	vii
About this guide .....	viii
How this guide is organized .....	viii
Where to find more information .....	viii
Conventions used in this guide .....	ix
Typography .....	ix
K8N4-E specifications summary .....	x

## Chapter 1: Product introduction

1.1	Welcome! .....	1-2
1.2	Package contents .....	1-2
1.3	Special features .....	1-3
1.3.1	Product highlights .....	1-3
1.3.2	ASUS Proactive features .....	1-5
1.3.3	Innovative ASUS features .....	1-5
1.4	Before you proceed .....	1-7
1.5	Motherboard overview .....	1-8
1.5.1	Placement direction .....	1-8
1.5.2	Screw holes .....	1-8
1.5.3	Motherboard layout .....	1-9
1.6	Central Processing Unit (CPU) .....	1-10
1.6.1	Overview .....	1-10
1.6.2	Installing the CPU .....	1-10
1.6.3	Installing the heatsink and fan .....	1-12
1.7	System memory .....	1-15
1.7.1	Overview .....	1-15
1.7.2	Memory Configurations .....	1-15
1.7.3	Installing a DIMM .....	1-19
1.7.4	Removing a DIMM .....	1-19
1.8	Expansion slots .....	1-20
1.8.1	Installing an expansion card .....	1-20
1.8.2	Configuring an expansion card .....	1-20
1.8.3	Interrupt assignments .....	1-21
1.8.4	PCI slots .....	1-21

# Contents

1.8.5	PCI Express x16 slot .....	1-22
1.8.6	PCI Express x1 slot .....	1-22
1.9	Jumpers .....	1-23
1.10	Connectors .....	1-25
1.10.1	Rear panel connectors .....	1-25
1.10.2	Internal connectors .....	1-26

## Chapter 2: BIOS setup

2.1	Managing and updating your BIOS .....	2-2
2.1.1	Creating a bootable floppy disk .....	2-2
2.1.2	Updating the BIOS .....	2-3
2.1.3	Saving the current BIOS file .....	2-5
2.1.4	ASUS CrashFree BIOS 2 utility .....	2-6
2.1.5	ASUS EZ Flash utility .....	2-8
2.1.6	ASUS Update utility .....	2-9
2.2	BIOS setup program .....	2-12
2.2.1	BIOS menu screen .....	2-13
2.2.2	Menu bar .....	2-13
2.2.3	Legend bar .....	2-14
2.2.4	Menu items .....	2-14
2.2.5	Sub-menu items .....	2-14
2.2.6	Configuration fields .....	2-14
2.2.8	General help .....	2-15
2.2.7	Pop-up window .....	2-15
2.3	Main menu .....	2-16
2.3.1	System Time .....	2-16
2.3.2	System Date .....	2-16
2.3.3	Language .....	2-16
2.3.4	Legacy Diskette A .....	2-16
2.3.5	Primary and Secondary IDE Master/Slave .....	2-17
2.3.6	First, Second, Third, Fourth SATA Master .....	2-19
4.3.7	HDD SMART Monitoring .....	2-20
4.3.8	Installed Memory .....	2-20
2.4	Advanced menu .....	2-21
2.4.1	JumperFree Configuration .....	2-21

# Contents

2.4.2	LAN Cable Status .....	2-23
2.4.3	CPU Configuration .....	2-23
2.4.4	PCIPnP .....	2-25
2.4.5	Onboard Devices Configuration .....	2-26
2.4.6	Instant Music .....	2-29
2.5	Power menu .....	2-30
2.5.1	ACPI Suspend Type .....	2-30
2.5.2	ACPI APIC Support .....	2-30
2.5.3	APM Configuration .....	2-31
2.5.4	Hardware Monitor .....	2-33
2.6	Boot menu .....	2-34
2.6.1	Boot Device Priority .....	2-34
2.6.2	Removable Drives .....	2-35
2.6.3	Hard Disk Drives .....	2-35
2.6.4	CDROM Drives .....	2-35
2.6.5	Boot Settings Configuration .....	2-36
2.6.6	Security .....	2-37
2.7	Exit menu .....	2-39

## Chapter 3: Software support

3.1	Installing an operating system .....	3-2
3.2	Support CD information .....	3-2
3.2.1	Running the support CD .....	3-2
3.2.2	Drivers menu .....	3-3
3.2.3	Utilities menu .....	3-4
3.2.4	ASUS Contact information .....	3-6

# Notices

## Federal Communications Commission Statement

This device complies with Part 15 of the FCC Rules. Operation is subject to the following two conditions:

- This device may not cause harmful interference, and
- This device must accept any interference received including interference that may cause undesired operation.

This equipment has been tested and found to comply with the limits for a Class B digital device, pursuant to Part 15 of the FCC Rules. These limits are designed to provide reasonable protection against harmful interference in a residential installation. This equipment generates, uses and can radiate radio frequency energy and, if not installed and used in accordance with manufacturer's instructions, may cause harmful interference to radio communications. However, there is no guarantee that interference will not occur in a particular installation. If this equipment does cause harmful interference to radio or television reception, which can be determined by turning the equipment off and on, the user is encouraged to try to correct the interference by one or more of the following measures:

- Reorient or relocate the receiving antenna.
- Increase the separation between the equipment and receiver.
- Connect the equipment to an outlet on a circuit different from that to which the receiver is connected.
- Consult the dealer or an experienced radio/TV technician for help.



---

The use of shielded cables for connection of the monitor to the graphics card is required to assure compliance with FCC regulations. Changes or modifications to this unit not expressly approved by the party responsible for compliance could void the user's authority to operate this equipment.

---

## Canadian Department of Communications Statement

This digital apparatus does not exceed the Class B limits for radio noise emissions from digital apparatus set out in the Radio Interference Regulations of the Canadian Department of Communications.

**This class B digital apparatus complies with Canadian ICES-003.**

# Safety information

## Electrical safety

- To prevent electrical shock hazard, disconnect the power cable from the electrical outlet before relocating the system.
- When adding or removing devices to or from the system, ensure that the power cables for the devices are unplugged before the signal cables are connected. If possible, disconnect all power cables from the existing system before you add a device.
- Before connecting or removing signal cables from the motherboard, ensure that all power cables are unplugged.
- Seek professional assistance before using an adapter or extension cord. These devices could interrupt the grounding circuit.
- Make sure that your power supply is set to the correct voltage in your area. If you are not sure about the voltage of the electrical outlet you are using, contact your local power company.
- If the power supply is broken, do not try to fix it by yourself. Contact a qualified service technician or your retailer.

## Operation safety

- Before installing the motherboard and adding devices on it, carefully read all the manuals that came with the package.
- Before using the product, make sure all cables are correctly connected and the power cables are not damaged. If you detect any damage, contact your dealer immediately.
- To avoid short circuits, keep paper clips, screws, and staples away from connectors, slots, sockets and circuitry.
- Avoid dust, humidity, and temperature extremes. Do not place the product in any area where it may become wet.
- Place the product on a stable surface.
- If you encounter technical problems with the product, contact a qualified service technician or your retailer.

# About this guide

This user guide contains the information you need when installing and configuring the motherboard.

## How this guide is organized

This manual contains the following parts:

- **Chapter 1: Product introduction**  
This chapter describes the features of the motherboard and the new technology it supports. It also lists the hardware setup procedures that you have to perform when installing system components. It includes description of the jumpers and connectors on the motherboard.
- **Chapter 2: BIOS setup**  
This chapter tells how to change system settings through the BIOS Setup menus. Detailed descriptions of the BIOS parameters are also provided.
- **Chapter 3: Software support**  
This chapter describes the contents of the support CD that comes with the motherboard package.

## Where to find more information

Refer to the following sources for additional information and for product and software updates.

### 1. ASUS websites

The ASUS website provides updated information on ASUS hardware and software products. Refer to the ASUS contact information.

### 2. Optional documentation

Your product package may include optional documentation, such as warranty flyers, that may have been added by your dealer. These documents are not part of the standard package.



## Conventions used in this guide

To make sure that you perform certain tasks properly, take note of the following symbols used throughout this manual.



**DANGER/WARNING:** Information to prevent injury to yourself when trying to complete a task.



**CAUTION:** Information to prevent damage to the components when trying to complete a task.



**IMPORTANT:** Instructions that you **MUST** follow to complete a task.



**NOTE:** Tips and additional information to help you complete a task.

## Typography

**Bold text**

Indicates a menu or an item to select

*Italics*

Used to emphasize a word or a phrase

<Key>

Keys enclosed in the less-than and greater-than sign means that you must press the enclosed key

Example: <Enter> means that you must press the Enter or Return key

<Key1+Key2+Key3>

If you must press two or more keys simultaneously, the key names are linked with a plus sign (+)

Example: <Ctrl+Alt+D>

**Command**

Means that you must type the command exactly as shown, then supply the required item or value enclosed in brackets

Example:

At the DOS prompt, type the command line:

**awdf`lash` K8N4-EB.ROM**

## K8N4-E specifications summary

<b>CPU</b>	Socket 754 for AMD Athlon™ 64/AMD Sempron™ processors AMD64 architecture enables simultaneous 32- and 64-bit computing Supports AMD Cool 'n' Quiet™ Technology
<b>Chipset</b>	NVIDIA® nForce™4-4X
<b>System bus</b>	1600 MT per second
<b>Memory</b>	3 x 184-pin DIMM sockets support unbuffered non-ECC 400/333/266 MHz DDR memory modules Supports up to 3GB system memory
<b>Expansion slots</b>	1 x PCI Express™ x16 slot for discrete graphics card 3 x PCI Express™ x1 slots 3 x PCI slots
<b>Storage</b>	NVIDIA® nForce™4-4X chipset supports: <ul style="list-style-type: none"> <li>- 4 x Ultra DMA 133/100/66/33 hard disks</li> <li>- 4 x Serial ATA hard disks with RAID 0, RAID 1, RAID 0+1, and JBOD configurations</li> </ul>
<b>AI Audio</b>	Realtek® ALC850 6-channel CODEC Audio Sensing and Enumeration Technology support 3 x Universal Audio Jacks (UAJ®) 1 x Coaxial S/PDIF out port
<b>USB</b>	Supports up to 10 USB 2.0 ports
<b>LAN</b>	Marvell® 88E81111 Gigabit LAN PHY Supports Marvell® Virtual Cable Tester Technology
<b>BIOS features</b>	4 Mb Flash ROM, Phoenix-AWARD BIOS, PnP, DMI2.0, SM BIOS 2.3, WfM2.0
<b>ASUS AI Proactive Feature</b>	AI NET 2
<b>Special features</b>	ASUS CrashFree BIOS 2 ASUS Multi-language BIOS ASUS MyLogo™ 2 ASUS Instant Music NVIDIA® Firewall

*(continued on the next page)*

## K8N4-E specifications summary

<b>Overclocking features</b>	ASUS AI Overclocking (intelligent CPU frequency tuner) ASUS C.P.R. (CPU Parameter Recall) Precision Tweaker: <ul style="list-style-type: none"> <li>- DIMM voltage: 9-step DRAM voltage control</li> <li>- vCore: Adjustable CPU voltage at 0.025 increment</li> <li>- Stepless Frequency Selection (SFS) allows FSB tuning from 200 MHz up to 400 MHz at 1 MHz increment</li> <li>- PCIe Frequency allows PCI Express frequency adjustment from 100 MHz up to 145 MHz at 1 MHz increment</li> </ul>
<b>Internal connectors</b>	1 x Floppy disk drive connector 1 x Primary IDE connector 1 x Secondary IDE connector 4 x Serial ATA connectors 1 x CPU fan connector 1 x Chipset fan connector 1 x Chassis fan connector 1 x Power fan connector 3 x USB 2.0 connectors 1 x S/PDIF out connector 1 x 24-pin ATX power connector 1 x 4-pin ATX 12 V power connector 1 x CD audio connector 1 x AUX connector 1 x Game/MIDI port connector 1 x Chassis intrusion connector 1 x Front panel audio connector 1 x System panel connector
<b>Rear panel</b>	1 x PS/2 mouse port 1 x Parallel port 1 x LAN (RJ-45) port 4 x USB 2.0 ports 1 x Serial (COM1) port 1 x Coaxial S/PDIF out port 1 x PS/2 keyboard port 6-Channel audio ports
<b>Support CD contents</b>	Drivers ASUS PC Probe II ASUS Live Update ASUS Cool 'n' Quiet!™ utility NVIDIA® nTune™ utility Anti-virus software (OEM version)
<b>Form factor</b>	ATX form factor: 12 in x 9.6 in (30.5 cm x 24.5 cm)

\*Specifications are subject to change without notice.



This chapter describes the motherboard features and the new technologies it supports.

# Product introduction



## 1.1 Welcome!

Thank you for buying an ASUS® K8N4-E motherboard!

The motherboard delivers a host of new features and latest technologies, making it another standout in the long line of ASUS quality motherboards!

Before you start installing the motherboard, and hardware devices on it, check the items in your package with the list below.

## 1.2 Package contents

Check your motherboard package for the following items.

<b>Motherboard</b>	ASUS K8N4-E motherboard
<b>I/O module</b>	1 x 2-port USB 2.0/Game module 1 x 2-port USB 2.0 module
<b>Cables</b>	1 x 2-in-1 FDD/IDE(/ATA) cable 1 x Serial ATA kit
<b>Accessory</b>	I/O shield
<b>Application CD</b>	ASUS motherboard support CD
<b>Documentation</b>	User guide



If any of the above items is damaged or missing, contact your retailer.

## 1.3 Special features

### 1.3.1 Product highlights

#### Latest processor technology



The motherboard comes with a 754-pin surface mount, Zero Insertion Force (ZIF) socket that supports AMD Athlon™ 64/AMD Sempron™ processors. With an integrated low-latency high-bandwidth memory controller and a highly-scalable HyperTransport™ technology-based system bus, the motherboard provides a powerful platform for your diverse computing needs, increased office productivity, and enhanced digital media experience. See page 1-10.

#### NVIDIA® nForce™4-4X chipset



The NVIDIA® nForce™4-4X chipset supports the vital interfaces of the motherboard in a single chip architecture for 64-bit platforms. The NVIDIA® nForce™4-4X chipset features PCI Express™ support for the latest graphics and expansion cards, increased security with NVIDIA® Firewall™, and advanced storage solutions with NVIDIA® RAID technology for faster and more reliable computing.

#### Built-in NVFirewall™



The NVIDIA® Firewall™ (NVFirewall™) is an easy-to-use high-performance desktop firewall application that protects your system from intruders. Integrated into the NVIDIA® nForce4®-4X chipset with the NVIDIA® Gigabit Ethernet, it provides advanced anti-computer-hacking technologies, remote management capabilities, and a user-friendly setup wizard that improves overall system security.

#### AMD Cool 'n' Quiet!™ Technology



The motherboard supports the AMD Cool 'n' Quiet!™ Technology that dynamically and automatically changes the CPU speed, voltage and amount of power depending on the task the CPU performs. See page 2-24 for details.

## PCI Express™ interface

The motherboard fully supports PCI Express, the latest I/O interconnect technology that speeds up the PCI bus. PCI Express features point-to-point serial interconnections between devices and allows higher clockspeeds by carrying data in packets. This high speed interface is software compatible with existing PCI specifications. See page 1-22 for details.

## S/PDIF digital sound ready

The motherboard supports the S/PDIF Out function through the S/PDIF interfaces on the rear panel and at midboard. The S/PDIF technology turns your computer into a high-end entertainment system with digital connectivity to powerful audio and speaker systems. See page 1-26 for details.

## 6-channel high definition audio

Onboard is the Realtek ALC850 High Definition Audio solution with 6-channel CODEC, featuring Audio Sensing and Enumeration Technology support. With the CODEC, 6-channel audio ports, and S/PDIF interfaces, you can connect your computer to home theater decoders to produce crystal-clear digital audio.

The Realtek ALC850 audio CODEC comes with a software application that features jack detection to monitor the plugging status of each jack, impedance sensing to determine audio device classes, and pre-defined equalization for various audio devices. See page 1-26 for details.

## Serial ATA technology

The motherboard supports the Serial ATA technology through the Serial ATA interfaces and the NVIDIA® nForce™4-4X chipset. The Serial ATA specification allows for thinner, more flexible cables with lower pin count, reduced voltage requirement, and up to 150 MB/s data transfer rate. See page 1-28 for details.

## Gigabit LAN

The motherboard comes with a Gigabit LAN controller built into the NVIDIA® nForce™4-4X chipset to meet your growing networking needs. The controller uses the PCI Express segment to provide faster data bandwidth for your Internet, LAN, and file sharing requirements. See page 1-25 for details.



## USB 2.0 technology

The motherboard implements the Universal Serial Bus (USB) 2.0 specification, dramatically increasing the connection speed from the 12 Mbps bandwidth on USB 1.1 to a fast 480 Mbps on USB 2.0. USB 2.0 is backward compatible with USB 1.1. See pages 1-26 and 1-30 for details.

### 1.3.2 ASUS Proactive features

#### AI NET 2

AI NET 2 is a BIOS-based diagnostic tool that detects and reports Ethernet cable faults and shorts. With this utility, you can easily monitor the condition of the Ethernet cable(s) connected to the LAN (RJ-45) port(s). During the bootup process, AI NET 2 immediately diagnoses the LAN cable(s) and reports shorts and faults up to 100 meters at 1 meter accuracy. See page 1-25 for details.

#### AI Audio technology

The motherboard supports 6-channel audio through the onboard ALC850 CODEC with 16-bit DAC, a stereo 16-bit ADC, and an AC97 2.3 compatible multi-channel audio designed for PC multimedia systems. It also provides Jack-Sensing function, S/PDIF out support, interrupt capability and includes the Realtek® proprietary UAJ® (Universal Audio Jack) technology. See pages 1-25 and 1-26 for details.

### 1.3.3 Innovative ASUS features

#### ASUS CrashFree BIOS 2

This feature allows you to restore the original BIOS data from the support CD in case when the BIOS codes and data are corrupted. This protection eliminates the need to buy a replacement ROM chip. See page 2-6 for details.

#### ASUS Q-Fan technology

The ASUS Q-Fan technology smartly adjusts the CPU fan speed according to the system loading to ensure quiet, cool, and efficient operation. See page 2-33 for details.

## ASUS Multi-language BIOS



The multi-language BIOS allows you to select the language of your choice from the available options. The localized BIOS menus allow you to configure easier and faster. Visit the ASUS website for information on the supported languages. See page 2-16 for details.

## ASUS EZ Flash BIOS



With the ASUS EZ Flash, you can easily update the system BIOS even before loading the operating system. No need to use a DOS-based utility or boot from a floppy disk. See page 2-8 for details.

## ASUS MyLogo2™



This feature allows you to personalize and add style to your system with customizable boot logos.

## ASUS Instant Music Lite



This unique feature allows you to play back audio files even before entering the operating system. Just press the ASUS Instant Music special function keys and enjoy the music!

## 1.4 Before you proceed

Take note of the following precautions before you install motherboard components or change any motherboard settings.



- Unplug the power cord from the wall socket before touching any component.
- Use a grounded wrist strap or touch a safely grounded object or to a metal object, such as the power supply case, before handling components to avoid damaging them due to static electricity
- Hold components by the edges to avoid touching the ICs on them.
- Whenever you uninstall any component, place it on a grounded antistatic pad or in the bag that came with the component.
- **Before you install or remove any component, ensure that the ATX power supply is switched off or the power cord is detached from the power supply.** Failure to do so may cause severe damage to the motherboard, peripherals, and/or components.

### Onboard LEDs

The motherboard comes with a green standby power LED that lights up to indicate that the system is ON, in sleep mode, or in soft-off mode. This is a reminder that you should shut down the system and unplug the power cable before removing or plugging in any motherboard component.

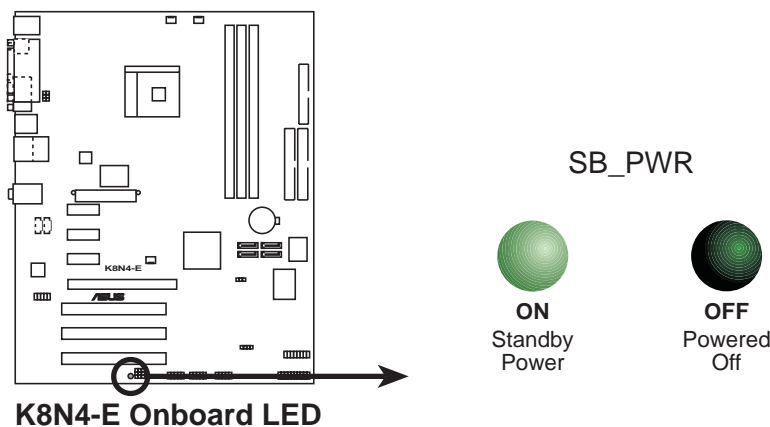

## 1.5 Motherboard overview

Before you install the motherboard, study the configuration of your chassis to ensure that the motherboard fits into it.



Make sure to unplug the power cord before installing or removing the motherboard. Failure to do so can cause you physical injury and damage motherboard components.

### 1.5.1 Placement direction

When installing the motherboard, make sure that you place it into the chassis in the correct orientation. The edge with external ports goes to the rear part of the chassis as indicated in the image below.

### 1.5.2 Screw holes

Place nine (9) screws into the holes indicated by circles to secure the motherboard to the chassis.



Do not overtighten the screws! Doing so can damage the motherboard.

Place this side towards  
the rear of the chassis

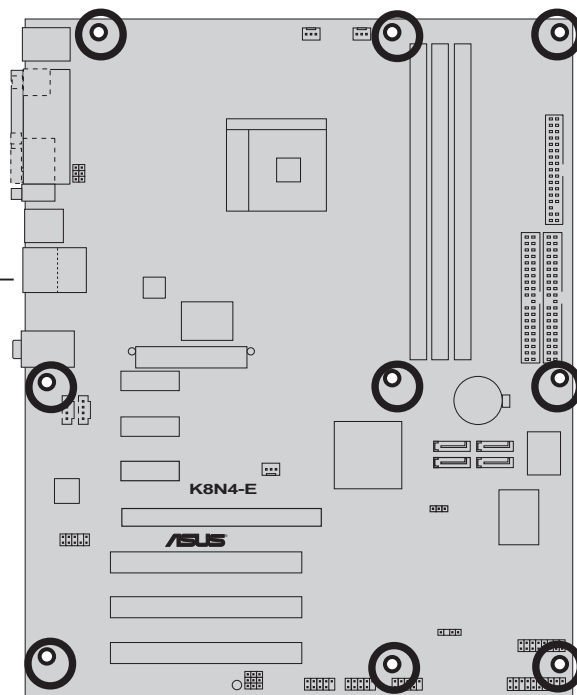

# 1.5.3 Motherboard layout

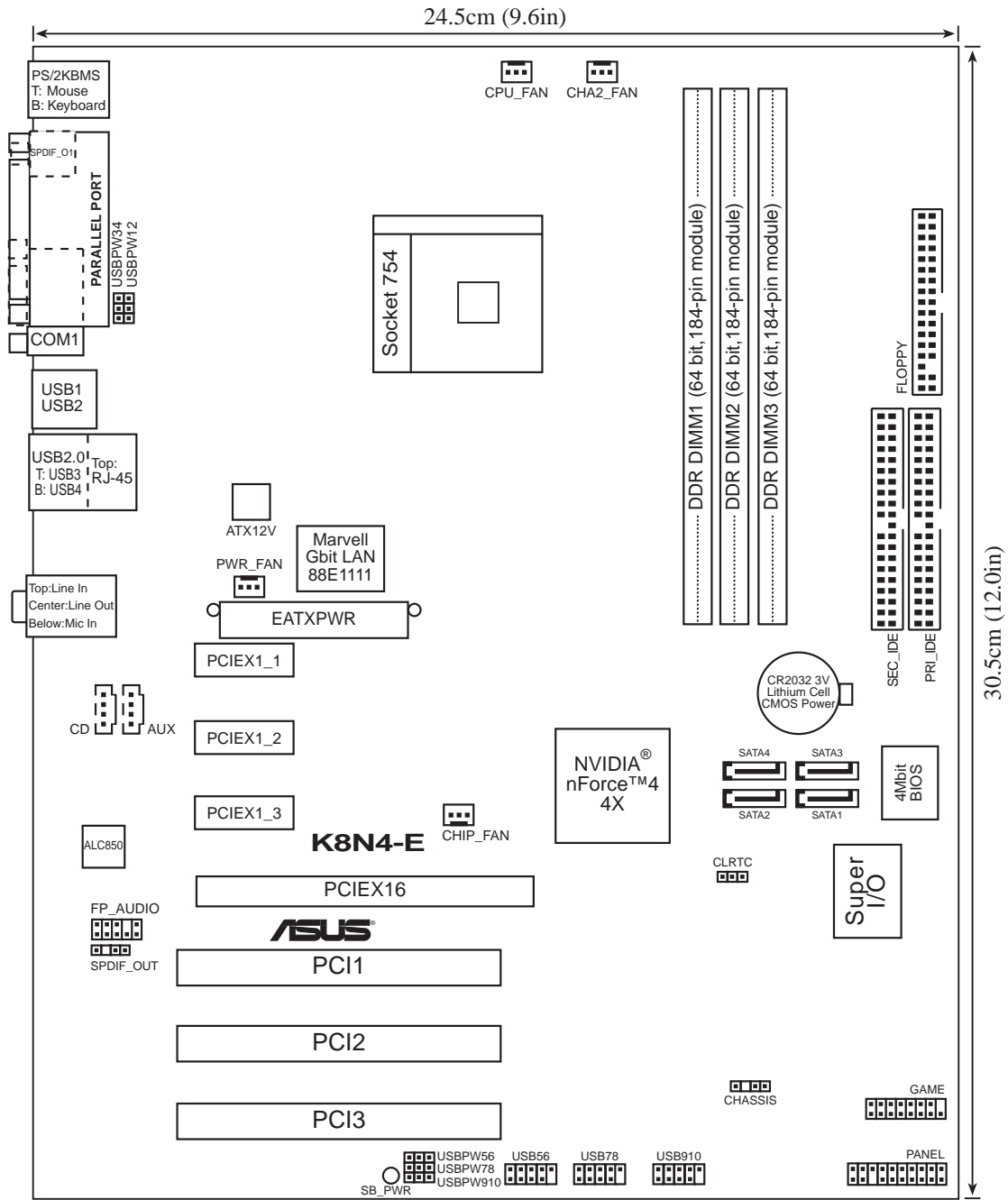

## 1.6 Central Processing Unit (CPU)

### 1.6.1 Overview

The motherboard comes with a surface mount 754-pin Zero Insertion Force (ZIF) socket designed for the AMD Athlon™ 64/ AMD Sempron™ processor.

Take note of the marked corner (with gold triangle) on the CPU. This mark should match a specific corner on the socket to ensure correct installation.

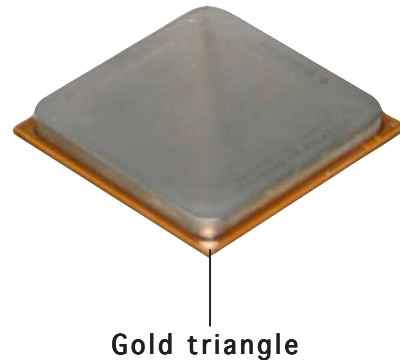

### 1.6.2 Installing the CPU

To install a CPU:

1. Locate the CPU socket on the motherboard.

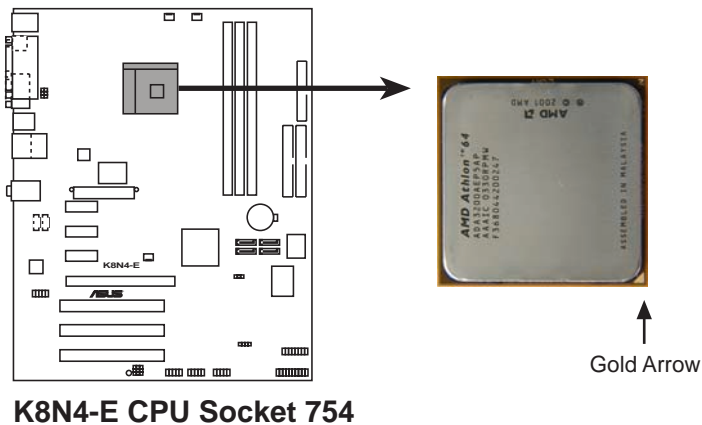

Before installing the CPU, make sure that the socket box is facing towards you and the load lever is on your left.

2. Unlock the socket by pressing the lever sideways, then lift it up to a 90°-100° angle.



---

Make sure that the socket lever is lifted up to 90°-100° angle; otherwise the CPU does not fit in completely.

---

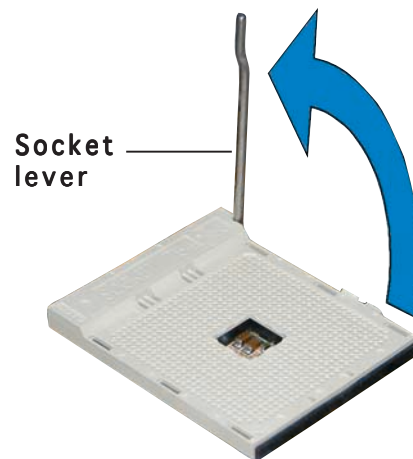

3. Position the CPU above the socket such that the CPU corner with the gold triangle matches the socket corner with a small triangle.

4. Carefully insert the CPU into the socket until it fits in place.

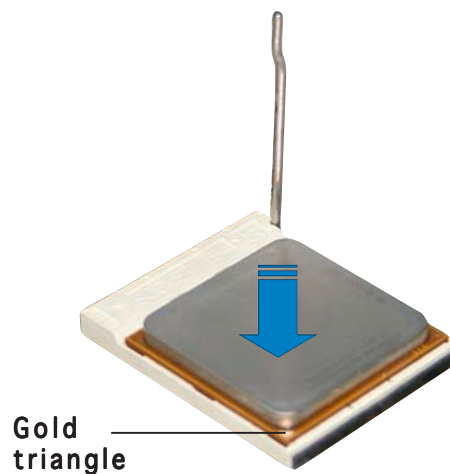

5. When the CPU is in place, push down the socket lever to secure the CPU. The lever clicks on the side tab to indicate that it is locked.
6. Install a CPU heatsink and fan following the instructions that came with the heatsink package.
7. Connect the CPU fan cable to the CPU\_FAN connector on the motherboard.

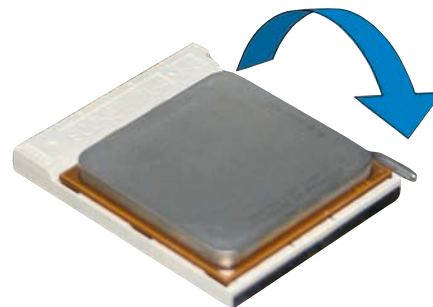

## 1.6.3 Installing the heatsink and fan

The AMD Athlon™ 64FX or AMD Athlon 64™ processor require a specially designed heatsink and fan assembly to ensure optimum thermal condition and performance.



---

Make sure that you use only qualified heatsink and fan assembly.

---

Follow these steps to install the CPU heatsink and fan.

1. Place the heatsink on top of the installed CPU, making sure that the heatsink fits properly on the retention module base.



- The retention module base is already installed on the motherboard upon purchase.
  - You do not have to remove the retention module base when installing the CPU or installing other motherboard components.
  - If you purchased a separate CPU heatsink and fan assembly, make sure that a Thermal Interface Material is properly applied to the CPU heatsink or CPU before you install the heatsink and fan assembly.
- 

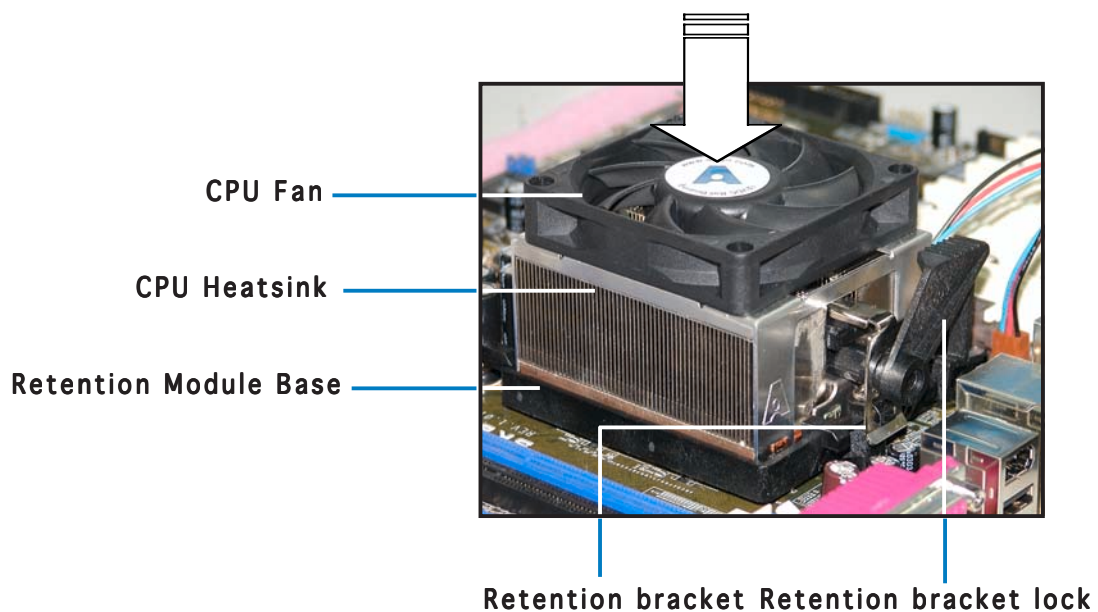

---

Your boxed CPU heatsink and fan assembly should come with installation instructions for the CPU, heatsink, and the retention mechanism. If the instructions in this section do not match the CPU documentation, follow the latter.

---



2. Attach one end of the retention bracket to the retention module base.

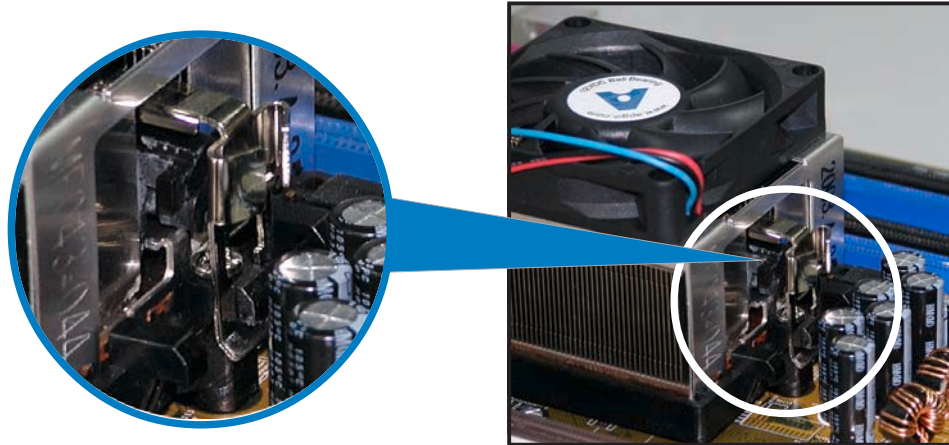

3. Align the other end of the retention bracket (near the retention bracket lock) to the retention module base. A clicking sound denotes that the retention bracket is in place.



Make sure that the fan and heatsink assembly perfectly fits the retention mechanism module base, otherwise you cannot snap the retention bracket in place.



4. Push down the retention bracket lock on the retention mechanism to secure the heatsink and fan to the module base.

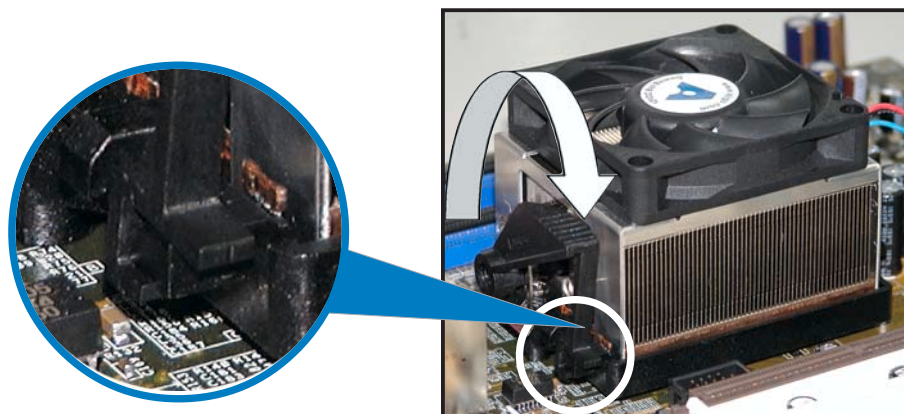

3. When the fan and heatsink assembly is in place, connect the CPU fan cable to the connector on the motherboard labeled CPU\_FAN.

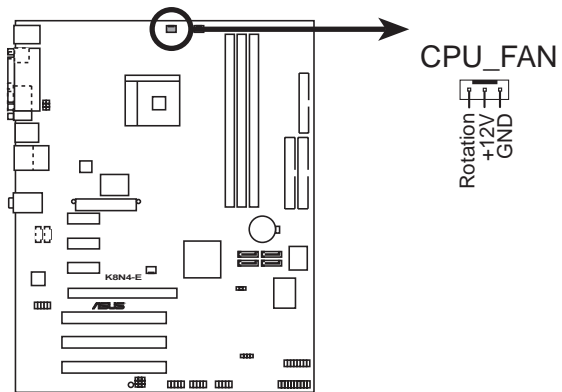

**K8N4-E CPU fan connector**



---

Do not forget to connect the CPU fan connector! Hardware monitoring errors can occur if you fail to plug this connector.

---

## 1.7 System memory

### 1.7.1 Overview

The motherboard comes with four 184-pin Double Data Rate (DDR) Dual Inline Memory Modules (DIMM) sockets.

The following figure illustrates the location of the sockets:

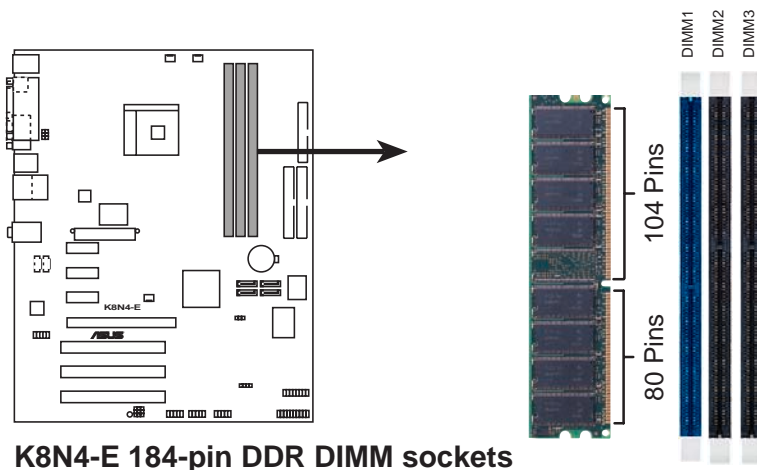

K8N4-E 184-pin DDR DIMM sockets

### 1.7.2 Memory Configurations

You may install 256 MB, 512 MB, and 1 GB unbuffered non-ECC DDR DIMMs into the DIMM sockets using the memory configurations in this section.



- Installing DDR DIMMs other than the recommended configurations may cause memory sizing error or system boot failure. Use any of the recommended configurations on the next page.
- Always install DIMMs with the same CAS latency. For optimum compatibility, we recommend that you obtain memory modules from the same vendor.
- Due to chipset resource allocation, the system may detect less than 3 GB system memory when you installed three 1 GB DDR memory modules.
- This motherboard does not support memory modules made up of 128 Mb chips or double sided x16 memory modules.

## Recommended DDR memory configurations

Number of DIMMs	DIMM slot			Max Speed
	DIMM1	DIMM2	DIMM3	
1	Single side	-	-	DDR 400
1	-	Single side	-	DDR 400
1	-	-	Single side	DDR 400
1	Double side	-	-	DDR 400
1	-	Double side	-	DDR 400
1	-	-	Double side	DDR 400
2	Single side	Single side	-	DDR 400
2	Single side	Double side	-	DDR 400
2	Single side	-	Single side	DDR 400
2	Single side	-	Double side	DDR 400
2	Double side	Single side	-	DDR 400
2	Double side	Double side	-	DDR 400
2	Double side	-	Single side	DDR 400
2	-	Single side	Single side	DDR 333
2	-	Single side	Double side	DDR 200
2	-	Double side	Single side	DDR 200
2	-	Double side	Double side	DDR 200
2	Double side	-	Double side	DDR 400
3	Single side	Single side	Single side	DDR 333
3	Single side	Single side	Double side	DDR 200
3	Single side	Double side	Single side	DDR 200
3	Single side	Double side	Double side	DDR 200
3	Double side	Single side	Single side	DDR 333
3	Double side	Single side	Double side	DDR 200
3	Double side	Double side	Single side	DDR 200
3	Double side	Double side	Double side	DDR 200

## DDR (400 MHz) Qualified Vendors List

							DIMM support
Size	Vendor	Model	Brand	Side/s*	Component	CL	
256MB	KINGSTON	KVR400X64C3A/256	Hynix	SS	HY5DU56822BT-D43	-	
512MB	KINGSTON	KVR400X64C3A/512	Hynix	DS	HY5DU56822BT-D43	-	
256MB	KINGSTON	KVR400X72C3A/256	Mosel	SS	V58C2256804SAT5(ECC)	-	
512MB	KINGSTON	KVR400X72C3A/512	Mosel	DS	V58C2256804SAT5(ECC)	-	
256MB	KINGSTON	KVR400X64C3A/256	Infineon	SS	HYB25D256800BT-5B	-	
512MB	KINGSTON	KVR400X64C3A/512	Infineon	DS	HYB25D256809BT-5B	-	
256MB	KINGSTON	KVR400X64C3A/256	KINGSTON	SS	D3208DL2T-5	-	
512MB	KINGSTON	KHX3200A/512	-	DS	-	3	
1024MB	KINGSTON	KVR400X64C3A/1G	-	DS	HYB25D512800BE-5B	3	
1024MB	KINGSTON	KHX3200ULK2/1G	-	DS	-	2	
256MB	SAMSUNG	M381L3223ETM-CCC	SAMSUNG	SS	K4H560838E-TCCC(ECC)	3ECC	
512MB	SAMSUNG	M381L6423ETM-CCC	SAMSUNG	DS	K4H560838E-TCCC(ECC)	-	
256MB	SAMSUNG	M368L3223ETM-CCC	SAMSUNG	SS	K4H560838E-TCCC	-	
256MB	SAMSUNG	M368L3223FTN-CCC	SAMSUNG	SS	K4H560838F-TCCC	4	
512MB	SAMSUNG	M368L6423FTN-CCC	SAMSUNG	DS	K4H560838F-TCCC	4	
512MB	SAMSUNG	M368L6523BTM-CCC	SAMSUNG	SS	K4H510838B-TCCC	4	
256MB	MICRON	MT8VDDT3264AG-40BCB	MICRON	SS	MT46V32M8TG-5BC	-	
512MB	MICRON	MT16VDDT6464AG-40BCB	MICRON	DS	MT46V32M8TG-5BC	-	
256MB	Infineon	HYS64D32300HU-5-C	Infineon	SS	HYB25D256800CE-5C	3	
512MB	Infineon	HYS64D64320HU-5-C	Infineon	DS	HYB25D256800CE-5C	-	
256MB	CORSAIR	CMX256A-3200C2PT	Winbond	SS	W942508BH-5	2	
512MB	CORSAIR	VS512MB400	VALUE seLecT	DS	VS32M8-5 2.5		
512MB	CORSAIR	CMX512-3200C2	-	DS	-	3	
1024MB	CORSAIR	TWINX2048-3200C2	-	DS	-	-	
256MB	Hynix	HYMD232645D8J-D43	Hynix	SS	HY5DU56822DT-D43	3	
512MB	Hynix	HYMD264646D8J-D43	Hynix	DS	HY5DU56822DT-D43	3	
256MB	TwinMOS	M2G9I08AIATT9F081AADT	TwinMOS	SS	TMD7608F8E50D	2.5	
512MB	TwinMOS	M2G9J16AJATT9F081AADT	TwinMOS	DS	TMD7608F8E50D	2.5	
256MB	TwinMOS	M2G9I08A8ATT9F081AADT	TwinMOS	SS	TMD7608F8E50D	2.5	
512MB	TwinMOS	M2G9J16A8ATT9F081AADT	TwinMOS	DS	TMD7608F8E50D	2.5	
256MB	Transcend	TS32MLD64V4F3	SAMSUNG	SS	K4H560838F-TCCC	3	
512MB	Transcend	TS64MLD64V4F3	SAMSUNG	DS	K4H560838F-TCCC	3	
1024MB	Transcend	TS128MLD64V4J	SAMSUNG	DS	K4H510838B-TCCC	3	
256MB	Apacer	77.10636.33G	Infineon	SS	HYB25D256800CE-5C	3	
512MB	Apacer	77.10736.33G	Infineon	DS	HYB25D256800CE-5C	3	
256MB	Apacer	77.10639.60G	ProMOS	SS	V58C2256804SCT5B	2.5	
512MB	Apacer	77.10739.60G	ProMOS	DS	V58C2256804SCT5B	2.5	
256MB	A DATA	MDOSS6F3G31Y0K1E0Z	SAMSUNG	SS	K4H560838E-TCCC	3	
512MB	A DATA	MDOSS6F3H41Y0N1E0Z	SAMSUNG	DS	K4H560838F-TCCC	3	
256MB	A DATA	MDOHY6F3G31Y0N1E0Z	Hynix	SS	HY5DU56822CT-D43	3	
512MB	A DATA	MDOHY6F3H41Y0N1E0Z	Hynix	DS	HY5DU56822CT-D43	3	
256MB	A DATA	MDOAD5F3G31Y0D1E02	-	SS	ADD8608A8A-5B	2.5	
512MB	A DATA	MDOAD5F3H41Y0D1E02	-	DS	ADD8608A8A-5B	2.5	
256MB	Winbond	W9425GCDB-5	Winbond	SS	W942508CH-5	3	
512MB	Winbond	W9451GCDB-5	Winbond	DS	W942508CH-5	-	
256MB	PSC	AL5D8B53T-5B1K	PSC	SS	A2S56D30BTP	2.5	

## DDR (400 MHz) Qualified Vendors List

							DIMM support
Size	Vendor	Model	Brand	Side/s*	Component	CL	
512MB	PSC	AL6D8B53T-5B1K	PSC	DS	A2S56D30BTP	2.5	
256MB	KINGMAX	MPXB62D-38KT3R	-	SS	KDL388P4LA-50	-	
512MB	KINGMAX	MPXC22D-38KT3R	-	DS	KDL388P4LA-50	-	
256MB	NANYA	NT256D64S88COG-5T	-	SS	NT5DS32M8CT-5T	3	
512MB	NANYA	NT512D64S8HCOG-5T	-	DS	NT5DS32M8CT-5T	3	
256MB	BRAIN POWER	B6U808-256M-SAM-400	SAMSUNG	SS	K4H560838D-TCC4	-	
512MB	BRAIN POWER	B6U808-512M-SAM-400	SAMSUNG	DS	K4H560838D-TCC4	-	
256MB	CENTURY	DXV6S8SSCCE3K27E	SAMSUNG	SS	K4H560838E-TCCC	-	
512MB	CENTURY	DXV2S8SSCCE3K27E	SAMSUNG	DS	K4H560838E-TCCC	-	
256MB	CENTURY	DXV6S8EL5BM3T27C	-	SS	DD2508AMTA	-	
512MB	CENTURY	DXV2S8EL5BM3T27C	-	DS	DD2508AMTA	-	
256MB	elixir	M2U25664DS88C3G-5T	-	SS	N2DS25680CT-5T	-	
512MB	elixir	M2U51264DS8HC1G-5T	-	DS	N2DS25680CT-5T	-	
256MB	Kreton	-	VT	SS	VT3225804T-5	-	
512MB	Kreton	-	VT	DS	VT3225804T-5	-	
256MB	Veritech	VT400FMV/2561103	VT	SS	VT56DD32M8PC-5	3	
512MB	Veritech	VT400FMV/5121003	VT	DS	VT56DD32M8PC-5	3	
256MB	Pmi	MD44256VIT3208GMHA01	MOSEL	SS	V58C2256804SAT5B	2.5	
512MB	Pmi	MD44512VIT3208GATA03	MOSEL	DS	V58C2256804SAT5B	2.5	
256MB	ProMOS	V826632K24SCTG-D0	-	SS	V58C2256804SCT5B	2.5	
512MB	ProMOS	V826664K24SCTG-D0	-	DS	V58C2256804SCT5B	2.5	
256MB	Deutron	AL5D8C53T-5B1T	PSC	SS	A2S56D30CTP	2.5	
512MB	Deutron	AL6D8C53T-5B1T	PSC	DS	A2S56D30CTP	2.5	
256MB	GEIL	GL5123200DC	-	SS	GL3LC32G88TG-35	-	
512MB	GEIL	GL1GB3200DC	-	DS	GL3LC32G88TG-35	-	
256MB	GEIL	GLX2563200UP	-	SS	GL3LC32G88TG-5A	-	
256MB	GEIL	GD3200-512DC	-	SS	WLCSP Package	-	
256MB	crucial	BL3264Z402.8TG	Ballistix	SS	-	2	
512MB	crucial	BL6464Z402.16TG	Ballistix	DS	-	2	
256MB	Novax	96M425653CE-40TB6	CEON	SS	C2S56D30TP-5	2.5	
512MB	Novax	96M451253CE-40TB6	CEON	DS	C2S56D30TP-5	2.5	

### Legend:

- SS** - Single-sided
- DS** - Double-sided
- CL** - CAS Latency



Visit the ASUS website ([www.asus.com](http://www.asus.com)) for the latest DDR 400 Qualified Vendors List.

### 1.7.3 Installing a DIMM



Make sure to unplug the power supply before adding or removing DIMMs or other system components. Failure to do so may cause severe damage to both the motherboard and the components.

1. Unlock a DIMM socket by pressing the retaining clips outward.
2. Align a DIMM on the socket such that the notch on the DIMM matches the break on the socket.

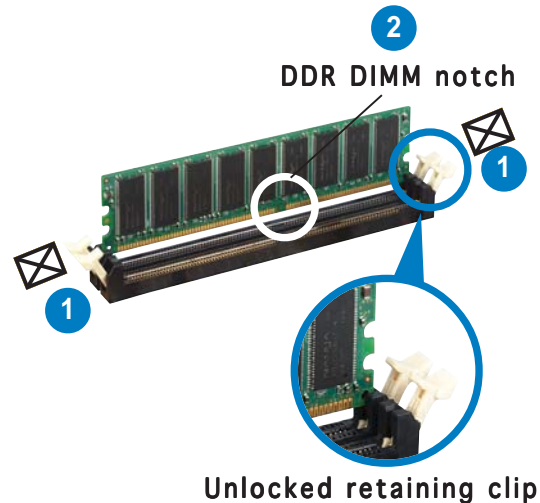

A DDR DIMM is keyed with a notch so that it fits in only one direction. DO NOT force a DIMM into a socket to avoid damaging the DIMM.

3. Firmly insert the DIMM into the socket until the retaining clips snap back in place and the DIMM is properly seated.

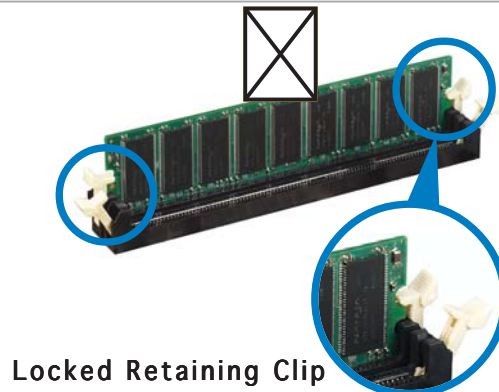

### 1.7.4 Removing a DIMM

Follow these steps to remove a DIMM.

1. Simultaneously press the retaining clips outward to unlock the DIMM.

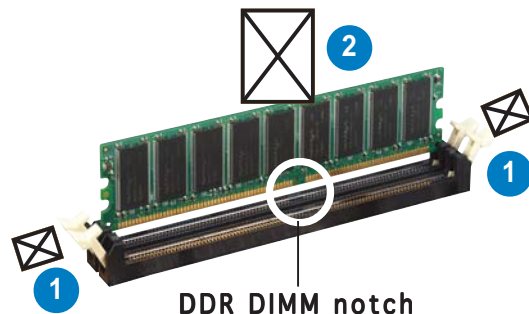

Support the DIMM lightly with your fingers when pressing the retaining clips. The DIMM might get damaged when it flips out with extra force.

2. Remove the DIMM from the socket.



## 1.8 Expansion slots

In the future, you may need to install expansion cards. The following sub-sections describe the slots and the expansion cards that they support.



---

Make sure to unplug the power cord before adding or removing expansion cards. Failure to do so may cause you physical injury and damage motherboard components.

---



---

We recommended to install the memory modules first before installing a PCI Express x16 card.

---

### 1.8.1 Installing an expansion card

To install an expansion card:

1. Before installing the expansion card, read the documentation that came with it and make the necessary hardware settings for the card.
2. Remove the system unit cover (if your motherboard is already installed in a chassis).
3. Remove the bracket opposite the slot that you intend to use. Keep the screw for later use.
4. Align the card connector with the slot and press firmly until the card is completely seated on the slot.
5. Secure the card to the chassis with the screw you removed earlier.
6. Replace the system cover.

### 1.8.2 Configuring an expansion card

After installing the expansion card, configure the it by adjusting the software settings.

1. Turn on the system and change the necessary BIOS settings, if any. See Chapter 2 for information on BIOS setup.
2. Assign an IRQ to the card. Refer to the tables on the next page.
3. Install the software drivers for the expansion card.



## 1.8.3 Interrupt assignments

### Standard interrupt assignments

IRQ	Priority	Standard Function
0	1	System Timer
1	2	Keyboard Controller
2	-	Re-direct to IRQ#9
4	12	Communications Port (COM1)*
5	13	IRQ holder for PCI steering*
6	14	Floppy Disk Controller
7	15	Printer Port (LPT1)*
8	3	System CMOS/Real Time Clock
9	4	IRQ holder for PCI steering*
10	5	IRQ holder for PCI steering*
11	6	IRQ holder for PCI steering*
12	7	PS/2 Compatible Mouse Port*
13	8	Numeric Data Processor
14	9	Primary IDE Channel
15	10	Secondary IDE Channel

\* These IRQs are usually available for ISA or PCI devices.

### IRQ assignments for this motherboard

	A	B	C	D	E	F	G	H
PCI slot 1	shared	—	—	—	—	—	—	—
PCI slot 2	—	shared	—	—	—	—	—	—
PCI slot 3	—	—	shared	—	—	—	—	—
Onboard USB 2.0 controller	shared	—	—	—	—	—	—	—
Onboard LAN1	shared	—	—	—	—	—	—	—



When using PCI cards on shared slots, ensure that the drivers support “Share IRQ” or that the cards do not need IRQ assignments. Otherwise, conflicts will arise between the two PCI groups, making the system unstable and the card inoperable.

## 1.8.4 PCI slots

The PCI slots support cards such as a LAN card, SCSI card, USB card, and other cards that comply with PCI specifications. The figure shows a LAN card installed on a PCI slot.

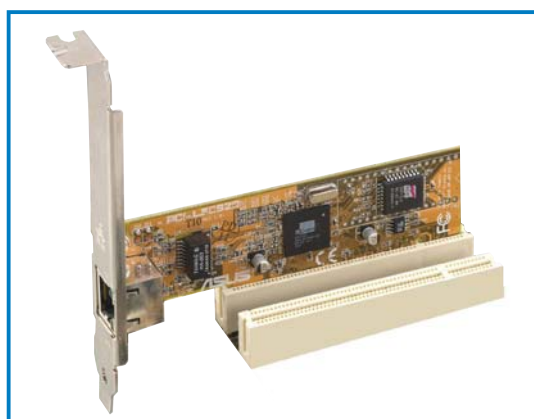

## 1.8.5 PCI Express x16 slot

This motherboard supports PCI Express x16 graphic cards that comply with the PCI Express specifications. The following figure shows a graphics card installed on the PCI Express x16 slot.

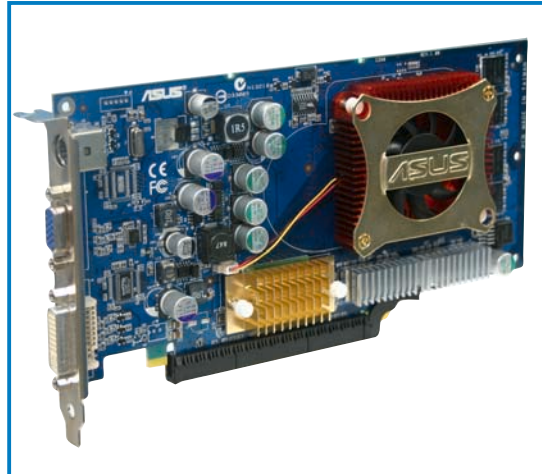

---

In Normal mode, only the PCI Express blue slot can be used for PCI Express x16 graphics cards. The PCI Express black slot functions as a PCI Express x1 slot.

---

## 1.8.6 PCI Express x1 slot

This motherboard supports PCI Express x1 network cards, SCSI cards and other cards that comply with the PCI Express specifications. The figure shows a network card installed on the PCI Express x1 slot.

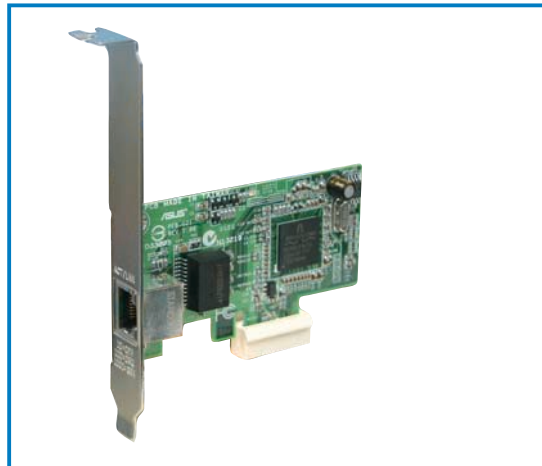

## 1.9 Jumpers

### 1. Clear RTC RAM (CLRTC)

This jumper allows you to clear the Real Time Clock (RTC) RAM in CMOS. You can clear the CMOS memory of date, time, and system setup parameters by erasing the CMOS RTC RAM data. The onboard button cell battery powers the RAM data in CMOS, which include system setup information such as system passwords.

To erase the RTC RAM:

1. Turn OFF the computer and unplug the power cord.
2. Remove the onboard battery.
3. Move the jumper cap from pins 1-2 (default) to pins 2-3. Keep the cap on pins 2-3 for about 5~10 seconds, then move the cap back to pins 1-2.
4. Re-install the battery.
5. Plug the power cord and turn ON the computer.
6. Hold down the <Del> key during the boot process and enter BIOS setup to re-enter data.



Except when clearing the RTC RAM, never remove the cap on CLRTC jumper default position. Removing the cap will cause system boot failure!

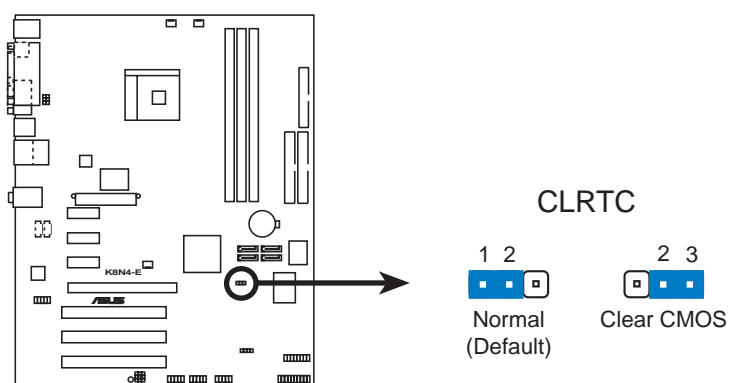

**K8N4-E Clear RTC RAM**



You do not need to clear the RTC when the system hangs due to overclocking. For system failure due to overclocking, use the C.P.R. (CPU Parameter Recall) feature. Shut down and reboot the system so the BIOS can automatically reset parameter settings to default values.

## 2. USB device wake-up (3-pin USBPW12, USBPW34, USBPW56, USBPW78, USBPW910)

Set these jumpers to +5V to wake up the computer from S1 sleep mode (CPU stopped, DRAM refreshed, system running in low power mode) using the connected USB devices. Set to +5VSB to wake up from S3 and S4 sleep modes (no power to CPU, DRAM in slow refresh, power supply in reduced power mode).

The USBPW12 and USBPW34 jumpers are for the rear USB ports. The USBPW56, USBPW78, and USBPW910 jumpers are for the internal USB connectors that you can connect to additional USB ports.

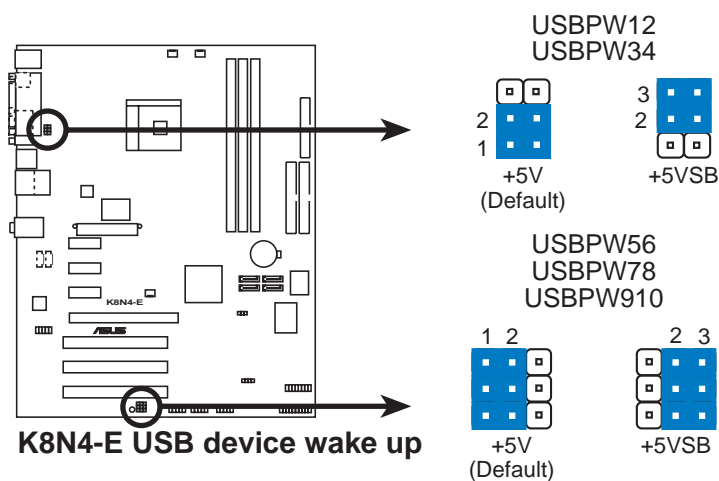

- The USB device wake-up feature requires a power supply that can provide 500mA on the +5VSB lead for each USB port; otherwise, the system would not power up.
- The total current consumed must NOT exceed the power supply capability (+5VSB) whether under normal condition or in sleep mode.

## 1.10 Connectors

### 1.10.1 Rear panel connectors

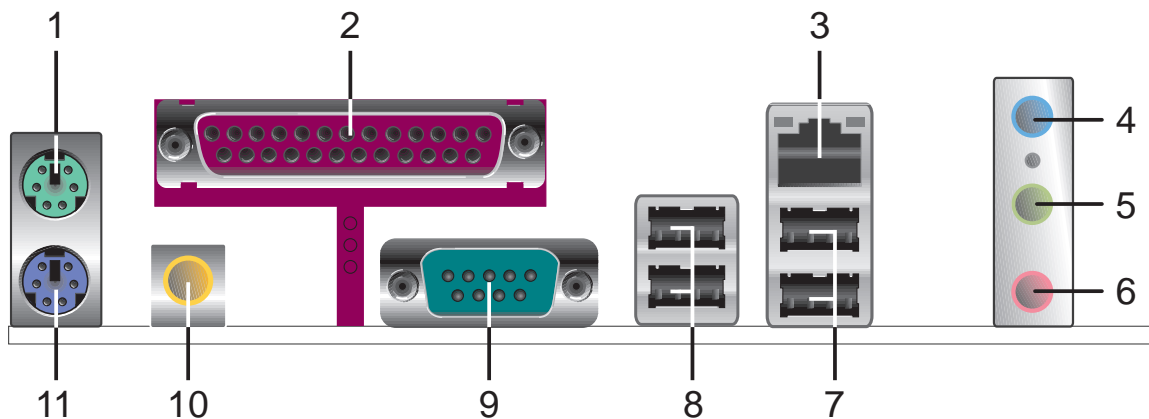

1. **PS/2 mouse port (green).** This port is for a PS/2 mouse.
2. **Parallel port.** This 25-pin port connects a parallel printer, a scanner, or other devices.
3. **LAN (RJ-45) port.** Supported by the NVIDIA® nForce™ 4 Gigabit MAC with external Marvell® PHY, this port allows Gigabit connection to a Local Area Network (LAN) through a network hub. Refer to the table below for the LAN port LED indications.

#### LAN port LED indications

ACT/LINK LED		SPEED LED	
Status	Description	Status	Description
OFF	No link	OFF	10 Mbps connection
GREEN	Linked	ORANGE	100 Mbps connection
BLINKING	Data activity	GREEN	1 Gbps connection

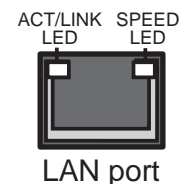

4. **Line In port (light blue).** This port connects the tape, CD, DVD player, or other audio sources.
5. **Line Out port (lime).** This port connects a headphone or a speaker. In 4-channel, 6-channel, and 8-channel configuration, the function of this port becomes Front Speaker Out.
6. **Microphone port (pink).** This port connects a microphone.



Refer to the audio configuration table on the next page for the function of the audio ports in 2, 4, or 6-channel configuration.

## Audio 2, 4, or 6-channel configuration

Port	Headset 2-channel	4-channel	6-channel
Light Blue	Line In	Rear Speaker Out	Rear Speaker Out
Lime	Line Out	Front Speaker Out	Front Speaker Out
Pink	Mic In	Mic In	Bass/Center Speaker

- 7. USB 2.0 ports 3 and 4.** These two 4-pin Universal Serial Bus (USB) ports are available for connecting USB 2.0 devices.
- 8. USB 2.0 ports 1 and 2.** These two 4-pin Universal Serial Bus (USB) ports are available for connecting USB 2.0 devices.
- 9. Serial port.** This 9-pin COM1 port is for pointing devices or other serial devices.
- 10. Coaxial S/PDIF Out port.** This port connects an external audio output device via an coaxial S/PDIF cable.
- 11. PS/2 keyboard port (purple).** This port is for a PS/2 keyboard.

### 1.10.2 Internal connectors

#### 1. Floppy disk drive connector (34-1 pin FLOPPY)

This connector is for the provided floppy disk drive (FDD) signal cable. Insert one end of the cable to this connector, then connect the other end to the signal connector at the back of the floppy disk drive.



The Pin 5 on the connector is removed to prevent incorrect cable connection when using an FDD cable with a covered Pin 5.

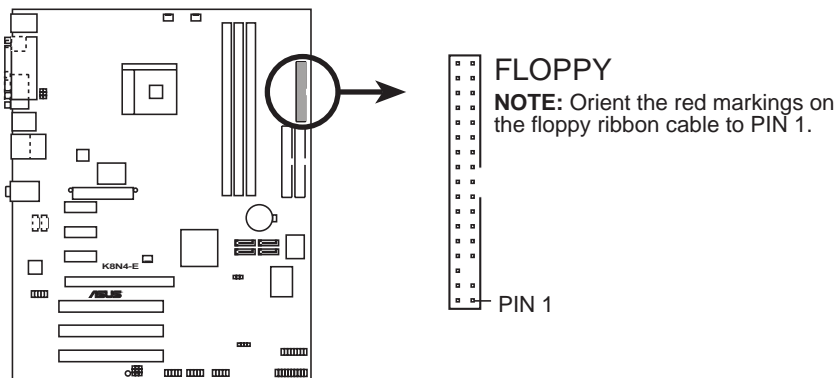

**K8N4-E Floppy disk drive connector**

## 2. IDE connectors (40-1 pin PRI\_IDE, SEC\_IDE)

These connectors are for Ultra DMA 133/100/66 signal cables. The Ultra DMA 133/100/66 signal cable has three connectors: a blue connector for the primary IDE connector on the motherboard, a black connector for an Ultra DMA 133/100/66 IDE slave device (optical drive/hard disk drive), and a gray connector for an Ultra DMA 133/100/66 IDE master device (hard disk drive). If you install two hard disk drives, you must configure the second drive as a slave device by setting its jumper accordingly. Refer to the hard disk documentation for the jumper settings.



- The Pin 20 on the IDE connector is removed to match the covered hole on the Ultra DMA cable connector. This prevents incorrect insertion when you connect the IDE cable.
- Use the 80-conductor IDE cable for UltraDMA133/100/66 IDE devices.

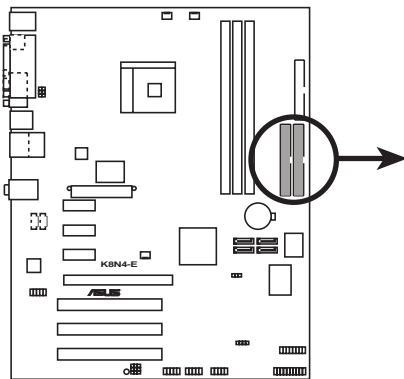

**K8N4-E IDE connectors**

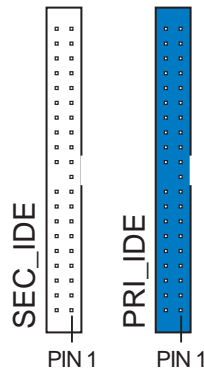

**NOTE:** Orient the red markings (usually zigzag) on the IDE ribbon cable to PIN 1.

### 3. Serial ATA connectors (7-pin SATA1 [black], SATA2 [black], SATA3 [black], SATA4 [black])

Supported by the NVIDIA® nForce4-4X chipset, these connectors are for the Serial ATA signal cables for Serial ATA hard disk drives that allow up to 3Gb/s of data transfer rate.

If you installed Serial ATA hard disk drives, you can create RAID 0, RAID 1, RAID 1+0, or JBOD configuration that spans across the Parallel ATA drives. Refer to Chapter 5 for details on how to set up RAID configurations.



These connectors are set to **SATA** by default. In SATA mode, you can connect Serial ATA boot or data hard disk drives to these connectors. If you intend to create a Serial ATA RAID set using these connectors, enable the **RAID** function of each port from the **NVRAID configuration** sub-item in the BIOS. See section “4.4.3 Onboard device configuration” for details.

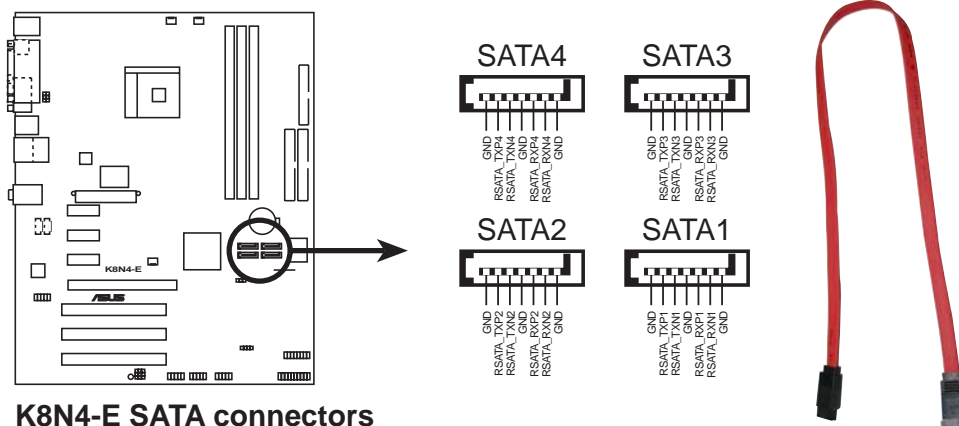

**K8N4-E SATA connectors**



#### Important notes on Serial ATA

- The actual data transfer rate depends on the speed of Serial ATA hard disks installed.
- See the Appendix for instructions on how to install the Serial ATA extension module.



#### 4. CPU, Chassis and Power fan connectors (3-pin CPU\_FAN, CHA2\_FAN, PWR\_FAN, CHIP\_FAN)

The fan connectors support cooling fans of 350 mA ~ 2000 mA (24 W max.) or a total of 1 A ~ 3.48 A (41.76 W max.) at +12 V. Connect the fan cables to the fan connectors on the motherboard, making sure that the black wire of each cable matches the ground pin of the connector.



Do not forget to connect the fan cables to the fan connectors. Insufficient air flow inside the system may damage the motherboard components. These are not jumpers! DO NOT place jumper caps on the fan connectors.

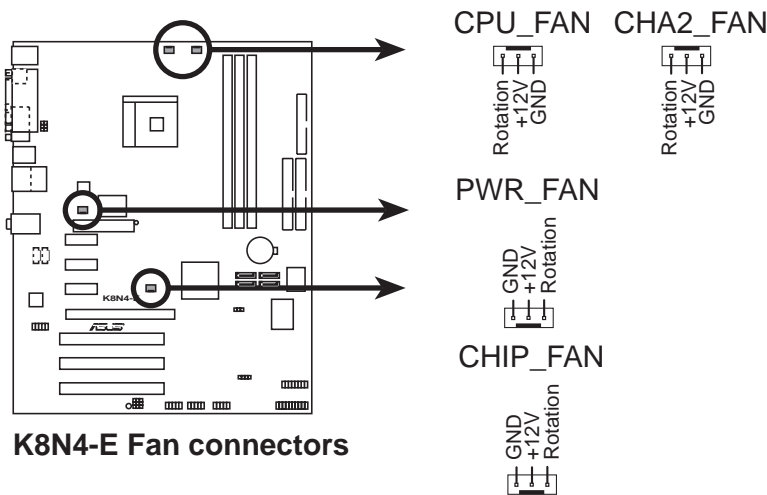

## 5. USB connectors (10-1 pin USB56, USB78, USB910)

These connectors are for USB 2.0 ports. Connect the USB/GAME module cable to any of these connectors, then install the module to a slot opening at the back of the system chassis. These USB connectors comply with USB 2.0 specification that supports up to 480 Mbps connection speed.

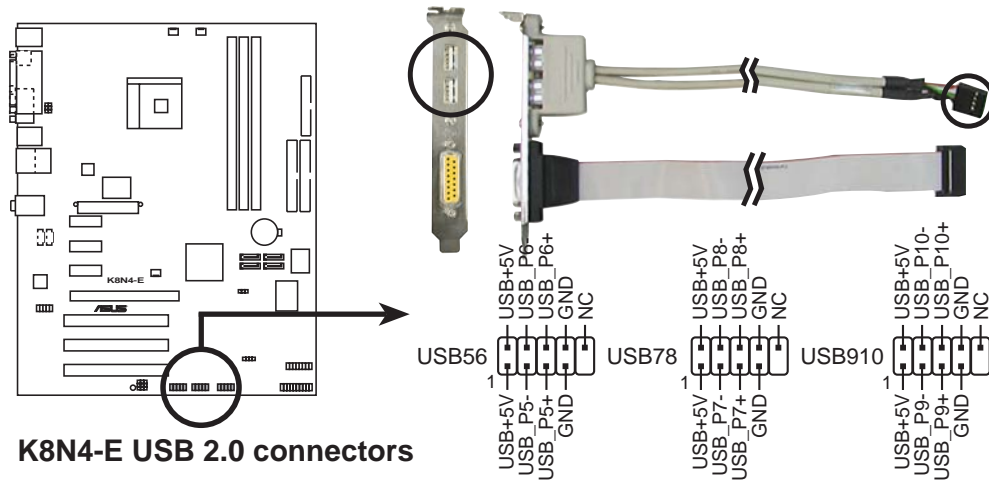

Never connect a **1394** cable to the USB connectors. Doing so will damage the motherboard!

## 6. ATX power connectors (24-pin EATXPWR, 4-pin ATX12V)

These connectors are for an ATX power supply. The plugs from the power supply are designed to fit these connectors in only one orientation. Find the proper orientation and push down firmly until the connectors completely fit.



- We recommend that you use an ATX 12 V Specification 2.0-compliant power supply unit (PSU) with a minimum of 350 W power rating. This PSU type has 24-pin and 4-pin power plugs.
- If you intend to use a PSU with 20-pin and 4-pin power plugs, make sure that the 20-pin power plug can provide at least 15A on +12V and that the PSU has a minimum power rating of 350 W. The system may become unstable or may not boot up if the power is inadequate.
- Do not forget to connect the 4-pin ATX +12 V power plug; otherwise, the system will not boot up.
- We recommend that you use a PSU with higher power output when configuring a system with more power-consuming devices. The system may become unstable or may not boot up if the power is inadequate.
- You must install a PSU with a higher power rating if you intend to install additional devices.

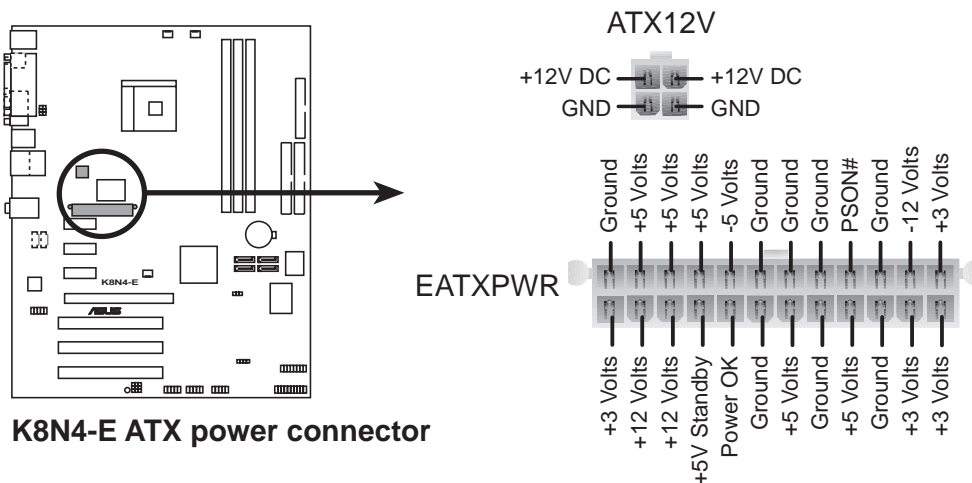

## 9. Internal audio connectors (4-pin CD, AUX)

These connectors allow you to receive stereo audio input from sound sources such as a CD-ROM, TV-tuner, or MPEG card.

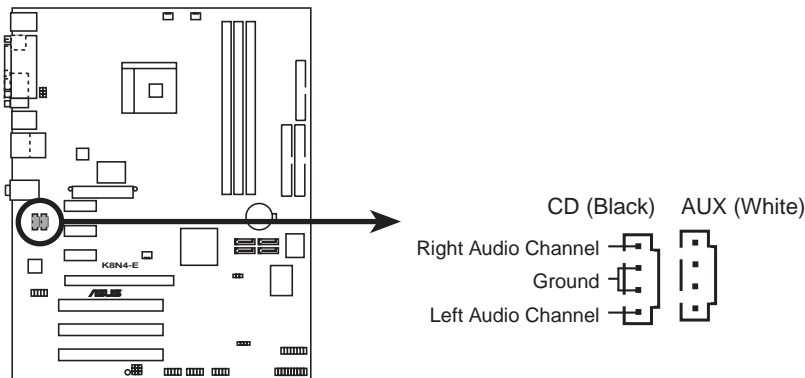

**K8N4-E Internal audio connectors**



The function of these connectors are disabled under 8-channel mode.

## 10. GAME/MIDI port connector (16-1 pin GAME)

This connector is for a GAME/MIDI port. Connect the USB/GAME module cable to this connector, then install the module to a slot opening at the back of the system chassis. The GAME/MIDI port connects a joystick or game pad for playing games, and MIDI devices for playing or editing audio files.

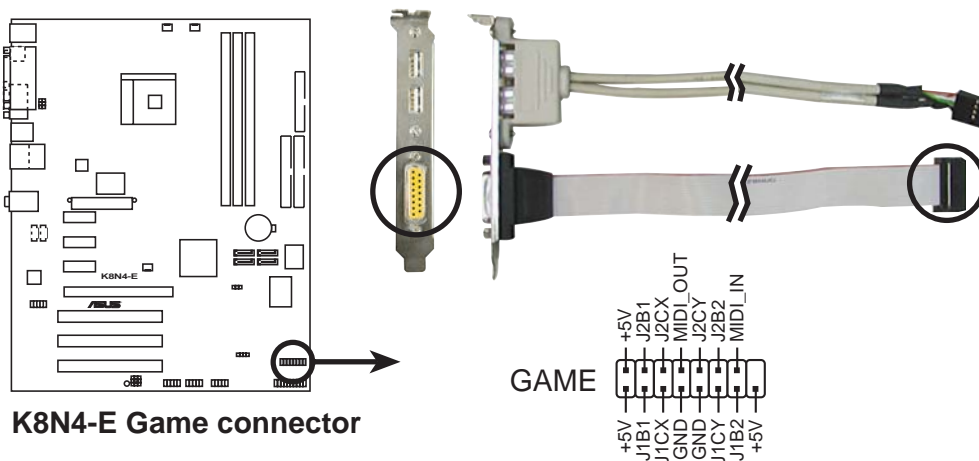

**K8N4-E Game connector**

## 11. Chassis intrusion connector (4-1 pin CHASSIS)

This connector is for a chassis-mounted intrusion detection sensor or switch. Connect one end of the chassis intrusion sensor or switch cable to this connector. The chassis intrusion sensor or switch sends a high-level signal to this connector when a chassis component is removed or replaced. The signal is then generated as a chassis intrusion event.

By default, the pins labeled “Chassis Signal” and “Ground” are shorted with a jumper cap. Remove the jumper caps only when you intend to use the chassis intrusion detection feature.

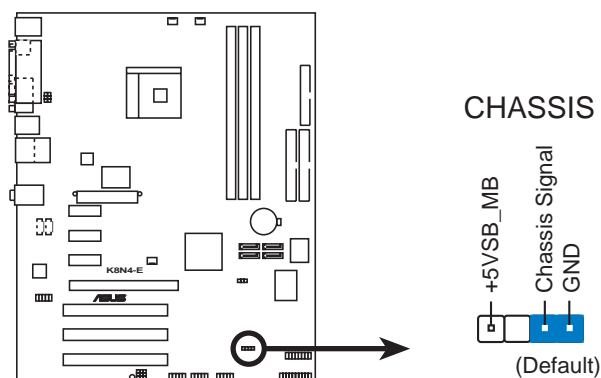

**K8N4-E Chassis intrusion connector**

## 12. Front panel audio connector (10-1 pin FP\_AUDIO)

This connector is for a chassis-mounted front panel audio I/O module that supports legacy AC '97 audio standard. Connect one end of the front panel audio I/O module cable to this connector.

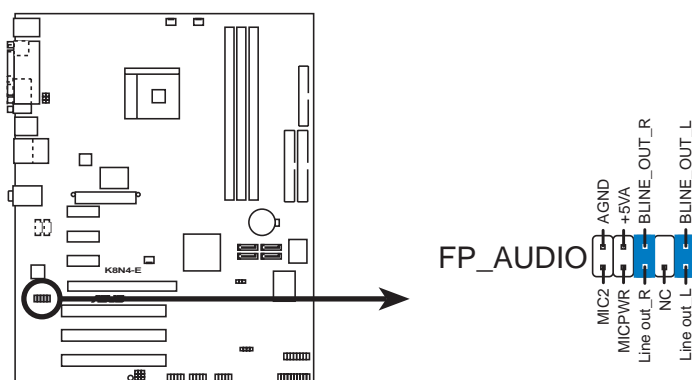

**K8N4-E Front panel audio connector**

### 13. System panel connector (20-pin PANEL)

This connector supports several chassis-mounted functions.

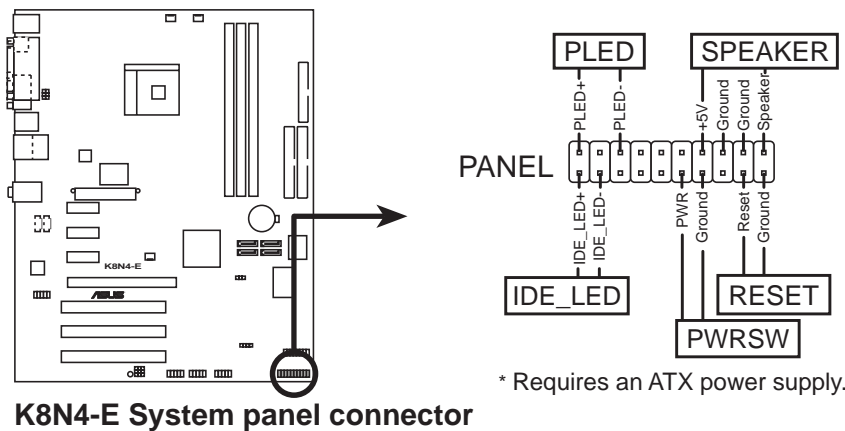

The system panel connector is color-coded for easy connection. Refer to the connector description below for details.

- **System power LED (Green 3-pin PLED)**  
This 3-pin connector is for the system power LED. Connect the chassis power LED cable to this connector. The system power LED lights up when you turn on the system power, and blinks when the system is in sleep mode.
- **Hard disk drive activity (Red 2-pin IDE\_LED)**  
This 2-pin connector is for the HDD Activity LED. Connect the HDD Activity LED cable to this connector. The IDE LED lights up or flashes when data is read from or written to the HDD.
- **System warning speaker (Orange 4-pin SPEAKER)**  
This 4-pin connector is for the chassis-mounted system warning speaker. The speaker allows you to hear system beeps and warnings.
- **Power/Soft-off button (Lime 2-pin PWRSW)**  
This connector is for the system power button. Pressing the power button turns the system ON or puts the system in SLEEP or SOFT-OFF mode depending on the BIOS settings. Pressing the power switch for more than four seconds while the system is ON turns the system OFF.
- **Reset button (Blue 2-pin RESET)**  
This 2-pin connector is for the chassis-mounted reset button for system reboot without turning off the system power.

This chapter tells how to change the system settings through the BIOS Setup menus. Detailed descriptions of the BIOS parameters are also provided.

# BIOS setup

## 2.1 Managing and updating your BIOS

The following utilities allow you to manage and update the motherboard Basic Input/Output System (BIOS) setup.

1. **Award BIOS Flash Utility** (Updates the BIOS in DOS mode using a bootable floppy disk.)
2. **ASUS CrashFree BIOS 2** (Updates the BIOS using a bootable floppy disk or the motherboard support CD when the BIOS file fails or gets corrupted.)
3. **ASUS EZ Flash** (Updates the BIOS in DOS using a floppy disk or the motherboard support CD.)
4. **ASUS Update** (Updates the BIOS in Windows® environment.)

Refer to the corresponding sections for details on these utilities.



---

Save a copy of the original motherboard BIOS file to a bootable floppy disk in case you need to restore the BIOS in the future. Copy the original motherboard BIOS using the ASUS Update or AwardBIOS Flash utilities.

---

### 2.1.1 Creating a bootable floppy disk

1. Do either one of the following to create a bootable floppy disk.

#### DOS environment

- a. Insert a 1.44MB floppy disk into the drive.
- b. At the DOS prompt, type `format A:/S` then press <Enter>.

#### Windows® XP environment

- a. Insert a 1.44 MB floppy disk to the floppy disk drive.
- b. Click **Start** from the Windows® desktop, then select **My Computer**.
- c. Select the 3 1/2 Floppy Drive icon.
- d. Click **File** from the menu, then select **Format**. A **Format 3 1/2 Floppy Disk** window appears.
- e. Select **Create an MS-DOS startup disk** from the format options field, then click **Start**.

#### Windows® 2000 environment

To create a set of boot disks for Windows® 2000:

- a. Insert a formatted, high density 1.44 MB floppy disk into the drive.
- b. Insert the Windows® 2000 CD to the optical drive.



- c. Click **Start**, then select **Run**.
  - d. From the Open field, type  
`D:\bootdisk\makeboot a:`  
assuming that D: is your optical drive.
  - e. Press <Enter>, then follow screen instructions to continue.
2. Copy the original or the latest motherboard BIOS file to the bootable floppy disk.

## 2.1.2 Updating the BIOS

The Basic Input/Output System (BIOS) can be updated using the AwardBIOS Flash Utility. Follow these instructions to update the BIOS using this utility.

1. Download the latest BIOS file from the ASUS web site. Rename the file to **K8N4-EB.BIN** and save it to a floppy disk.



---

Save only the updated BIOS file in the floppy disk to avoid loading the wrong BIOS file.

---

2. Copy the AwardBIOS Flash Utility (awdfash.exe) from the Software folder of the support CD to the floppy disk with the latest BIOS file.
3. Boot the system in DOS mode using the bootable floppy disk you created earlier.
4. When the **A:>** appears, replace the bootable floppy disk with the floppy disk containing the new BIOS file and the Award BIOS Flash Utility.
5. At the prompt, type **awdfash** then press <Enter>. The Award BIOS Flash Utility screen appears.

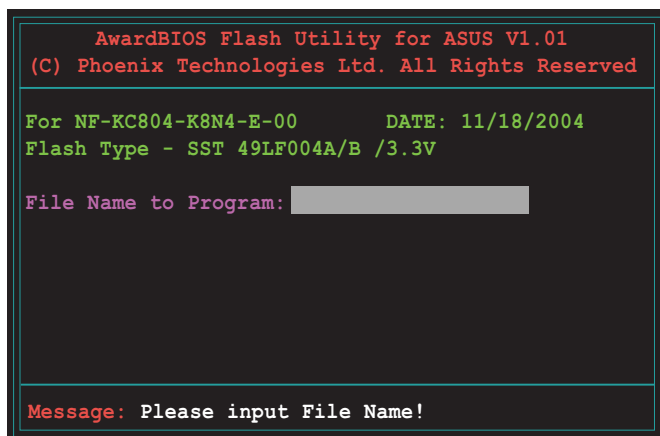

```
AwardBIOS Flash Utility for ASUS V1.01
(C) Phoenix Technologies Ltd. All Rights Reserved

For NF-KC804-K8N4-E-00      DATE: 11/18/2004
Flash Type - SST 49LF004A/B /3.3V

File Name to Program: 

Message: Please input File Name!
```

- Type the BIOS file name in the **File Name to Program** field, then press <Enter>.

```

AwardBIOS Flash Utility for ASUS V1.01
(C) Phoenix Technologies Ltd. All Rights Reserved

For NF-KC804-K8N4-E-00    DATE: 11/18/2004
Flash Type - SST 49LF004A/B /3.3V

File Name to Program: 1001.bin

Message: Do You Want To Save Bios (Y/N)

```

- Press <N> when the utility prompts you to save the current BIOS file. The following screen appears.
- The utility verifies the BIOS file in the floppy disk and starts flashing the BIOS file.

```

AwardBIOS Flash Utility for ASUS V1.01
(C) Phoenix Technologies Ltd. All Rights Reserved

For NF-KC804-K8N4-E-00    DATE: 11/18/2004
Flash Type - SST 49LF004A/B /3.3V

File Name to Program: 1001.bin

Program Flashing Memory - OFE00 OK
[Progress Bar]

[ ] Write OK   [ ] No Update   [ ] Write Fail

Warning: Don't Turn Off Power Or Reset System!

```



---

Do not turn off or reset the system during the flashing process!

---

- The utility displays a **Flashing Complete** message indicating that you have successfully flashed the BIOS file. Remove the floppy disk then press <F1> to restart the system.

```

AwardBIOS Flash Utility for ASUS V1.01
(C) Phoenix Technologies Ltd. All Rights Reserved

For NF-KC804-K8N4-E-00    DATE: 11/18/2004
Flash Type - SST 49LF004A/B /3.3V

File Name to Program: 1001.bin
Flashing Complete
Press <F1> to Continue

[Progress Bar]

[ ] Write OK   [ ] No Update   [ ] Write Fail

F1 Reset

```

## 2.1.3 Saving the current BIOS file

You can use the AwardBIOS Flash Utility to save the current BIOS file. You can load the current BIOS file when the BIOS file gets corrupted during the flashing process.



Make sure that the floppy disk has enough disk space to save the file.

To save the current BIOS file using the AwardBIOS Flash Utility:

1. Follow steps 1 to 6 of the previous section.
2. Press <Y> when the utility prompts you to save the current BIOS file. The following screen appears.

```
AwardBIOS Flash Utility for ASUS V1.01
(C) Phoenix Technologies Ltd. All Rights Reserved

For NF-KC804-K8N4-E-00      DATE: 11/18/2004
Flash Type - SST 49LF004A/B /3.3V

File Name to Program: 1001.bin
Save current BIOS as:

Message:
```

3. Type a filename for the current BIOS file in the **Save current BIOS as** field, then press <Enter>.

```
AwardBIOS Flash Utility for ASUS V1.01
(C) Phoenix Technologies Ltd. All Rights Reserved

For NF-KC804-K8N4-E-00      DATE: 11/18/2004
Flash Type - SST 49LF004A/B /3.3V

File Name to Program: 1001.bin
Checksum: DAD6H
Save current BIOS as: old.bin

Message: Please Wait!
```

4. The utility saves the current BIOS file to the floppy disk, then returns to the BIOS flashing process.

```
AwardBIOS Flash Utility for ASUS V1.01
(C) Phoenix Technologies Ltd. All Rights Reserved

For NF-KC804-K8N4-E-00      DATE: 11/18/2004
Flash Type - SST 49LF004A/B /3.3V

File Name to Program: 1001.bin
Now Backup System BIOS to
File!
Message: Please Wait!
```

## 2.1.4 ASUS CrashFree BIOS 2 utility

The ASUS CrashFree BIOS 2 is an auto recovery tool that allows you to restore the BIOS file when it fails or gets corrupted during the updating process. You can update a corrupted BIOS file using the motherboard support CD or the floppy disk that contains the updated BIOS file.



---

Prepare the motherboard support CD or the floppy disk containing the updated motherboard BIOS before using this utility.

---

### Recovering the BIOS from the support CD

To recover the BIOS from the support CD:

1. Turn on the system.
2. Insert the motherboard support CD to the optical drive.
3. The utility displays the following message and automatically checks the CD for the BIOS file.

```
Award BootBlock BIOS v1.0
Copyright (c) 2000, Award Software, Inc.

BIOS ROM checksum error
Detecting IDE ATAPI device...
```

When found, the utility reads the BIOS file and starts flashing the corrupted BIOS file.

```
Award BootBlock BIOS v1.0
Copyright (c) 2000, Award Software, Inc.

BIOS ROM checksum error
Detecting IDE ATAPI device...
Found CDROM, try to Boot from it... Pass
```



---

DO NOT shut down or reset the system while updating the BIOS! Doing so can cause system boot failure!

---

4. Restart the system after the utility completes the updating process.

## Recovering the BIOS from a floppy disk

To recover the BIOS from the support CD:

1. Remove any CD from the optical drive, then turn on the system.
2. Insert the floppy disk with the original or updated BIOS file to the floppy disk drive.
3. The utility displays the following message and automatically checks the floppy disk for the original or updated BIOS file.

```
Award BootBlock BIOS v1.0
Copyright (c) 2000, Award Software, Inc.

BIOS ROM checksum error
Detecting IDE ATAPI device...
```

When no CD is found, the utility automatically checks the floppy drive for the original or updated BIOS file. The utility then updates the corrupted BIOS file.

```
Award BootBlock BIOS v1.0
Copyright (c) 2000, Award Software, Inc.

BIOS ROM checksum error
Detecting IDE ATAPI device...
  Found CDRom, try to Boot from it... Fail

Detecting floppy drive A media...
```



---

DO NOT shut down or reset the system while updating the BIOS! Doing so can cause system boot failure!

---

4. Restart the system after the utility completes the updating process.



---

The recovered BIOS may not be the latest BIOS version for this motherboard. Visit the ASUS website ([www.asus.com](http://www.asus.com)) to download the latest BIOS file.

---

## 2.1.5 ASUS EZ Flash utility

The ASUS EZ Flash feature allows you to update the BIOS without having to go through the long process of booting from a floppy disk and using a DOS-based utility. The EZ Flash utility is built-in the BIOS chip so it is accessible by pressing <Alt> + <F2> during the Power-On Self Tests (POST).

To update the BIOS using EZ Flash:

1. Visit the ASUS website ([www.asus.com](http://www.asus.com)) to download the latest BIOS file for the motherboard.
2. Save the BIOS file to a floppy disk, then restart the system.
3. Press <Alt> + <F2> during POST to display the following.

```
Insert Disk then press Enter or ESC to continue POST
```

4. Insert the floppy disk that contains the BIOS file to the floppy disk drive then press <Enter>. The following screen appears.

```
AwardBIOS Flash Utility for ASUS V1.01
(C) Phoenix Technologies Ltd. All Rights Reserved

For NF-KC804-K8N4-E-00      DATE: 11/18/2004
Flash Type - SST 49LF004A/B /3.3V

File Name to Program: 

Message: Please wait...
```

5. When the correct BIOS file is found, EZ Flash performs the BIOS update process and automatically reboots the system when done.



---

Do not shutdown or reset the system while updating the BIOS to prevent system boot failure!

---

## 2.1.6 ASUS Update utility

The ASUS Update is a utility that allows you to manage, save, and update the motherboard BIOS in Windows® environment. The ASUS Update utility allows you to:

- Save the current BIOS file
- Download the latest BIOS file from the Internet
- Update the BIOS from an updated BIOS file
- Update the BIOS directly from the Internet, and
- View the BIOS version information.

This utility is available in the support CD that comes with the motherboard package.



---

ASUS Update requires an Internet connection either through a network or an Internet Service Provider (ISP).

---

### Installing ASUS Update

To install ASUS Update:

1. Place the support CD in the optical drive. The **Drivers** menu appears.
2. Click the **Utilities** tab, then click **Install ASUS Update VX.XX.XX**. See page 3-3 for the **Utilities** screen menu.
3. The ASUS Update utility is copied to your system.



---

Quit all Windows® applications before you update the BIOS using this utility.

---

## Updating the BIOS through the Internet

To update the BIOS through the Internet:

1. Launch the ASUS Update utility from the Windows® desktop by clicking **Start > Programs > ASUS > ASUSUpdate > ASUSUpdate**. The ASUS Update main window appears.

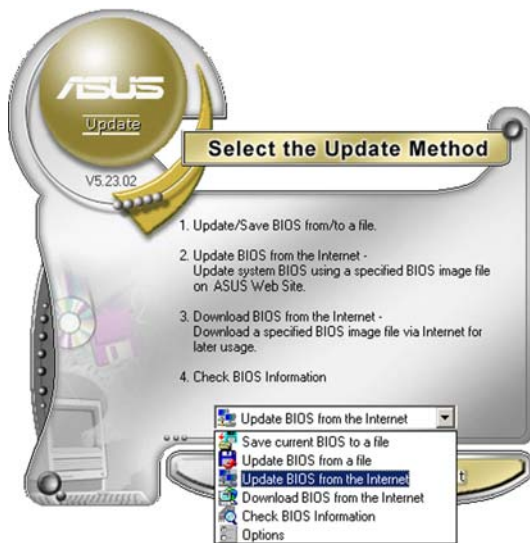
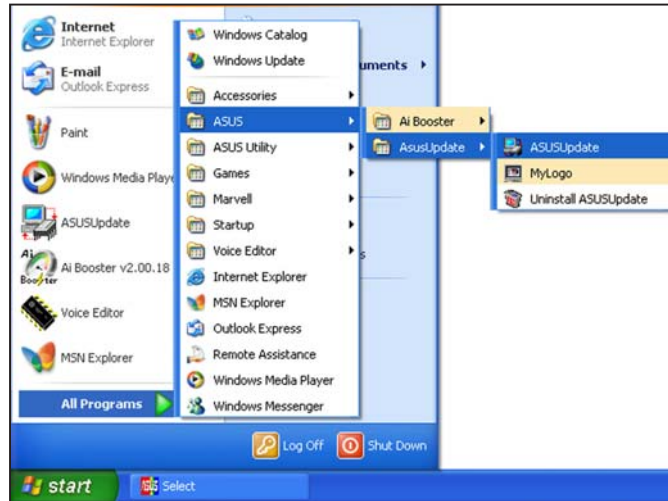

2. Select **Update BIOS from the Internet** option from the drop-down menu, then click **Next**.



3. Select the ASUS FTP site nearest you to avoid network traffic, or click **Auto Select**. Click **Next**.



- From the FTP site, select the BIOS version that you wish to download. Click Next.
- Follow the screen instructions to complete the update process.



The ASUS Update utility is capable of updating itself through the Internet. Always update the utility to avail all its features.



## Updating the BIOS through a BIOS file

To update the BIOS through a BIOS file:

- Launch the ASUS Update utility from the Windows® desktop by clicking **Start > Programs > ASUS > ASUSUpdate > ASUSUpdate**. The ASUS Update main window appears.
- Select **Update BIOS from a file** option from the drop-down menu, then click **Next**.

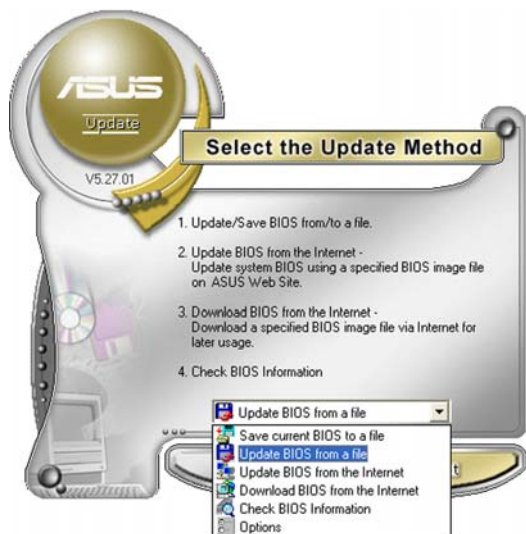

- Locate the BIOS file from the **Open** window, then click **Open**.
- Follow the screen instructions to complete the update process.

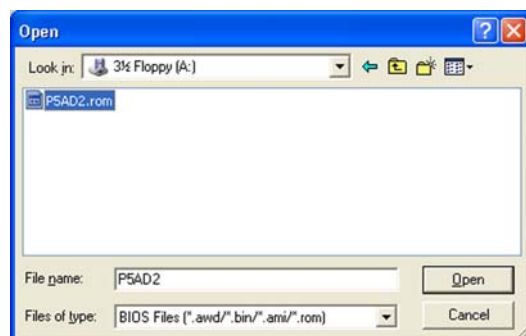

## 2.2 BIOS setup program

This motherboard supports a programmable Low-Pin Count (LPC) chip that you can update using the provided utility described in section “2.1 Managing and updating your BIOS.”

Use the BIOS Setup program when you are installing a motherboard, reconfiguring your system, or prompted to “Run Setup”. This section explains how to configure your system using this utility.

Even if you are not prompted to use the Setup program, you can change the configuration of your computer in the future. For example, you can enable the security password feature or change the power management settings. This requires you to reconfigure your system using the BIOS Setup program so that the computer can recognize these changes and record them in the CMOS RAM of the LPC chip.

The LPC chip on the motherboard stores the Setup utility. When you start up the computer, the system provides you with the opportunity to run this program. Press <Del> during the Power-On Self-Test (POST) to enter the Setup utility; otherwise, POST continues with its test routines.

If you wish to enter Setup after POST, restart the system by pressing <Ctrl+Alt+Delete>, or by pressing the reset button on the system chassis. You can also restart by turning the system off and then back on. Do this last option only if the first two failed.

The Setup program is designed to make it as easy to use as possible. Being a menu-driven program, it lets you scroll through the various sub-menus and make your selections from the available options using the navigation keys.



- 
- The default BIOS settings for this motherboard apply for most conditions to ensure optimum performance. If the system becomes unstable after changing any BIOS settings, load the default settings to ensure system compatibility and stability. Select the **Load Default Settings** item under the Exit Menu. See section “2.7 Exit Menu.”
  - The BIOS setup screens shown in this section are for reference purposes only, and may not exactly match what you see on your screen.
  - Visit the ASUS website ([www.asus.com](http://www.asus.com)) to download the latest BIOS file for this motherboard and .
-

## 2.2.1 BIOS menu screen

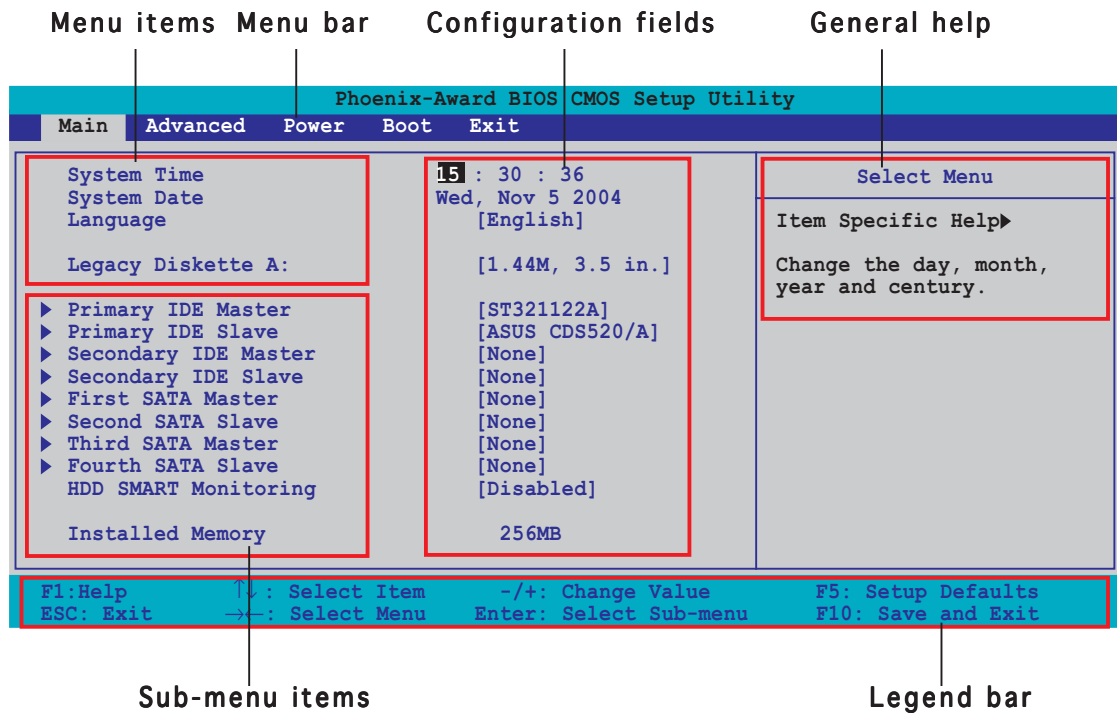

## 2.2.2 Menu bar

The menu bar on top of the screen has the following main items:

- Main** For changing the basic system configuration
- Advanced** For changing the advanced system settings
- Power** For changing the advanced power management (APM) configuration
- Boot** For changing the system boot configuration
- Exit** For selecting the exit options and loading default settings

To select an item on the menu bar, press the right or left arrow key on the keyboard until the desired item is highlighted.



- The BIOS setup screens shown in this chapter are for reference purposes only, and may not exactly match what you see on your screen.
- Visit the ASUS website ([www.asus.com](http://www.asus.com)) to download the latest BIOS information.

### 2.2.3 Legend bar

At the bottom of the Setup screen is a legend bar. The keys in the legend bar allow you to navigate through the various setup menus. The following table lists the keys found in the legend bar with their corresponding functions.

Navigation Key	Function
<F1>	Displays the General Help screen
<F5>	Loads setup default values
<Esc>	Exits the BIOS setup or returns to the main menu from a sub-menu
Left or Right arrow	Selects the menu item to the left or right
Up or Down arrow	Moves the highlight up or down between fields
Page Down or - (minus)	Scrolls backward through the values for the highlighted field
Page Up or + (plus)	Scrolls forward through the values for the highlighted field
<Enter>	Brings up a selection menu for the highlighted field
<F10>	Saves changes and exit

### 2.2.4 Menu items

The highlighted item on the menu bar displays the specific items for that menu. For example, selecting **Main** shows the Main menu items.

The other items (Advanced, Power, Boot, and Exit) on the menu bar have their respective menu items.

### 2.2.5 Sub-menu items

A solid triangle before each item on any menu screen means that the item has a sub-menu. To display the sub-menu, select the item and press <Enter>.

### 2.2.6 Configuration fields

These fields show the values for the menu items. If an item is user-configurable, you can change the value of the field opposite the item. You cannot select an item that is not user-configurable.

A configurable field is enclosed in brackets, and is highlighted when selected. To change the value of a field, select it then press <Enter> to display a list of options. Refer to “2.2.7 Pop-up window.”

## 2.2.7 Pop-up window

Select a menu item then press <Enter> to display a pop-up window with the configuration options for that item.

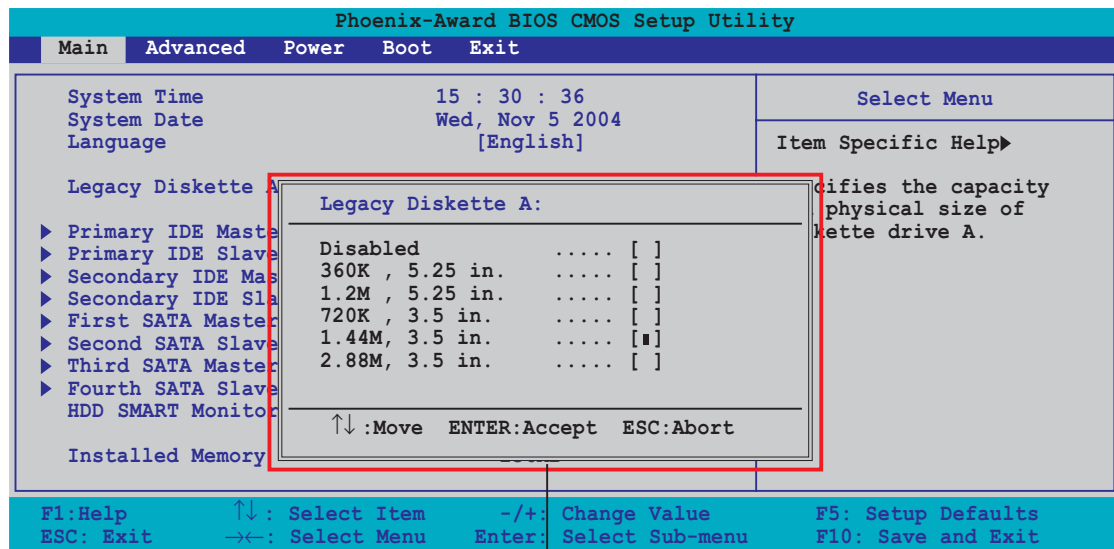

Pop-up menu

## 2.2.8 General help

At the top right corner of the menu screen is a brief description of the selected item.

## 2.3 Main menu

When you enter the BIOS Setup program, the Main menu screen appears, giving you an overview of the basic system information.



Refer to section “2.2.1 BIOS menu screen” for information on the menu screen items and how to navigate through them.

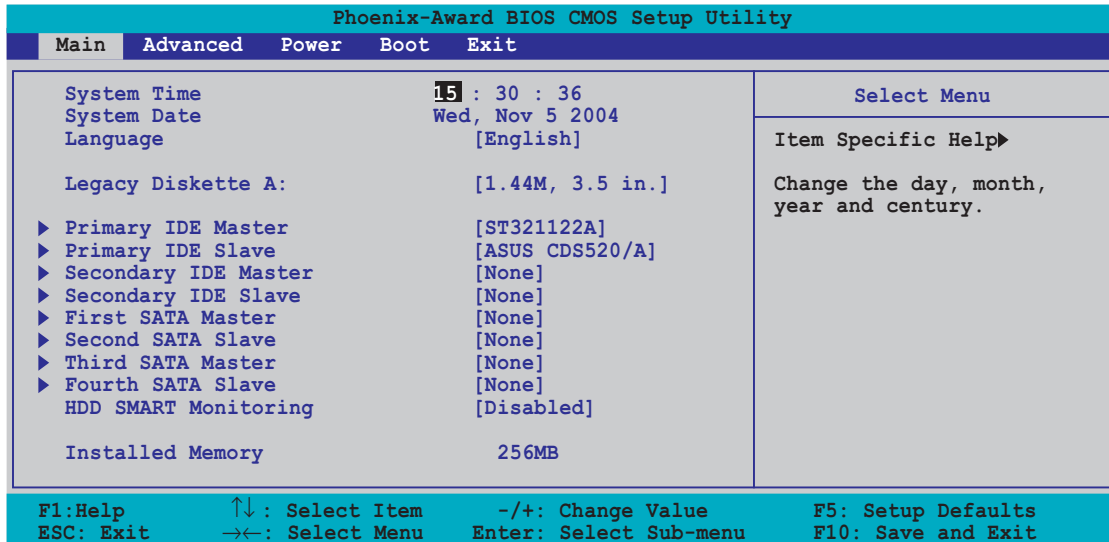

### 2.3.1 System Time [xx:xx:xxxx]

Allows you to set the system time.

### 2.3.2 System Date [Day xx/xx/xxxx]

Allows you to set the system date.

### 2.3.3 Language [English]

Allows you to choose the BIOS language version from the options.

Configuration options: [English] [French] [Deutsch]

### 2.3.4 Legacy Diskette A [1.44M, 3.5 in.]

Sets the type of floppy drive installed. Configuration options: [Disabled]

[360K, 5.25 in.] [1.2M, 5.25 in.] [720K, 3.5 in.] [1.44M, 3.5 in.]

[2.88M, 3.5 in.]

## 2.3.5 Primary and Secondary IDE Master/Slave

While entering Setup, the BIOS automatically detects the presence of IDE devices. There is a separate sub-menu for each IDE device. Select a device item then press <Enter> to display the IDE device information.

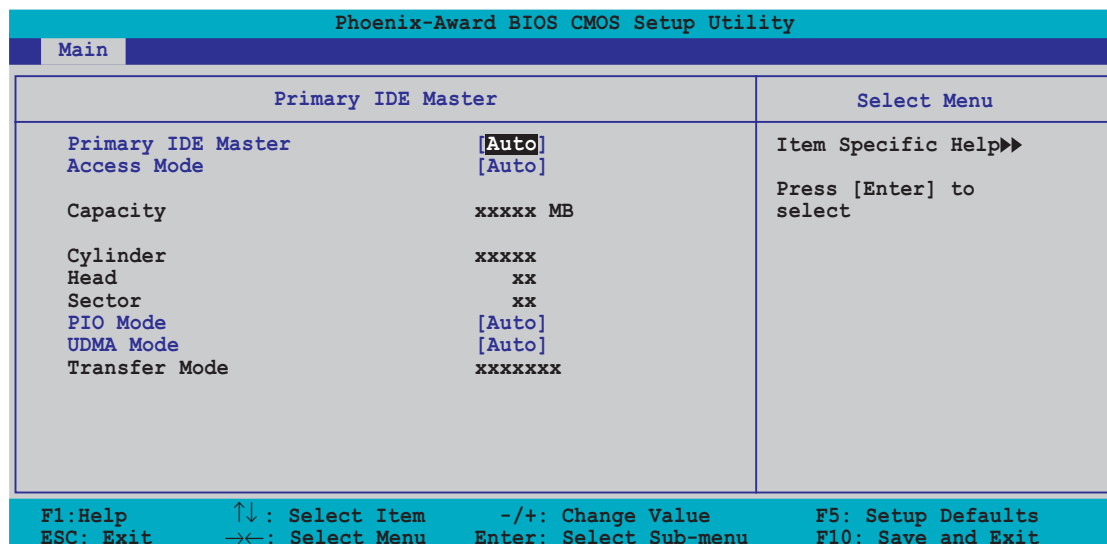

The BIOS automatically detects the values opposite the dimmed items (Capacity, Cylinder, Head, Sector and Transfer Mode). These values are not user-configurable. These items show N/A if no IDE device is installed in the system.

### Primary IDE Master/Slave [Auto]; Secondary IDE Master/Slave [Auto]

Select [Auto] to automatically detect an IDE hard disk drive. If automatic detection is successful, the BIOS automatically fills in the correct values for the remaining fields on this sub-menu. If the hard disk was already formatted on a previous system, the setup BIOS may detect incorrect parameters. Select [Manual] to manually enter the IDE hard disk drive parameters. If no drive is installed select [None].

Configuration options: [None] [Auto] [Manual]

### Access Mode [Auto]

The default [Auto] allows automatic detection of an IDE hard disk drive. Select [CHS] for this item if you set the IDE Primary Master/Slave to [Manual]. Configuration options: [CHS] [LBA] [Large] [Auto]



Before attempting to configure a hard disk drive, make sure you have the correct configuration information supplied by the drive manufacturer. Incorrect settings may cause the system to fail to recognize the installed hard disk.

## Capacity

Displays the auto-detected hard disk capacity. This item is not configurable.

## Cylinder

Shows the number of the hard disk cylinders. This item is not configurable.

## Head

Shows the number of the hard disk read/write heads. This item is not configurable.

## Sector

Shows the number of sectors per track. This item is not configurable.

## PIO Mode

Sets the PIO mode for the IDE device.

Configuration options: [Auto] [Mode 0] [Mode 1] [Mode 2] [Mode 3] [Mode 4]

## UDMA Mode

Disables or sets the UDMA mode. Configuration options: [Disabled] [Auto]

## Transfer Mode

Shows the Transfer mode. This item is not configurable.



---

After entering the IDE hard disk drive information into BIOS, use a disk utility, such as FDISK, to partition and format new IDE hard disk drives. This is necessary so that you can write or read data from the hard disk. Make sure to set the partition of the Primary IDE hard disk drives to active.

---



## 2.3.6 First, Second, Third, Fourth SATA Master

While entering Setup, the BIOS automatically detects the presence of Serial ATA devices. There is a separate sub-menu for each SATA device. Select a device item then press <Enter> to display the SATA device information.

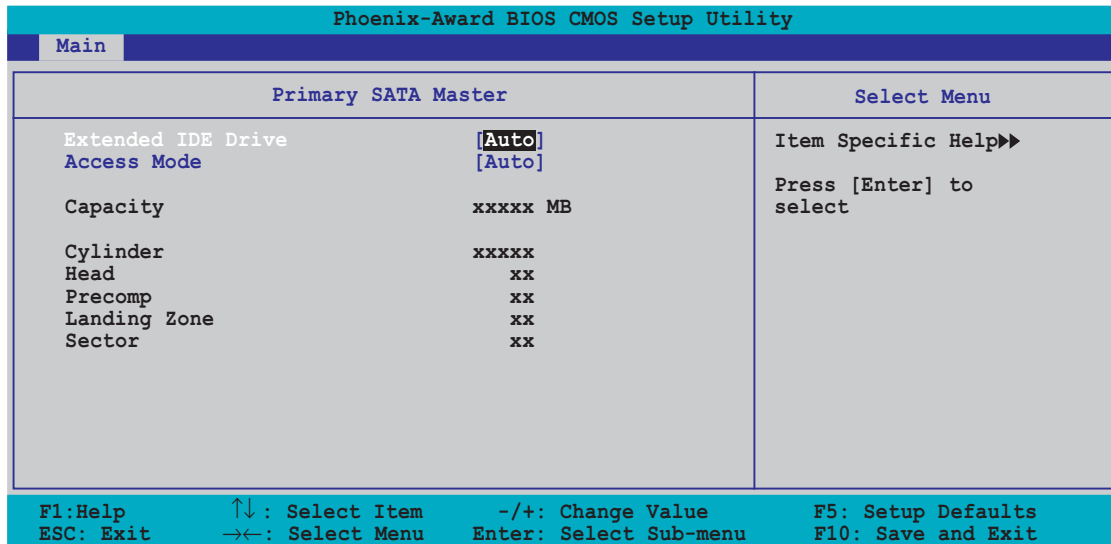

The BIOS automatically detects the values opposite the dimmed items (Capacity, Cylinder, Head, Precomp, Landing Zone and Sector). These values are not user-configurable. These items show 0 if no SATA device is installed in the system.

### Extended Drive

Selects the type of fixed disk connected to the system.

Configuration options: [None] [Auto]

### Access Mode

Sets the sector addressing mode. Configuration options: [Large] [Auto]



Before attempting to configure a hard disk drive, make sure you have the correct configuration information supplied by the drive manufacturer. Incorrect settings may cause the system to fail to recognize the installed hard disk.

### Capacity

Displays the auto-detected hard disk capacity. This item is not configurable.

### Cylinder

Shows the number of the hard disk cylinders. This item is not configurable.

## Head

Shows the number of the hard disk read/write heads. This item is not configurable.

## Precomp

Shows the number of precomp per track. This item is not configurable.

## Landing Zone

Shows the number of landing zone per track. This item is not configurable.

## Sector

Shows the number of sectors per track. This item is not configurable.



---

After entering the IDE hard disk drive information into BIOS, use a disk utility, such as FDISK, to partition and format new IDE hard disk drives. This is necessary so that you can write or read data from the hard disk. Make sure to set the partition of the Primary IDE hard disk drives to active.

---

### 4.3.7 HDD SMART Monitoring

Allows you to enable or disable the HDD Self-Monitoring Analysis and Reporting Technology (SMART) feature.

Configuration options: [Disabled] [Enabled]

### 4.3.8 Installed Memory

Shows the size of installed memory.

## 2.4 Advanced menu

The Advanced menu items allow you to change the settings for the CPU and other system devices.



Take caution when changing the settings of the Advanced menu items. Incorrect field values can cause the system to malfunction.

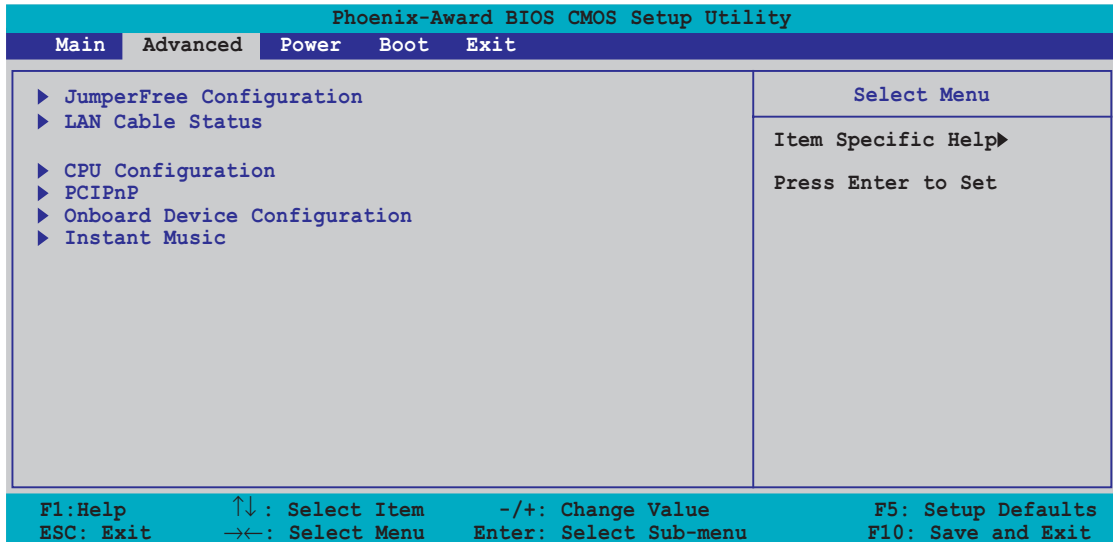

### 2.4.1 JumperFree Configuration

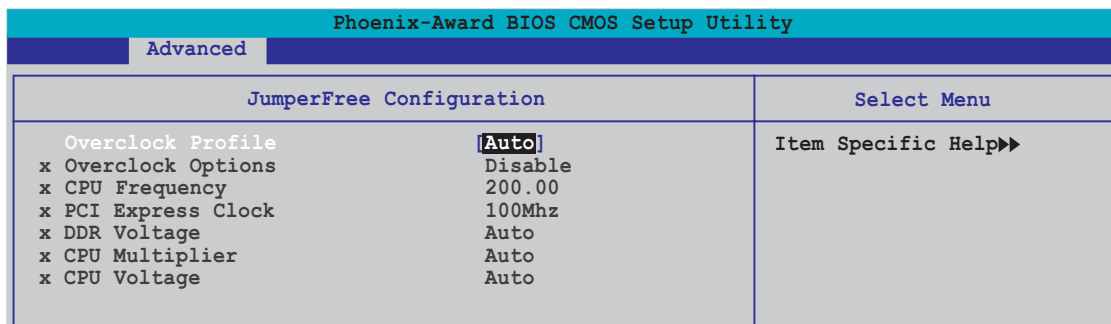

#### Overclock Profile [Auto]

Allows selection of CPU overclocking options to achieve desired CPU internal frequency. Select either one of the preset overclocking configuration options:

**Manual** Allows you to individually set overclocking parameters.

**Auto** Loads the optimal settings for the system.

**Standard** Loads the standard settings for the system.

**AI Overclock** Loads overclocking profiles with optimal parameters for stability when overclocking.

## Overclock Options [Disable]

Allows you to disable or set the overlocking options. The Overclock Options item is user-configurable only when the **Overclock Profile** is set to [AI Overclock]. Configuration options: [Disable] [Overclock 3%] [Overclock 5%] [Overclock 8%] [Overclock10%]



---

The following items are user-configurable only when the Overclock Profile item is set to [Manual].

---

## CPU Frequency [XXX] (value is auto-detected)

Indicates the frequency sent by the clock generator to the system bus and PCI bus. The bus frequency (external frequency) multiplied by the bus multiple equals the CPU speed. The value of this item is auto-detected by BIOS. The values range from 200 to 400. Refer to the following table for the correct Front Side Bus and CPU External Frequency settings.



---

Selecting a very high CPU frequency may cause the system to become unstable! If this happens, revert to the default setting.

---

## PCI Express Clock [100MHz]

Allows you to set the PCI Express clock. Key-in a decimal value between 100-200 MHz. Configuration options: [100Mhz] [101Mhz~[145Mhz]

## DDR Voltage [Auto]

Sets the operating DDR voltage. Configuration options: [Auto] [2.60V] [2.65V] [2.70V] [2.75V] [2.80V] [2.85V] [2.90V] [2.95V] [3.00V]

## CPU Multiplier [Auto]

Sets the operating CPU multiplier. The configuration options vary depending on the type of CPU installed. Configuration options: [Auto] [x4] [x4.5] [x5] [x5.5] [x6] [x6.5] [x7] [x7.5] [x7.5] [x8] [x8.5] [x9] [x9.5] [x10] [x10.5] [x11]

## CPU Voltage [Auto]

Sets the operating CPU voltage. The configuration options vary depending on the type of CPU installed. Configuration options: [Auto] [1.650V] [1.625V] [1.600V] [1.575V] [1.550V] [1.525V] [1.500V] [1.475V] [1.450V] [1.425V] [1.400V] [1.375V] [1.350V] [1.325V] [1.300V] [1.275V] [1.250V] [1.225V] [1.200V] [1.175V] [1.150V] [1.125V] [1.100V] [1.075V] [1.050V] [1.025V] [1.000V] [0.975V] [0.950V] [0.925V] [0.900V] [0.875V] [0.850V] [0.825V] [0.800V]

## 2.4.2 LAN Cable Status

The items in this menu displays the status of the Local Area Network (LAN) cable.

Phoenix-Award BIOS CMOS Setup Utility		
Advanced		
LAN Cable Status		Select Menu
POST Check LAN Cable		[Disabled]
Pair	Status	Length
LAN1 (1-2)	Open	N/A
LAN2 (3-6)	Open	N/A
LAN3 (4-5)	Open	N/A
LAN4 (7-8)	Open	N/A
		Item Specific Help▶▶▶

### POST Check LAN cable [Disabled]

Enables or disables checking of the LAN cable during the Power-On Self-Test (POST). Configuration options: [Disabled] [Enabled]

## 2.4.3 CPU Configuration

Phoenix-Award BIOS CMOS Setup Utility		
Advanced		
CPU Configuration		Select Menu
CPU Type	AMD Athlon(tm) 64 Processor 3200+	Item Specific Help▶▶▶
CPU Speed	3200MHz	
Cache RAM	512K	
▶ DRAM Configuration		DRAM timing and control
Hyper Transport Frequency	[4x]	
AMD K8 Cool'n'Quiet control	[Auto]	

### DRAM Configuration

The items in this sub-menu show the DRAM-related information auto-detected by the BIOS.

Phoenix-Award BIOS CMOS Setup Utility		
Advanced		
DRAM Configuration		Select Menu
Timing Mode	[Auto]	Item Specific Help▶▶▶▶▶
x Memclock index value (Mhz)	200Mhz	
x CAS# latency (Tcl)	2.5	
x Min RAS# active time(Tras)	9T	
x RAS# to CAS# delay (Trcd)	4T	
x Row precharge Time (Trp)	4T	
x 1T/2T Memory Timing	2T	
S/W DRAM Over 4G Remapping	[Enabled]	Place an artificial memory clock limit on the system. Memory is prevented from running faster than this frequency.

Timing Mode [Auto]

Sets the timing mode. Configuration options: [Auto] [Manual]

Memclock index value (Mhz) [200Mhz]

Sets the memory clock index value.  
Configuration options: [100Mhz] [133Mhz] [166Mhz] [200Mhz]

CAS# latency (Tcl) [2.5]

Sets the CAS# latency.  
Configuration options: [2] [2.5] [3]

Min RAS# active time (Tras) [9T]

Sets the minimum RAS# active time.  
Configuration options: [5T] [6T] [7T] [8T] [9T] [10T] [11T] [12T]  
[13T] [14T] [15T]

RAS# to CAS# delay (Trcd) [4T]

Sets the RAS# to CAS# delay to Rd/Wr command on the same bank.  
Configuration options: [2T] [3T] [4T] [5T] [6T] [7T]

Row precharge Time (Trp) [4T]

Sets the Row precharge time. Precharge to Active or Auto-Refresh of the same bank. Configuration options: [2T] [3T] [4T] [5T] [6T] [7T]

1T/2T Memory Timing [1T]

Sets the memory timing. Configuration options: [1T] [2T]

S/W DRAM Over 4G Remapping [Enabled]

Enables or disables the software DRAM remapping when using over 4G of system memory. Configuration options: [Disabled] [Enabled]



---

The default value of the items above may vary depending on the type of memory installed.

---

## **Hyper Transport Frequency [4x]**

Sets the Hyper Transport frequency.  
Configuration options: [Auto] [1x] [2x] [3x] [4x]

## **AMD K8 Cool'n'Quiet control [Disabled]**

Enables or disables the AMD Cool 'n' Quiet! technology.  
Configuration options: [Enabled] [Disabled]

## 2.4.4 PCIPnP

Phoenix-Award BIOS CMOS Setup Utility		
Advanced		
Frequency/Voltage control		Select Menu
Plug & Play O/S	<b>No</b>	Item Specific Help▶▶
Init Display First	[PCI Slot]	
Resources Controlled By	[Auto]	
x IRQ Resources		

### Plug & Play O/S [No]

When set to [No], the BIOS configures all the devices in the system. When set to [Yes] and if you install a Plug and Play operating system, the operating system configures the Plug and Play devices not required for boot. Configuration options: [No] [Yes]

### Init Display First [PCI Slot]

Sets which graphics controller to use as primary boot device. Configuration options: [PCI Slot] [PCIEx]

### Resources Controlled By [Auto]

When set to [Auto], the BIOS automatically configures all the boot and Plug and Play compatible devices. Set to [Manual] if you want to assign the IRQ DMA and memory base address fields. Configuration options: [Auto] [Manual]



When the item Resources Controlled By is set to [Auto], the item IRQ Resources is grayed out and not user-configurable. Refer to the section "IRQ Resources" for information on how to enable this item.

### IRQ Resources

This sub-menu is activated only when the **Resources Controlled By** item is set to Manual.

Phoenix-Award BIOS CMOS Setup Utility		
Advanced		
IRQ Resources		Select Menu
IRQ-3 assigned to	<b>[PCI Device]</b>	Item Specific Help▶▶▶
IRQ-4 assigned to	[PCI Device]	
IRQ-5 assigned to	[PCI Device]	Legacy ISA for devices compliant with the original PC AT bus specification, PCI/ISA PnP for devices compliant with the
IRQ-7 assigned to	[PCI Device]	
IRQ-9 assigned to	[PCI Device]	
IRQ-10 assigned to	[PCI Device]	
IRQ-11 assigned to	[PCI Device]	
IRQ-12 assigned to	[PCI Device]	
IRQ-14 assigned to	[PCI Device]	
IRQ-15 assigned to	[PCI Device]	

### IRQ-xx assigned to

When set to [PCI Device], the specific IRQ is free for use of PCI/PnP devices. When set to [Reserved], the IRQ is reserved for legacy ISA devices. Configuration options: [PCI Device] [Reserved]

## 2.4.5 Onboard Devices Configuration

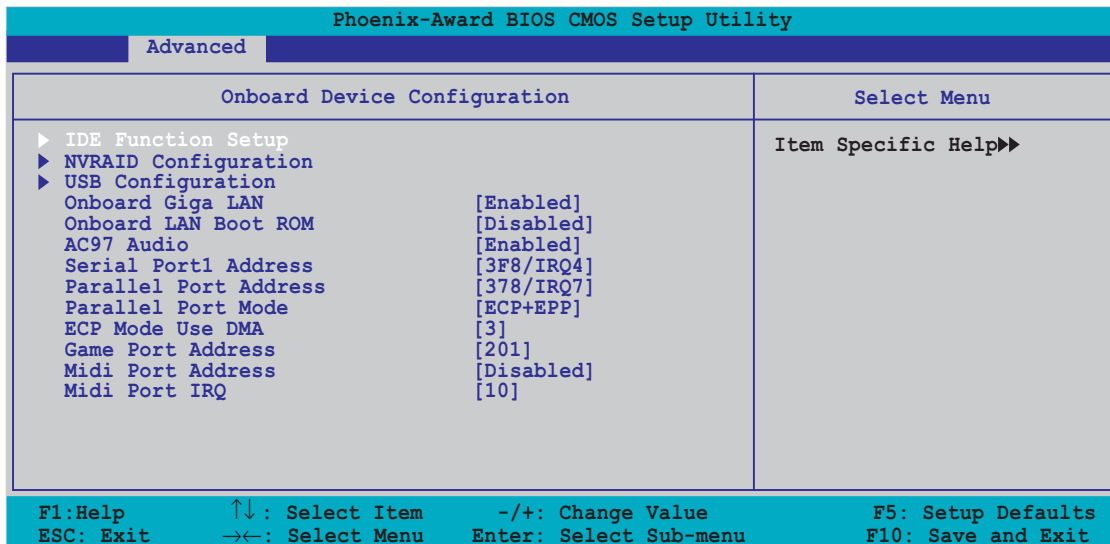

### IDE Function Setup

This sub-menu contains IDE function-related items. Select an item then press <Enter> to edit.

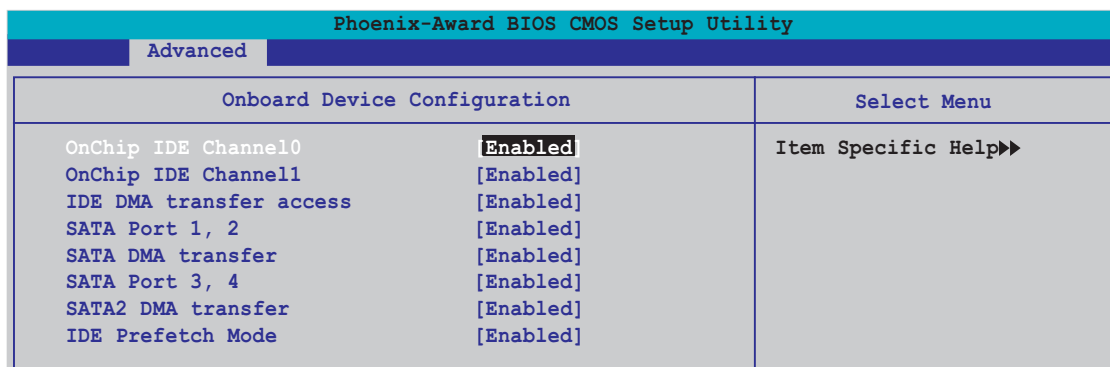

#### OnChip IDE Channel0 [Enabled]

Allows you to enable or disable the onchip IDE channel 0 controller .  
Configuration options: [Disabled] [Enabled]

#### OnChip IDE Channel1 [Enabled]

Allows you to enable or disable the onchip IDE channel 1 controller .  
Configuration options: [Disabled] [Enabled]



## IDE DMA transfer access [Enabled]

Allows you to enable or disable the IDE DMA transfer access.  
Configuration options: [Disabled] [Enabled]

## SATA Port 1, 2 [Enabled]

Allows you to enable or disable the SATA 1 and 2 ports.  
Configuration options: [Enabled] [Disabled]

## SATA DMA access [Enabled]

Allows you to enable or disable the SATA DMA transfer access.  
Configuration options: [Enabled] [Disabled]

## SATA Port 3, 4 [Enabled]

Allows you to enable or disable the SATA 3 and 4 ports.  
Configuration options: [Enabled] [Disabled]

## SATA2 DMA transfer [Enabled]

Allows you to enable or disable the SATA2 DMA transfer access.  
Configuration options: [Enabled] [Disabled]

## IDE Prefetch Mode [Enabled]

Allows you to enable or disable the IDE prefetch mode.  
Configuration options: [Disabled] [Enabled]

## NVRAID Configuration

This sub-menu contains NVRAID function-related items. Select an item then press <Enter> to edit.

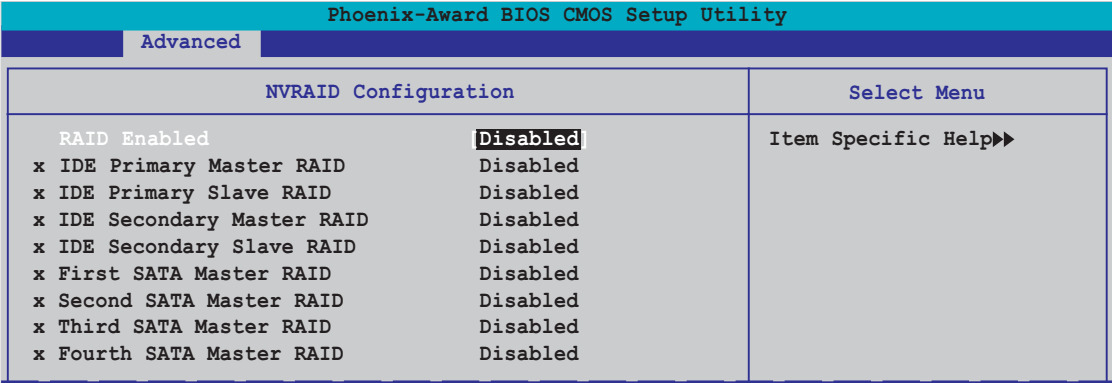

The screenshot shows the Phoenix-Award BIOS CMOS Setup Utility. The 'Advanced' menu is selected. The 'NVRAID Configuration' sub-menu is displayed, showing the following options:

NVRAID Configuration		Select Menu
RAID Enabled	<b>Disabled</b>	Item Specific Help▶▶
x IDE Primary Master RAID	Disabled	
x IDE Primary Slave RAID	Disabled	
x IDE Secondary Master RAID	Disabled	
x IDE Secondary Slave RAID	Disabled	
x First SATA Master RAID	Disabled	
x Second SATA Master RAID	Disabled	
x Third SATA Master RAID	Disabled	
x Fourth SATA Master RAID	Disabled	

## RAID Enabled [Disabled]

Enables or disables the onboard RAID controller. When Enabled, the succeeding items becomes user-configurable.  
Configuration options: [Disabled] [Enabled]

## IDE Primary, Secondary Master/Slave RAID [Disabled]

Enables or disables the RAID function of the primary or secondary master or slave IDE. Configuration options: [Disabled] [Enabled]

## First, Second, Third, Fourth SATA Master RAID [Disabled]

Enables or disables the RAID function of the first, second, third or fourth SATA master drive. Configuration options: [Disabled] [Enabled]

## USB Configuration

The items in this menu allows you to change the USB-related features. Select an item then press <Enter> to display the configuration options.

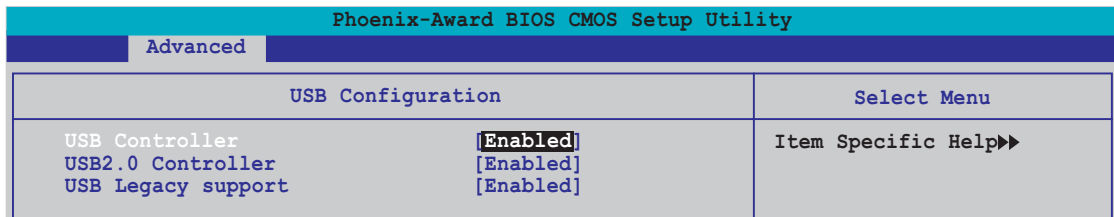

The screenshot shows the Phoenix-Award BIOS CMOS Setup Utility. The 'Advanced' menu is selected. The 'USB Configuration' menu is displayed, showing the following options:

USB Configuration		Select Menu
USB Controller	[Enabled]	Item Specific Help▶▶
USB2.0 Controller	[Enabled]	
USB Legacy support	[Enabled]	

## USB Controller [Enabled]

Allows you to enable or disable the onchip USB controller. Configuration options: [Disabled] [Enabled]

## USB 2.0 Controller [Enabled]

Allows you to enable or disable the USB 2.0 controller. Configuration options: [Disabled] [Enabled]

## USB Legacy Support [Enabled]

Allows you to enable or disable support for USB devices on legacy operating systems (OS). Configuration options: [Disabled] [Enabled]

---

## Onboard Giga LAN [Enabled]

Enables or disables the onboard NVIDIA® Gigabit LAN controller. Configuration options: [Disabled] [Enabled]

## OnBoard LAN Boot ROM [Disabled]

Allows you to enable or disable the onboard LAN boot ROM. Configuration options: [Enabled] [Disabled]

## AC97 Audio [Enabled]

Allows you to disable or enabled the onboard AC97 audio controller. Configuration options: [Disabled] [Enabled]

## Serial Port1 Address [3F8/IRQ4]

Allows you to select the Serial Port1 base address.

Configuration options: [Disabled] [3F8/IRQ4] [2F8/IRQ3] [3E8/IRQ4] [2E8/IRQ3] [Auto]

## Parallel Port Address [378/IRQ7]

Allows you to select the Parallel Port base addresses.

Configuration options: [Disabled] [378/IRQ7] [278/IRQ5] [3BC/IRQ7]

## Parallel Port Mode [ECP+EPP]

Allows you to select the Parallel Port mode.

Configuration options: [SPP] EPP] [ECP] [ECP+EPP]

## ECP Mode Use DMA [3]

Allows selection of ECP Mode. Configuration options: [1] [3]

## Game Port Address [201]

Allows you to select the Game Port address or to disable the port.

Configuration options: [Disabled] [201] [209]

## Midi Port Address [330]

Allows you to select the Game Port address or to disable the port.

Configuration options: [Disabled] [330] [300]

## Midi Port IRQ [10]

Allows you to set the Midi port IRQ address. Configuration options: [5] [10]

## 2.4.6 Instant Music

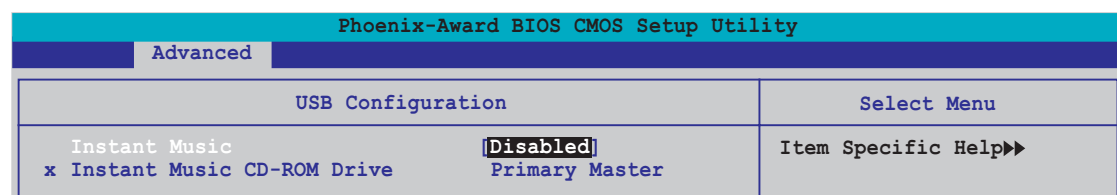

### Instant Music [Disabled]

Allows you to enable or disable the ASUS Instant Music feature.

Configuration options: [Disabled] [Enabled]



Enabling Instant Music automatically disables the PS/2 keyboard power up feature.

## Instant Music CD-ROM Drive [Primary Master]

Allows you to select the CD-ROM drive that you wish to use for the Instant Music CD playback. This item is configurable only if the **Instant Music** item is set to [Enabled]. Configuration options: [Primary Master] [Primary Slave] [Secondary Master] [Secondary Slave]

## 2.5 Power menu

The Power menu items allow you to change the settings for the Advanced Configuration and Power Interface (ACPI) and the Advanced Power Management (APM). Select an item then press <Enter> to display the configuration options.

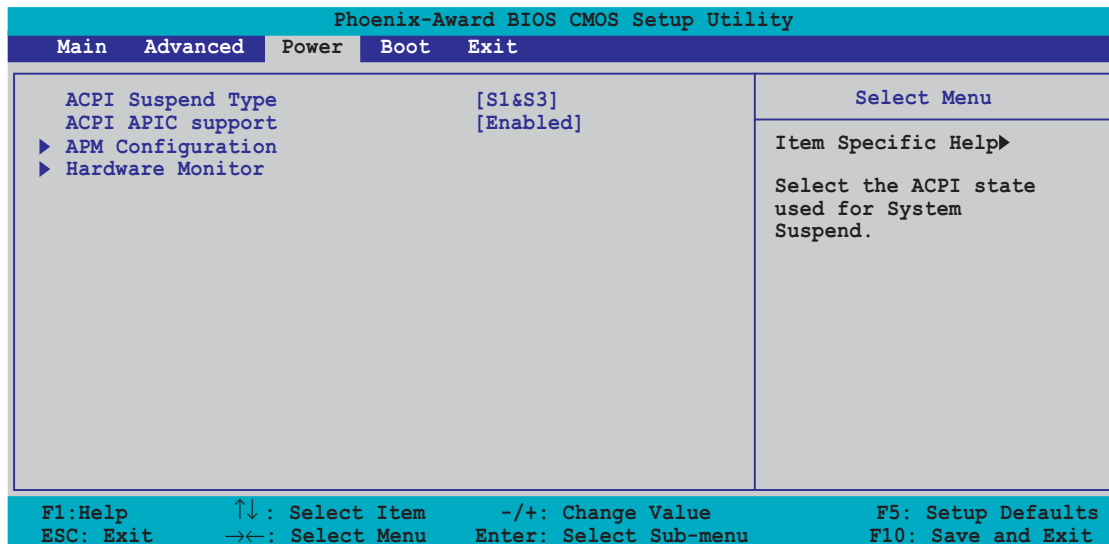

### 2.5.1 ACPI Suspend Type [S1&S3]

Allows you to select the Advanced Configuration and Power Interface (ACPI) state to be used for system suspend.

Configuration options: [S1 (POS)] [S3(STR)] [S1&S3]

### 2.5.2 ACPI APIC Support [Enabled]

Allows you to enable or disable the Advanced Configuration and Power Interface (ACPI) support in the Application-Specific Integrated Circuit (ASIC). When set to Enabled, the ACPI APIC table pointer is included in the RSDT pointer list. Configuration options: [Disabled] [Enabled]

## 2.5.3 APM Configuration

Phoenix-Award BIOS CMOS Setup Utility		
Power		
APM Configuration	Select Menu	
Restore on AC Power Loss	<b>[Disabled]</b>	Item Specific Help▶▶  Press [ENTER] to select whether or not to restart the system after AC power loss.
PWR Button < 4 secs	[Instant Off]	
Power On By PCI Devices	[Disabled]	
Power On By External Modems	[Disabled]	
Power-On by RTC Alarm	[Disabled]	
x Date (of Month)	0	
x Resume Time (hh:mm:ss)	0 : 0 : 0	
Power Up By PS/2 Mouse	[Disabled]	
Power Up By PS/2 Keyboard	[Disabled]	
F1: Help      ↑↓: Select Item      -/+ : Change Value      F5: Setup Defaults		
ESC: Exit     →←: Select Menu      Enter: Select Sub-menu      F10: Save and Exit		

### Restore on AC Power Loss [Disabled]

Allows you to enable or disable the Restore on AC Power Loss function. Configuration options: [Disabled] [Enabled]

### PWR Button < 4 secs [Instant-Off]

Allows you to set the event after the power button is pressed for more than 4 seconds. Configuration options: [Suspend] [Instant-Off]

### Power On By PCI Devices [Disabled]

When set to [Enabled], this parameter allows you to turn on the system through a PCI LAN or modem card. This feature requires an ATX power supply that provides at least 1A on the +5VSB lead. Configuration options: [Disabled] [Enabled]

### Power On By External Modems [Disabled]

This allows either settings of [Enabled] or [Disabled] for powering up the computer when the external modem receives a call while the computer is in Soft-off mode. Configuration options: [Disabled] [Enabled]



---

The computer cannot receive or transmit data until the computer and applications are fully running. Thus, connection cannot be made on the first try. Turning an external modem off and then back on while the computer is off causes an initialization string that turns the system power on.

---

### **Power On By RTC Alarm [Disabled]**

Allows you to enable or disable RTC to generate a wake event. When this item is set to Enabled, the items Date of Month Alarm and Time (hh:mm:ss) Alarm items become user-configurable with set values.

Configuration options: [Disabled] [Enabled]

### **Day of Month Alarm [Disabled]**

To set the date of alarm, highlight this item and press <Enter> to display the Day of Month Alarm pop-up menu. Key-in a value within the specified range then press <Enter>. Configuration options: [Min=0] [Max=31]

### **Time (hh:mm:ss) Alarm [Disabled]**

To set the time of alarm:

1. Highlight this item and press <Enter> to display a pop-up menu for the hour field.
2. Key-in a value (Min=0, Max=23), then press <Enter>.
3. Press <TAB> to move to the minutes field then press <Enter>.
4. Key-in a minute value (Min=0, Max=59), then press <Enter>.
5. Press <TAB> to move to the seconds field then press <Enter>.
6. Key-in a value (Min=0, Max=59), then press <Enter>.

### **Power Up By PS/2 Mouse [Disabled]**

When set to [Enabled], this parameter allows you to use the PS/2 mouse to turn on the system. This feature requires an ATX power supply that provides at least 1A on the +5VSB lead.

Configuration options: [Disabled] [Enabled]

### **Power On By PS/2 Keyboard [Disabled]**

Allows you to disable the Power On by PS/2 keyboard function or set specific keys on the PS/2 keyboard to turn on the system. This feature requires an ATX power supply that provides at least 1A on the +5VSB lead.

Configuration options: [Disabled] [Space Bar] [Ctrl-ESC] [Power Key]

## 2.5.4 Hardware Monitor

The items in this sub-menu displays the hardware monitor values automatically detected by the BIOS. It also allows you to change CPU Q-Fan feature-related parameters. Select an item then press <Enter> to display the configuration options.

Phoenix-Award BIOS CMOS Setup Utility		
Power		
Hardware Monitor		Select Menu
Q-Fan Controller	[Disabled]	Item Specific Help▶▶
Vcore Voltage	1.50V	
3.3V Voltage	3.31V	
5V Voltage	4.94V	
12V Voltage	11.26V	
CPU Temperature	48°C	
M/B Temperature	38°C	
CPU FAN Speed	4962 RPM	
CHIP FAN Speed	5443 RPM	
x CPU Target Temperature	72°C	
CPU Fan Speed warning	[1200 RPM]	
CHIP Fan Speed warning	[Enabled]	

F1: Help      ↑↓: Select Item      -/+ : Change Value      F5: Setup Defaults  
ESC: Exit      →←: Select Menu      Enter: Select Sub-menu      F10: Save and Exit

### Q-Fan Controller [Disabled]

Allows you to enable or disable the Q-Fan controller.  
Configuration options: [Disabled] [Enabled]

### VCORE Voltage, +12V Voltage, 3.3V Voltage, 5VCC Voltage

The onboard hardware monitor automatically detects the voltage output through the onboard voltage regulators. These items are not user-configurable.

### CPU Temperature, M/B Temperature

The onboard hardware monitor automatically detects and displays the motherboard and CPU temperatures. These items are not user-configurable.

### CPU Fan Speed CHIP Fan Speed

The onboard hardware monitor automatically detects and displays the CPU and chip fan speeds in rotations per minute (RPM). If the fan is not connected to the motherboard, the field shows 0. These items are not user-configurable.

## CPU Target Temperature

Allows you to set the temperature threshold before the CPU fan rotates at full speed. Configuration options: [51°C] [54°C] [57°C] [60°C] [63°C] [66°C] [69°C] [72°C] [75°C] [78°C] [81°C]

## CPU Fan Speed warning

Enables, disables or sets the CPU fan speed warning feature. Configuration options: [Disabled] [800 RPM] [1200 RPM] [1600 RPM]

## CHIP Fan Speed warning

Enables or disables the chipset fan speed warning feature. Configuration options: [Disabled] [Enabled]

## 2.6 Boot menu

The Boot menu items allow you to change the system boot options. Select an item then press <Enter> to display the sub-menu.

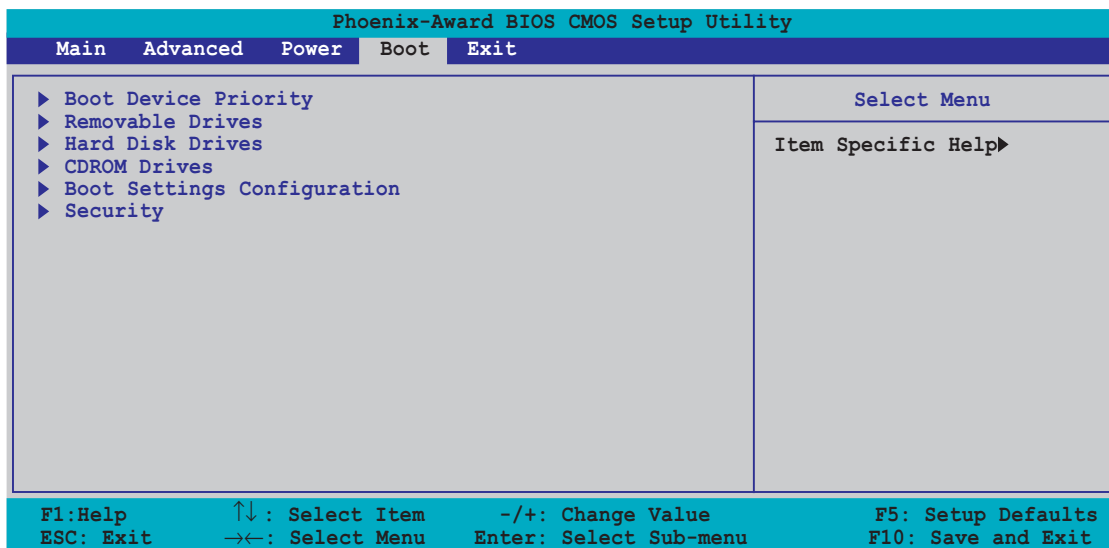

### 2.6.1 Boot Device Priority

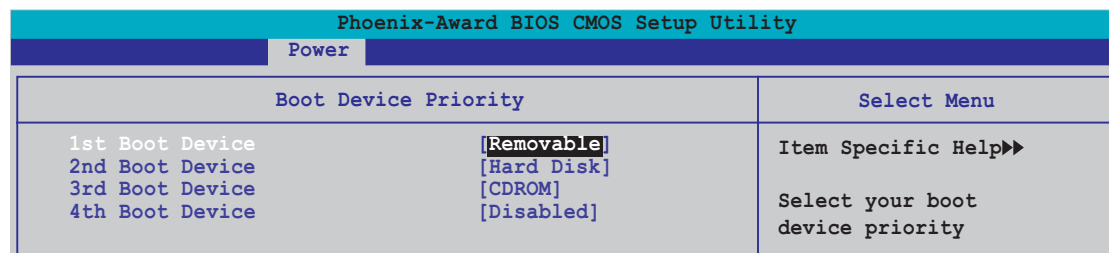



## 1st ~ xxth Boot Device [Removable]

These items specify the boot device priority sequence from the available devices. The number of device items that appears on the screen depends on the number of devices installed in the system.

Configuration options: [Removable] [Hard Disk] [CDROM] [Legacy LAN] [Disabled]

### 2.6.2 Removable Drives

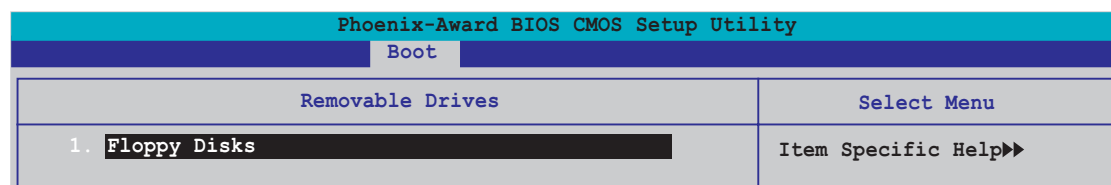

#### 1. Floppy Disks

Allows you to assign a removable drive attached to the system.

### 2.6.3 Hard Disk Drives

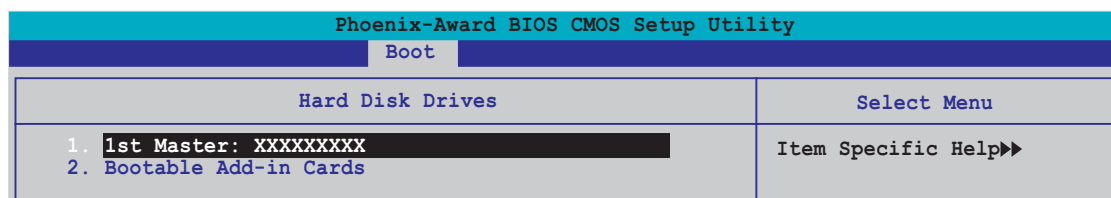

#### 1. 1st Master: XXXXXXXXXX

Allows you to assign hard disk drives attached to the system.

### 2.6.4 CDROM Drives

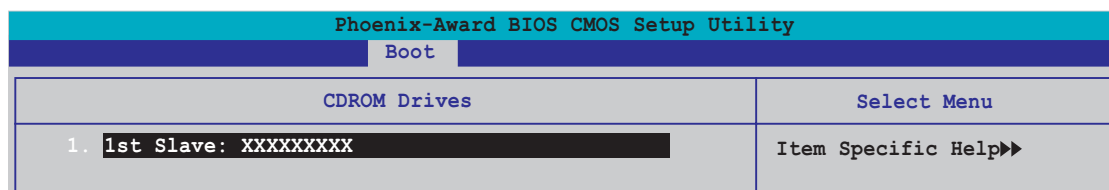

#### 1. 1st Slave: XXXXXXXXXX

Allows you to assign optical drives attached to the system.

## 2.6.5 Boot Settings Configuration

Phoenix-Award BIOS CMOS Setup Utility		
Boot		
Boot Settings Configuration		Select Menu
Case Open Warning	[Enabled]	Item Specific Help▶▶  Press [Enter] to enable or disable.
Quick Boot	[Enabled]	
Boot Up Floppy Seek	[Enabled]	
Bootup Num-Lock	[On]	
Typematic Rate Setting	[Disabled]	
x Typematic Rate (Chars/Sec)	6	
x Typematic Delay (Msec)	250	
OS Select For DRAM > 64MB	[Non-OS2]	
Full Screen LOGO	[Enabled]	
Halt On	[All Errors]	

F1: Help      ↑↓: Select Item      -/+ : Change Value      F5: Setup Defaults  
ESC: Exit      →←: Select Menu      Enter: Select Sub-menu      F10: Save and Exit

### Case Open Warning [Enabled]

Enables or disables the chassis open status feature. Setting to Enabled, clears the chassis open status. Refer to section “2.7 Internal connectors” for setting details. Configuration options: [Disabled] [Enabled]

### Quick Boot [Enabled]

Allows you to enable or disable the system quick boot feature. When Enabled, the system skips certain tests while booting. Configuration options: [Disabled] [Enabled]

### Boot Up Floppy Seek [Enabled]

Enables or disables the chassis open status feature. Setting to Enabled, clears the chassis open status. Configuration options: [Disabled] [Enabled]

### Bootup Num-Lock [On]

Allows you to select the power-on state for the NumLock. Configuration options: [Off] [On]

### Typematic Rate Setting [Disabled]

Allows you to set the keystroke rate. Enable this item to configure the **Typematic Rate (Chars/Sec)** and the **Typematic Delay (Msec)**. Configuration options: [Disabled] [Enabled]



The items **Typematic Rate (Chars/Sec)** and **Typematic Delay (Msec)** becomes user-configurable only when the item Typematic Rate Setting is enabled.

## Typematic Rate (Chars/Sec) [6]

Allows you to select the rate at which a character repeats when you hold a key. Configuration options: [6] [8] [10] [12] [15] [20] [24] [30]

## Typematic Delay (Msec) [250]

Allows you to set the delay before keystrokes begin to repeat. Configuration options: [250] [500] [750] [1000]

## OS Select for DRAM > 64MB [Non-OS2]

Set this item to OS2 only when you are running on an OS/2 operating system with an installed RAM of greater than 64 KB. Configuration options: [Non-OS2] [OS2]

## Full Screen LOGO [Enabled]

Allows you to enable or disable the full screen logo display feature. Configuration options: [Disabled] [Enabled]



- Make sure that the above item is set to [Enabled] if you want to use the ASUS MyLogo2™ feature.
- See section “3.3.1 ASUS MyLogo2™” for details.

## Halt On [All Errors]

Allows you to error report type. Configuration options: [All Errors] [No Errors] [All, But Keyboard] [All, But Diskette] [All, But Disk/Key]

## 2.6.6 Security

Phoenix-Award BIOS CMOS Setup Utility		
Boot		
Boot Settings Configuration		Select Menu
Supervisor Password	Clear	Item Specific Help▶▶
User Password	Clear	
Password Check	[Setup]	

### Supervisor Password

### User Password

These fields allow you to set passwords:

To set a password:

1. Select an item then press <Enter>.
2. Type in a password using a combination of a maximum of eight (8) alpha-numeric characters, then press <Enter>.

3. When prompted, confirm the password by typing the exact characters again, then press <Enter>. The password field setting is changed to Set.

To clear the password:

1. Select the password field and press <Enter> twice. The following message appears:

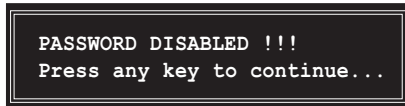

2. Press any key to continue. The password field setting is changed to Clear.

### **A note about passwords**

The Supervisor password is required to enter the BIOS Setup program preventing unauthorized access. The User password is required to boot the system preventing unauthorized use.

### **Forgot your password?**

If you forget your password, you can clear it by erasing the CMOS Real Time Clock (RTC) RAM. The RAM data containing the password information is powered by the onboard button cell battery. If you need to erase the CMOS RAM, refer to section “2.6 Jumpers” for instructions.

### **Password Check**

This field requires you to enter the password before entering the BIOS setup or the system. Select [Setup] to require the password before entering the BIOS Setup. Select [System] to require the password before entering the system. Configuration options: [Setup] [System]

## 2.7 Exit menu

The Exit menu items allow you to load the optimal or failsafe default values for the BIOS items, and save or discard your changes to the BIOS items.

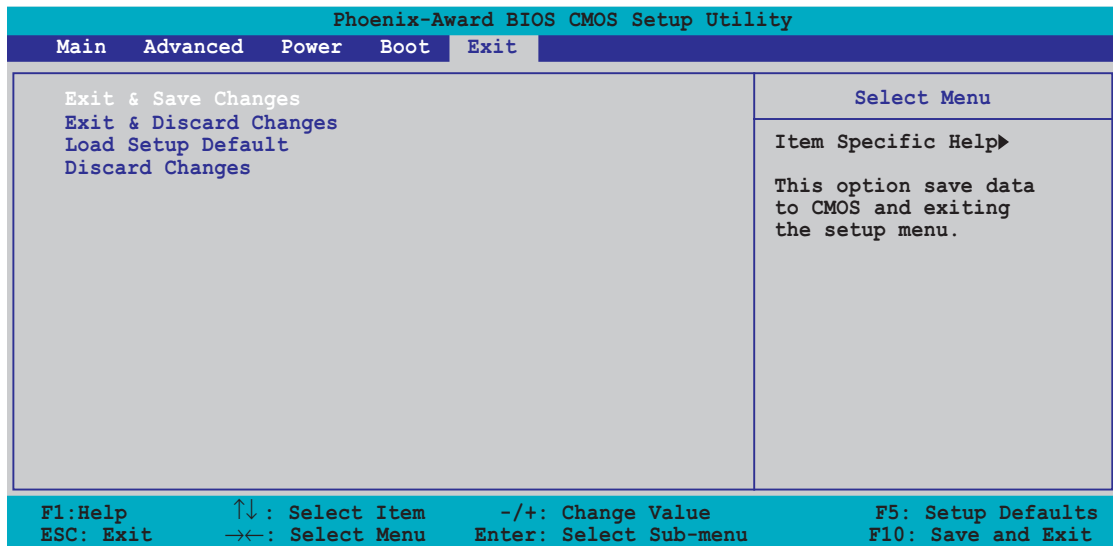

Pressing <Esc> does not immediately exit this menu. Select one of the options from this menu or <F10> from the legend bar to exit.

### Exit & Save Changes

Once you are finished making your selections, choose this option from the Exit menu to ensure the values you selected are saved to the CMOS RAM. An onboard backup battery sustains the CMOS RAM so it stays on even when the PC is turned off. When you select this option, a confirmation window appears. Select **YES** to save changes and exit.



If you attempt to exit the Setup program without saving your changes, the program prompts you with a message asking if you want to save your changes before exiting. Press <Enter> to save the changes while exiting.

### Exit & Discard Changes

Select this option only if you do not want to save the changes that you made to the Setup program. If you made changes to fields other than System Date, System Time, and Password, the BIOS asks for a confirmation before exiting.

## Load Setup Defaults

This option allows you to load the default values for each of the parameters on the Setup menus. When you select this option or if you press <F5>, a confirmation window appears. Select **YES** to load default values. Select **Exit & Save Changes** or make other changes before saving the values to the non-volatile RAM.

## Discard Changes

This option allows you to discard the selections you made and restore the previously saved values. After selecting this option, a confirmation appears. Select **YES** to discard any changes and load the previously saved values.

This chapter describes the contents of the support CD that comes with the motherboard package.

# Software support

A large, light gray, stylized number '3' is positioned behind the text 'Software support', partially overlapping it.

## 3.1 Installing an operating system

This motherboard supports Windows® 2000/XP operating systems (OS). Always install the latest OS version and corresponding updates to maximize the features of your hardware.



- Motherboard settings and hardware options vary. Use the setup procedures presented in this chapter for reference only. Refer to your OS documentation for detailed information.
- Make sure that you install Windows® 2000 Service Pack 4 or the Windows® XP Service Pack 2 or later versions before installing the drivers for better compatibility and system stability.

## 3.2 Support CD information

The support CD that came with the motherboard package contains the drivers, software applications, and utilities that you can install to avail all motherboard features.



The contents of the support CD are subject to change at any time without notice. Visit the ASUS website([www.asus.com](http://www.asus.com)) for updates.

### 3.2.1 Running the support CD

Place the support CD to the optical drive. The CD automatically displays the **Drivers** menu if Autorun is enabled in your computer.

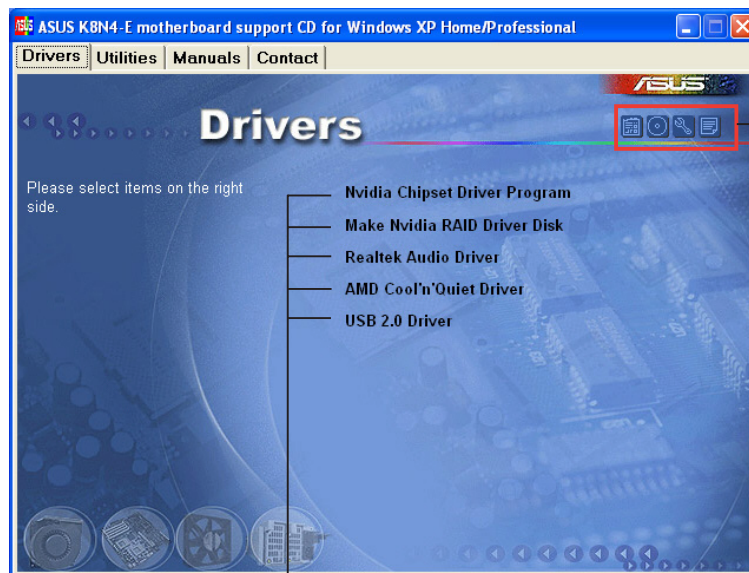

Click an icon to display support CD/motherboard information

Click an item to install



If **Autorun** is NOT enabled in your computer, browse the contents of the support CD to locate the file **ASSETUP.EXE** from the BIN folder. Double-click the **ASSETUP.EXE** to run the CD.



## 3.2.2 Drivers menu

The drivers menu shows the available device drivers if the system detects installed devices. Install the necessary drivers to activate the devices.

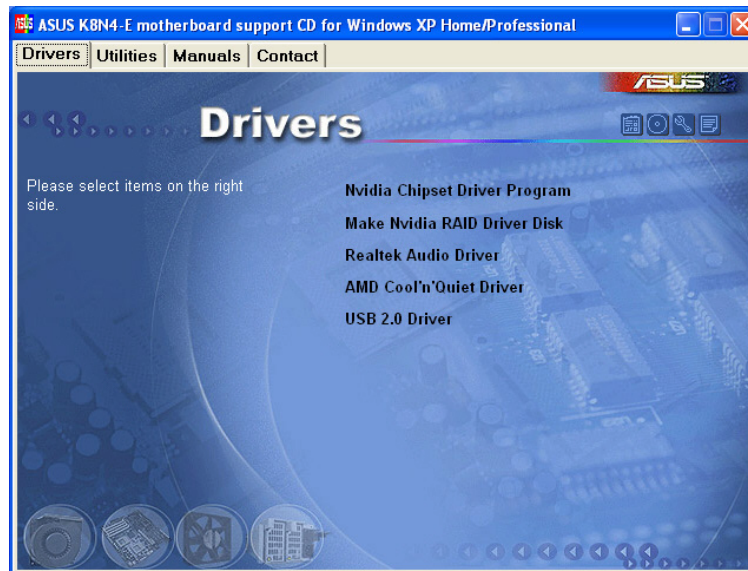

### **Nvidia Chipset Driver Program**

Installs the NVIDIA® Chipset drivers for the NVIDIA® nForce™ 4 chipset.

### **Make NVIDIA RAID Driver Disk**

Creates the NVIDIA® driver disk for Serial ATA and RAID features.

### **Realtek Audio Driver**

Installs the Realtek® ALC850 audio controller and application.

### **AMD Cool'n'Quiet Driver**

Installs the AMD Cool 'n' Quiet! Technology drivers.

### **USB 2.0 Driver**

Installs the Universal Serial Bus 2.0 (USB 2.0) driver.



---

The screen display and drivers option may not be the same for different operating system versions.

---

### 3.2.3 Utilities menu

The Utilities menu shows the applications and other software that the motherboard supports.



#### **NVIDIA Chipset nTune Utility**

Installs the NVIDIA® nTune™ utility that allows easy and safe system tuning for optimum performance.

#### **ASUS PC Probe II**

This smart utility monitors the fan speed, CPU temperature, and system voltages, and alerts you of any detected problems. This utility helps you keep your computer in healthy operating condition.

#### **ASUS Update**

Allows you to download the latest version of the BIOS from the ASUS website.



---

Before using the ASUS Update, make sure that you have an Internet connection so you can connect to the ASUS website.

---

#### **ASUS Screen Saver**

Bring life to your computer screen by installing the ASUS screen saver.

#### **ADOBE Acrobat Reader**

Installs the Adobe® Acrobat® Reader that allows you to open, view, and print documents in Portable Document Format (PDF).

## **Microsoft DirectX**

Installs the Microsoft® DirectX 9.0c driver. The Microsoft DirectX® 9.0 is a multimedia technology that enhances computer graphics and sound. DirectX® improves the multimedia features of your computer so you can enjoy watching TV and movies, capturing videos, or playing games in your computer. Visit the Microsoft website ([www.microsoft.com](http://www.microsoft.com)) for updates.

## **ASUS AMD Cool 'n' Quiet Software**

Installs the AMD® Cool 'n' Quiet! software.

## **ASUS AI Booster**

The ASUS AI Booster application allows you to overclock the CPU speed in a Windows® environment.

## **Anti-virus Utility**

The anti-virus application detects and protects your computer from viruses that destroys data.

### 3.2.4 ASUS Contact information

Click the **Contact** tab to display the ASUS contact information. You can also find this information on the inside front cover of this user guide.

