

MX4SG-4DL
MX4SG-4DN
MX4SPB-N
Online Manual

DOC. NO.: MX4SG4DL-OL-E0311B

What's in this manual

MX4SG-4DL / MX4SG-4DN / MX4SPB-N..... 1

What's in this manual 2

You Must Notice 8

Before You Start 9

Overview 10

Feature Highlight 11

Quick Installation Procedure 16

Motherboard Map 17

Block Diagram 18

Hardware Installation 19

About "User Upgrade Optional" and "Manufacture Upgrade Optional" 20

JP14 Clear CMOS Data 21

CPU Installation 22



CPU Fan Installation 24

CPU Over-current Protection 26

AOpen "Watch Dog ABS" 28

Full-range Adjustable CPU Core Voltage 29



CPU and System Fan Connector (with H/W Monitoring)	31
JP28 Keyboard/Mouse Wake-up Jumper	32
DIMM Sockets	33
AC Power Auto Recovery	35
IDE and Floppy Connector	36
 Serial ATA Supported	38
Connecting Serial ATA Disk	39
Front Panel Connector	42
AGP (Accelerated Graphic Port) 8X Expansion Slot	43
AGP Protection Technology and AGP LED	44
IrDA Connector	45
Support 10/100/1000 Mbps LAN onboard	46
Support USB 2.0 Ports	47
Color Coded Back Panel	48
 S/PDIF (Sony/Philips Digital Interface) Connector	49
 Super 5.1 Channel Audio Effect	50
Wake On Modem / Wake On LAN / Wake On PCI Card	51
Front Audio Connector	52
CD Audio Connector	53

AUX-IN Connector.....	54
COM2 Connector.....	55
Case Open Connector.....	56
Resetable Fuse.....	57
Enlarged Aluminum Heatsink.....	58
Low ESR Capacitor.....	59
NEW! PBE – Performance Boosting Engine (for MX4SG-4DL / MX4SG-4DN).....	60
NEW! The noise is gone!! ---- SilentTek.....	61
NEW! Hyper Threading Technology.....	64
NEW! AOConfig Utility.....	66
Phoenix-AWARD BIOS.....	68
How To Use Phoenix-Award™ BIOS Setup Program.....	69
How To Enter BIOS Setup.....	70
NEW! BIOS Upgrade under Windows environment.....	71
NEW! Vivid BIOS technology.....	73
NEW! Driver and Utility –	74
Installing Drivers.....	75
Installing Utilities.....	76
Glossary	77



AC'97 CODEC..... 77

ACPI (Advanced Configuration & Power Interface)..... 77

ACR (Advanced Communication Riser) 77

AGP (Accelerated Graphic Port) 78

AMR (Audio/Modem Riser) 78

ATA (AT Attachment) 78

BIOS (Basic Input/Output System)..... 79

Bluetooth 79

CNR (Communication and Networking Riser)..... 80

DDR (Double Data Rate) SDRAM..... 80

ECC (Error Checking and Correction)..... 80

EEPROM (Electronic Erasable Programmable ROM) 80

EPROM (Erasable Programmable ROM)..... 81

EV6 Bus 81

FCC DoC (Declaration of Conformity)..... 81

FC-PGA (Flip Chip-Pin Grid Array)..... 81

FC-PGA2 (Flip Chip-Pin Grid Array)..... 81

Flash ROM 82

Hyper Threading..... 82



<i>IEEE 1394</i>	82
<i>Parity Bit</i>	83
<i>PCI (Peripheral Component Interface) Bus</i>	83
<i>PDF Format</i>	83
<i>PnP (Plug and Play)</i>	83
<i>POST (Power-On Self Test)</i>	84
<i>PSB (Processor System Bus) Clock</i>	84
<i>RDRAM (Rambus Dynamic Random Access Memory)</i>	84
<i>RIMM (Rambus Inline Memory Module)</i>	84
<i>SDRAM (Synchronous DRAM)</i>	84
<i>SATA (Serial ATA)</i>	85
<i>SMBus (System Management Bus)</i>	85
<i>SPD (Serial Presence Detect)</i>	85
<i>USB 2.0 (Universal Serial Bus)</i>	85
<i>VCM (Virtual Channel Memory)</i>	86
<i>Wireless LAN – 802.11b</i>	86
<i>ZIP file</i>	86
Troubleshooting	87
Technical Support	91



Product Registration..... 95
How to Contact Us..... 96

You Must Notice



Adobe, the Adobe logo, Acrobat is trademarks of Adobe Systems Incorporated.

AMD, the AMD logo, Athlon and Duron are trademarks of Advanced Micro Devices, Inc.

Intel, the Intel logo, Intel Celeron, Pentium II, Pentium III and Pentium 4 are trademarks of Intel Corporation.

Microsoft, Windows, and Windows logo are either registered trademarks or trademarks of Microsoft Corporation in the United States and/or other countries.

All product and brand names used on this manual are used for identification purposes only and may be the registered trademarks of their respective owners.

All of the specifications and information contained in this manual are subject to change without notice. AOpen reserves the right to revise this publication and to make reasonable changes. AOpen assumes no responsibility for any errors or inaccuracies that may appear in this manual, including the products and software described in it.

This documentation is protected by copyright law. All rights are reserved.

No part of this document may be used or reproduced in any form or by any means, or stored in a database or retrieval system without prior written permission from AOpen Corporation.

Copyright © 1996-2003, AOpen Inc. All Rights Reserved.

Before You Start



This Online Manual will introduce to the user how this product is installed. All useful information will be described in later chapters. Please keep this manual carefully for future upgrades or system configuration changes. This Online Manual is saved in [PDF format](#), we recommend using Adobe Acrobat Reader 5.0 for online viewing, it is included in Bonus CD or you can get free download from [Adobe web site](#).

Although this Online Manual is optimized for screen viewing, it is still capable for hardcopy printing, you can print it by A4 paper size and set 2 pages per A4 sheet on your printer. To do so, choose **File > Page Setup** and follow the instruction of your printer driver.

Thanks for the help of saving our earth.

Overview

Thank you for choosing AOpen MX4SG-4DL / MX4SG-4DN / MX4SPB-N motherboard. MX4SG-4DL / MX4SG-4DN is Intel® Socket 478 motherboard (M/B) based on the ATX form factor featuring the [Intel 865G chipsets](#) and MX4SPB-N is based on Intel 848PB chipsets. As high performance chipset built in the M/B, MX4SG-4DL / MX4SG-4DN / MX4SPB-N motherboard supports Intel® Socket 478 Pentium® 4 1.6GHz~3.20GHz. It supports 400/533/800MHz Front Side Bus (FSB) clock and [Hyper-Threading](#) Technology that brings additional intelligence to systems. In the [AGP](#) performance, it has one AGP slot to support AGP 8X/4X mode and pipelined spilt-transaction long burst transfer up to 2112MB/sec. MX4SG-4DL / MX4SG-4DN also supports ADD card. According to different customer's requirements, this motherboard supports [DDR266](#), [DDR333](#) and [DDR400](#) RAM up to 4GB maximum (MX4SPB-N is up to 2GB only). The onboard IDE controller supports [Ultra DMA 33/66/100](#) mode and [Serial ATA](#) 150 MB/s. A total of four [USB 2.0](#) ports on the back panel and two headers on the board give you the best use of all USB devices with the fancy speed up to 480Mbps. More than that, on the strength of integrated BCM LAN controller on board, which is a highly integrated Platform LAN Connect device, it provides 10/100 Mbps Ethernet (for MX4SG-4DL, it is 10/100/1000 Mbps) for office and home use. Besides, MX4SG-4DL / MX4SG-4DN / MX4SPB-N has S/PDIF connector and an [AC'97 CODEC RealTek ALC655](#) chipset onboard, providing high performance and magic surround stereo sound to let people enjoy working with it. Now, let's enjoy all features from AOpen MX4SG-4DL / MX4SG-4DN / MX4SPB-N motherboard.

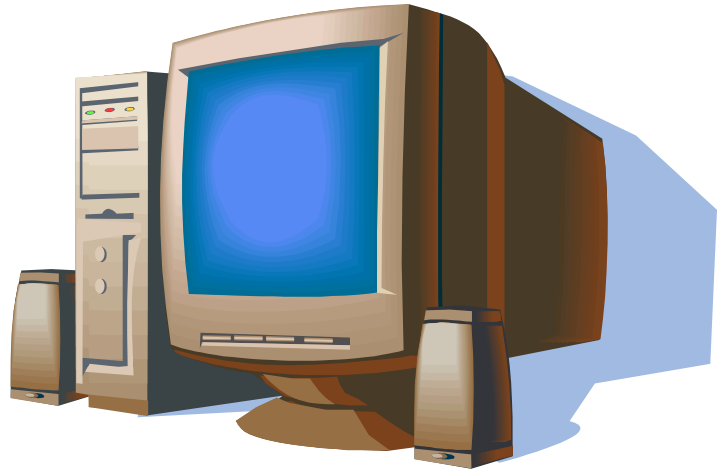

Feature Highlight

CPU

Supports Intel® Socket 478 Pentium® 4 (Northwood) 1.6GHz~3.20GHz+ with 400/533/800MHz Front Side Bus (FSB) designed for Socket 478 technology.

Chipset

Intel 865G is a Graphics Memory Controller Hub (GMCH) designed for use with the Pentium 4 processor with 512-KB L2 cache on 0.13-micron processor. It provides CPU, DDR, AGP, Hub, CSA Interfaces and integrated graphics with display interfaces. The CPU interface supports Pentium 4 processor subset of the Extended Mode of the Scalable Bus Protocol. The GMCH memory interface supports one up to two channels of DDR, and the AGP interface supports 0.8/1.5V signaling with 8X/4X data transfers and 8X/4X AGP Fast Writes. The integrated graphics controller provides 3D, 2D, and display capabilities while using a portion of system memory for graphics memory (UMA) to provide a cost effective, high performance graphics solution. The Intel 865 platform supports the fifth generation I/O Controller Hub.

The ICH5 integrates an Ultra ATA 100 controller, two Serial ATA host controllers, one EHCI host controller and four UHCI host controllers supporting eight external USB 2.0 ports, LPC interface controller; flash BIOS interface controller, PCI interface controller, AC'97 digital controller, integrated LAN controller, an ASF controller and a hub interface for communication with the 865 GMCH.

Memory

With Intel 865G chipset, MX4SG-4DL / MX4SG-4DN can support dual channel [Double-Data-Rate \(DDR\) RAM](#). The dual channel mode allows chipsets to get data in 128 bit and zero wait state bursting between the RAM. The data transfer at 266/333/400MHz. The four slots of DDR SDRAM can be composed of an arbitrary mixture of 64, 128, 256, 512 MB or 1GB DDR SDRAM and maximum up to 4GB. MX4SPB-N supports single channel DDR RAM maximum up to 2GB only.

Expansion Slots

Including three 32-bit/33MHz PCI and one AGP 8X/4X slots. The [PCI](#) local bus throughput can be up to 132MB/s. Of three PCI slots provided, all of them are master PCI slots with arbitration and decoding for all integrated functions and LPC bus. MX4SG-4DL / MX4SG-4DN / MX4SPB-N motherboard includes one AGP expansion slot for a bus mastering AGP graphic card. The [Accelerated Graphics Port \(AGP\)](#) specification provides a new level of video display sophistication and speed. The AGP video cards support data transfer rate up to 2112MB/s. For MX4SG-4DL / MX4SG-4DN, you may have ADD card cabled to this AGP slot to provide high-speed digital connection for digital displays.

AGP Protection Technology

With AGP Protection Technology implemented, this motherboard will automatically detect the voltage of AGP card and prevent your chipsets from being burnt out.

Hyper-Threading Technology

Support Hyper-Threading Technology which brings additional intelligence to systems so that multiple tasks received from the processor can be managed and prioritized more effectively.



Watch Dog ABS

Includes AOpen “Watch Dog ABS” function that can auto-reset system in 4.8 seconds when you fail the system overclocking.

1MHz Stepping CPU Frequency Adjustment

Provides “1MHz Stepping CPU Frequency Adjustment” function in the BIOS. This magic function allows you to adjust CPU FSB frequency from 100~255MHz by 1MHz stepping adjustment, and helps your system get maximum performance.

LAN Port

On the strength of Broadcom BCM5705 Gigabit LAN controller (MX4SG-4DL) or Broadcom BCM4401 LAN controller (MX4SG-4DN and MX4SPB-N) on board, this motherboard provides 10/100 Mbps Ethernet (for MX4SG-4DL, it is 10/100/1000 Mbps) for office and home use.

Ultra DMA 33/66/100 Bus IDE

Comes with an on-board PCI Bus Master IDE controller with two connectors that support four IDE devices in two channels, supports Ultra DMA 33/66/100, PIO Modes 3 and 4 and Bus Master IDE DMA Mode 5, and supports Enhanced IDE devices.

Serial ATA

Integrated in ICH5 that contains independent DMA operation on two ports, the SATA controllers are completely software transparent with the IDE interface, while providing a lower pin count and higher performance. The ICH5 SATA interface supports data transfer rates up to 150MB/s.

On-board AC'97 Sound

MX4SG-4DL / MX4SG-4DN / MX4SPB-N uses RealTek AC'97 CODEC RealTek ALC655 sound chip. This on-board audio includes a complete audio recording and playback system.

Eight USB 2.0 Ports

Provides four ports on the back panel and two USB 2.0 headers on the board, providing a total of eight USB 2.0 interface to connect devices such as mouse, keyboard, modem, scanner, etc.

S/PDIF Connector

S/PDIF (Sony/Philips Digital Interface) is the newest audio transfer file format, which provides impressive quality through optical fiber and allows you to enjoy digital audio instead of analog audio.

Power Management/Plug and Play

Supports the power management function which confirms to the power-saving standards of the U.S. Environmental Protection Agency (EPA) Energy Star program. It also offers [Plug-and-Play](#), which helps save users from configuration problems, thus making the system much user-friendlier.

Hardware Monitoring Management

Supports CPU or system fans status, temperature and voltage monitoring and alert, through the on-board hardware monitor module.

SilentTek

Combines “Hardware-Status Monitoring”, “Overheat Warning” and “Fan Speed Control” with user-friendly interfaces to provide a perfect balance among noises, system performance and stability.

Enhanced ACPI

Fully implement the [ACPI](#) standard for Windows® 98/ME/2000/XP series compatibility, and supports Soft-Off, STR (Suspend to RAM, S3), STD (Suspend to Disk, S4) and S5 features.

Quick Installation Procedure

This page gives you a quick procedure on how to install your system. Follow each step accordingly.

1. [Installing CPU and Fan](#)
2. [Installing System Memory \(DIMM\)](#)
3. [Connecting Front Panel Cable](#)
4. [Connecting IDE and Floppy Cable](#)
5. [Connecting ATX Power Cable](#)
6. [Connecting Back Panel Cable](#)
7. [Power-on and Load BIOS Setup Default](#)
8. [Setting CPU Frequency](#)
9. Reboot
10. Installing Operating System (such as Windows XP)
11. [Installing Driver and Utility](#)

Motherboard Map

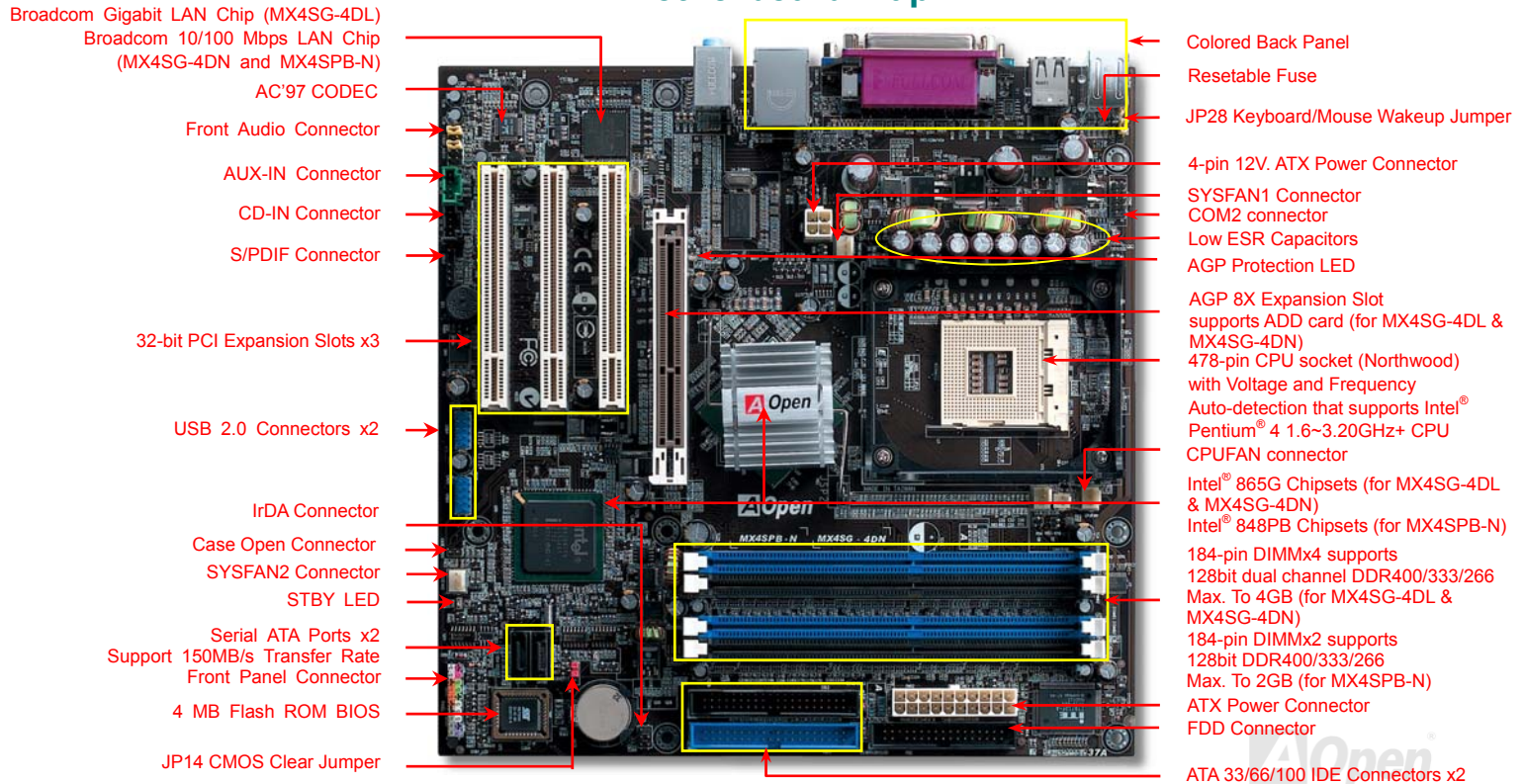

Block Diagram

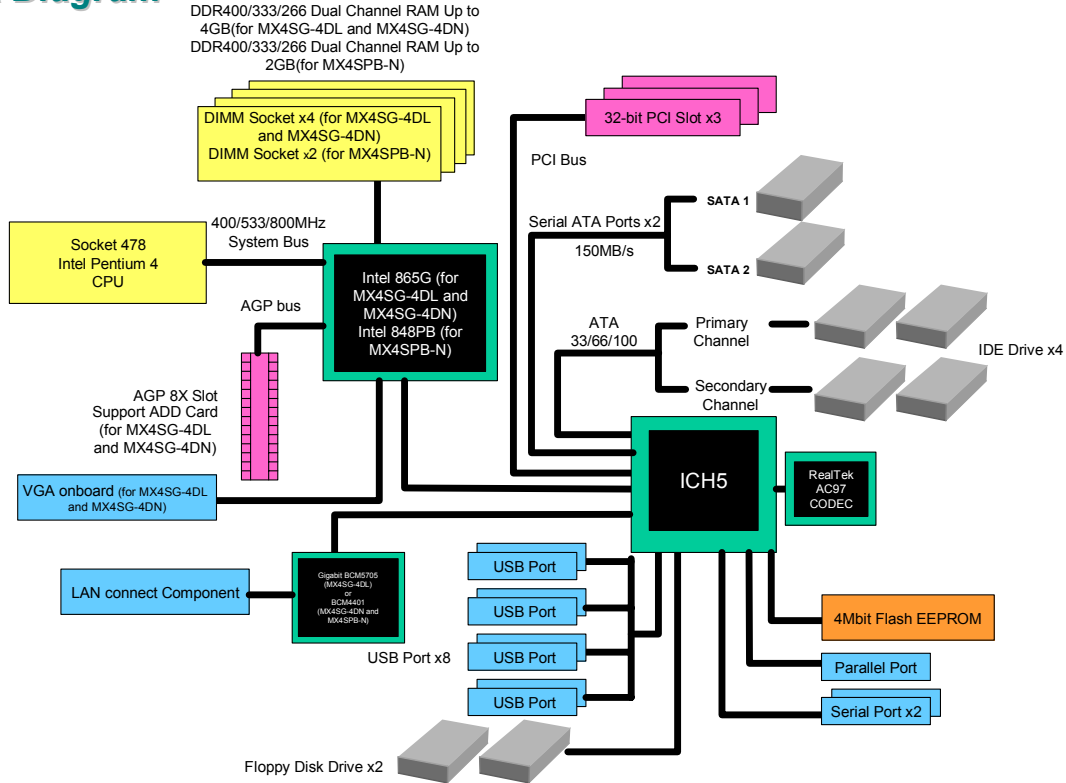

Hardware Installation

This chapter describes jumpers, connectors and hardware devices of this motherboard.



Note: *Electrostatic discharge (ESD) can damage your processor, disk drives, expansion boards, and other components. Always observe the following precautions before you install a system component.*

1. *Do not remove a component from its protective packaging until you are ready to install it.*
2. *Wear a wrist ground strap and attach it to a metal part of the system unit before handling a component. If a wrist strap is not available, maintain contact with the system unit throughout any procedure requiring ESD protection.*

About “User Upgrade Optional” and “Manufacture Upgrade Optional”...

When you read this online manual and start to assemble your computer system, you may notice that some of the functions are marked as “User Upgrade Optional” or “Manufacture Upgrade Optional”. Although all of AOpen’s motherboards have included many amazing and powerful features, sometimes not every user is familiar with these powerful features. As a result of this we define features that can be upgraded by users as “User Upgrade Optional”. You can upgrade these functions by purchasing additional devices. As for functions that cannot be upgraded by users, we define them as “Manufacture Upgrade Optional”. If need be, you can contact our local distributors or resellers to purchase “Manufacture Upgrade Optional” components, and again you are also welcome to visit our official website at english.aopen.com.tw for detail information.



JP14 Clear CMOS Data

You can clear CMOS to restore system default setting. To clear the CMOS, follow the procedure below.

1. Turn off the system and unplug the AC power.
2. Remove ATX power cable from connector PWR2.
3. Locate JP14 and short pins 2-3 for a few seconds.
4. Return JP14 to its normal setting by shorting pin1 & pin2.
5. Connect ATX power cable back to connector PWR2.

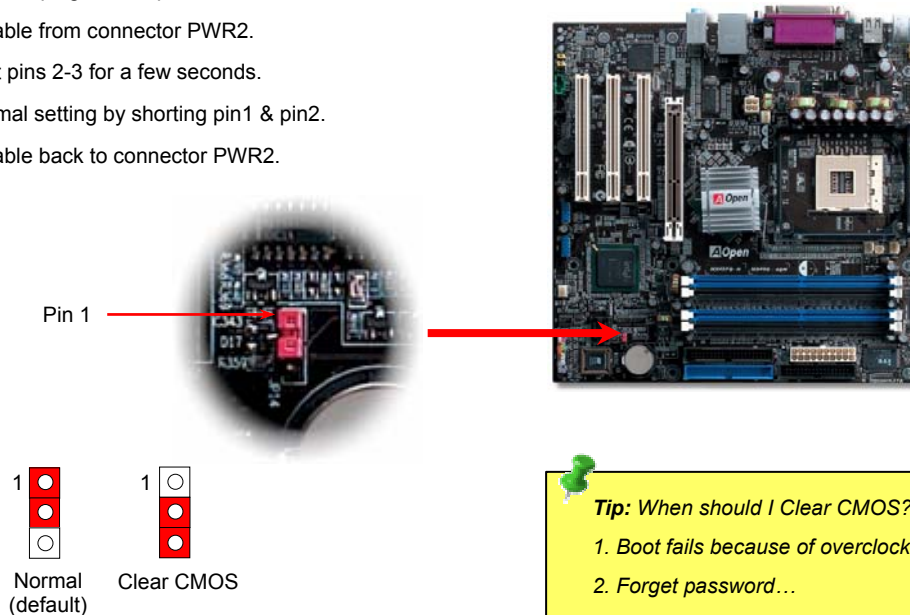

Tip: When should I Clear CMOS?

1. Boot fails because of overlocking...
2. Forget password...
3. Troubleshooting...

CPU Installation

This motherboard supports Intel® Pentium 4 Socket 478 series CPU (Northwood). Be careful of CPU orientation when you plug it into CPU socket.

1. Pull up the CPU socket lever and up to 90-degree angle.
2. Locate Pin 1 in the socket and look for mark on the CPU upper interface. Match Pin 1 and cut edge, then insert the CPU into the socket.

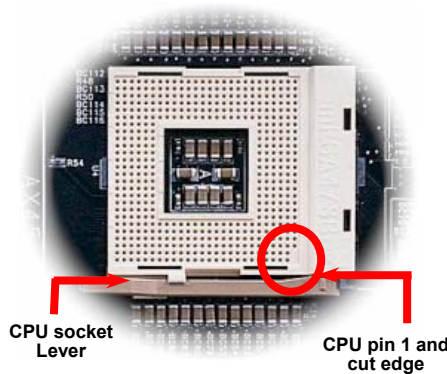
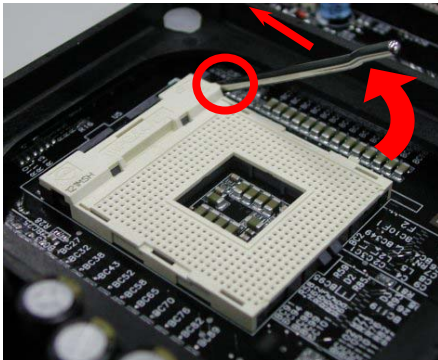

Note: Those pictures are for example only; they may not look the same with the motherboard you purchased.

- 3.** Press down the CPU socket lever and finish CPU installation.

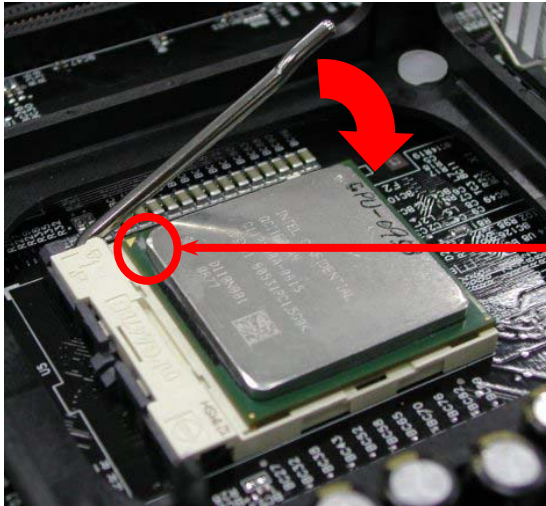

CPU cut edge

Note: If you do not match the CPU socket Pin 1 and CPU cut edge well, you may damage the CPU.

Note: This socket supports Micro-FC-PGA2 package CPU, which is the latest CPU package developed by Intel. Other forms of CPU package are impossible to be fitted in.

Note: This picture is for example only; it may not look the same with the motherboard you purchased.

CPU Fan Installation

This motherboard comes with a retention module attached on the CPU socket when shipped, we strongly recommend you to install AOpen special designed CPU Fan as shown below on the retention module for better heat dissipation. Please install the CPU Fan correctly as the following pictures shown.

1. Gently put the CPU Fan down on the retention module with clips aligning correctly to the four corners.
2. Pressing down the four clips with force one by one on the retention module.

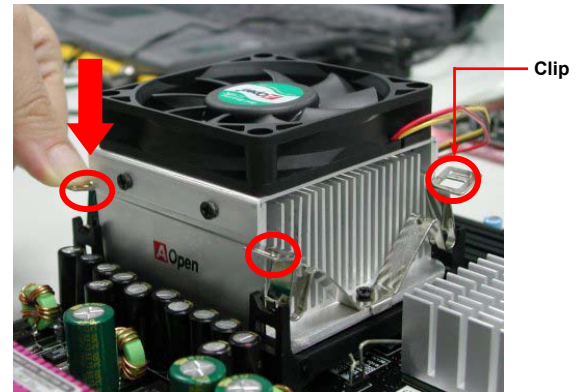
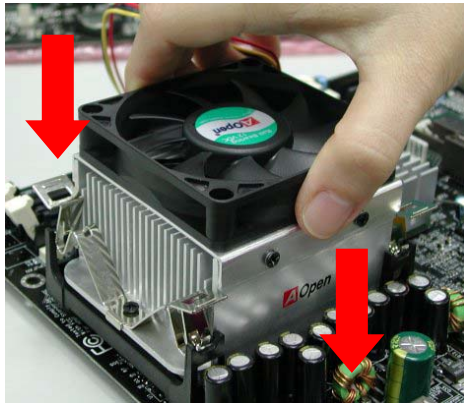

Note: The picture above may look different from the product you purchased.

CPU Jumper-less Design

CPU VID signal and [SMBus](#) clock generator provide CPU voltage auto-detection and allows the user to set the CPU frequency through the BIOS setup, therefore no jumpers or switches are used. The disadvantages of the Pentium based jumper-less designs are eliminated. There will be no worry of wrong CPU voltage detection.

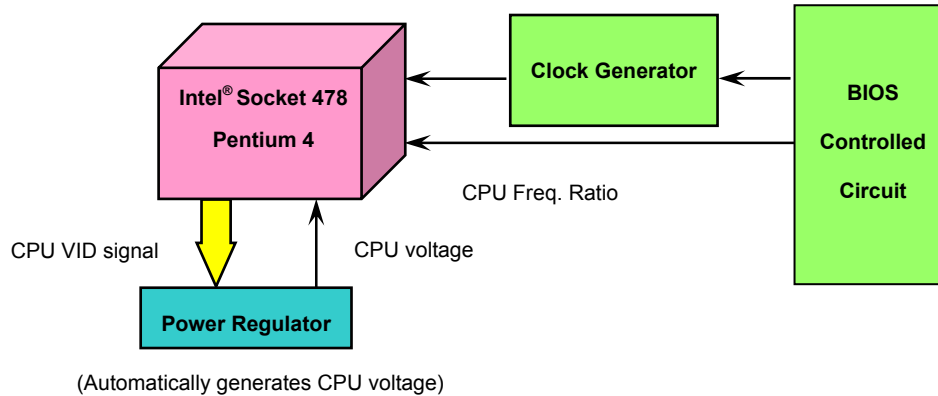

CPU Over-current Protection

The Over Current Protection is a popular implementation on ATX 3.3V/5V/12V switching power supply. However, the new generation CPU uses different voltage with a regulator to transfer 12V to CPU voltage (for example, 1.475V), and thus makes 5V over current protection useless. This motherboard is with switching regulator onboard supporting CPU over-current protection; in conjunction with 3.3V/5V/12V power supply provide the full line over-current protection.

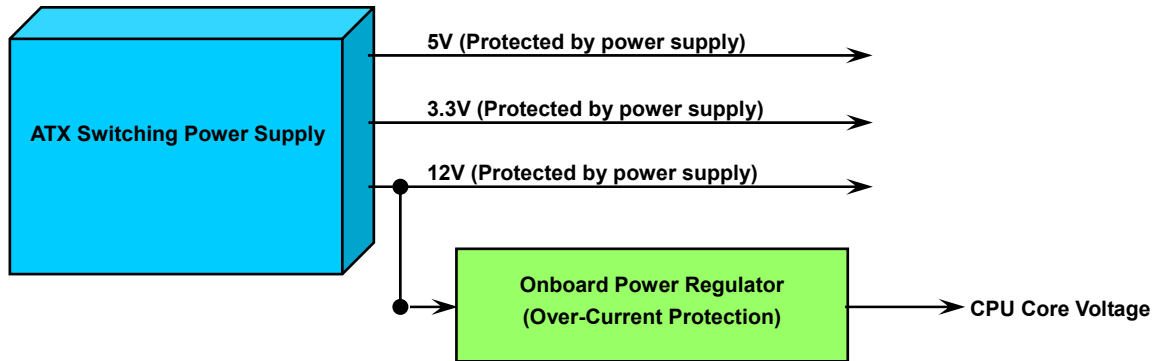

Note: Although we have implemented protection circuit try to prevent any human operating mistake, there is still certain risk that CPU, memory, HDD, add-on cards installed on this motherboard may be damaged because of component failure, human operating error or unknown nature reason. **AOpen cannot guaranty the protection circuit will always work perfectly.**

Battery-less and Long Life Design

This Motherboard implements a [Flash ROM](#) and a special circuit that provide you no batter power consumption of current CPU and CMOS Setup configurations. The RTC (real time clock) can also keep running as long as the power cord is plugged. If you lose your CMOS data by accident, you can just reload the CMOS configurations from Flash ROM and the system will recover as usual.

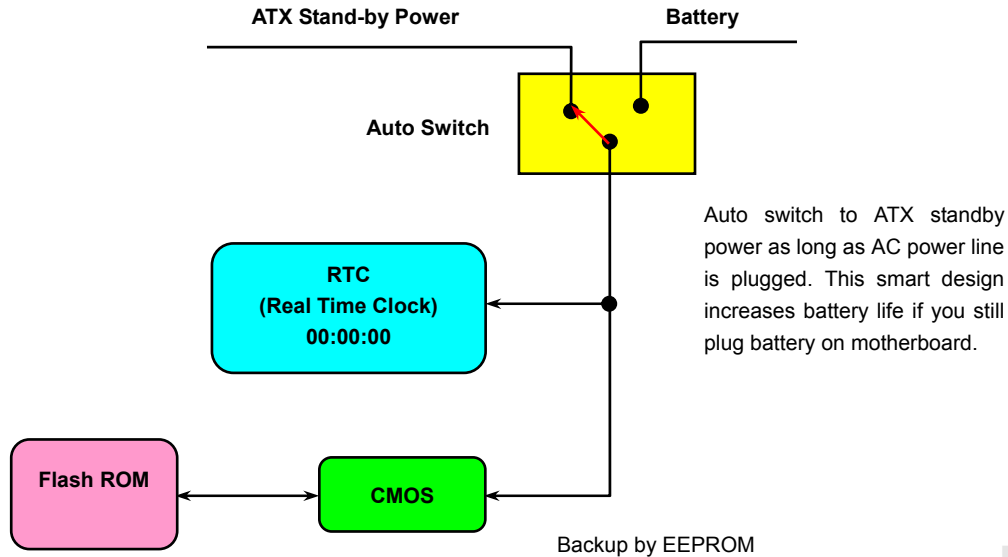

AOpen “Watch Dog ABS”



AOpen provides a special and useful feature on this motherboard for overclockers. When you power-on the system, the BIOS will check last system [POST](#) status. If it succeeded, the BIOS will enable “Watch Dog ABS” function immediately, and set the CPU FSB frequency according to user’s settings stored in the BIOS. If system failed in BIOS POST, the “Watch Dog Timer” will reset the system to reboot in five seconds. Then, BIOS will detect the CPU’s default frequency and POST again. With this special feature, you can easily overclock your system to get a higher system performance without removing the system housing and save the hassle from setting the jumper to clear CMOS data when system hangs.

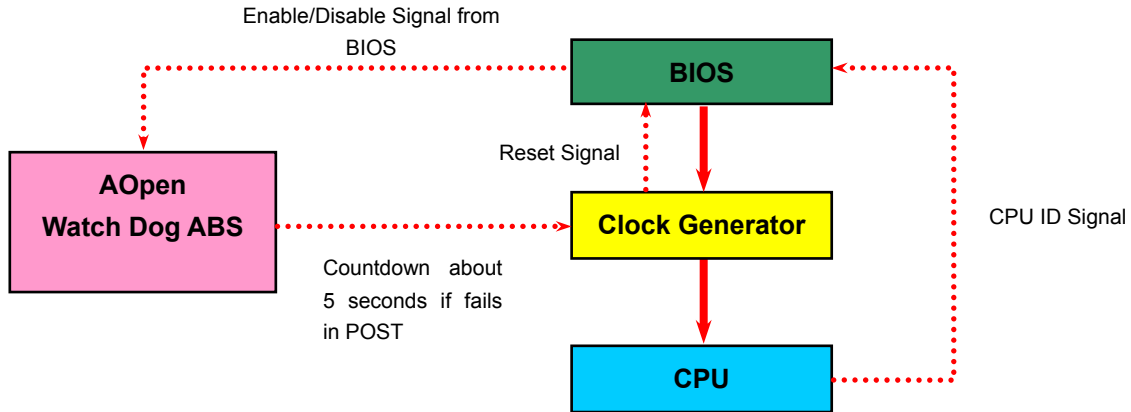

Full-range Adjustable CPU Core Voltage

This motherboard supports CPU VID function. The CPU core voltage will be automatically detected and the range is from 0.8375V to 1.6000V. It is not necessary to set CPU Core Voltage.

Setting CPU Frequency

BIOS Setup > Frequency/Voltage Control > CPU Bus Frequency

This motherboard is CPU jumper-less design, you can set CPU frequency in BIOS; no jumpers or switches are needed. The default setting is "table select mode". You can adjust the FSB from "CPU Host/RAM/PCI Clock" for overclocking.

$$\text{Core Frequency} = \text{CPU FSB Clock} * \text{CPU Ratio}$$

$$\text{PCI Clock} = \text{CPU FSB Clock} / \text{Clock Ratio}$$

$$\text{AGP Clock} = \text{PCI Clock} * 2$$

CPU Ratio	8x, 10x... 25x, 26x, 27x, 28x
CPU FSB (By BIOS table)	100-255MHz

Northwood CPU	CPU Core Frequency	FSB Clock	System Bus	Ratio
Pentium 4 1.7G	1700MHz	133MHz	533MHz	13x
Pentium 4 1.8G	1800MHz	100MHz	400MHz	18x
Pentium 4 2.0G	2000MHz	100MHz	400MHz	20x
Pentium 4 2.2G	2200MHz	100MHz	400MHz	22x
Pentium 4 2.2G	2200MHz	133MHz	533MHz	16x
Pentium 4 2.26G	2260MHz	133MHz	533MHz	17x
Pentium 4 2.4G	2400MHz	100MHz	400MHz	24x
Pentium 4 2.4G	2400MHz	133MHz	533MHz	18x
Pentium 4 2.53G	2530MHz	133MHz	533MHz	19x
Pentium 4 2.6G	2600MHz	200MHz	800MHz	13x
Pentium 4 2.66G	2660MHz	133MHz	533MHz	20x
Pentium 4 2.8G	2800MHz	133MHz	533MHz	21x
Pentium 4 2.8G	2800MHz	200MHz	800MHz	14x
Pentium 4 3.06G	3066MHz	133MHz	533MHz	23x
Pentium 4 3.20G	3200MHz	200MHz	800MHz	16x

Note: With CPU speed changing rapidly, there might be fastest CPU on the market by the time you received this installation guide. This table is kindly for your references only.

Note: Intel 865G chipset and Intel 848PB chipset only support Northwood processors. Northwood processors would detect the clock ratio automatically; you may not be able to adjust the clock ratio in BIOS manually.

Warning: Intel 865G chipset and Intel 848PB chipset support maximum 800MHz (200MHz*4) system bus and 66MHz AGP clock; higher clock setting may cause serious system damage.



CPU and System Fan Connector (with H/W Monitoring)

Plug in the CPU fan cable to the 3-pin **CPUFAN** connector. If you have chassis fan, you can also plug it on **SYSFAN1** or **SYSFAN2** connector.

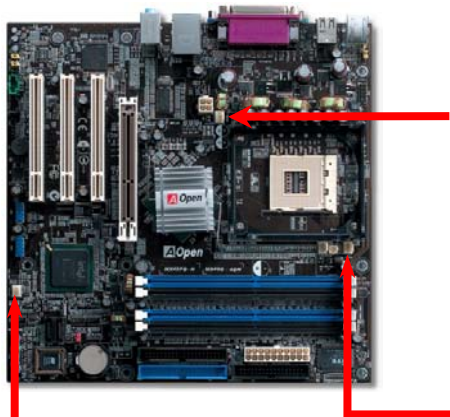

SYSFAN1 Connector

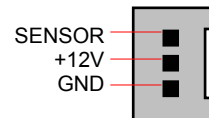

CPUFAN Connector

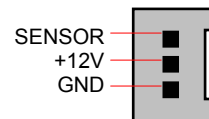

SYSFAN2 Connector

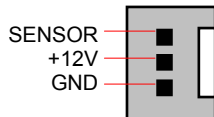

Note: Some CPU fans do not have sensor pin, so that they cannot support hardware monitoring function.



JP28 Keyboard/Mouse Wake-up Jumper

This motherboard provides PS2 keyboard / mouse wake-up function. You can use JP28 to enable or disable this function, which could resume your system from suspend mode with keyboard or mouse. The factory default setting is set to "Disable" (1-2), and you may enable this function by setting the jumper to 2-3.

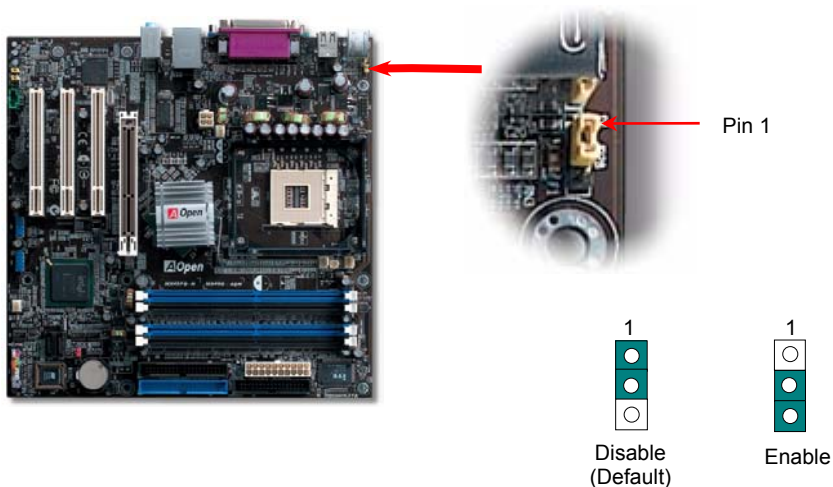

DIMM Sockets

MX4SG-4DL and MX4SG-4DN have four 184-pin DDR DIMM sockets that allow you to install 128-bit dual channel [DDR400](#), [DDR333](#) or [DDR266](#) memory up to 4GB. MX4SPB-N has two 184-pin DDR DIMM sockets that allow you to install 128-bit [DDR400](#), [DDR333](#) or [DDR266](#) memory up to 2GB. Only non-ECC DDR SDRAM is supported. Please install suitable modules; otherwise serious damage may occur on memory sockets or your RAM modules. **Please note that when you install DDR333 memory module and have your CPU FSB set at 800MHz, the memory can only run with the speed of DDR320. It is limitation of Intel.** For other limitation of CPU types, please see the table below.

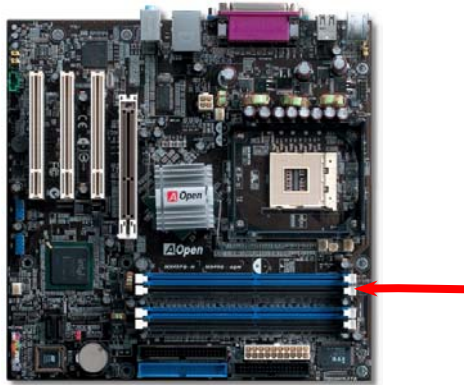

Item	DDR266	DDR333	DDR400
CPU FSB 400MHz	✓	✗	✗
CPU FSB 533MHz	✓	✓	✗
CPU FSB 800MHz	✓	⊖	✓



DIMMA1
DIMMA2
DIMMB1
DIMMB2

Warning: This motherboard supports DDR SDRAM. Please do not install the SDRAM on the DDR SDRAM sockets; otherwise it will cause serious damage on memory sockets or SDRAM module.

Note: To run dual channel speed, you have to use the same type memory modules installed on two DIMMs. If you install two different sized modules, the system can only run single channel mode and with the speed of that lower memory module.

How to Install Memory Modules

Please follow the procedure as shown below to finish memory installation.

1. Make sure the DIMM module's pin face down and match the socket's size as depicted below.

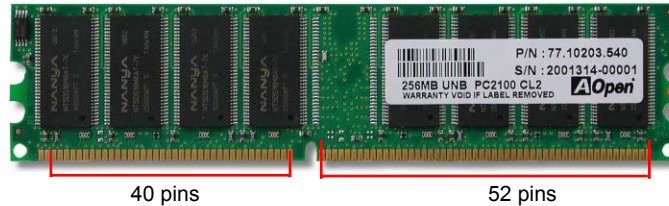

Note: Please pay attention to the Blue slots. To run dual channel speed, you should insert the RAM in the slot of DIMM A1 and DIMM B1 or DIMM A2 and DIMM B2. Please don't use the different frequency DIMM on dual channel

2. Insert the module straight down to the DIMM slot with both hands and press down firmly until the DIMM module is securely in place.

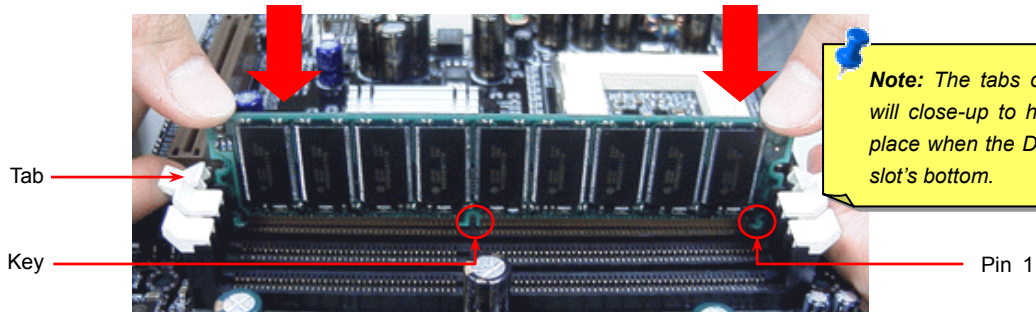

Note: The tabs of the DIMM slot will close-up to hold the DIMM in place when the DIMM touches the slot's bottom.

3. Repeat step 2 to finish additional DIMM modules installation.

Note: These images are for example only; they may not be exactly the same as the motherboard you purchased.

ATX Power Connector

This motherboard comes with a 20-pin and 4-pin ATX power connector. Make sure you plug in the right direction. We strongly recommend you to connect the 4-pin 12V ATX connector before connecting the 20-pin ATX power connector and use standard power supply specially designed for Pentium 4 system.

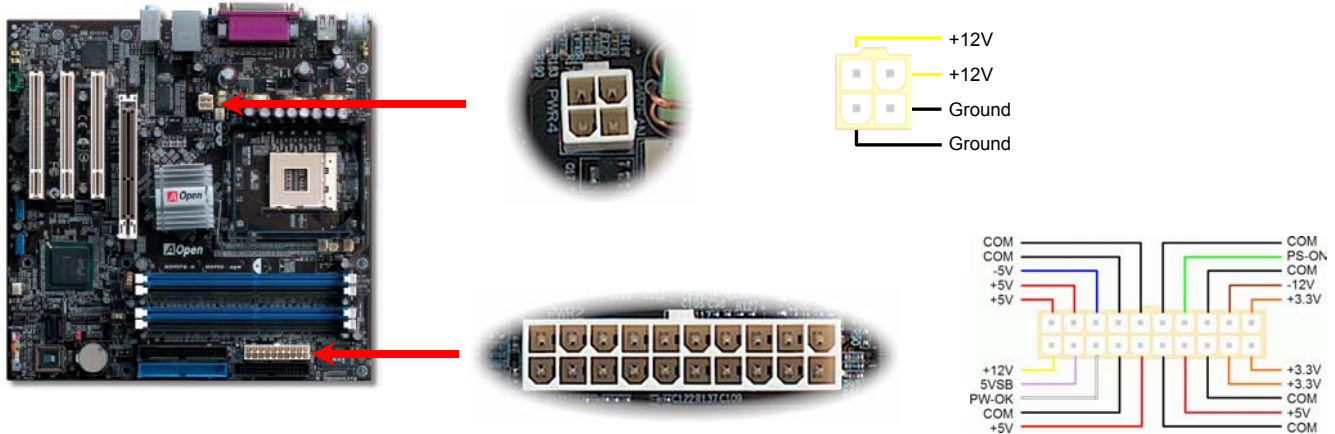

AC Power Auto Recovery

A traditional ATX system should remain at power off stage when AC power resumes from power failure. This design is inconvenient for a network server or workstation, without an UPS, that needs to keep power-on. This motherboard implements an AC Power Auto Recovery function to solve this problem.



IDE and Floppy Connector

Connect 34-pin floppy cable and 40-pin IDE cable to floppy connector FDD and IDE connector. Be careful of the pin1 orientation. Wrong orientation may cause system damage.

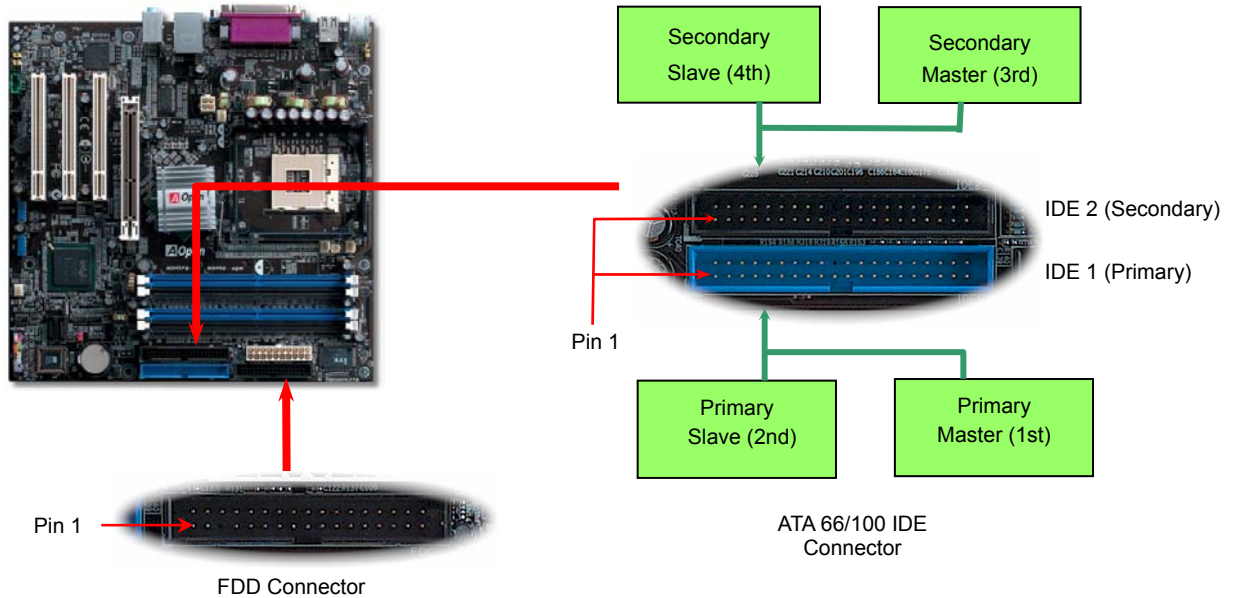

IDE1 is also known as the primary channel and IDE2 as the secondary channel. Each channel supports two IDE devices that make a total of four devices. In order to work together, the two devices on each channel must be set differently to **Master** and **Slave** mode. Either one can be the hard disk or the CDROM. The setting as master or slave mode depends on the jumper on your IDE device, so please refer to your hard disk and CDROM manual accordingly.

**Tip:**

1. *For better signal quality, it is recommended to set the far end side device to master mode and follow the suggested sequence to install your new device. Please refer to above diagram*
2. *To achieve the best performance of Ultra DMA 66/100 hard disks, a special **80-wires IDE cable** for Ultra DMA 66/100 is required.*



Warning: *The specification of the IDE cable is a maximum of 46cm (18 inches); make sure your cable does not exceed this length.*

Serial ATA Supported

NEW!

The traditional parallel ATA specification has defined the standard storage interface for PCs with its original speed of just 3 Mbytes/second since the protocol was introduced in the 1980s. And the latest generation of the interface, Ultra ATA-133, has been developed further with a burst data transfer rate of 133 Mbytes/second. However, while ATA has enjoyed an illustrious track record, the specification is now showing its age and imposes some serious design issues on today's developers, including a 5-volt signaling requirement, high pin count, and serious cabling headaches.

The Serial ATA specification is designed to overcome these design limitations while enabling the storage interface to scale with the growing media rate demands of PC platforms. Serial ATA is to replace parallel ATA with the compatibility with existing operating systems and drivers, adding performance headroom for years to come. It reduces voltage and pins count requirements and can be implemented with thin and easy to route cables.

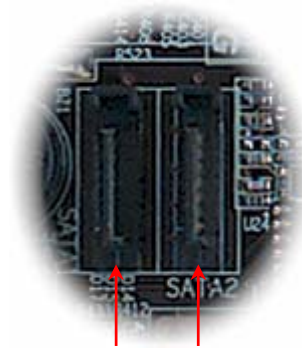
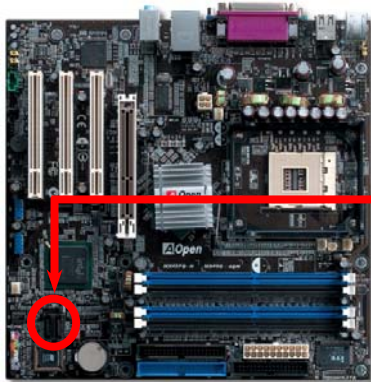

Serial ATA Ports

SATA port 1 SATA port 2



Connecting Serial ATA Disk

To connect a Serial ATA disk, you have to have a 7-pin serial ATA cable. Connect two ends of the serial ATA cable to the serial ATA header on the motherboard and the disk. Like every other traditional disk, you also have to connect a power cable. Please be noted that it is a jumper free implement; you don't need to set jumpers to define a master or slave disk. When serial ATA hard disks are installed on serial ATA ports, the one connected on Port 0(SATA 1) will be set as the first boot device automatically. Please be noted that it doesn't support Hot-Plug in function.



Item	Parallel ATA	Serial ATA
Bandwidth	100/133 MB/Sec	150/300/600 MB/Sec
Volts	5V	250mV
Pins	40	7
Length Limitation	18 inch (45.72cm)	1 meter (100cm)
Cable	Wide	Thin
Ventilation	Bad	Good
Peer-to-Peer	No	Yes

Comparison between Parallel ATA and Serial ATA

Adjusting Your Hard Disk

Except its original 2 sets of parallel IDE, this motherboard does come with the support for the latest Serial ATA hard disk. If you are unable to find your newly installed Serial ATA hard disks on your operating system after you have had installed them on, the problem mainly lies in the BIOS setting. You may simply adjust BIOS settings to have them work properly.

After having properly installed your hard disks, you may directly get into the BIOS setting screen for adjustment. You may simply press “Integrated Peripherals → On-Chip IDE Device → On-Chip Serial ATA” to choose your preferable mode. If you have no intention of changing its setting, the default would be Auto.

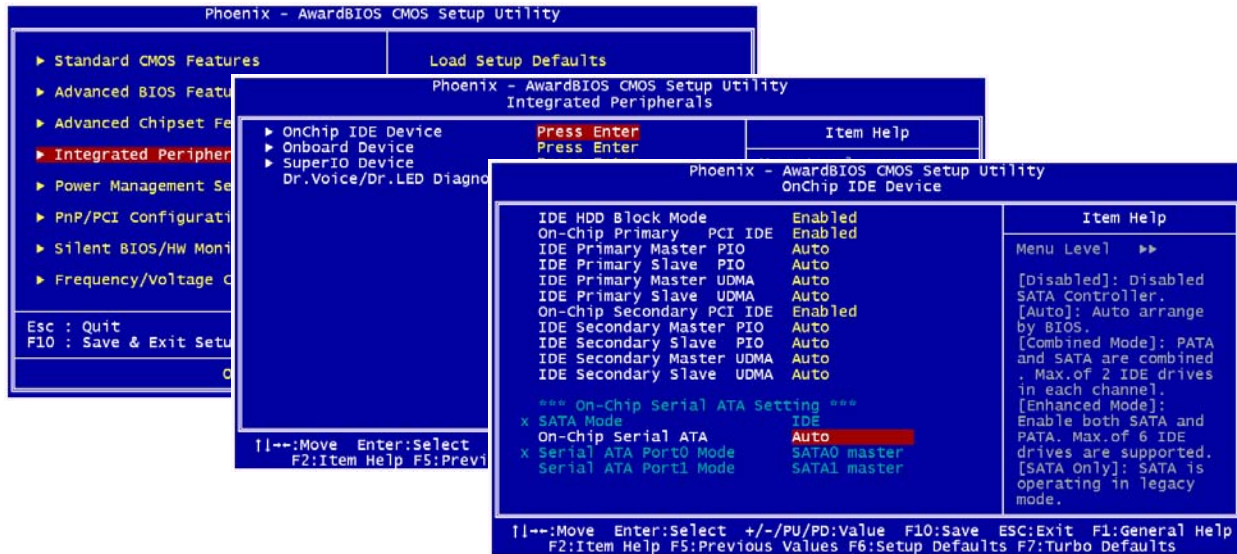

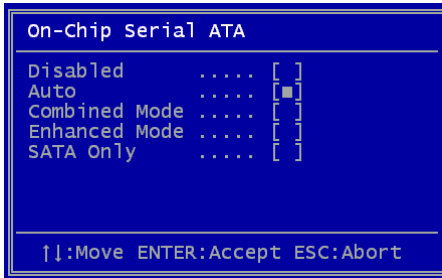

If you intend to change the default setting, simply press **Enter** for a list of selection:

1. **Disabled:** You may choose this item if you're sure that only traditional IDE hard disks had been installed on your system. Disabling this item may also cancel the detection to Serial ATA hard disk during POST, which theoretically, could speed up your boot-up timing for a little bit; however, please remember to re-adjust the settings here if you intend to use Serial ATA hard disk later.
2. **Auto:** This is the default setting upon receipt of the motherboard. Basically, if your system functions properly, it's not necessary to change it. The system will automatically recognize the first hard disk on IDE1 as the first boot device.

Note: Please be informed that when you are using Windows98/ME with six hard disks fully installed, Auto mode is not able to function properly, it's just because Windows98/Me is not able to energize Enhanced Mode to detect all hard disks.

3. **Combined Mode:** If you have had installed traditional IDE hard disks and Serial ATA hard disks at the same time, then you may choose this Combined Mode. Under this mode, you may randomly choose either IDE hard disks or Serial ATA had disk as your first boot device. But please be aware that Serial ATA will exist with IDE in a mapping way, which also means it will occupy one of the IDE Channel and left you with one IDE Channel only.
4. **Enhanced Mode:** If you are using the latest operating system (say, Windows XP, Windows.NET Server), it is highly recommended to select Enhanced Mode. The system would be able to detect all six devices (traditional IDE x4, Serial ATA x 2) completely and functions perfectly under this mode. But please be noted that it is defaulted with using traditional IDE as the first boot device.
Note: From our practical lab tests, we found no obvious problem or mistakes happened under Windows2000 operating system, but, however, it is not within the regulation recommended by Intel.
5. **SATA Only:** You may select this SATA Only mode if you have had installed Serial ATA hard disks only. It also allows you to select booting sequence from Port0 (SerialATA1) or Port1 (SerialATA2).

Front Panel Connector

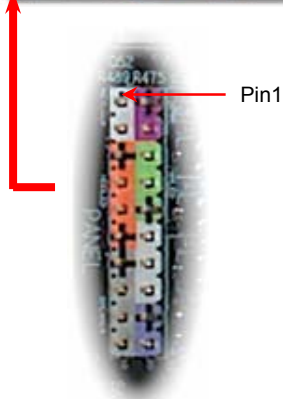

Attach the power LED, Keylock, speaker, power and reset switch connectors to the corresponding pins. If you enable "Suspend Mode" item in BIOS Setup, the ACPI & Power LED will keep flashing while the system is in suspend mode.

Locate the power switch cable from your ATX housing. It is 2-pin female connector from the housing front panel. Plug this connector to the soft-power switch connector marked **SPWR**.

Suspend Type	ACPI LED
Power on Suspend (S1) or Suspend to RAM (S3)	Flashing for every second
Suspend to Disk (S4)	The LED will be turned off

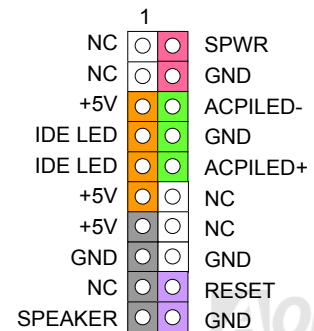
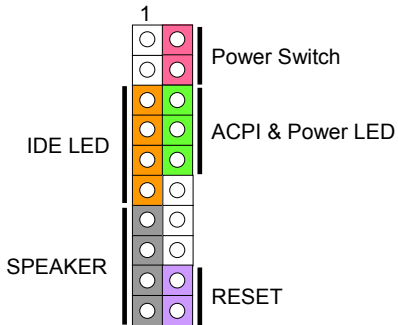

AGP (Accelerated Graphic Port) 8X Expansion Slot

MX4SG-4DL / MX4SG-4DN / MX4SPB-N provides an [AGP](#) 8X slot. The AGP 8X is a bus interface targeted for high-performance 3D graphic. AGP uses both rising and falling edge of the 66MHz clock, for 4X AGP, the data transfer rate is $66\text{MHz} \times 4\text{bytes} \times 4 = 1056\text{MB/s}$. AGP is now moving to AGP 8X mode, which is For MX4SG-4DL / MX4SG-4DN, this AGP slot could automatically become an AGP slot or a Multiplexed Intel DVO Output depending on what kind of cards inserted, like AGP, or ADD (AGP Digital Display) cards. With ADD card cabled to this slot, Multiplexed Intel DVO output could provide high-speed digital connection for digital displays or TV-OUT functionality. You can also adjust AGP voltage in BIOS within a range from 1.5V to 1.6V.

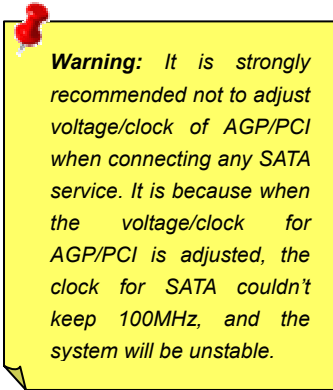

AGP Protection Technology and AGP LED

With the outstanding R&D ability of AOpen and its specially developed circuit, this motherboard implements a brand new technology to protect your motherboard from being damaged by over-volting of AGP card. When AGP Protection Technology is implemented, this motherboard will automatically detect the voltage of AGP card and prevent your chipsets from being burnt out. Please note that if you install a AGP card with 3.3V, which is not supported by Intel 865 chipset, the AGP LED on the motherboard will light up to warn you the possible damage of the exceeding voltage. You may contact your AGP card vendor for further support.

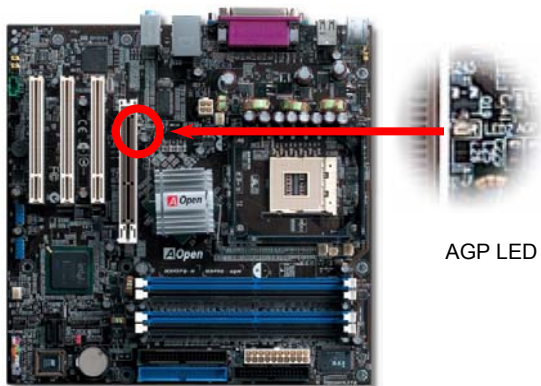

AGP LED

Warning: It is strongly recommended not to install a 3.3V AGP card, which is not supported by Intel 865 chipset. When you do so, the AGP LED on the motherboard will light up to warn you the possible damage.

IrDA Connector

The IrDA connector can be configured to support wireless infrared module, with this module and application software such as Laplink or Windows 98 Direct Cable Connection, the user can transfer files to or from laptops, notebooks, PDA devices and printers. This connector supports HPSIR (115.2Kbps, 2 meters) and ASK-IR (56Kbps).

Install the infrared module onto the **IrDA** connector and enable the infrared function from BIOS Setup, UART Mode, make sure to have the correct orientation when you plug in the IrDA connector.

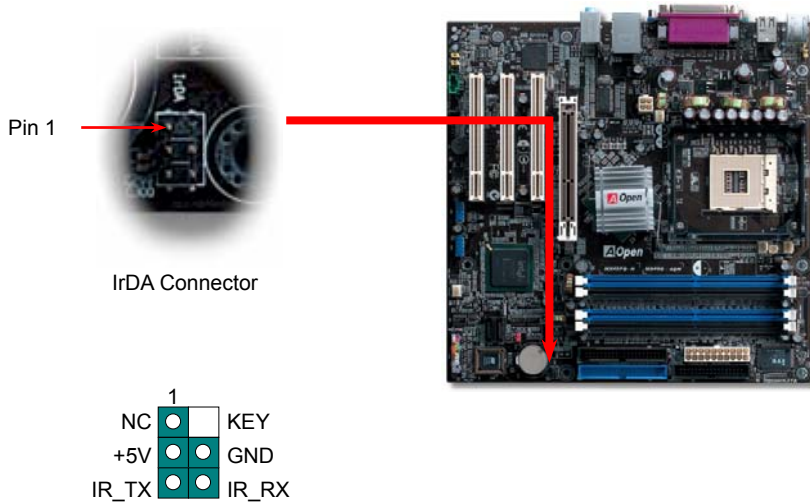

Support 10/100/1000 Mbps LAN onboard

On the strength of Broadcom Gigabit LAN controller (MX4SG-4DL) or Broadcom BCM4401 LAN controller (MX4SG-4DN and MX4SPB-N) on board, this motherboard provides 10/100 Mbps Ethernet (for MX4SG-4DL, it is 10/100/1000 Mbps) for office and home use. The Ethernet RJ45 connector is located on top of USB connectors. The right hand side LED indicates link mode, it lights in orange whenever linking to network. The left hand side LED indicates the transfer mode and it lights in green when data is transferring in 100Mbps (never lights while in 10Mbps), but lights in orange when transferring in Gigabit's mode (MX4SG-4DL). To enable or disable this function, you may simply adjust it through BIOS.

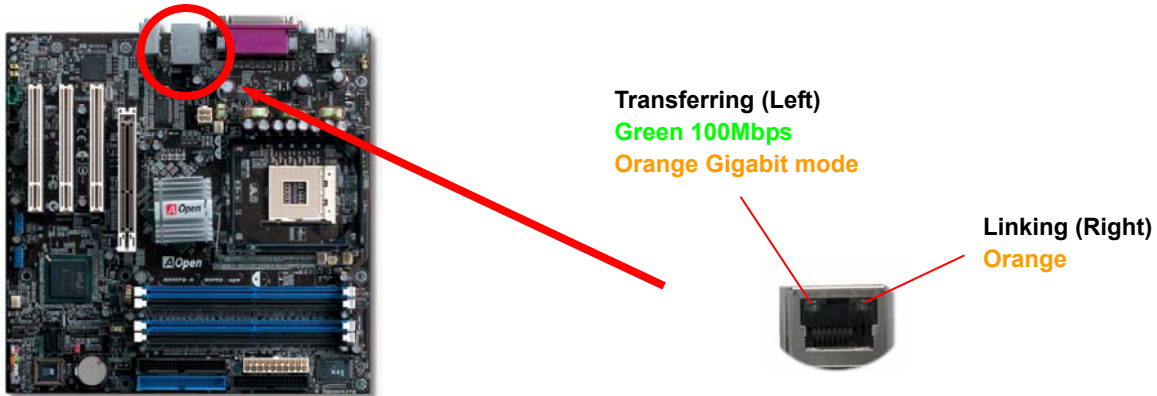

Support USB 2.0 Ports

This motherboard provides eight [USB 2.0](#) ports to connect USB devices such as mouse, keyboard, modem, printer, etc. There are two USB headers on the board for you to connect two USB devices and four other ports on the back panel. You can use proper cables to connect USB devices from back panel or connect the front USB connector to the front panel of chassis.

Compared to traditional USB 1.0/1.1 with the speed of 12Mbps, USB 2.0 has a fancy speed up to 480Mbps that is 40 times faster than the traditional one. Except for the speed increase, USB 2.0 supports old USB 1.0/1.1 software and peripherals, offering impressive and even better compatibility to customers. On this motherboard, all eight ports support USB 2.0 function.

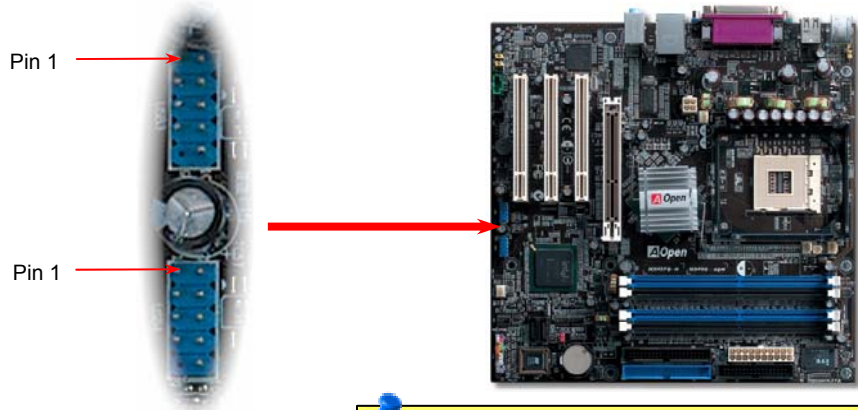
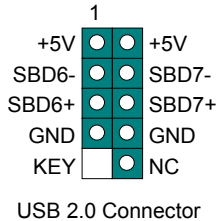

Note: Please note that if you would like to use USB devices (Example: keyboard, mouse etc.) under DOS environment, you must install driver that comes with the devices to make it work.

Color Coded Back Panel

The onboard I/O devices are PS/2 Keyboard, PS/2 Mouse, RJ-45 LAN Connector, COM1, VGA port, Printer, USB, AC'97 sound and game ports. The view angle of drawing shown here is from the back panel of the housing.

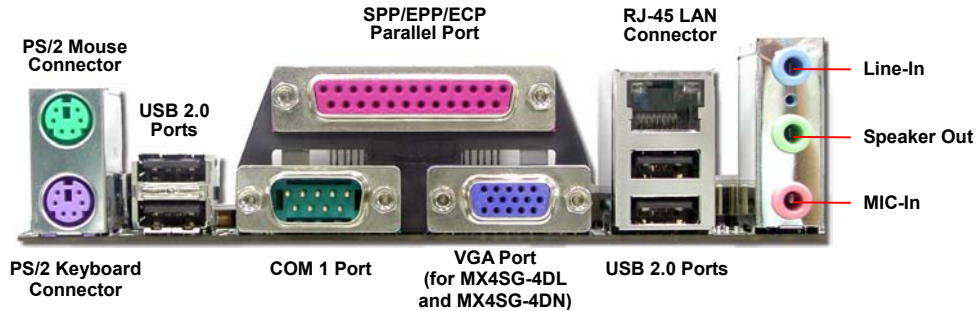

PS/2 Keyboard:	For standard keyboard, which use a PS/2 plug.
PS/2 Mouse:	For PC-Mouse, which use a PS/2 plug.
USB Port:	Available for connecting USB devices.
Parallel Port:	To connect with SPP/ECP/EPP printer.
COM1 Port:	To connect with pointing devices, modem or others serial devices.
RJ-45 LAN connector	To connect Ethernet for home or office use.
VGA Connector:	To connect with PC monitor.
Speaker Out:	To External Speaker, Earphone or Amplifier.
Line-In:	Comes from the signal sources, such as CD/Tape player.
MIC-In:	From Microphone.



S/PDIF (Sony/Philips Digital Interface) Connector

S/PDIF (Sony/Philips Digital Interface) is a latest audio transfer file format that provides impressive quality through optical fiber and allows you to enjoy digital audio instead of analog. Normally there are two S/PDIF outputs as shown, one for RCA connector, the most common one used for consumer audio products, and the other for optical connector with a even better audio quality. Through a specific audio cable, you can connect the S/PDIF connector to a S/PDIF audio module bearing S/PDIF digital output. However, you must have a S/PDIF supported speaker with S/PDIF digital input to make the most of this function.

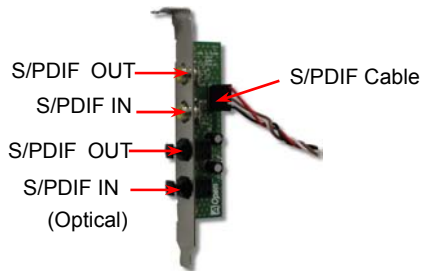

S/PDIF Module
(User Upgrade Optional)

Pin 1



S/PDIF Connector

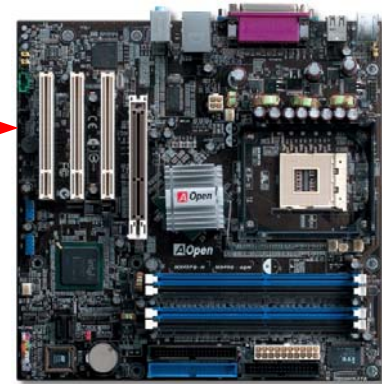

- | | | |
|---|---|----------|
| 1 | + | +5V |
| | | NC |
| | + | SPDIFOUT |
| | | GND |
| 5 | + | SPDIFIN |

Super 5.1 Channel Audio Effect

NEW!

This motherboard comes with an ALC655 CODEC, which supports high quality of 5.1 Channel audio effects, bringing you a brand new audio experience. On the strength of the innovative design of ALC655, you're able to use standard line-jacks for surround audio output without connecting any external module. To apply this function, you have to install the audio driver in the Bonus Pack CD as well as an audio application supporting 5.1 Channel. Picture bellow represents the standard location of all speakers in 5.1 Channel sound tracks. Please connect the plug of your front speakers to the green "Speaker out" port, rear speakers' plug to the blue "Line in" port and both of the center and subwoofer speakers to the red "MIC in" port.

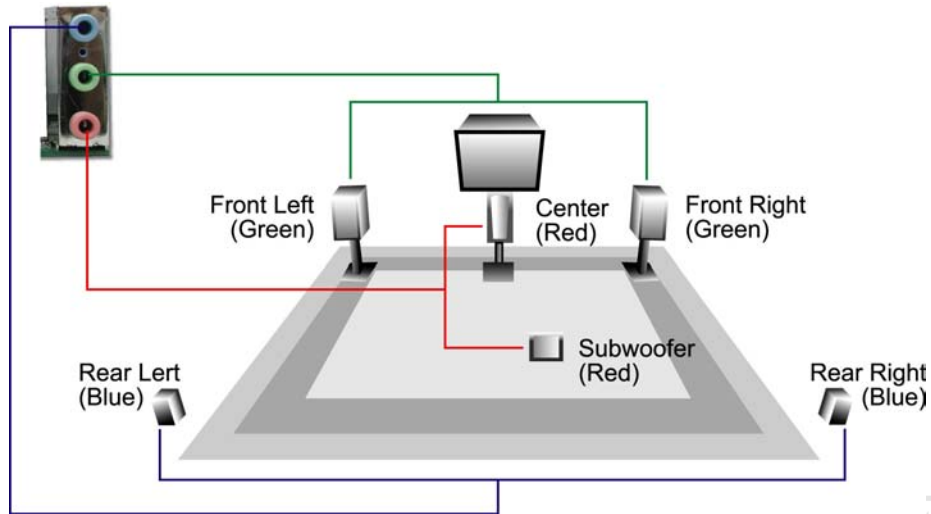

Wake On Modem / Wake On LAN / Wake On PCI Card

This motherboard implements special circuit to support Wake On Modem, Wake On LAN and Wake On PCI Card.

Green PC suspend mode does not really turn off the system power supply, it can be triggered by Modem, LAN or Other PCI Cards and resume back to active. If you have an external Modem card and want to use this wake-up feature, Please enable the "Wake On Modem" item. For an internal modem, LAN and other PCI cards, please enable the "Wake On PCI Card" item.

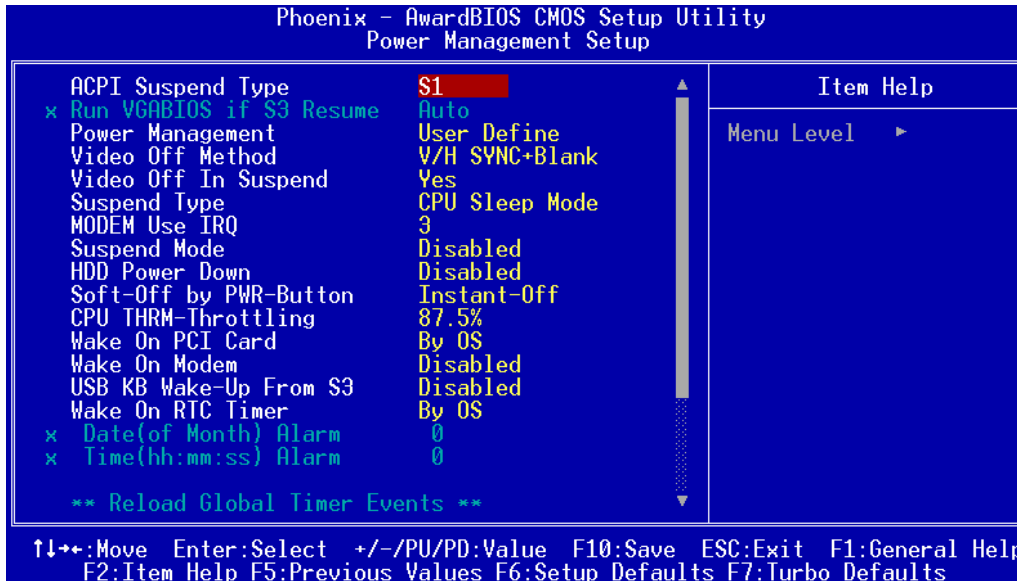

Front Audio Connector

If the housing has been designed with an audio port on the front panel, you'll be able to connect onboard audio to front panel through this connector. By the way, please remove the jumper cap from the Front Audio Connector before you connect the cable. Do not remove this yellow jumper cap if your housing doesn't have an audio port on the front panel.

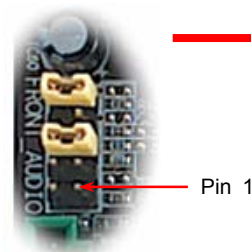

AUD_RET_L	<input checked="" type="checkbox"/>	AUD_FPOUT_L
KEY	<input type="checkbox"/>	NC
AUD_RET_R	<input checked="" type="checkbox"/>	AUD_FPOUT_R
AUD_VCC	<input checked="" type="checkbox"/>	AUD_MIC_BIAS
AUD_GND	<input checked="" type="checkbox"/>	AUD_MIC

Front Audio Connector

1

Note: Please remove the jumper cap from the front audio connector before you connect the cable. Do not remove this yellow jumper cap if your housing doesn't have an audio port on the front panel.

CD Audio Connector

This connector is used to connect CD Audio cable from CDROM or DVD drive to onboard sound.

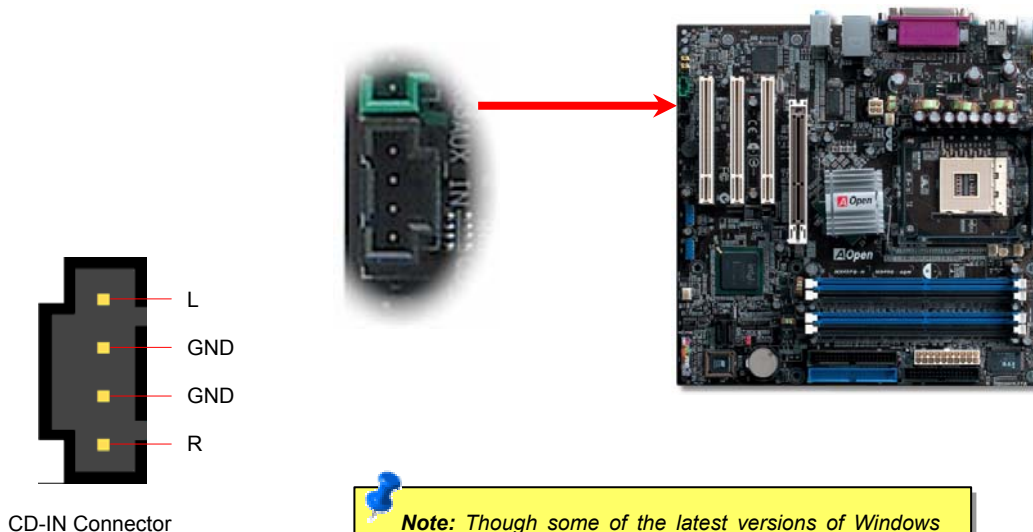

Note: Though some of the latest versions of Windows support "Digital Audio" through IDE bus. However, in order to use Open Jukebox player, which is driven under BIOS, it is a **MUST** to connect audio cable to CD-IN connector on the motherboard.

AUX-IN Connector

This connector is used to connect MPEG Audio cable from MPEG card to onboard sound.

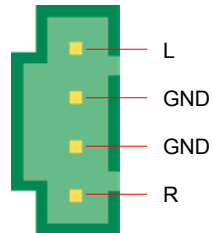

AUX-IN Connector



COM2 Connector

This motherboard provides two serial ports. One of them is on back panel connector, and the other is on the upper left of board. With proper cable, you can connect it to the back panel of chassis.

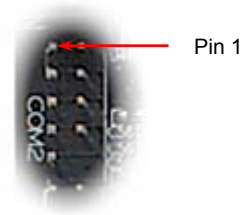

	1	2	
DCD#	●	●	SIN
SOUT	●	●	DTR#
GND	●	●	DSR#
RI#	●	●	CTS#
RTS#	●	□	

COM2 Connector

Case Open Connector

The “CASE OPEN” header provides chassis intrusion-monitoring function. To make this function works, you have to enable it in the system BIOS, connect this header to a sensor somewhere on the chassis. So, whenever the sensor is triggered by lights or by the opening of the chassis, the system will beep to inform you. Please be informed that this useful function only applies to advanced chassis, you may purchase an extra sensor, attach it on your chassis, and make a good use of this function.

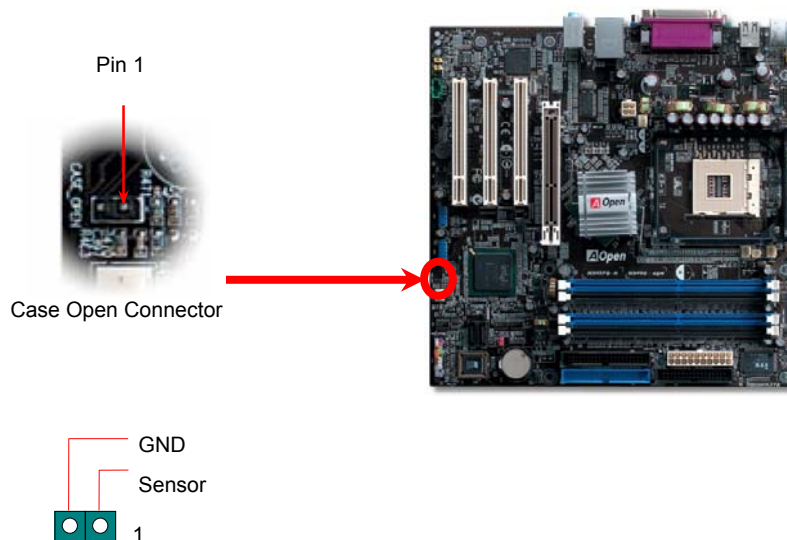

Resettable Fuse

Traditional motherboard uses fuses to prevent Keyboard and USB port from over-current or shortage. These fuses are soldered onboard that when it is broken (function to protect motherboard), user cannot replace them and result in malfunction of motherboard.

With expensive Resettable Fuse, the motherboard can be resumed back to normal function even after the fuse had done its protection job.

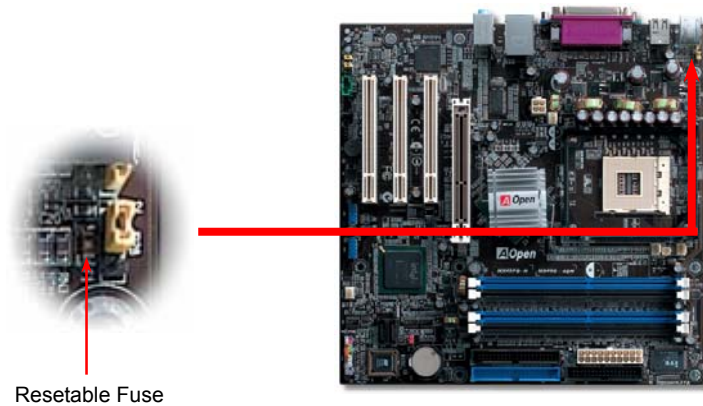

Resettable Fuse

Enlarged Aluminum Heatsink

Cool down CPU and Chipset are important for system reliability. Enlarged aluminum heat sink provides better heat consumption especially when you are trying to over-clock the CPU.

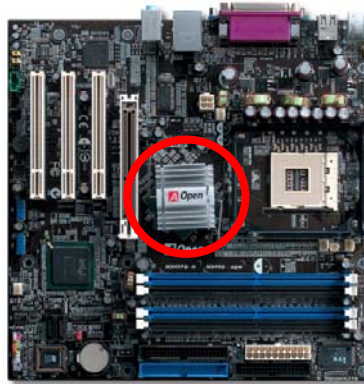

Low ESR Capacitor

The quality of low ESR capacitor (Low Equivalent Series Resistance) during high frequency operation is very important for the stability of CPU power. The idea of where to put these capacitors is another know-how that requires experience and detail calculation.

Not only that, MX4SG-4DL / MX4SG-4DN / MX4SPB-N implements 2200 μF capacitors, which is much larger than normal capacitor (1000 & 1500 μF) and it provides better stability for CPU power.

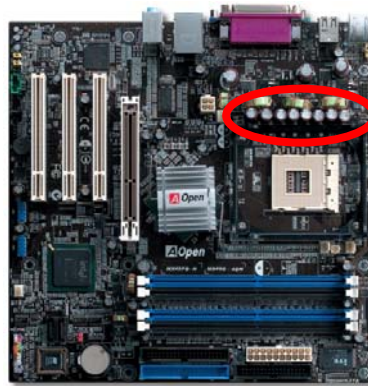



PBE – Performance Boosting Engine (for MX4SG-4DL / MX4SG-4DN)

Configuring Intel 865 chipset, the performance of this motherboard had been uplifted by implementing PBE Technology (Performance Boosting Engine). Acting as similar as PAT in uplifting the system performance, PBE enable users to optimize the accessing speed and quality between the CPU and Memory. Theoretically speaking, CPU must go through some standard paths to access memory. However, with an optimized path created, CPU may access memory through optimized path in a faster way. Therefore, PBE effectively shortened the distance between CPU and memory and thus increasing system performance as a matter of fact. To enable it, all you have to do is to go to BIOS screen, select **Advanced Chipset Feature/Performance Boost Engine**.

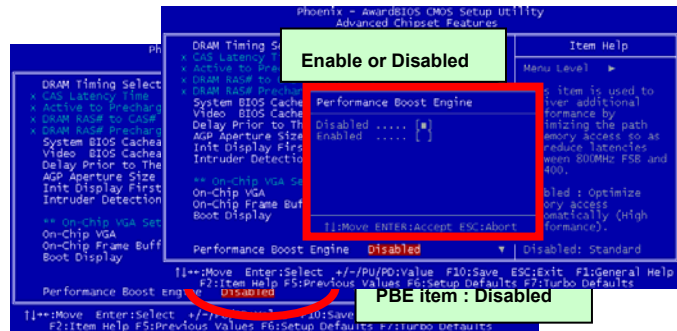
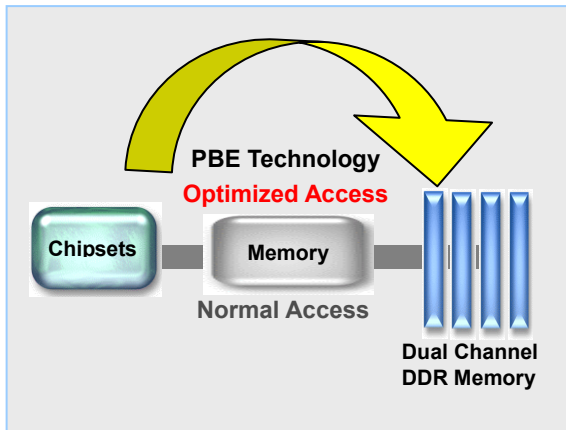

Note: Enabling this feature will make maximum use of your RAM modules. This is not standard specification of Intel 865G/865PE chipset. Uneven quality RAM modules in the market may not able to withstand this kind of extreme usage and cause the instability of your system. You are taking your own risk for taking advantage of this benefit.

The noise is gone!! ---- SilentTek



As the clock of CPU keeps rocketing higher and higher, it inevitably brings higher heat and system temperature in a relative way. The way we deal with this heat problem, however, is to spare no effort to add one fan after another to protect our pampered system, expecting these fans could cool down our machine as much as they could.

But at the same time, we believe that same users are affected terribly by the irritating noises of these fans while working with their PC. As a matter of fact, we do not have to get our fans running at such a high speed in most cases; on the contrary, we

Phoenix - AwardBIOS CMOS Setup Utility
Silent PC/PC Health Status

CPU Warning Temp.	60° C/140° F	
CPUFan1 Boot Speed	70% 3150 RPM	
SYSFan2 Boot Speed	70% 3500 RPM	
CPUFan1 OS Speed	100% 4500 RPM	
SYSFan2 OS Speed	100% 5000 RPM	
Fan Mode	Smart control	
x CPUFan1 Fixed Speed	100% 4500 RPM	
x SYSFan2 Fixed Speed	100% 5000 RPM	
CPU Set Temp.	40° C	
SYS Set Temp.	30° C	
CPU Kernel Temp.	69° C/156° F	
CPU Temp.	47° C/116° F	
SYS Temp.	31° C/107° F	
CPUFAN1 Speed	4500 RPM	
SYSFAN2 Speed	5000 RPM	
SYSFAN3 Speed	5532 RPM	
Vcore(V)	1.48 V	

Item Help

Menu Level ▶

This is fan control mode during POST and Open Jukebox, after exiting the Jukebox, the fan will be set to Fan OS Speed.

[Full Speed]
Run in full speed.

[Smart Control]
According to the safety temperature you set below, fan speed will be controlled as slow as possible.

↑↓←→:Move Enter:Select +/-/PU/PD:Value F10:Save ESC:Exit F1:General Help
F2:Item Help F5:Previous Values F6:Setup Defaults F7:Turbo Defaults

discovered that having your fans running at appropriate time and speed not only reduces the noise, but also consumes the least power the system needs, so as to prevent over-wasting of energy resource.

Today, AOpen Motherboard is honored to bring you a new overall solution, SilentTek, to make your system quiet. To collocate with hardware circuit, BIOS and the utility under Windows, SilentTek combined “Hardware-Status Monitoring”, “Overheat Warning” and “Fan Speed Control” with user-friendly interfaces to provide you a perfect balance among noises, system performance and stability.



The first image you have here is the Voltage Status page. You can find current status of all voltages and set your expected margins of warning level.

In "Temp/Fan/Case" page, you may get aware of the current temperature of CPU and the heat inside chassis. Also, you can check if fans are running properly.

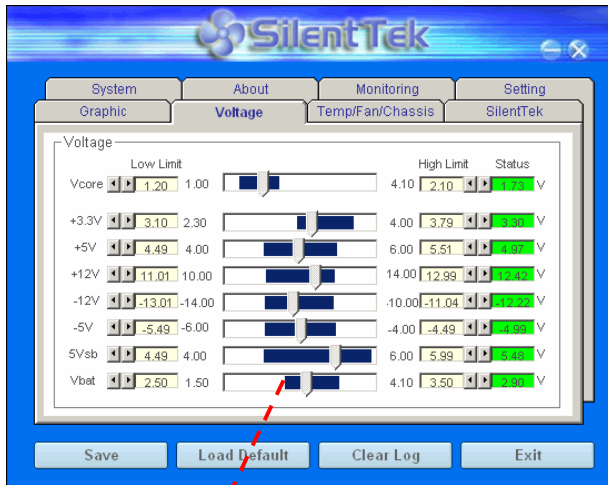

You may check your system voltage from the indicating bar here.

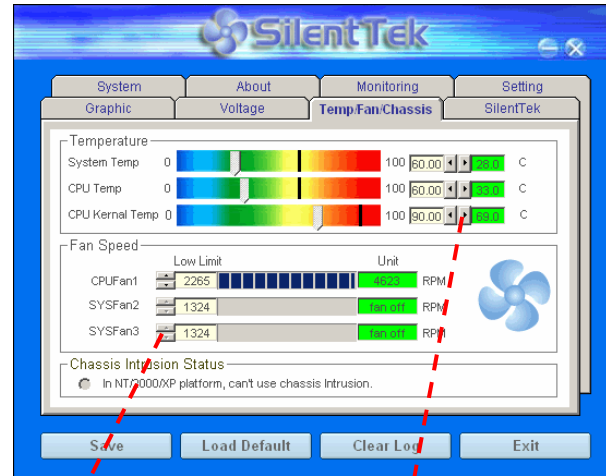

Of course, you may set your defaulted lowest margin for your fans and SilentTek would also pop up a message box to alarm you when the fan is rotating slower than this specified speed.

You may set the highest margin of your CPU and system temperature as default, and SilentTek would pop up a message box to alert you with alarm when the temperature goes beyond the specified margin.

The following page is surely the most important part of this utility. You may control the rotation speed of specific fans that you have got the options inside in this page.

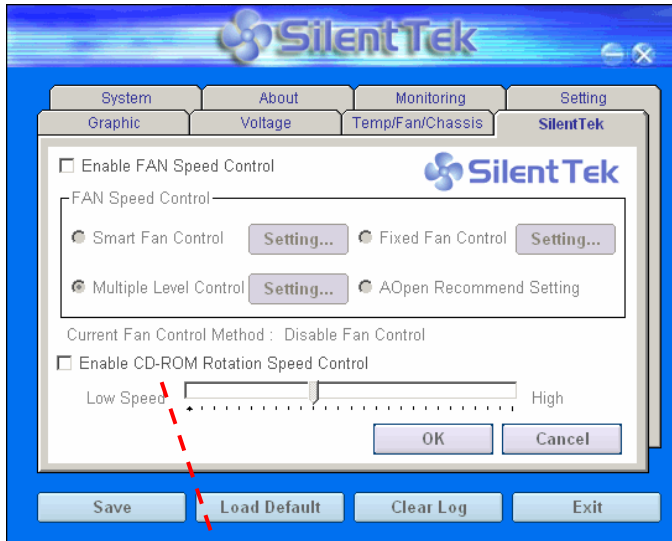

CD-ROM Rotation Speed Control: by enabling the CD-ROM Rotation Speed Control, you can adjust the rotation speed of your CD-ROM. When you set the speed to high level, the CD-ROM will work at its fastest speed and it will run at basic required speed while you set the value to low speed.

1. **Smart FAN Control:** This is the default setting of SilentTek and can be used for any branded computer housing. With a special algorithm developed by AOpen, the fan speed is automatically adjusted by the factors of CPU and ambient temperature. Ease-of-use and trouble free at your service.
2. **Fixed FAN Control:** Under this setting, a desired fan speed is set fixed when operating.
3. **Multiple Level Control:** This is the most versatile setting that allows you to set fan speed in relation to temperature. You may find that this setting fits you best.
4. **AOpen Recommend Setting:** This setting is designed specifically for AOpen housing. A series of lab tests were conducted under the real world scenario to determine optimum fan speed to reduce noise level within CPU working condition and temperature. Most of the time, the fan would remain still when CPU is not fully utilized.

Note: Due to hundreds different brands of fan on the market, inaccuracy may happen in some cases when you had your rotation speed adjusted. It is still under the criterion and please rest assured that it won't cause any problem to your system.

Hyper Threading Technology

What is Hyper-Threading?

Hyper-Threading technology is an innovative design from Intel that enables multi-threaded software applications to process threads in parallel within each processor resulting in increased utilization of processor execution resources. As a result, an average improvement of ~40% in CPU resource utilization yields higher processing throughput.

How Hyper-Threading Works

A form of simultaneous multi-threading technology (SMT), Hyper-Threading technology allows multiple threads of software applications to be run simultaneously on one processor by duplicating the architectural state on each processor while the same processor execution resources

is shared. The figure below represents how a Hyper-Threading based processor differentiates a traditional multiprocessor. The left-hand configuration shows a traditional multiprocessor system with two physical processors. Each processor has its own independent execution resources and architectural state. The right-hand configuration represents an Intel Hyper-Threading technology based processor. You can see that the architectural state for each processor is duplicated, while the execution resources is shared.

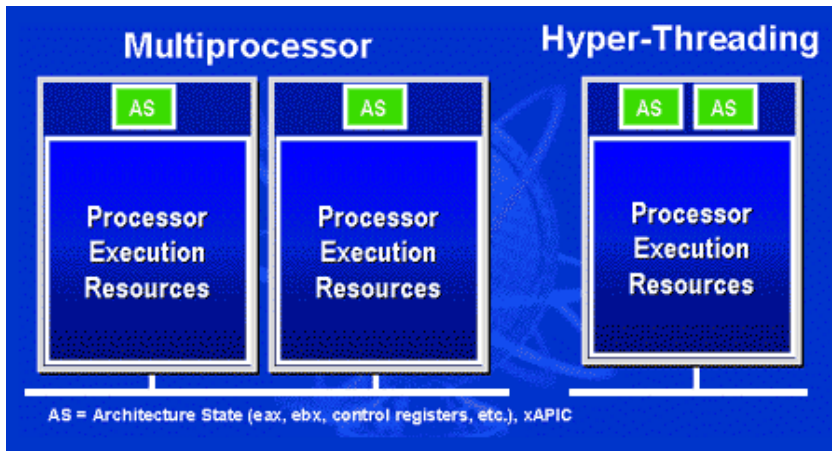

For multiprocessor-capable software applications, the Hyper-Threading based processor is considered two separate logical processors on which the software applications can run without modification. Also, each logical processor responds to interrupts independently. The first logical processor can track one software thread, while the second logical processor tracks another software thread simultaneously. Because the two threads share the same execution resources, the second thread can use resources that would be otherwise idle if only one thread was executing. This results in an increased utilization of the execution resources within each physical processor.

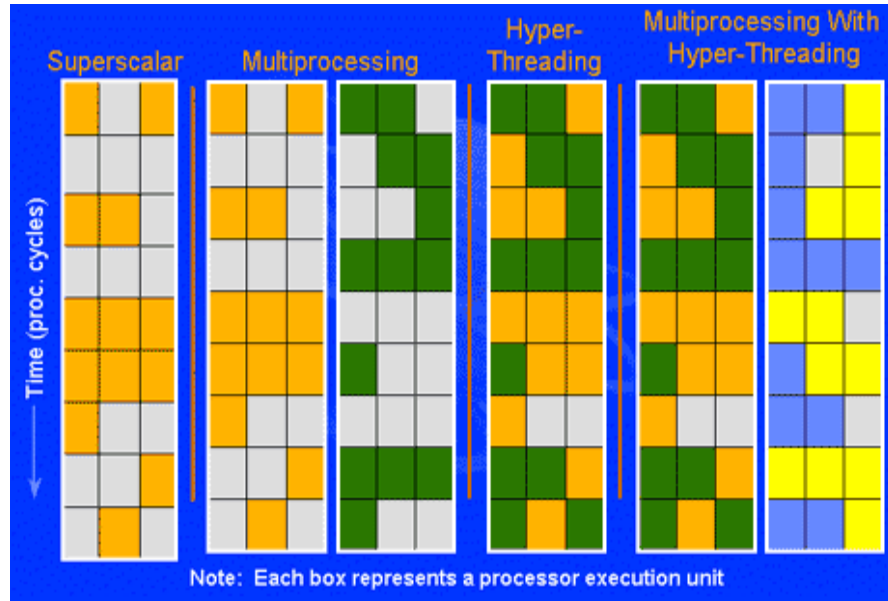

The figure below represents how Hyper-Threading saves time when it works. With two logical processors available on every single physical processor, multi-threaded applications can now take advantage of thread-level parallelism on each physical processor for additional performance. As software applications continue to be optimized to take greater advantage of processor parallelism, Hyper-Threading technology provides an additional boost for newer capabilities and the growing needs of today's users.

AOConfig Utility



AOConfig

AOpen always dedicated to provide users a much friendly computer environment. We now bring you a comprehensive system detection utility. AOConfig is a Windows based utility with user-friendly interface that allows users to obtain information of the operation system and hardware such as motherboard, CPU, memory, PCI devices and IDE devices. The powerful utility also displays the version of BIOS and firmware for your convenience of maintenance.

Moreover, AOConfig allows users to save information in *.BMP or *.TXT format which users may collect the system information in detail and send them to AOpen directly for technical support or for further diagnose of system problems.

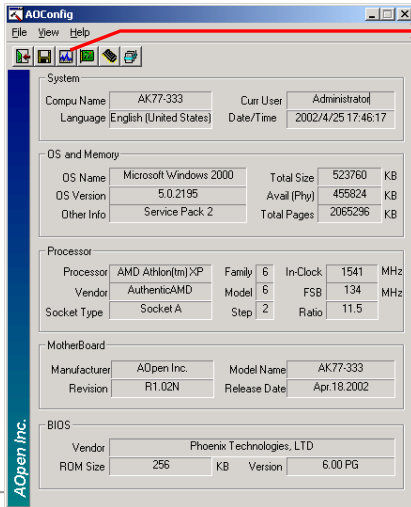

1. The system page shows the detailed information of the motherboard, operating system, processor, and BIOS version.

2. The PCI device page shows the configurations of all PCI devices installed in your motherboard.

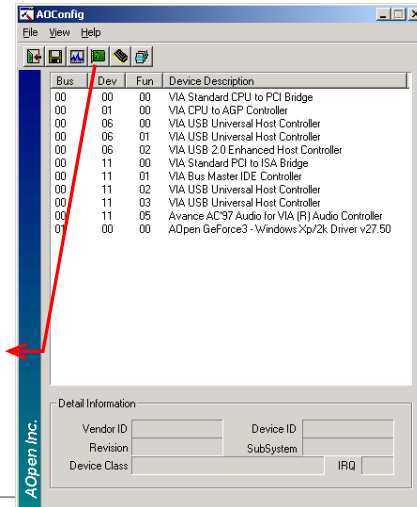

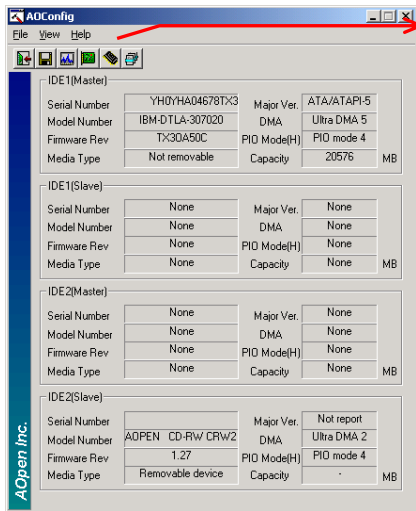

3. This page presents the IDE device information, such as serial number, manufacturer, firmware version, and capacity.

4. From this page, users can obtain the technical support information of AOpen. Moreover, detailed information could be saved in .bmp or .txt format.

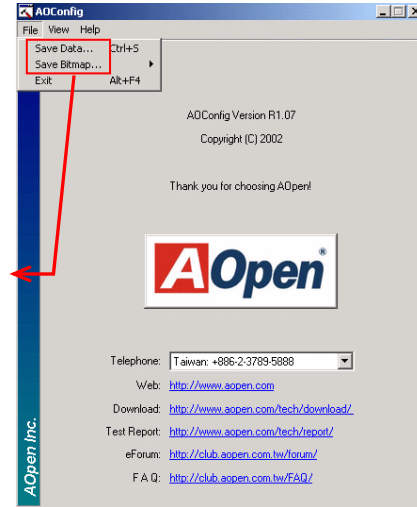

NOTE:

AOConfig can be used under Windows 98SE/ME, NT4.0/2000, or Windows XP. Please also note that AOConfig can only be operated in a system equipped with an AOpen motherboard. Before running AOConfig, all applications must be closed.



Phoenix-AWARD BIOS

System parameters can be modified by going into [BIOS](#) Setup menu, this menu allows you to configure the system parameters and save the configuration into the 128 bytes CMOS area, (normally in the RTC chip or in the main chipset).

Phoenix-Award BIOS™ installed in the [Flash ROM](#) of the motherboard is a custom version of an industry standard BIOS. The BIOS provides critical low-level support for standard devices such as hard disk drives, serial and parallel ports.

Most BIOS settings of MX4SG-4DL / MX4SG-4DN / MX4SPB-N have been optimized by AOpen's R&D engineering team. But, the default setting of BIOS still can't fine-tune the chipset controlling entire system. Therefore, the rest of this chapter intends to guide you the process of configuring your system setup.

To enter to BIOS setup menu, press when [POST \(Power-On Self Test\)](#) screen is shown on your monitor.

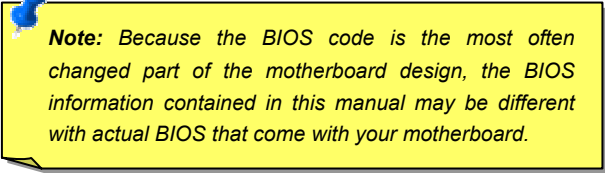

***Note:** Because the BIOS code is the most often changed part of the motherboard design, the BIOS information contained in this manual may be different with actual BIOS that come with your motherboard.*

How To Use Phoenix-Award™ BIOS Setup Program

Generally, you can use arrow keys to highlight items that you want to choose, then press <Enter> key to select, and use the <Page Up> and <Page Down> key to change setting values. You can press <Esc> key to quit Phoenix-Award™ BIOS setup program. The following table provides details about how to use keyboard in the Phoenix-Award™ BIOS setup program.

Key	Description
Page Up or +	Changing setting to next value or increase the value.
Page Down or -	Changing setting to previous value or decrease value.
Enter	Select the item.
Esc	1. In main menu: Quit and don't save any change. 2. In sub menu: Exit current menu to main menu.
Up Arrow	Highlight previous item.
Down Arrow	Highlight next item.
Left Arrow	Move the light bar to left side of menu.
Right Arrow	Move the light bar to right side of menu.
F6	Load fail-save setting value from CMOS.
F7	Load turbo setting value from CMOS.
F10	Save changed setting and exit setup program.

How To Enter BIOS Setup

After you finish jumper settings and connect correct cables, power on and enter the BIOS Setup. Press during [POST](#) (Power-On Self Test) and choose "Load Setup Defaults" for recommended optimal performance.

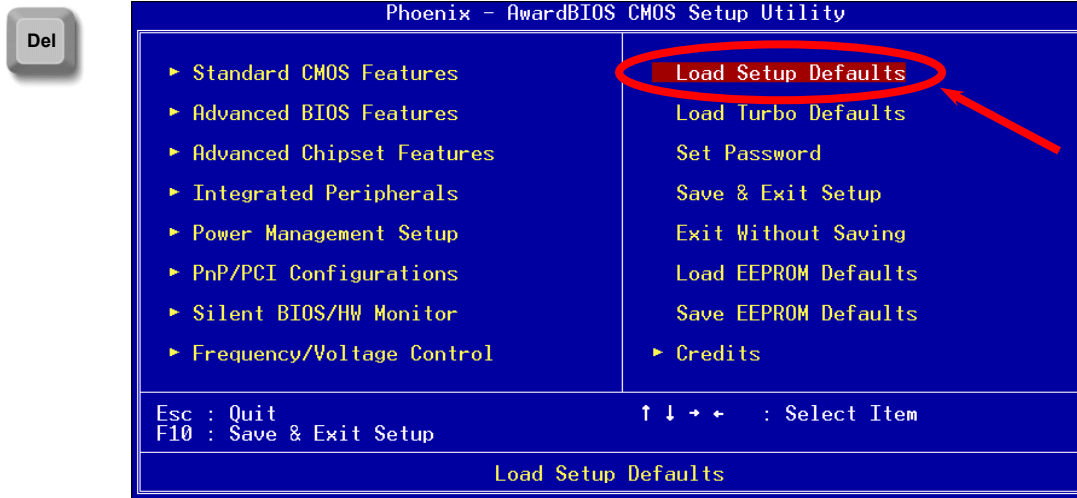

Warning: Please avoid of using "Load Turbo Defaults", unless you are sure your system components (CPU, DRAM, HDD, etc.) are good enough for turbo setting.

BIOS Upgrade under Windows environment



With outstanding R&D ability of AOpen, we now bring you a whole new BIOS Flash wizard ---- EzWinFlash. With an eye to users convenience, EzWinFlash combines the BIOS binary code and flash module together, so the only thing you have to do is just clicking on the utility you downloaded from web and let it helps you complete the flash process automatically. EzWinFlash detects your motherboard and checks the BIOS version cleverly to prevent your system from any possible failure. Moreover, EzWinFlash has been taken into consideration to go with any windows platform you might be using, no matter if you're using Windows 95/98, 98SE/ME, NT4.0/2000, or Windows XP.

In the meanwhile, in order to provide a much more user-friendly operating environment, AOpen EzWinFlash is natively designed to have multi-language function to provide easier way for users' usage in changing BIOS setting.



Caution: By updating your motherboard, you are taking a risk of BIOS flash failure. If your motherboard is working stable, and there are no major bugs that had been fixed by a latter BIOS revision, we recommend that you **DO NOT** try to upgrade your BIOS.

If you intent on upgrading, **PLEASE BE SURE** to get the right BIOS revision for the right motherboard model to avoid any possibility failure.

You may accomplish BIOS upgrade procedure with EzWinFlash by the following steps, and it's STRONGLY RECOMMENDED to close all the applications before you start the upgrading.

1. Download the new version of BIOS package [zip](http://www.aopen.com) file from AOpen official web site. (Ex: <http://www.aopen.com>)
2. Unzip the download BIOS package (ex: WSG4DL102.ZIP) with WinZip (<http://www.winzip.com>) in Windows environment.
3. Save the unzipped files into a folder, for example, WSG4DL102.EXE & WSG4DL102.BIN.
4. Double click on the WSG4DL102.EXE; EzWinFlash will detect the model name and BIOS version of your motherboard. If you had got the wrong BIOS, you will not be allowed to proceed with the flash steps.
5. You may select preferred language in the main menu, then click [Start Flash] to start the BIOS upgrade procedure.
6. EzWinFlash will complete all the process automatically, and a dialogue box will pop up to ask you to restart Windows. You may click [YES] to reboot Windows.
7. Press at POST to enter BIOS setup; choose "Load Setup Defaults", then "Save & Exit Setup". Done!

It is strongly recommended NOT to turn off the power or run any application during FLASH PROCESS.

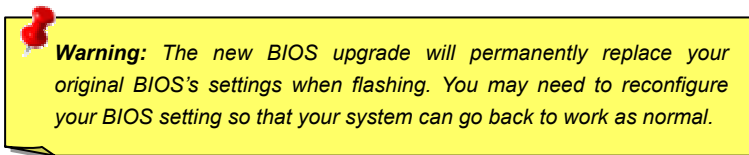

Vivid BIOS technology

NEW!

Have you been fed up with the conservative and immutable POST screen? Let's rule out the tradition idea that POST screen are stiff and frigid, and let AOpen show you the newly developed VividBIOS to experience the lively vivid colourful POST screen!

Unlike earlier graphic POST screen which could occupy the whole screen and mask text information during POST, AOpen VividBIOS deals with graphics and texts separately, and makes them running simultaneously during POST. With this innovative design, VividBIOS now brings you a beautiful and sleek 256 colours screen without missing any important information shown on POST screen.

In addition, the limited space of BIOS ROM is another big issue. When all of the traditional BIOS can only show space-consuming and uncompressed Bitmap, AOpen has considerably tuned the BIOS to next generation, to recognize the smaller-sized GIF format and even dynamic-showing GIF animation.



You may use the EzSkin utility to change your Vivid BIOS screen or to download your favourite skin. If you see this little logo



shown beside your model name on the BIOS download page, <http://english.aopen.com.tw/tech/download/skin>, it is assured that your motherboard supports this innovative feature!

Driver and Utility –



You may think that installing drivers and utilities would be a repeated task of going through those installation wizards and steps-by-steps. Now, you will be surprised with how “EZ” EzInstall could do. Without wizards or steps, all you have to do is to do one click and then it’s done. Click and done. Yes. EzInstall makes installation easy and even foolproof!

After putting in the CD, you will be prompted with AOpen welcome page and our branches information.

1. First, click on the **install driver** ICON at left side for necessary drivers.
2. Second, click on the **install utility** ICON at left side for preferred utilities.

Practically, it’s done. But you may also **browse CD contents**, **Readme** to get more information or just **exit the CD** installation.

The screenshot shows the AOpen MX4SG-4DL Welcome screen. On the left side, there are five circular icons with callout boxes: 'Install driver' (CD icon), 'Install utility' (floppy disk icon), 'Browse CD contents' (CD with magnifying glass icon), 'Readme' (document icon), and 'Exit CD' (CD in drive icon). On the right side, there are two callout boxes: 'Click to install online manual' (pointing to a manual icon) and 'AOpen Branches Information' (pointing to the contact information section).

Welcome
Install User manual of your motherboard

Thank you for choosing AOpen MX4SG-4DL

Contact us

AOpen Inc. http://www.aopen.com.tw TEL: +886-2-3789-5888 FAX: +886-2-3789-5899	AOpen Computer GmbH. http://www.aopencom.de TEL: +49-2131-1243-710 FAX: +49-2131-1243-999
AOpen America Inc. http://english.aopen.com.tw TEL: +1-510-489-8928 FAX: +1-510-489-1998	AOpen Japan Inc. http://www.aopen.co.jp TEL: +81-048-290-1800 FAX: +81-048-290-1820
AOpen Computer B.V. http://www.aopen.nl TEL: +31-73-645-9516 FAX: +31-73-645-9604	AOpen International Co., Ltd. http://www.aopen.com.cn TEL: +86-21-6225-8622 FAX: +86-21-6225-7926

Ez Install

Installing Drivers

As you may see from the Installing driver page, EzInstall had picked up necessary for your motherboard. All you have to do is just click on the “GO”, and no more steps afterward, Of all listed drivers, grey checks indicate necessary drivers; you cannot click them off. Red checks can be disabled if you don't want to install them now.

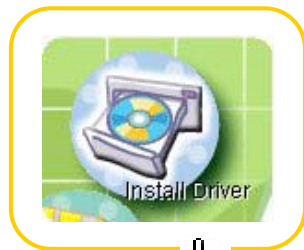

Press the icon will prompt the “Install Driver” page for your selection. You may also press “Back” to get back to the Main page.

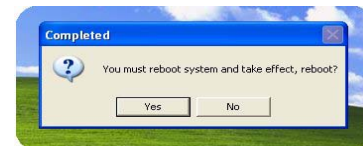
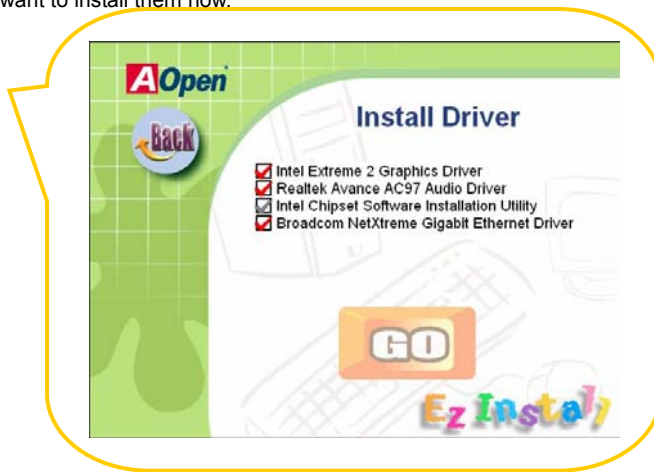

Installing Utilities

Installing Utilities is virtually the same as installing drivers. AOpen provides you many friendly and powerful utilities to manage your system. You may find lots of fabulous utilities listed there, and all you have to do is to click on the “GO”, then it will install the utilities to your system right away without complicated steps.



Press the icon will prompt the “Install Driver” page for your selection. You may also press “Back” to get back to the Main name

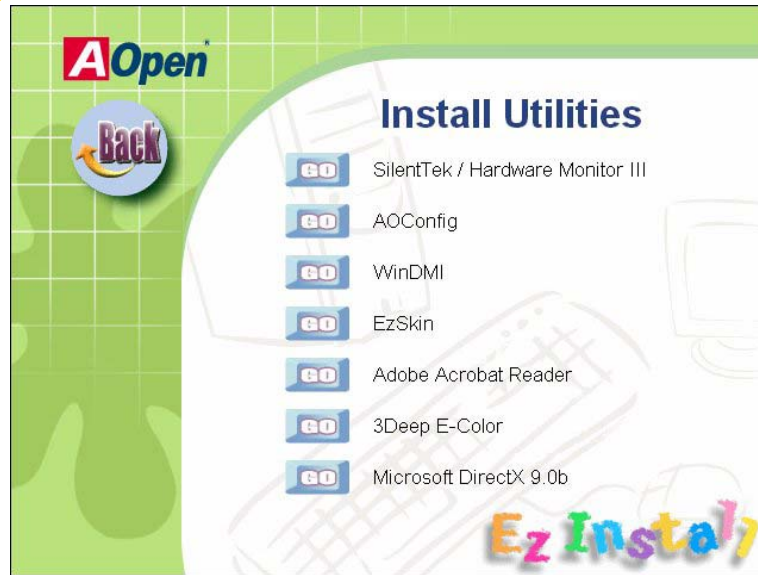

Glossary

AC'97 CODEC

Basically, AC'97 CODEC is the standard structure of PCI sound card. As we know, computer is digital-based, but music is based on analog-based. Therefore, there must be a process to turn digital into analog during the last stage processing of sound in computer. Hence, the component on sound card that play this important task is what we called CODEC.

Audio CODEC 97 (briefly called AC'97) is the specification regulated by Intel, and it's about the structure of audio conversion. The special place about CODEC is that it is separated from sound card (CODEC is an independent chipset). Therefore, PCI sound card could possess with 90db and do other application process as well. We called CODEC that meets this structure AC'97 CODEC.

ACPI (Advanced Configuration & Power Interface)

ACPI is the power management specification of PC97 (1997). It intends to save more power by taking full control of power management to operating system and bypass [BIOS](#). The chipset or super I/O chip needs to provide standard register interface to operating system (such as Windows 98). This is a bit similar as the [PnP](#) register interface. ACPI defines ATX momentary soft power switch to control the power state transition.

ACR (Advanced Communication Riser)

Building on the PC motherboard riser architecture, ACR slot is backward compatible with AMR but beyond the limitation of it. The ACR specification is designed to support modem, audio, Local Area Network (LAN) and Digital Subscriber Line (DSL).

AGP (Accelerated Graphic Port)

The main function of AGP simply put is to tell monitor what screen information had to be shown, a visual transmission device actually. With the rapid developing of AGP card, we can see that it had been developed from single colorful AGP card to 2D and 3D graphic. AGP supports only memory read/write operation and single-master single-slave one-to-one only. Though AGP and PCI share the same algorithm of 32-bit, its frequencies are 66MHz and 33MHz respectively. AGP interface had been developed from 2X to 8x.

1X AGP, data transfer rate is $66\text{MHz} \times 4\text{byte} \times 1 = 264\text{MB/s}$

2X AGP, data transfer rate is $66\text{MHz} \times 4\text{byte} \times 2 = 528\text{MB/s}$

4X AGP, data transfer rate is $66\text{MHz} \times 4\text{byte} \times 4 = 1056\text{MB/s}$.

8X AGP, data transfer rate is $66\text{MHz} \times 4\text{byte} \times 8 = 2112\text{MB/s}$.

AMR (Audio/Modem Riser)

The CODEC circuit of AC'97 sound/modem solution can be put on motherboard or put on a riser card (AMR card) that connects to motherboard through AMR connector.

ATA (AT Attachment)

Before talking about ATA (AT Attachment), we must understand **DMA** (Direct Memory Access), which allows devices to skip the CPU devices and access memory directly. DMA specification could not only eliminate the workload of CPU, but also accelerate the transmission of data. DMA begins with a data transfer rate of 16.6MB/Sec, but afterward developed to new data rate of 33.3MB/Sec, which is twice the data rate and we called it **Ultra DMA**. **ATA** details power and data signals between the drive and integrated drive controller and the computer's motherboard. Two drives (master and slave) are supported. The ATA specification allows the drive to connect directly to the ISA bus on the computer. ATA transfer rate then had been developed to 133MHz/Sec and would come out with fastest rate later (please refer to [Serial ATA](#)).

DMA, data transfer rate is 16.6MHz/s

Ultra DMA, data transfer rate is 16.6MHz x 2 = 33MB/s.

ATA/66, data transfer rate is 16.6MHz x 4 = 66MB/s.

ATA/100, data transfer rate is 16.6MHz x 6 = 100MB/s.

ATA/133, data transfer rate is 16.6MHz x 8 = 133MB/s.

(ATA/133 uses both rising edge and falling edge as ATA/66 but clock cycle time is reduced to 30ns.)

BIOS (Basic Input/Output System)

BIOS, is a set of assembly routine/program that reside in [EPROM](#) or [Flash ROM](#). BIOS controls Input/output devices and other hardware devices of motherboard. In general, to provide hardware independent portability, operation system and drivers is required to access BIOS without directly access hardware devices.

Bluetooth

Bluetooth is a wireless transferring technology that enables short-range wireless connections between desktop and laptop computers, personal digital assistants (PDAs), cellular phones, printers, scanners, digital cameras and even home appliances. The principle of Bluetooth (a chipset) is to transfer information and voices at the frequency of ISM Band. Every Bluetooth technology devices do come with a standard address for you to connect one-to-one or one-to-seven (to form a Pico-net), with transferring range up to 10 meters (100 meters to follow), using low power radio. Bluetooth do not only possess high transfer rate of 1MB/s, it also could be encrypted with pin code. With hopping rate of 1600 hops per second, it's difficult to be intercepted and are less interrupted by electromagnetic wave.

CNR (Communication and Networking Riser)

The CNR specification provides the PC industry the opportunity to deliver a flexible and cost reduced method of implementing LAN, home networking, DSL, USB, wireless, audio and modem subsystems widely used in today's "connected PCs". The CNR specification is an open industry specification and is supported by OEMs, IHV card manufacturers, silicon supplier and Microsoft.

DDR (Double Data Rate) SDRAM

DDR SDRAM utilizes the existing [SDRAM](#) (For ex, PC-100, PC-133) infrastructure and technology while doubling the nominal bandwidth available to systems in an easy to design and simple to adopt way. Based on FSB frequency, DDR SDRAM on the market are DDR200, DDR266 and DDR333 with more coming around soon.

DDR200, transfer bandwidth up to $200 \times 64 / 8 = 1600 \text{MB/s}$ (PC1600)

DDR266, transfer bandwidth up to $266 \times 64 / 8 = 2100 \text{MB/s}$ (PC2100)

DDR333, transfer bandwidth up to $333 \times 64 / 8 = 2700 \text{MB/s}$ (PC2700)

DDR400, transfer bandwidth up to $400 \times 64 / 8 = 3200 \text{MB/s}$ (PC3200)

ECC (Error Checking and Correction)

The ECC mode needs 8 ECC bits for 64-bit data. Each time memory is accessed; ECC bits are updated and checked by a special algorithm. The ECC algorithm has the ability to detect double-bit error and automatically correct single-bit error while parity mode can only detect single-bit error.

EEPROM (Electronic Erasable Programmable ROM)

Also be known as E²PROM. Both EEPROM and [Flash ROM](#) can be re-programmed by electronic signals, but the interface technology is different. Size of EEPROM is much smaller than flash ROM.



EPROM (Erasable Programmable ROM)

Traditional motherboard stores BIOS code in EPROM. EPROM can only be erased by ultra-violet (UV) light. If BIOS has to be upgraded, you need to remove EPROM from motherboard, clear by UV light, re-program, and then insert back.

EV6 Bus

EV6 Bus is the technology of Alpha processor from Digital Equipment Corporation. EV6 bus uses both rising and falling clock edge to transfer data, similar as DDR SDRAM or ATA/66 IDE bus.

EV6 Bus Speed = CPU external bus clock x 2.

200 MHz EV6 bus, 200MHz = 100 MHz external bus clock x 2

FCC DoC (Declaration of Conformity)

The DoC is component certification standard of FCC EMI regulations. This standard allows DIY component (such as motherboard) to apply DoC label separately without a shielding of housing.

FC-PGA (Flip Chip-Pin Grid Array)

FC means Flip Chip, FC-PGA is a package of Intel for Pentium III for 0.18µm process CPU, which can be plugged into SKT370 socket.

FC-PGA2 (Flip Chip-Pin Grid Array)

After FC-PGA, FC-PGA2 is the package for 0.13µm process CPU developed by Intel, which can be plugged into SKT423/478 socket as well.

Flash ROM

Flash ROM can be re-programmed by electronic signals. It is easier for BIOS to upgrade by a flash utility, but it is also easier to be infected by virus. Because of increase of new functions, BIOS size is increased from 64KB to 512KB (4M bits).

Hyper Threading

Hyper-Threading technology is an innovative design from Intel that enables multi-threaded software applications to process threads in parallel within each processor resulting in increased utilization of processor execution resources. As a result, an average improvement of ~40% in CPU resource utilization yields higher processing throughput.

IEEE 1394

IEEE 1394, which also called Firewire, is a serial data transfer protocol and interconnection system. The main feature of the Firewire that assures its adoption for the digital video and audio (A/V) consumer application is its low cost. Fire wire interface is capable of supporting various high-end digital A/V applications, such as consumer A/V device control and signal routing, Digital Video (DV) editing, home networking, and more than 32 channels of digital mixing. Gone are those days of expensive video capture cards. Firewire allows for video capture from both newer DV camcorders with Firewire ports and older analog equipment using A/V to Firewire converters.

The advantages of the IEEE1394:

High data transfer rate – Start from 400 Mbps, (with 800/1600/3200 Mbps coming soon), which is about 30 times faster than USB 1.1.

Supports up to 63 devices (16 - daisy chained) with cable length up to about 4.5 m (14 feet).

Hot-pluggable (like USB). No need to turn of your device to connect or disconnect, and you don't need to reboot your PC. Also, it is a plug-and-play bus.

IEEE1394 is very easy to connect (Like USB1.1/2/0).

Parity Bit

The parity mode uses 1 parity bit for each byte, normally it is even parity mode, that is, each time the memory data is updated, parity bit will be adjusted to have even count "1" for each byte. When next time, if memory is read with odd number of "1", the parity error is occurred and this is called single bit error detection.

PCI (Peripheral Component Interface) Bus

Developed by Intel, Peripheral Component Interconnect (PCI) is a local bus standard. A bus is a channel used to transfer data to (input) and from (output) a computer and to or from a peripheral device. Most PCs have a PCI bus usually implemented at 32-bits providing a 33 MHz clock speed with a throughput rate of 133 MB/sec.

PDF Format

With PDF file, it is easy to do universal document exchange. Virtually any document may be converted in Portable Document Format (PDF). Contents in PDF documents are exactly the same as the original file, including fonts and graphics, and they can be distributed by e-mail or stored on the World Wide Web, an intranet, a file system, or a CD-ROM for other users to view on any platforms. You may download Acrobat Reader in order to read PDF file from its website (www.adobe.com).

PnP (Plug and Play)

Oversimplified, Plug-and-Play automatically tells the software (device drivers) where to find various pieces of hardware (devices) such as modems, network cards, sound cards, etc. Plug-and-Play's task is to match up physical devices with the software (device drivers) that operates them and to establish channels of communication between each physical device and its driver.

POST (Power-On Self Test)

The BIOS self-test procedure after power-on, sometimes, it is the first or the second screen shown on your monitor during system boot.

PSB (Processor System Bus) Clock

PSB Clock means the external bus clock of CPU.

CPU internal clock = CPU PSB Clock x CPU Clock Ratio

RDRAM (Rambus Dynamic Random Access Memory)

A DRAM technology developed by Rambus Corporation*, to achieve high speed of memory through the use of multiple channels in parallel by 16-bits. Basically, RDRAM uses new structure of Multibank, which is quite different from FPM, EDO, SDRAM. Using different memory module as well, RDRAM uses "RIMM" with transfer rate of 600/700/800MHz, providing bandwidth as high to 1.6GB.

RIMM (Rambus Inline Memory Module)

184-pin memory module that supports [RDRAM](#) memory technology. A RIMM memory module may contain up to maximum of 16 RDRAM devices.

SDRAM (Synchronous DRAM)

SDRAM is one of the DRAM technologies that allow DRAM to use the same clock as the CPU host bus (EDO and FPM are asynchronous and do not have clock signal). It is similar as PBSRAM to use burst mode transfer. SDRAM comes in 64-bit 168-pin DIMM and operates at 3.3V, and have been gradually replaced by DDR SDRAM.

SATA (Serial ATA)

The Serial ATA specification is designed to overcome speed limitations while enabling the storage interface to scale with the growing media rate demands of PC platforms. Serial ATA is to replace parallel [ATA](#) with the compatibility with existing operating systems and drivers, adding performance headroom for years to come. It is developed with data transfer rate of 150 Mbytes/second, and 300MB/s, 600MB/s to come. It reduces voltage and pins count requirements and can be implemented with thin and easy to route cables.

SMBus (System Management Bus)

SMBus is also called I²C bus. It is a two-wire bus developed for component communication (especially for semiconductor IC). For example, set clock of clock generator for jumper-less motherboard. The data transfer rate of SMBus is only 100Kbit/s; it allows one host to communicate with CPU and many masters and slaves to send/receive message.

SPD (Serial Presence Detect)

SPD is a small ROM or [EEPROM](#) device resided on the DIMM or [RIMM](#). SPD stores memory module information such as DRAM timing and chip parameters. SPD can be used by [BIOS](#) to decide best timing for this DIMM or RIMM.

USB 2.0 (Universal Serial Bus)

A Universal Serial Bus (USB) is an external bus (an interconnect) standard that supports data transfer rates of 12 Mbps. A single USB port can be used to connect up to 127 peripheral devices, such as mouse, modems and keyboards. Introduced in 1996, USB has completely replaced serial and parallel ports. It also supports plug-and-play installations and hot plugging. Plug-and-play is the ability to add and remove devices to a computer while the computer is running and have the operating system automatically recognize the change. USB 2.0, which supports data transfer rates of 480 Mbps, has been widely used in motherboard these days.

VCM (Virtual Channel Memory)

NEC's Virtual Channel Memory (VCM) is a new DRAM core architecture that dramatically improves the memory system's ability to service multimedia requirements. VCM increases memory bus efficiency and performance of any DRAM technology by providing a set of fast static registers between the memory core and I/O pins. Using VCM technology results in reduced data access latency and reduced power consumption.

Wireless LAN – 802.11b

802.11 is a specification developed by IEEE and Wireless LAN technology, which is an interface between a wireless client and a base station or between two wireless clients.

802.11 families include the following specifications and with more coming:

802.11 = 1 or 2 Mbps transmission in the 2.4 GHz band, using either frequency hopping spread spectrum (FHSS) or direct sequence spread spectrum (DSSS).

802.11a = 54 Mbps in the 5GHz band, using orthogonal frequency division multiplexing)

802.11b (11 Mbps transmission in the 2.4 GHz band, using direct sequence spread spectrum (DSSS).

ZIP file

A compressed file format to reduce file size. To unzip file, run shareware PKUNZIP (<http://www.pkware.com/>) for DOS and other operating system or WINZIP (<http://www.winzip.com/>) for windows environment.



Troubleshooting

If you encounter any trouble to boot your system, follow the procedures accordingly to resolve the problem.

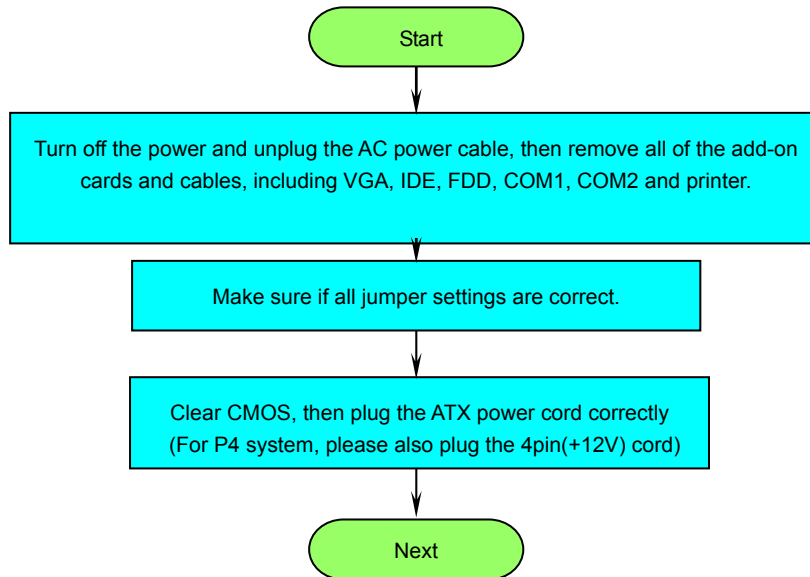

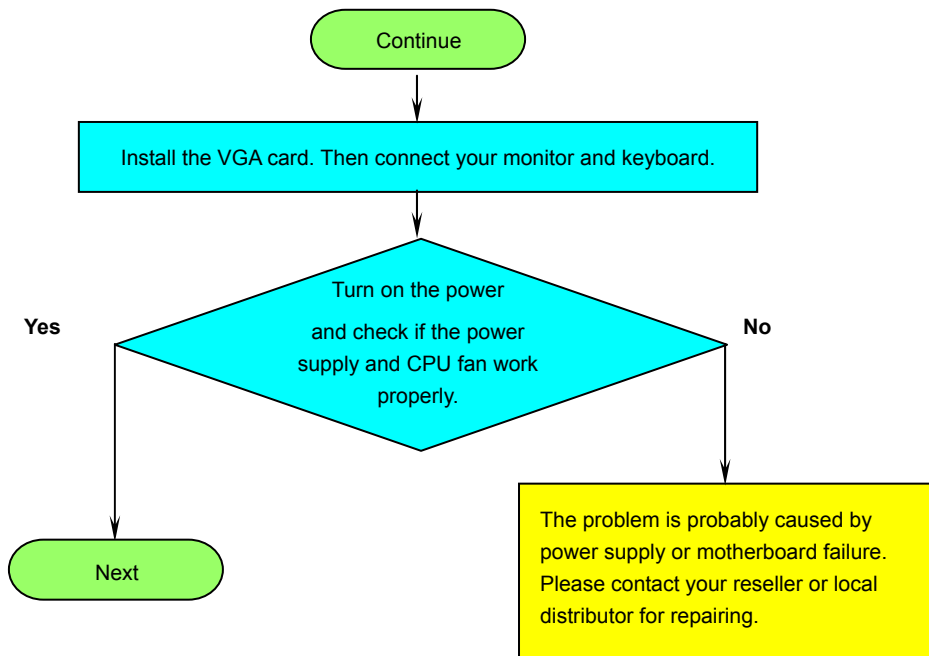

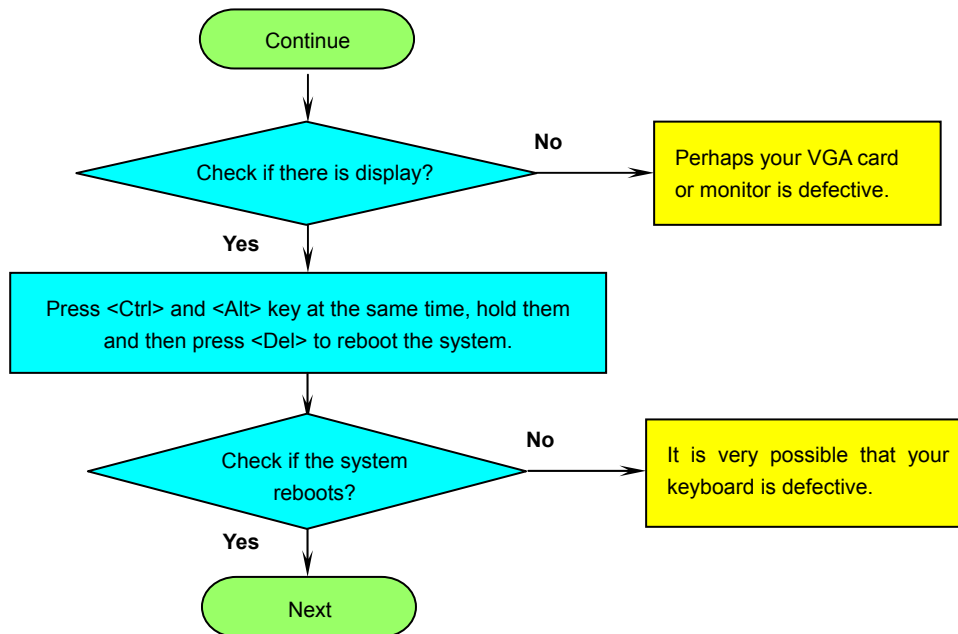

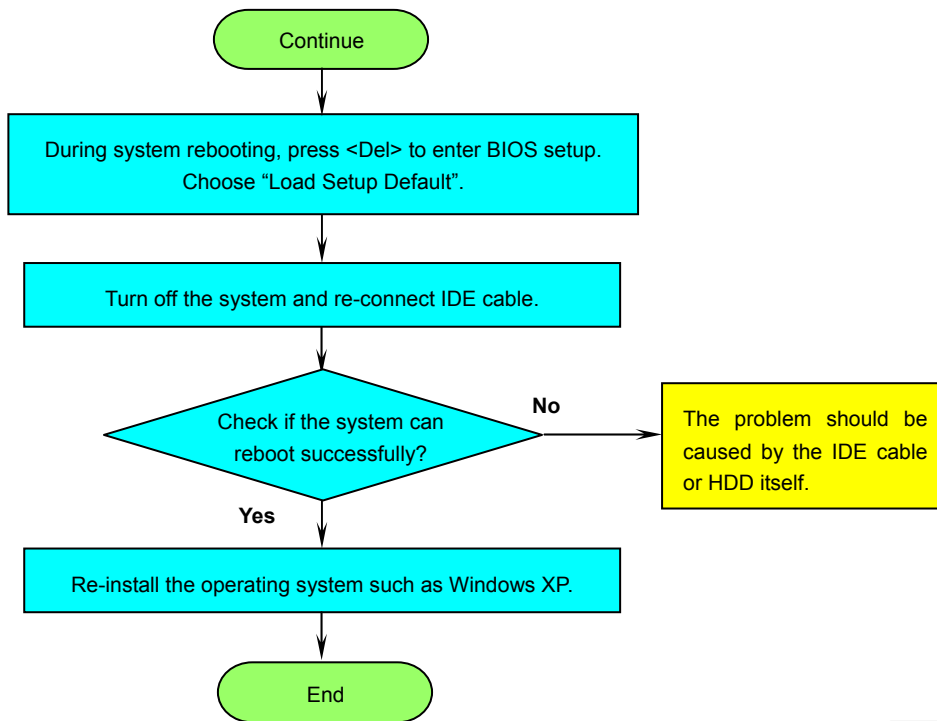



Technical Support

Dear Customer,

Thanks for choosing AOpen products. To provide the best and fastest service to our customer is our first priority. However, we receive numerous emails and phone-calls worldwide everyday, it is very hard for us to serve everyone on time. We recommend you follow the procedures below and seek help before contact us. With your help, we can then continue to provide the best quality service to more customers.

Thanks very much for your understanding!

AOpen Technical Supporting Team

1

Online Manual: To download manual, please log on and then select your preferred language. Under “Type” directory, choose “Manuals” to go to our manual database. You can also find the manual and EIG in AOpen Bonus Pack.

<http://download.aopen.com.tw/downloads>

2

Test Report: We recommend you to choose board/card/device from the compatibility test reports for assembling your PC. It may prevent incompatibility problems.

<http://english.aopen.com.tw/tech/report/default.htm>

3

FAQ: Here we list problems that users often encounter and FAQ (Frequently Asked Questions). You may be able to find a solution to your problem.

<http://club.aopen.com.tw/faq/>

4

Download Software: After log on and having language selected, you may get the latest updated BIOS/utility and drivers you need under “Type” directory. In most case, newer versions of drivers and BIOS have solved earlier bugs or compatibility problems.

<http://download.aopen.com.tw/downloads>



5

eForum: AOpen eForum is provided to discuss our products with other users, in which your problem probably had been discussed before or will be answered. After log on, you may select your preferred language under "Multi-language".

<http://club.aopen.com.tw/forum/>

6

Contact Distributors/Resellers: We sell our products through resellers and integrators. They should know your system configuration very well and should be able to solve your problem efficiently and provide important reference for you.

7

Contact Us: Please prepare detail system configuration and error symptom before contacting us. The **part number**, **serial number** and **BIOS version** are also very helpful.

Part Number and Serial Number

The Part Number and Serial number are printed on bar code label. You can find this bar code label on the outside packing, or on component side of PCB. For example:

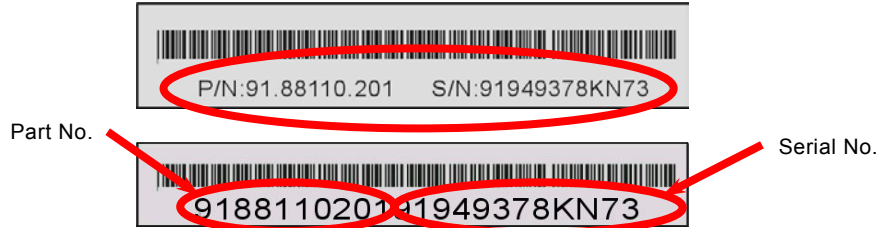

P/N: 91.88110.201 is part number, **S/N: 91949378KN73** is serial number.

Model name and BIOS version

Model name and BIOS version can be found on upper left corner of first boot screen ([POST](#) screen). For example:



MX4SG-4DL R1.00 Aug. 1. 2003 AOpen Inc.

Phoenix-Award Plug and Play BIOS Extension v1.0A

Copyright © 2003, Award Software, Inc.

MX4SG-4DL is model name of motherboard; **R1.00** is BIOS version.



Product Registration

ClubAOpen

Welcome to AOpen Inc.



Thank you for choosing AOpen product. AOpen encourages you to spend few minutes in completing the following product registration. To register your product will ensure the high quality of services from AOpen. After the registration, you will:

- Have opportunities to play online slot machine and win a prize from AOpen by accumulating your bonuses for later prize exchange.
- Be upgraded to gold membership of Club AOpen program.
- Receive email notification about product safety alerts. Its purpose is to alert consumers quickly and conveniently when products contain technical issues.
- Receive email notification about latest product's announcements.
- Be able to personalize your AOpen web pages.
- Receive e-mail notification about latest BIOS/Driver/Software release information.
- Have opportunities to participate special product promotional programs.
- Enjoy higher service priority to receive technical assistance provided by AOpen specialists worldwide.
- Be able to join the discussions of web-based news groups.

AOpen makes sure that the information you provide is encrypted, so that it cannot be read or intercepted by other people or companies. Further, AOpen will not disclose any of information you submitted under any conditions. Please consult our [online privacy policy](#) for further information on our company policy.

Note: *If registering products purchased from different dealers/retails and/or purchased on different dates, please submit a separate form for each product.*



How to Contact Us



Please do not hesitate contact us if you have any problem about our products. Any opinion will be appreciated.

Pacific Rim

AOpen Inc.

Tel: 886-2-3789-5888

Fax: 886-2-3789-5899

Europe

AOpen Computer b.v.

Tel: 31-73-645-9516

Email: Support@AOpen.NL

America

AOpen America Inc.

Tel: 1-510-498-8928

Fax: 1-408-922-2935

China

艾爾鵬國際貿易(上海)有限公司

Tel: 86-21-6225-8622

Fax: 86-21-6225-7926

Germany

AOpen Computer GmbH.

Tel: 49-2131-1243-710

Fax: 49-2131-1243-999

Japan

AOpen Japan Inc.

Tel: 81-048-290-1800

Fax: 81-048-290-1820

Web Site: <http://www.aopen.com.tw>

E-mail: Send us email by going through the contact form below.

English <http://english.aopen.com.tw/tech/default.htm>

Japanese <http://www.aopen.co.jp/tech/default.htm>

Chinese <http://www.aopen.com.tw/tech/default.htm>

German <http://www.aopencom.de/tech/default.htm>

Simplified Chinese <http://www.aopen.com.cn/tech/default.htm>

