

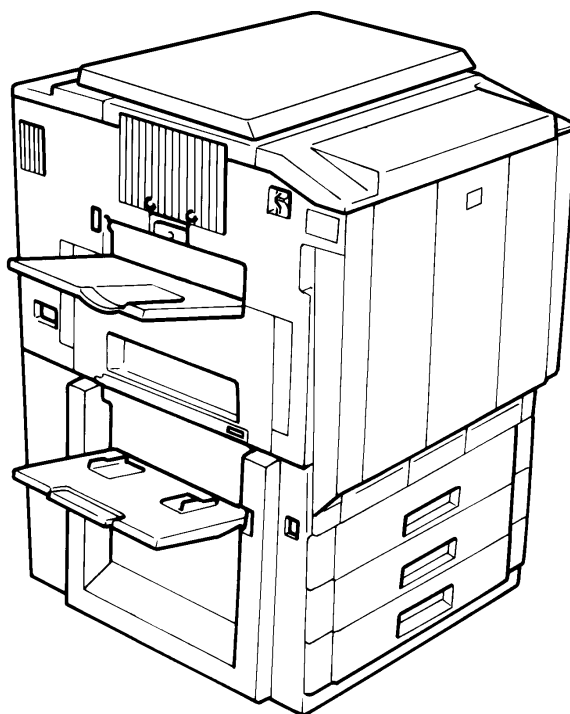

CF911PE

Operator's Manual



Using the Printer Properly

To ensure optimum performance of the printer, follow the precautions listed below.

- Never place a heavy object on the printer.
- Never subject the printer to shocks.
- Never open any doors or turn the printer off while the printer is making prints.
- Never bring any magnetized object near the printer.
- Never use flammable sprays, liquids or gases near the printer.
- Never modify the printer, as a fire or electrical shock could result.
- Never remove any panel or cover which is secured. The printer contains high voltage components which can cause electrical shock.
- Never tamper with the laser mechanism on laser-equipped models, as blindness or other injury may result.
- Never drop paper clips, staples or other small pieces of metal through the vents or other openings in the printer, as a fire or electrical shock can result.
- Never place containers of liquid on the printer. If liquids get inside the printer, they can cause fire or electrical shock. If a piece of metal or any liquid gets inside the printer, immediately turn the printer off, unplug the power cord and call your technical representative. A fire or electrical shock can result if the printer remains plugged in or is operated after metal or liquid gets inside.
- Never leave the printer running if it becomes unusually hot, or if smoke or an unusual odor or noise is detected. Should any of these conditions occur, immediately turn the printer off, unplug the power cord and call your technical representative. A fire or electrical shock can result if the printer remains plugged in under any of these conditions.
- Always insert the power plug all the way into the outlet.
- Always make sure that the outlet is visible, clear of the printer or printer cabinet.
- Always provide good ventilation when making a large number of continuous prints.
- Never pull on the power cord, and always hold the plug when unplugging the power cord. A damaged cord could result in a fire or cause an electrical shock.
- Never unplug the power cord with a wet hand, as it could cause an electrical shock.
- Always unplug the power cord before moving the printer. Moving the printer with the power cord plugged in can damage the cord resulting in a fire or causing an electrical shock.
- Always unplug the power cord when the printer is not going to be used for a long time.
- Never place a heavy object on the power cord, or pull or bend it, as a fire or electrical shock can result.
- Always ensure that the printer does not sit on or ride on the power cord or communications cable of other electrical equipment, as malfunctioning equipment or a fire could result.
- Always ensure that the power cord or communications cable of other electrical equipment does not become wedged into the printer mechanism, as malfunctioning equipment or a fire could result.

Using the Printer Properly

- Always use the correct power voltage, as improper voltage can cause a fire or electrical shock.
- Never use a multiple outlet adapter, as a fire or electrical shock can result.
- Should the power cord become damaged, immediately turn the printer off, unplug the power cord and call your technical representative. A damaged cord can result in a fire or cause an electric shock.
- If an extension cord is needed, use one with a greater rated capacity than the maximum power requirements of the printer. The use of an extension cord that falls short of supporting the maximum power requirements can result in overheating or a fire.
- Always unplug the printer whenever anything unusual is observed during operation. Make sure that the outlet is nearby and clear of the printer and furniture.

NOTE

= Locate the Printer in a Well Ventilated Room =

A negligible amount of ozone is generated during normal operation of this unit. An unpleasant odor may, however, be created in poorly ventilated rooms during extensive unit operation. For a comfortable, healthy, and safe operating environment, it is recommended that the room be well ventilated.

REMARQUE

= Placer le l'appareil dans une pièce largement ventilée =

Une quantité d'ozone négligeable est dégagée pendant le fonctionnement de l'appareil quand celui-ci est utilisé normalement. Cependant, une odeur désagréable peut être ressentie dans les pièces dont l'aération est insuffisante et lorsque une utilisation prolongée de l'appareil est effectuée. Pour avoir la certitude de travailler dans un environnement réunissant des conditions de confort, santé et de sécurité, il est préférable de bien aérer la pièce où se trouve le l'appareil.

Safety Information

SAFETY INFORMATION

This color printer is a digital printer which operates by means of a laser. There is no possibility of danger from the laser, provided the printer is operated according to the instructions in this manual.

Since radiation emitted by the laser is completely confined within protective housing, the laser beam cannot escape from the machine during any phase of user operation.

This machine is certified as a Class 1 laser product. This means the printer does not produce hazardous laser radiation.

LUOKAN 1 LASERLAITE KLASS 1 LASER APPARAT
--

CAUTION

The use of controls, adjustments or performance of procedures other than those specified in this manual may result in hazardous radiation exposure. Because of this, we strongly recommend that you operate your printer only as described in this documentation.

For United States Users:

This printer is certified as a Class 1 Laser product under the Radiation Performance Standard according to the Food, Drug and Cosmetic Act of 1990. Compliance is mandatory for Laser products marketed in the United States and is reported to the Center for Devices and Radiological Health (CDRH) of the U.S. Food and Drug Administration of the U.S. Department of Health and Human Services (DHHS). This means that the Printer does not produce hazardous laser radiation.

The label shown below indicates compliance with the CDRH regulations and must be attached to laser products marketed in the United States.

WARNING

Use of controls, adjustments or performance of procedures other than those specified in this manual may result in hazardous radiation exposure.

Internal Laser Radiation

Maximum Radiation Power:	26.79 μ W
Wave Length:	780 nm

Safety Information

For European Users:

WARNING

Use of controls, adjustments or performance of procedures other than those specified in this manual may result in hazardous radiation exposure.

This is a semiconductor laser. The maximum power of the laser diode is 26.79 μ W and the wavelength is 780nm.

For Denmark Users:

ADVARSEL

*Usynlig laserstråling ved åbning, når sikkerhedsafbrydere er ude af funktion.
Undgå udsættelse for stråling.*

Klasse 1 laser produkt der opfylder IEC825 sikkerheds kravene.

For Finland, Sweden Users:

VAROITUS

Laitteen Käyttäminen muulla kuin tässä käyttöohjeessa mainitulla tavalla saattaa altistaa käyttäjän turvallisuusluokan 1 ylittävälle näkymättömälle lasersäteilylle.

WARNING

Om apparaten används på annat sätt än i denna bruksanvisning specificerats, kan användaren utsättas för osynlig laserstråling, som överskrider gränsen för laser klass 1.

For Norway Users:

ADVERSEL

Dersom apparatet brukes på annen måte enn spesifisert i denne bruksanvisning, kan brukeren utsettes for usynlig laserstråling som overskrider grensen for laser klasse 1.

Dette en halvleder laser. Maksimal effekt till laserdiode er 26.79 μ W og bølgelengde er 780nm.

Laser Safety Labels

Label on printer surface

A laser safety label is attached to the outside of the printer as shown below.

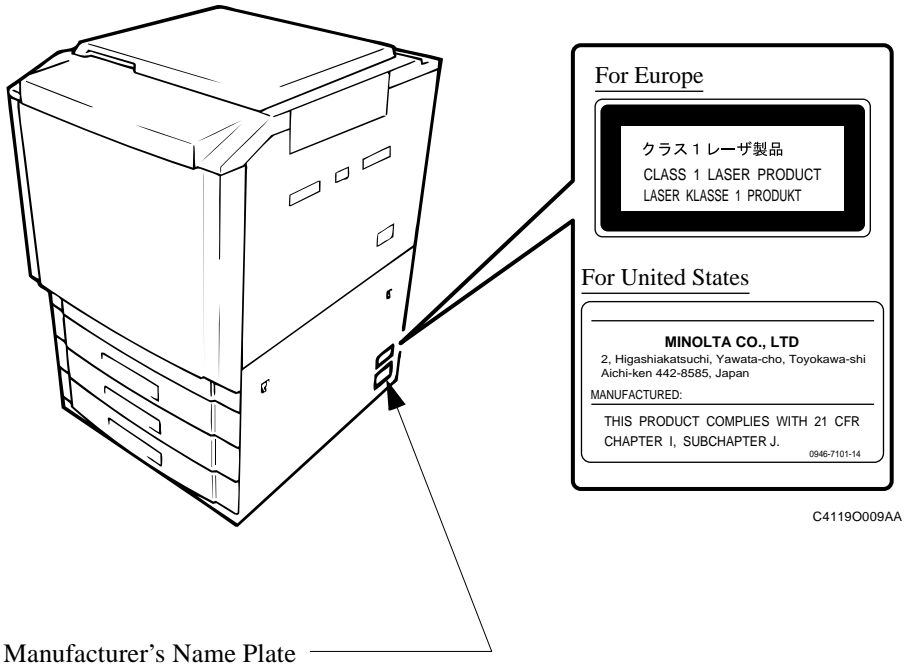

The Manufacturer's Name Plate is affixed at the position illustrated above.
Please write down the Model Name and Serial No. of your printer here, if necessary.

Model:
Serial No.:

Regulatory Information

For United States Users:

WARNING

This equipment has been tested and found to comply with the limits for a Class A digital device, pursuant to Part 15 of the FCC Rules. These limits are designed to provide reasonable protection against harmful interference when the equipment is operated in a commercial environment. This equipment generates, uses, and can radiate radio frequency energy and if not installed and used in accordance with the instruction manual, may cause harmful interference to radio communications. Operation of this equipment in a residential area is likely to cause harmful interference in which case the user will be required to correct the interference at his own expense.

The design and production of this unit conforms to FCC Regulations, and any changes or modifications must be registered with the FCC and are subject to FCC control. Any changes made by the purchaser or user without first contacting the manufacturer will be subject to penalty under FCC regulations.

FCC-F01

For Canada Users:

This Class A digital apparatus complies with Canadian ICES-003.

Cet appareil numérique de la classe A est conforme à la norme NMB-003 du Canada.

IC-F03

For European Users:

Thank you for choosing Minolta.

This operator's manual explains how to operate the color printer and replenish its supplies. It also gives some troubleshooting tips as well as general precautions to be observed when operating the color printer.

To ensure the best performance and effective use of your color printer, read this manual carefully until you familiarize yourself thoroughly with its operation and features. After you have read through the manual, keep it for ready reference.

Please use this manual as a quick and handy reference tool for immediately clarifying any questions which may arise.

CE Marking (Declaration of Conformity)

We declare under our sole responsibility that the color printer and options to which this declaration relates is in conformity with the specifications below. This declaration is valid for the area of the European Union (EU) only.

Product Type	Digital Full Color Printing Machine
Product Name	CF911PE
Options	C-101, AD-7
Standards	<p>Safety ^{*2} : EN 60 950 / 1992 (A1:1993, A2:1993, A3:1995, A4:1997) (Safety of information technology equipment, including electrical business equipment) EN 60825 / 1992 (A11:1996) (Radiation safety of laser products, equipment classification, requirements and user's guide)</p> <p>EMC ^{*1} : EN 55 022 (Class B) / 1994 (A2 : 1997) (Limits and method for measurement of radio disturbance characteristics of information technology equipment (ITE)) EN 50 082-1 / 1992 (Electromagnetic compatibility - Generic immunity standard Part 1: Residential, commercial and light industry) IEC 801-2 / 1991 (Electrostatic discharge requirement) IEC 801-3 / 1984 (Radiated electromagnetic field requirement) IEC 801-4 / 1988 (Electrical fast transient / burst requirement)</p> <p>Note : *1) EMC performance: This product was designed for operation in a typical office environment. *2) First year of labeling according to EC-directive 73/23/EEC and 93/68/EEC: 98</p>
EC Directives	<p>Safety : 73 / 23 / EEC and 93 / 68 / EEC EMC : 89 / 336 / EEC and 93 / 68 / EEC</p>

Technical Support

For United States and Canada Users:

Thank you for choosing Minolta quality. For over 30 years Minolta has been a leader on the forefront of office equipment technology and service. Our desire has always been to bring you highly reliable products. We pledge to continue to provide you, our customer, with our state of the art equipment, as well as full customer service for all our products. We look forward to a long healthy relationship with you and our company. If you have any questions or comments about Minolta, our product or service, please let us know. Our fax number is 800-237-8087 (for U.S.A. and Canada). Thank you again.

This operator's manual explains how to operate the color printer and replenish its supplies. It also gives some troubleshooting tips as well as general precautions to be observed when operating the color printer.

To ensure the best performance and effective use of your color printer, read this manual carefully until you familiarize yourself thoroughly with the it's operation and features. After you have read through the manual, keep it ready for reference.

Please use this manual as a quick and handy reference tool for immediately clarifying any questions which may arise.

MC-F01

Terms and Symbols for the Type of Printer Paper

A few special terms and symbols are used in this manual to designate the types of printer paper.

Feeding Direction (printer paper path)

In this system, printer paper is taken up from the left-hand side of the unit and fed through the unit toward the right-hand side, face-down onto the Exit Tray. In the figure below, the direction in which the printer paper is fed, as indicated by the arrow, is called the “feeding direction”.

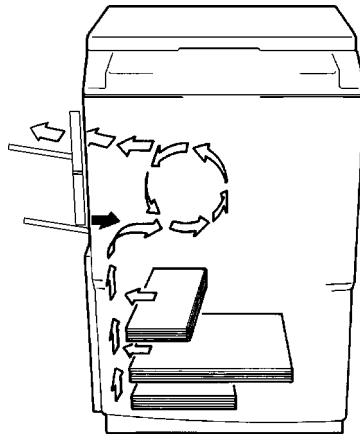

C41190002AA

“Width” and “Length”

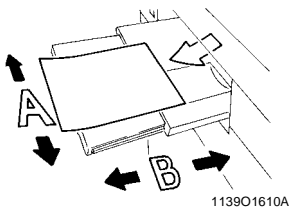

113901610A

When the size of the paper is described, side A is referred to as the “width” and side B as the “length”.

A: Width
B: Length

Terms and Symbols

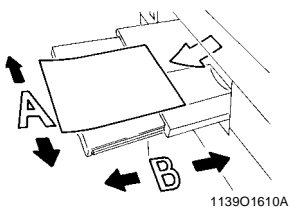

113901610A

<Lengthwise >

When the original or print has a “length” longer than its “width,” we call it “lengthwise” and use symbol “L” or “.

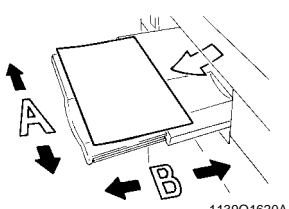

113901620A

<Crosswise >

When the original or print has a “length” shorter than its “width,” we call it “crosswise” and use symbol “C” or “.

x Contents

Organization

Chapters 1 through 3 contain the basic information for making prints.

Be sure to read these chapters before attempting to use your printer.

	Using the Printer Properly	i
	Safety Information	iii
	Regulatory Information.....	vi
	Technical Support	viii
	Terms and Symbols for the Type of Printer Paper	ix
Chapter 1	Safety Notes	1-1
	1. Installing the Printer	1-2
	Installation Site	1-2
	Power Source	1-2
	Space Requirements	1-2
	2. Precautions for Use	1-3
	Operating Environment.....	1-3
	Using the Unit Properly	1-3
	Moving	1-3
	Care of Printer Supplies	1-3
	Storage of Prints	1-4
Chapter 2	Getting to Know Your Printer	2-1
	1. System Overview	2-2
	System Overview	2-2
	2. Printer Parts and Accessories	2-3
	3. Turning ON and OFF	2-6
	Turning ON and OFF	2-6
	When the unit is turned ON	2-6
	Continuous Printing Precautions.....	2-7
Chapter 3	Printing Procedures	3-1
	1. Printing & Function Settings	3-2
Chapter 4	When a Message Appears	4-1
	1. When the Message "Load XX in any tray." Appears	4-2
	Paper Loading Procedures	4-2
	2. When the Message "Toner Near Empty" or "No XX Toner." Appears	4-4
	Replenishing Toner.....	4-4
	3. When "Paper Jam." Appears	4-6
	Misfeed Location	4-6
	4. When the Message "Fuser Oil Near Empty" or "No Fuser Oil." Appears	4-12
	5. When the Message "Please call Tech. Service. Cxxxx" Appears	4-12
	6. What Does Each Message Mean?	4-13
Chapter 5	Troubleshooting.....	5-1
	1. When This Type of Print is Produced	5-2
	2. Printer Malfunctions	5-3
	The printer is malfunctioning	5-3

Chapter 6	Miscellaneous	6-1
	1. Specifications	6-2
	Specifications	6-2
	2. Care of the Unit	6-5
	Cleaning	6-6
	3. Paper Size Table	6-6
	4. Index	6-8
	5. About this Manual	6-9

Chapter 1

Safety Notes

1. Installing the Printer

Installation Site

To ensure optimal safety and prevent possible malfunctions of the unit, install the printer in a location which meets the following requirements.

- ◆ A place away from a curtain or the like that may catch fire and burn easily.
- ◆ An area where there is no possibility of being splashed with water or other types of liquid.
- ◆ An area free from direct sunlight.
- ◆ A place out of the direct air stream of an air conditioner, heater, or ventilator.
- ◆ A well-ventilated place.
- ◆ A dry place.
- ◆ A dust-free location.
- ◆ An area not subject to undue vibration.
- ◆ A stable and level location.
- ◆ A place where ammonia or other organic gas is not generated.
- ◆ A place which does not put the operator in the direct stream of exhaust from the printer.
- ◆ A place which is not near any kind of heating device.

Power Source

The power source voltage requirements are as follows.

- ◆ Use a power source with little voltage fluctuation.
 - Voltage Fluctuation : Within $\pm 10\%$ (for U.S.A. and Canada)
 - Specified voltage $\pm 10\%$ (For EU)
 - Frequency Fluctuation : Within $\pm 0.3\%$ (For U.S.A. and Canada)
 - Specified frequency $\pm 3\text{Hz}$ (For EU)

Space Requirements

To ensure easy printer operation, supply replacement and service maintenance, observe the recommended space requirements detailed below.

- * Be sure to allow a clearance of 150 mm (6") or more at the back of the printer as there is a ventilation duct.

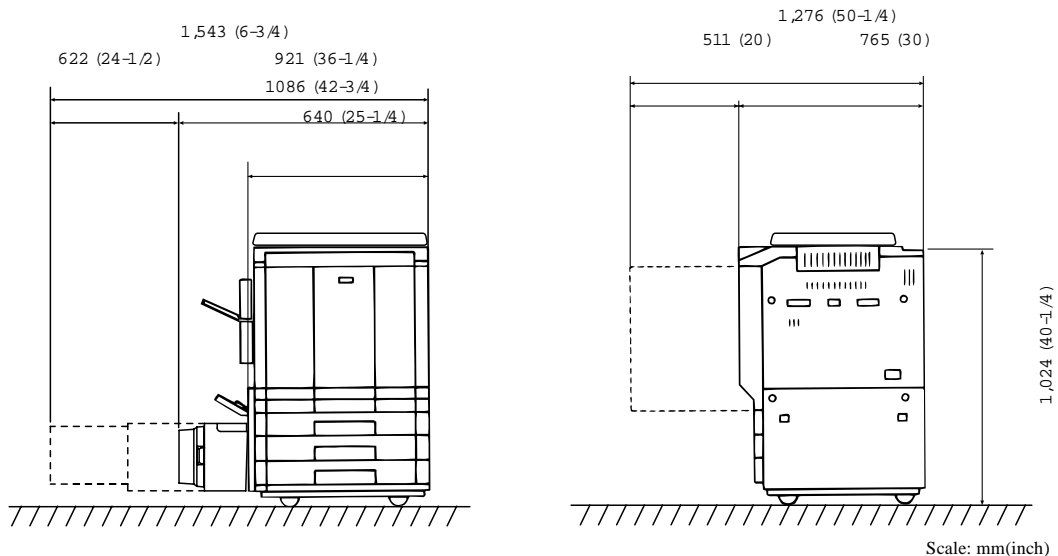

C4119O003AA

2. Precautions for Use

Operating Environment

The operating environmental requirements of the printer are as follows.

Temperature	: 10°C to 30°C (50°F to 86°F) with a fluctuation of 10°C (18°F) per hour.
Humidity	: 25% to 85% with a fluctuation of 20% per hour.

Using the Unit Properly

To ensure the optimum performance of the unit, follow the precautions listed below.

- ◆ NEVER place a heavy object on the unit or subject the unit to any shock.
- ◆ NEVER open any Doors, or turn OFF the unit while it is printing.
- ◆ NEVER bring any magnetized object or use flammable sprays near the unit.
- ◆ NEVER modify the unit as a fire or electrical shock could result.
- ◆ ALWAYS insert the Power Plug all the way into the outlet.
- ◆ ALWAYS make sure that the outlet is visible, clear of the unit or unit cabinet.
- ◆ ALWAYS provide good ventilation when producing a large number of continuous prints.

NOTE

= *Locate the Printer in a Well Ventilated Room* =

A negligible amount of ozone is generated during normal operation of this unit. An unpleasant odor may, however, be created in poorly ventilated rooms during extensive unit operation. For a comfortable, healthy, and safe operating environment, it is recommended that the room be well ventilated.

REMARQUE

= *Placer le l'appareil dans une pièce largement ventilée* =

Une quantité d'ozone négligeable est dégagée pendant le fonctionnement de l'appareil quand celui-ci est utilisé normalement. Cependant, une odeur désagréable peut être ressentie dans les pièces dont l'aération est insuffisante et lorsque une utilisation prolongée de l'appareil est effectuée. Pour avoir la certitude de travailler dans un environnement réunissant des conditions de confort, santé et de sécurité, il est préférable de bien aérer la pièce où se trouve le l'appareil.

Moving

If you need to transport the unit over a long distance, consult your Technical Representative.

Care of Printer Supplies

Use the following precautions when handling the unit supplies (toner, paper, etc.).

- ◆ Store the paper, toner and other supplies in a location free from direct sunlight and separate from any heating apparatus. Keep these supplies in a dry, clean environment.
- ◆ Store paper which has been removed from its wrapper but not loaded into the Drawer, in a sealed plastic bag in a cool, dark place.
- ◆ Keep supplies out of the reach of children.
- ◆ If your hands become soiled with toner, wash them with soap and water immediately.

Storage of Prints

- If prints are to be kept for a long time, keep them in a place which is not exposed to light to prevent fading.
- If an adhesive containing solvent (e.g., spray glue) is used to paste prints, the toner on the prints can melt.
- The color prints have a toner layer thicker than the normal black-and-white prints. When a color print is folded, therefore, the toner can be broken at the fold.

NOTE

This unit is equipped with a counterfeit prevention function that can cause slight noise in the printed image.

Chapter 2

Getting to Know Your Printer

1. System Overview

System Overview

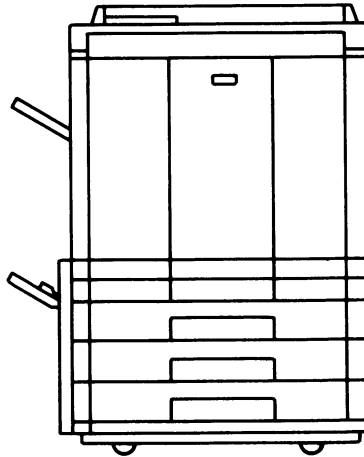

1144O003AB

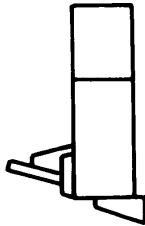

1144O184AA

**Duplex Unit
AD-7 <Option>**
Automatically turns over
one-sided prints to
produce two-sided prints.

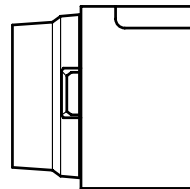

1154O028AA

**Large Capacity Cassette
C-101 <Option>**
Holds up to 1,000 sheets of
A4C (Letter C) printer paper
(80 g/m² or 21-1/4 lbs).

2. Printer Parts and Accessories

Outside the Unit

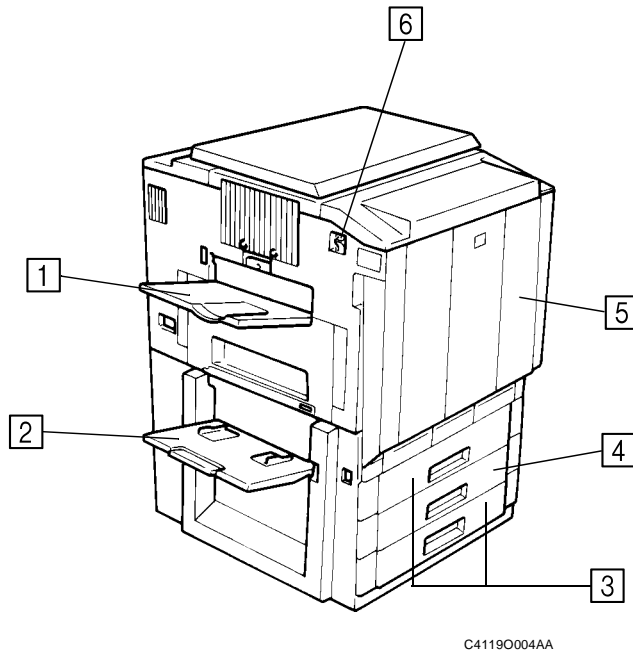

- | | | |
|----------|---------------------------------|--|
| 1 | Exit Tray: | Holds the prints ejected from the unit. |
| 2 | Manual Bypass Tray: | Use for manual feeding of printer paper into the unit. |
| 3 | Upper/Lower Tray: | Holds up to 500 sheets of paper. ☞ p. 4-2 |
| 4 | Middle Tray (Universal): | Holds up to 250 sheets of paper. ☞ p. 4-2 |
| 5 | Front Door: | Open to clear a paper misfeed or add toner. ☞ pp. 4-4, 4-9 |
| 6 | Power Switch: | Use to turn the printer ON and OFF. ☞ p. 2-6 |

Inside the Unit

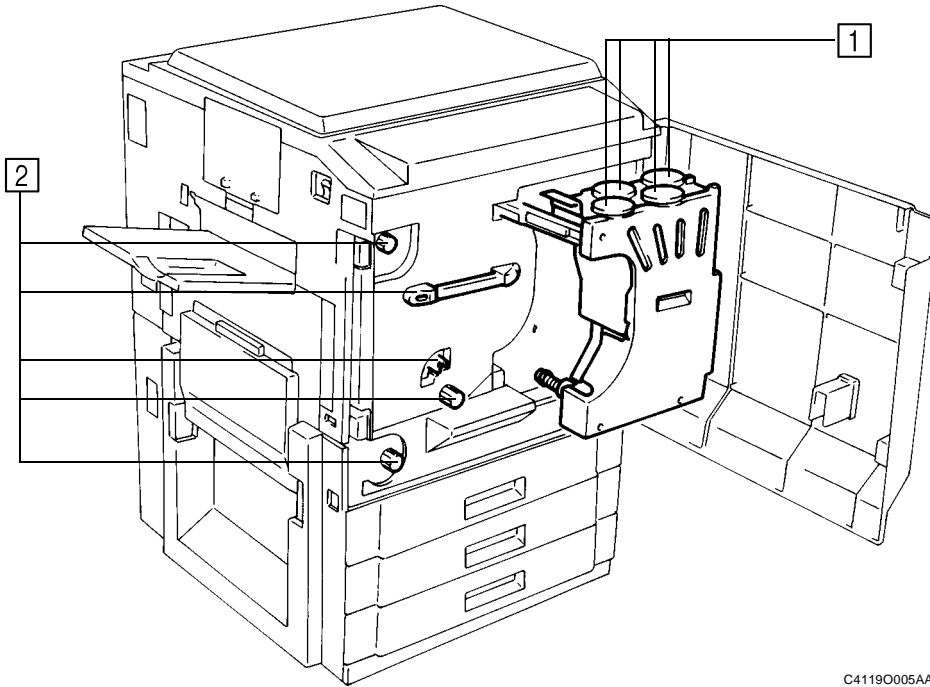

C41190005AA

1 Toner Hopper Lid:

Open when adding toner. ↗ p. 4-4

2 (M1) - (M9):

Operate these parts to clear misfed sheets of paper. ↗ p. 4-7 to 4-9

Options

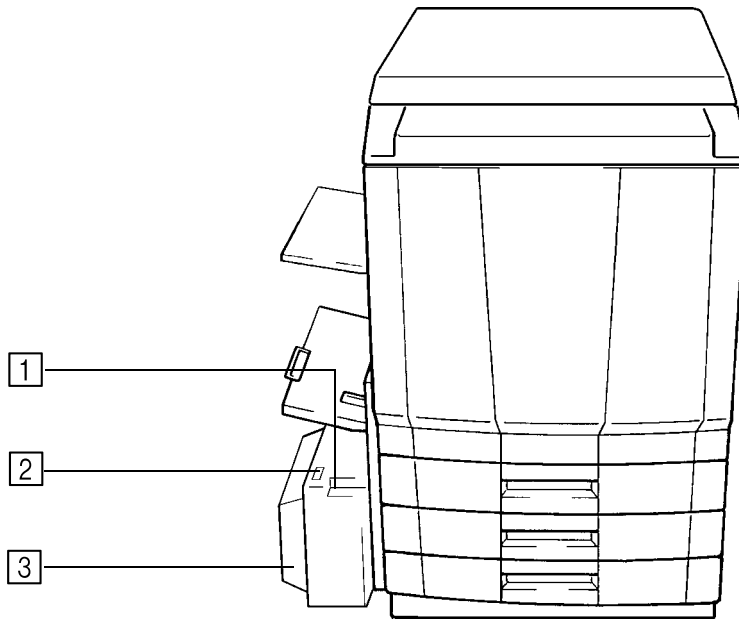

C41190006AA

Large Capacity Cassette

- 1 **Cassette Release Lever:** Use to release the cassette from the unit when it is necessary to clear a misfeed.
- 2 **Paper Plate Descent Key:** Press to lower the paper plate.
- 3 **Cassette Door:** Open to add paper or clear a misfed sheet of paper. p. 4-10

3. Turning ON and OFF

Turning ON and OFF

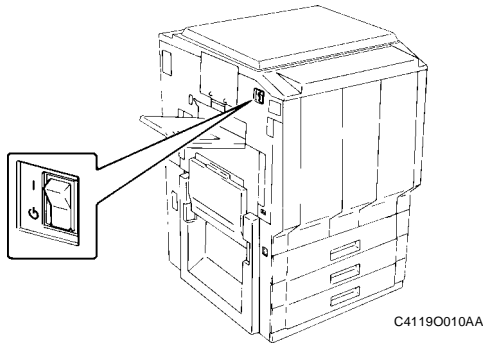

- Turning the printer ON
Press the Power Switch to the **I** (ON) position.
- Turning the printer OFF
Press the Power Switch to the **⏻** (OFF) position.

When the unit is turned ON

The printer icon on the print station manager screen changes as follows when the power is turned ON.

- (1) While the printer self-test operation and warm-up, off-line, printer busy, printer in sleep are performed automatically, the indicator will turn yellow.



- (2) If a printer system error occurs, the indicator will turn red.

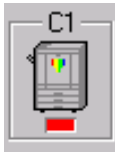

- *Click the this icon, displayed Error Messages on the screen of printer driver summary.
- *Red + stripe is power off of the CF911PE.

- (3) When the printer enters the print-ready mode, the indicator will turn green.

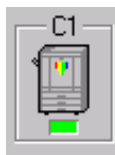

- *Dark green is power off of the PrintLink, or the unconnect the interface cable.

However, the printing operation cannot be performed even if data from the computer is sent at this time. A warm-up time of approximately nine minutes (at a room temperature of 20°C (68°F)) is required before printing can be performed.

NOTE

If the fusing temperature drops excessively during a multi-print cycle, there is a possibility that the printing speed will be reduced. The printing speed will automatically return to normal when the fusing temperature rises enough to ensure good fusing performance.

Continuous Printing Precautions

The printing operation stops for the following intervals and the transfer drum cleaning operation is performed for approximately 40 seconds to maintain optimal performance of the color printer. Wait a moment when this condition occurs.

- Full-color or monochrome printing:..... Every 24 prints for continuous printing and 48 prints for non-continuous printing.*
- Black-and-white mode: Every 56 prints for continuous printing and 48 prints for non-continuous printing.*

* These figures vary according to the selected print size and other setting conditions.

Chapter 3

Printing Procedures

1. Printing & Function Settings

Printing & Function Settings

Refer to the following manuals for the procedure about a printing and/or function settings.

- ◆ PrintStation Manager Reference Manual
- ◆ PrintStation Manager Configuration Reference Manual
- ◆ Raster Image Processor Reference Manual
- ◆ MicroSpool Reference Manual
- ◆ MicroSpool Configuration Reference Manual

Chapter 4

When a Message Appears

1. When the Message “Load XX in any tray.” Appears

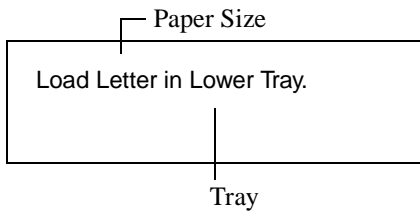

The message shown on the left is displayed when the Tray currently selected for use runs out of paper. The current print cycle is interrupted and you cannot start a new print cycle. Load the tray with paper by performing the following procedure:

NOTE

Only the following type of paper can be loaded in the tray. Use of paper recommended by our company is encouraged to maintain a standard level of print quality and prevent paper misfeeds.

- Paper weight: 64g/m² to 105g/m² (17 lbs. to 28 lbs.)
- Size: A3 lengthwise to A5 lengthwise
(11"×17" lengthwise to Invoice lengthwise)

Thick paper (Heavy Stock 2) and OHP transparencies cannot be loaded in the tray.

Paper Loading Procedures

Upper and Lower Trays

- 1 Slide the Tray out.
- 2 Load the paper stack into the Tray so that its front side (the side facing up when the package was unwrapped) **faces down**. Then, slide the Tray back in.

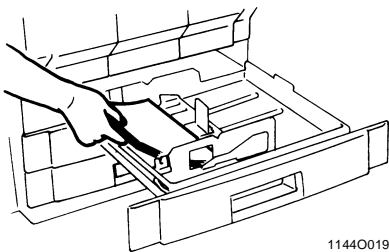

1144O019AA

NOTES

- Up to 500 sheets of paper (80g/m²) (21-1/4 lbs.) can be loaded.
- The paper should be loaded no higher than the ▼ (Max. Level Indicator).

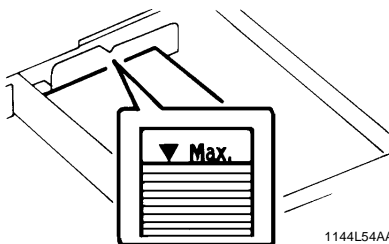

1144L54AA

Middle Tray

- 1 Slide the Tray out.
- 2 Load the paper stack into the Tray so that its front side (the side facing up when the package was unwrapped) faces down. Then, slide the Tray back in.

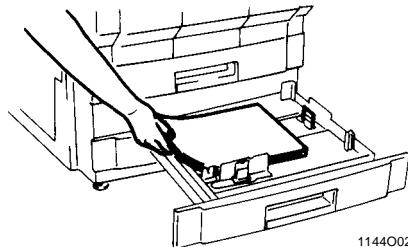

1144O022AA

NOTES

- Up to 250 sheets of paper (80g/m²) (21-1/4 lbs.) can be loaded.
- The paper should be loaded no higher than the ▼ (Max. Level Indicator).

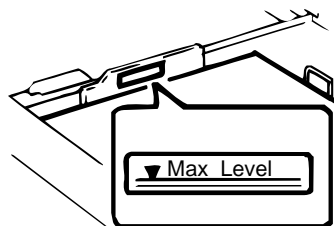

1144L044AA

Changing the Paper Size for the Middle Tray (Universal Tray)

- 1 Grasp the tab of the Edge Guide and slide it to the size of the paper to be loaded. Pressing the plastic part of the Trailing Edge Stop, slide it to the size of the paper to be loaded.

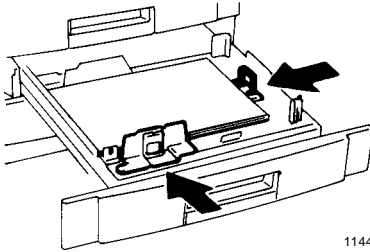

1144O023AA

NOTE

When loading A3 (11"×17") paper: Move the Trailing Edge Stop all the way to the right. Then, pinch the Lever as shown and remove it from the Stop. Next, fit the Lever into position as shown.

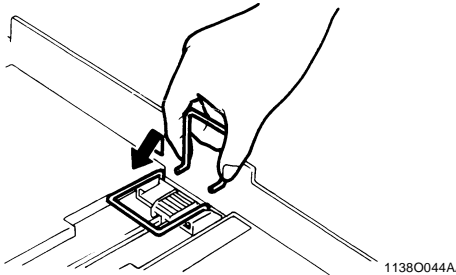

1138O044A

When loading Inch size paper

Flip the Switch, located in the right rear corner of the Tray, to “Inch”.

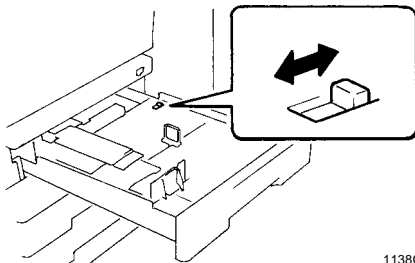

1138O606EA

Large Capacity Cassette

- 1 Grasping the Door Lock Release Lever, open the Cassette Door.

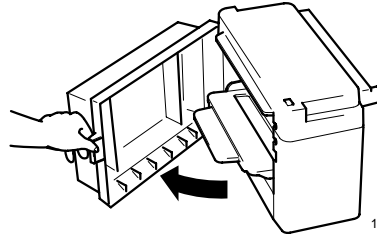

1154O030AA

When adding paper to a partially loaded Cassette, press the paper Plate Descent Key to lower the Paper Plate before opening the Cassette Door.

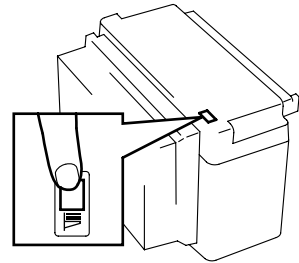

1154O031AA

- 2 Place the paper stack onto the Paper Plate so that its front side faces up and close the Cassette Door.

*This causes the Paper Plate to rise automatically.

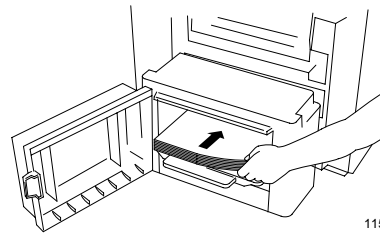

1154O032AA

NOTES

- Make sure that the leading edge of the paper stack is pressed tightly up against the Guide Plate on the take-up side of the Cassette.
- The paper should be loaded no higher than the ▼ (Max. Level Indicator).

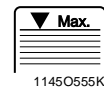

1145O555KA

- The Paper Plate may not ascend if the Cassette Door is not closed completely. Be sure to close the Door completely.

2. When the Message “Toner Near Empty” or “No XX Toner.” Appears

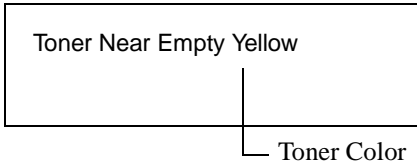

The message shown on the left appears when toner will run out soon. You can still make prints, but the image density will become lighter and lighter. It is recommended that you replenish the toner as soon as possible for this reason.

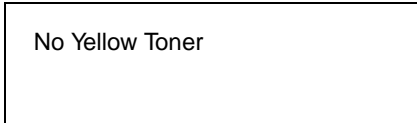

When toner has run out, the message shown on the left is displayed and you can no longer start a new print cycle. Follow the procedure described below to replenish the toner.

Replenishing Toner

- 1 Open the Front Door.
(Example: Yellow Toner is empty.)

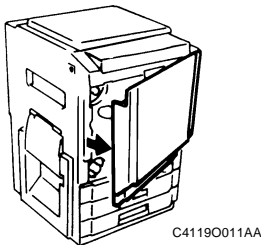

- 2 Slide out the Toner Hopper Unit.

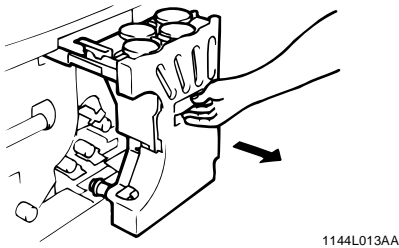

- 3 Sharply tap the new Toner Bottle against a desk or other hard object four to five times. Then turn the Toner Bottle upside down and tap it the same way again.

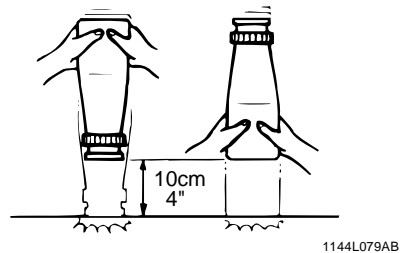

- 4 Shake the Toner Bottle well.

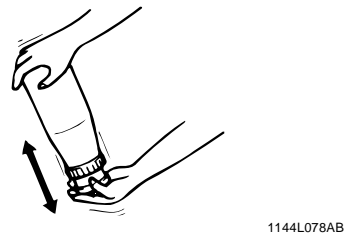

2. When the Message “Toner Near Empty” or “No XX Toner.” Appears

- 5** Remove the bottle cap and peel off the seal.



1144L016AA

- 6** Open the Toner Hopper Lid.

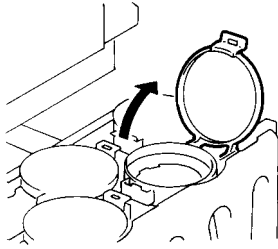

1144L014AA

NOTE

Make absolutely certain that the color of the toner matches the color of the Toner Hopper Lid.

- 7** Align the tab on the Bottle with the cutout in the Toner Receptacle and turn the Bottle clockwise until it stops.

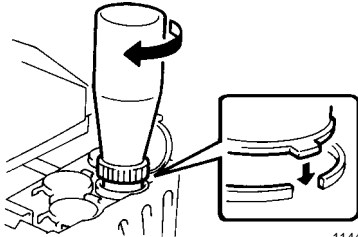

1144L017AA

- 8** After the toner stops falling in (approx. 60 seconds), tap the Bottle a few times to ensure that all the toner falls into the Hopper.

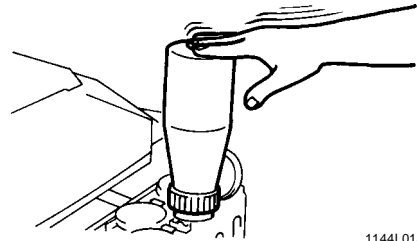

1144L018AA

- 9** Making sure that the toner has emptied completely, turn the Bottle counterclockwise and lift it out of the Receptacle. Close the Toner Hopper Lid.

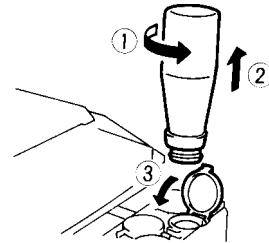

1144L019AA

NOTE

Please wait for a while after the toner has fallen in completely. If not, toner powder may be blown up from the Toner Hopper.

- 10** Slide the Toner Hopper Unit back in and close the Front Door.

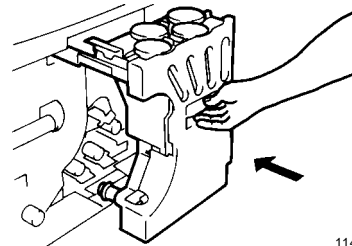

1144L020AA

- 11** Use the same procedure to add toner for the other three Main Hoppers.

3. When the Message “Paper Jam.” Appears

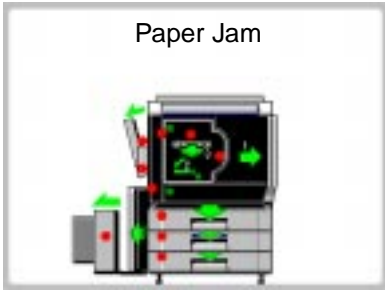

If a paper misfeed occurs during a print cycle, the message shown on the left is displayed and that particular print cycle is stopped in the middle of operation.

Clear the misfed sheet of paper according to the procedure given below.

Misfeed Location Displays

Different procedures are used to clear a misfed sheet of paper depending on the location. First, isolate the location, then clear the misfeed following the procedure applicable to where the misfeed occurred.

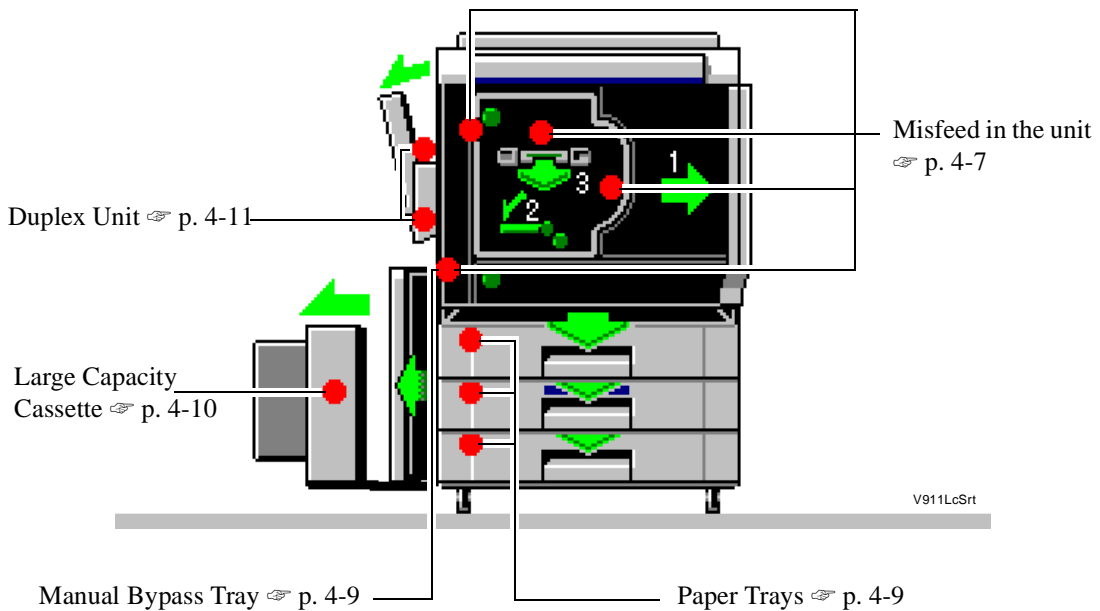

Misfeed in the unit

- 1 Open the Left Door (L1).

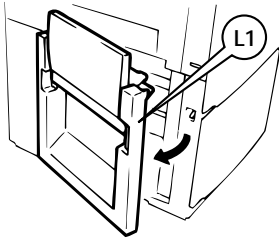

1144O548AA

- 2 Pull out the sheet of paper from the Transport Section.

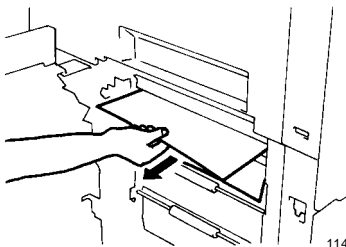

1144L022AA

- 3 Raise the Guide Plate (M2), turn Knob (M1) and pull out the sheet of paper.

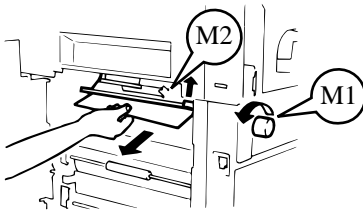

1144L023AA

- 4 Press down Guide Plate (M3) and pull out the sheet of paper.

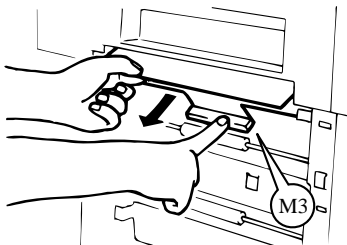

1144L024AA

- 5 Close the Left Door (L1).

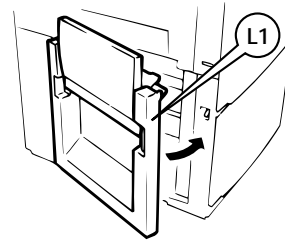

1144O549AA

- 6 Open the Front Door.

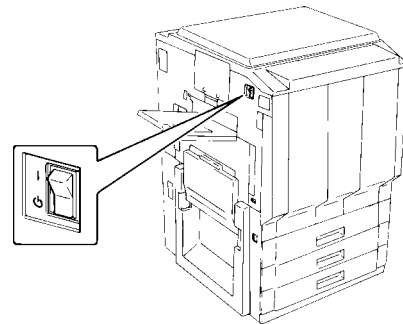

C4119O010AA

- 7 Turn Lever (M4) to the left. Press Guide Plate (L2), turn Knob (M5) and pull out the sheet of paper.

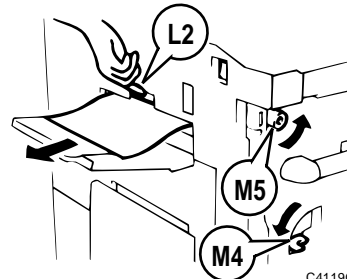

C4119O016AA

- 8 Grasp Lever (M6) and slide out the Transfer/Fusing Unit.

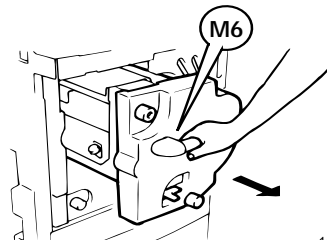

1144L027AB

3. When the Message “Paper Jam.” Appears

- 9** Grasp the Fusing Unit Lever (M7) and open the Fusing Unit.

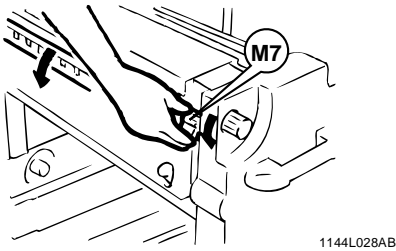

1144L028AB

⚠ CAUTION

DO NOT touch any parts except the paper as the Fusing Unit and its surrounding areas are extremely hot.

- 10** While turning Knob (M5), pull out the sheet of paper and close the Fusing Unit.

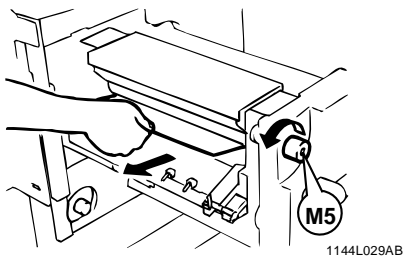

1144L029AB

- 11** Pull out the sheet of paper from the Upper Area of the Transfer/Fusing Unit.

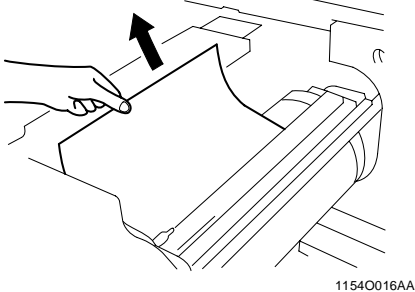

1154O016AA

- 12** While turning Knob (M9), remove the sheet of paper. If the paper adheres to the Transfer Film, gently disengage the leading edge of the paper and remove it, being careful not to damage the Transfer Film.

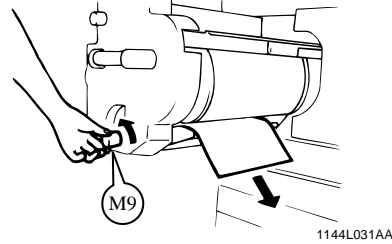

1144L031AA

- 13** Press down on the Roller and remove any sheet of paper that is inside the unit.

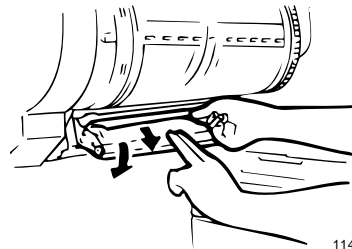

1144L069AA

- 14** Slide the Transfer/Fusing Unit back into the printer and turn the Release Lever (M4) to the right.

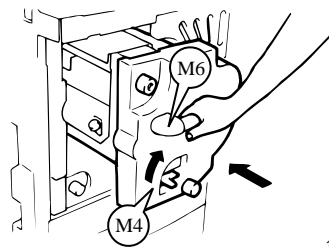

1144L032AB

- 15** Close the Front Door.

Paper Trays

- 1 Open the Left Door (L1) and pull out the sheet of paper from the Transport Section.

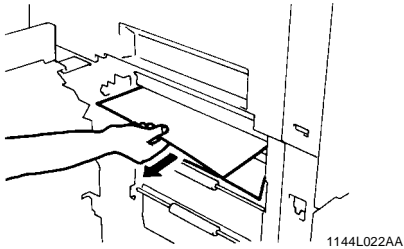

- 2 Close the Left Door (L1).
- 3 Slide the Tray out.

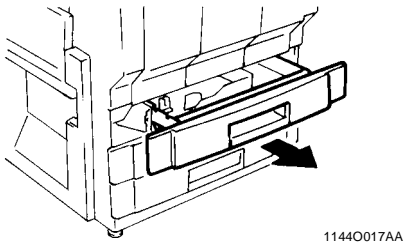

- 4 Unload the paper stack from the Tray. Fan the paper thoroughly and reload it in the Tray.

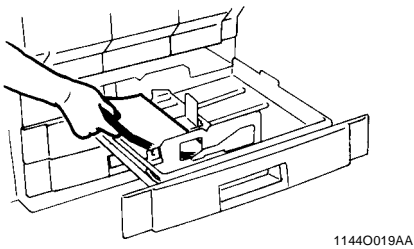

- 5 Slide the Tray back in.
- 6 Open the Front Door and then close it to reset the misfeed message on the Control Panel.

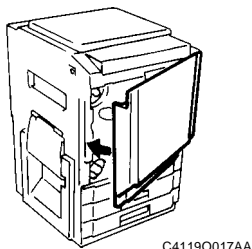

Manual Bypass Tray

- 1 Unload the paper stack from the Manual Bypass Tray. Then open the Left Door (L1).

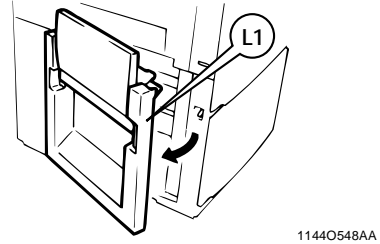

- 2 Pull out the sheet of paper. Raise the Guide plate (M2), turn knob (M1) and pull out the sheet of paper and close the Left Door.

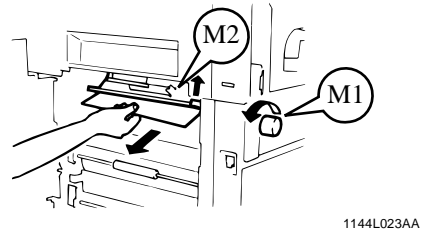

- 3 Fan the paper stack thoroughly and place it back on the Tray.

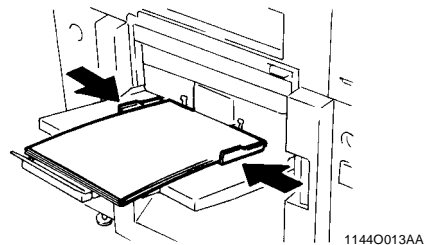

- 4 Open the Front Door and then close it to reset the misfeed message on the Control Panel.

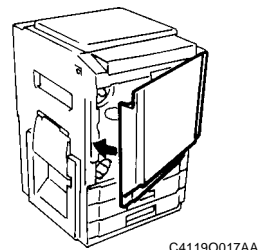

3. When the Message “Paper Jam.” Appears

Large Capacity Cassette

1 Press the Paper Descent Key.

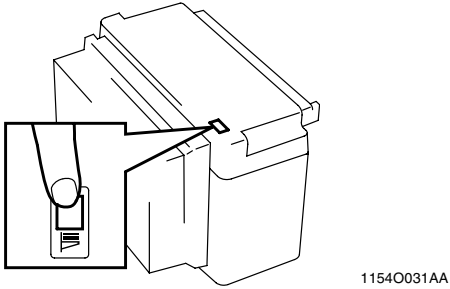

2 Grasping the Door Lock Release Lever, open the Cassette Door and remove the sheet of paper.

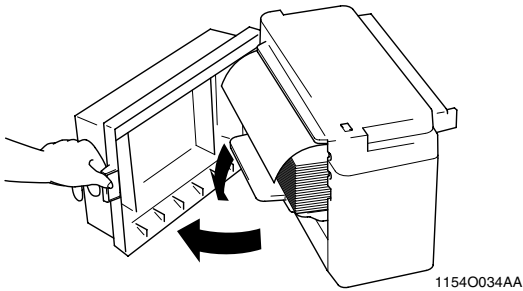

3 Close the Cassette Door.

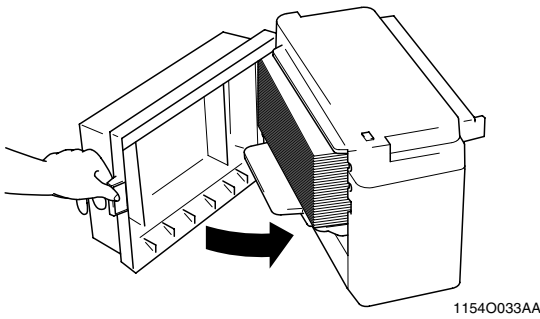

4 Slide the cassette away from the main unit.

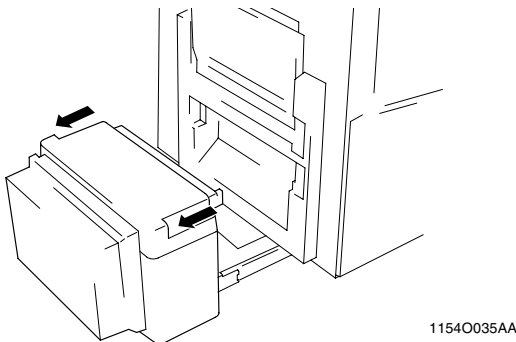

5 Remove the sheet of paper.

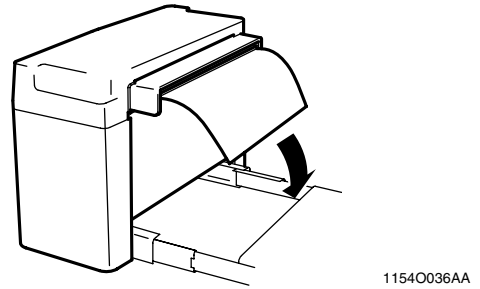

6 Slide the Cassette back against the printer.

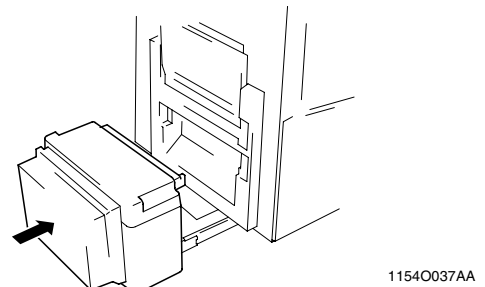

Duplex Unit

- 1 Grasping the Lock Release Lever, open the Duplex Unit.

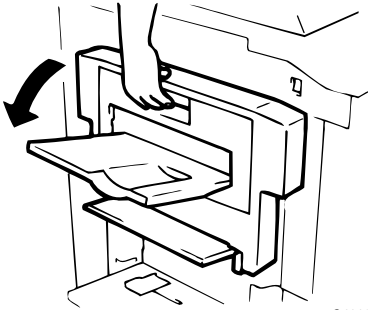

C41190018AA

- 2 Open the Misfeed Removal Guide (D) and remove the sheet of paper.

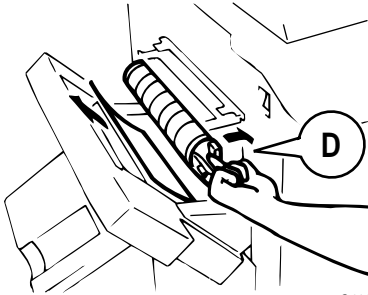

C41190019AA

- 3 Close the Duplex Unit.

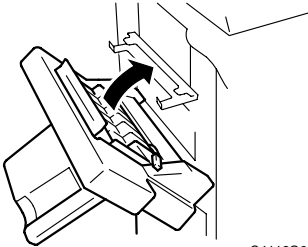

C41190020AA

4. When the Message “Fuser Oil Near Empty” or “No fuser oil.” Appears

Fuser

Fuser oil near empty

The message shown on the left appears when the Fuser Oil is running out. You can still make prints, but it is recommended that you replenish the Fuser Oil as soon as possible.

No fuser oil

When No Fuser Oil, the message shown on the left appears and you can no longer start a new print cycle. To replenish the Fuser Oil, **call your technical representative.**

5. When the Message “Please call Tech. Service. Cxxxx.” Appears

Please call Tech. Service. Cxxxx

When the message “**Please call Tech. Service. Cxxxx**” is appears on the message screen, the image stabilization function of the unit has malfunctioned. **Contact your Tech. Rep.**

IMPORTANT

When you contact your Technical Representative, inform him/her of the number of items which are displayed “Cxxxx”.

6. What Does Each Message Mean?

What Does Each Message Mean?

Message	Cause	Action
“Com error”	The Micro press is not receive ACK of the printer.	The interface cable is not connected.
“Error toner collecting bottle full”	The Waste Toner Collecting Bottle is full and the unit is unable to produce prints.	Call your technical representative.
“Front door or Left door open”	A unit door is left open or an option is not attached properly and the unit is unable to produce prints.	The printer’s front door and/or left door is open. The Printer will resume printing when the door is closed.
“Fuser oil empty”	The Fuser Oil needs to be replenished and the unit is unable to produce prints.	Call your technical representative.
“Fuser oil near empty”	The Fuser Oil is running out.	Call your technical representative.
“Load XX in any tray”	The currently selected Tray has run out of paper.	Load the Tray with paper size XX. ☞ p. 4-2
“Near trouble at p-xx.”	A malfunction occurred in the image stabilization control or other function.	Call your technical representative. Inform the near trouble code (p-xx) that is displayed.
“Paper Jam”	A paper misfeed occurs.	Clear the misfeed sheet.
“Plase call tech. Service. Cxxxx”	The unit malfunctioned and is unable to produce prints.	Call and inform your Technical Representative of the trouble code message on the screen.
“PostScript error”	A PostScript error occurs while a job is processing.	With utility, it appears on the PC with an alert icon next to it. The user can double-click the icon to display the error message.
“Toner empty”	Toner of the displayed color has run out and the unit is unable to produce prints.	Replenish toner. ☞ p. 4-4
“Toner hopper unset”	The toner hopper is not set securely and the unit is unable to produce prints.	Check the toner hopper. ☞ p. 4-4
“Toner near empty”	This message is displayed when toner will run out soon.	Replenish toner ☞ p. 4-4
“Waste toner bottle unset”	The current toner bottle is not set securely and the unit is unable to produce prints.	Call your technical representative.
“Waste toner near full”	The waste Toner Collecting Bottle is almost full.	Call your technical representative. Canceled when turning the power Off and On.

6. What Does Each Message Mean?

NOTE



For all other messages, see the Appendix A: Printer Messages of the Print Station User Guide.

Chapter 5

Troubleshooting

1. When This Type of Print is Produced

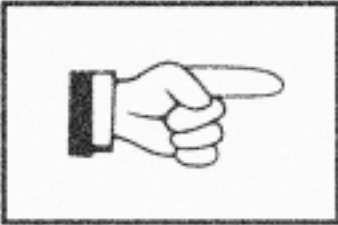
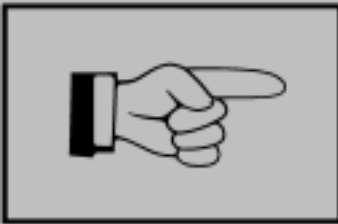
When there is a problem with the print image quality, check both the print size and printer driver options.

Print Image Condition	Possible Cause	Action
The print image is too light or the color is light.  1074O108	Is the printer driver set on the lighter side? Is “No Toner” displayed on the message display? Is the paper damp?	Check the printer driver setting. Refer to the Raster Image Processor Reference Manual. Replenish the toner. ☞ p. 4-4 Replace the paper. ☞ p. 4-2
The print image or the color is dark.  1074O109	Is the print driver set too dark?	Check the printer driver setting. Refer to the Raster Image Processor Reference Manual.
The print image is fuzzy.  1074O110	Is the paper damp?	Replace the paper. ☞ p. 4-2

2. Printer Malfunctions

The printer is malfunctioning.

Printer Condition	Check for:	Action
Printing cannot be performed even if data is sent from the computer.	There is some type of malfunction.	Perform the countermeasures indicated by the messages on the message display.
	Immediately after the main switch is turned ON, the printer remains in the warm-up mode.	After the main switch is turned ON, it takes approximately nine minutes until printing can be performed. Please wait.
	The printer power is not supplied.	Check the connection cable and connection conditions.
	Are the printer port and protocol parameters set correctly in the network setup?	Check the network settings.
	Is the printer driver set correctly?	Check the name and settings of the printer driver that is used.
The printer power is not supplied.	Is the power cord disconnected from the wall outlet?	Plug the power cord securely into the wall outlet.
	Is the breaker switched OFF for the power that is supplied to the printer?	Set the breaker to ON.

If these procedures do not correct the problem, contact your Technical Representative.

Chapter 6

Miscellaneous

1. Specifications

Specifications

Printer Main Unit	
Type	Console type printer
Photoconductor	OPC
Printing System	Electrostatic Dry Powdered Image Transfer to Plain Paper
Developing System	Micro-Toning System
Fusing System	Lamp-Heated Roller
Resolution	400 dpi
Paper Type	Tray Feeding : Plain paper (64 to 90g/m ²), (20 lbs. to 24 lbs.) Heavy Stock 1 (91 to 105g/m ²) (24 lbs. to 28 lbs.) Manual Feeding : Plain paper (64 to 90g/m ²), (20 lbs. to 24 lbs.) Heavy Stock 1 (91 to 105g/m ²), (24 lbs. to 28 lbs.) Heavy Stock 2 (106 to 157g/m ²), (50 lbs to 60lbs. cover) OHP Transparencies (recommended by us)
Paper Size	Upper/Lower Trays : A3L, B4L, A4L, A4C, B5L, B5C, A5L 8" × 13"L (203mm × 330mm), 8" × 10"L (203mm × 254mm), 8-1/4" × 13"L (210mm × 330mm) (11"×17"L, 11"×14"L, 10"×14"L, LegalL, G.LegalL, Foolscap (9-1/4"×14"L, 8-2/3"×13"L, 8-1/4"×13"L, 8-1/4"×11-3/4"L), (LetterL, LetterC, G.LetterL, G.LetterC, InvoiceL) Middle Tray : A3L, B4L, A4L, A4C, B5L, B5C, A5L (11"×17"L, LegalL, LetterL, LetterC, InvoiceL) Manual Bypass Tray : A3 Wide L (305mm × 457mm), A3L, B4L, A4L, A4C, B5L, B5C, A5L, A6L 8-1/4" × 13"L (210mm × 330mm) (12"×18"L, 11"×17"L, LegalL, LetterL, LetterC, InvoiceL) Crosswise: 148mm to 297mm (5-3/4" to 11-3/4") Lengthwise: 182mm to 432mm (7-1/4" to 17")
Tray Capacity	Upper/Lower Trays (Fixed size type) : 500 sheets (80g/m ²) (21-1/4 lbs.) Middle Tray (Universal type) : 250 sheets (80g/m ²) (21-1/4 lbs.) Manual Bypass Tray : 50 sheets (Plain Paper, Heavy Stock 1) : 20 sheets (Heavy Stock 2, OHP Transparencies)
Warm-up Time	Approx. 9 minutes at ambient temperature of 20°C/68°F
First Print	(in Full Size Mode using A4 crosswise paper and Upper Tray) Full-color : Less than 30 sec. Black : Less than 14 sec.
Print Speed (Approx. printings/ minute)	Full-color : 6 printings/min. (A4C) (LetterC) 3 printings/min. (A3L) (11"×17"L) 3 printings/min. (B4L) (10"×14"L) Black : 23 printings/min. (A4C) (LetterC) 11 printings/min. (A3L) (11"×17"L) 11 printings/min. (B4L) (10"×14"L)
Power Requirements	120V/60Hz, 220-240V/50-60Hz
Power Consumption	1.5 kW (Max.)
Dimensions	Width : 640mm (25-1/4") Depth : 765mm (30") Height : 994mm (39-1/4") (Up to Original Cover surface)
Space Requirement	826mm (32-1/2") (Width) × 765mm (30") (Depth)
Weight	215kg (474 lbs.)

Large Capacity Cassette C-101	
--------------------------------------	--

Kinds of Paper	Plain paper (60 to 90g/m ²) (16 lbs. to 24 lbs.), Recycled paper
Paper Size	A4C, Letter C
Capacity	1,000 sheets (80g/m ²) (21-1/4 lbs.)
Power Source	Supplied from the printer.
Power Consumption	30W or less
Dimensions	Width : 358mm (14") Depth : 446mm (17-1/2") Height : 289mm (11-1/2")
Weight	10.7kg (23-1/2 lbs.)

1. Specifications

Duplex Unit AD-7

Kinds of Paper	Plain paper: 60 to 90g/m ² (16 lbs. to 24 lbs.)
Print Paper Size	A3L to A5L (11"×17"L to InvoiceL)
Capacity	1-sided Up to 99 prints (A4C, A5L) (LetterC, InvoiceL) Up to 2 prints (A3L, A4L) (11"×17"L, LegalL, LetterL) 2-sided Up to 2 prints (A4C, A5L) (LetterC, InvoiceL) Up to 2 prints (A3L, B4L, A4L) (11"×17"L, LegalL, LetterL) Book: 99 prints
Power Source	DC24V, ±5% supplied from printer
Power Consumption	30W or less
Dimensions	Width : 121mm (4-3/4") Depth : 536mm (21") Height : 345mm (31-1/2")
Weight	7.0kg (15-1/2 lbs.) (Excluding Mounting Brackets)

2. Care of the Unit

Cleaning

Turn the Printer Power Switch OFF when cleaning.

Housing

Wipe the surface of the Housing clean with a soft cloth dampened with mild home detergent.

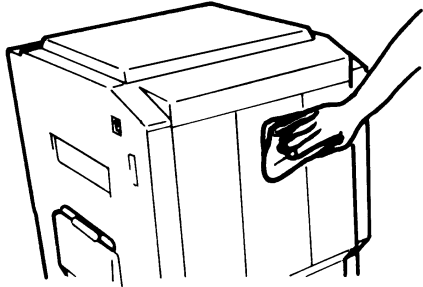

C4119O021AA

Front Door

Wipe the inside of the Front Door clean with a soft, dry cloth.

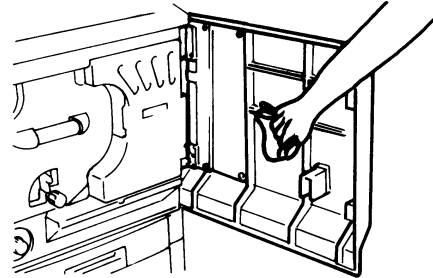

1144O027AA

3. Paper Size Table

Name	Size (Metric)	Size (Inch)
A3	297 mm × 420 mm	11-3/4" × 16-1/2"
B4	257 mm × 364 mm	10" × 14-1/4"
A4	210 mm × 297 mm	8-1/4" × 11-3/4"
B5	182 mm × 257 mm	7-1/4" × 10"
A5	148 mm × 210 mm	5-3/4" × 8-1/4"
B6	128 mm × 182 mm	5" × 7-1/4"
A6	105 mm × 148 mm	4-1/4" × 5-3/4"
POST CARD	100 mm × 148 mm	4" × 5-3/4"

Name		Size (Inch)	Size (Metric)
LEDGER		11" × 17"	279 mm × 432 mm
11" × 14"		11" × 14"	279 mm × 356 mm
COMPUTER		10-1/8" × 14"	257 mm × 356 mm
10" × 14"		10" × 14"	254 mm × 356 mm
9-1/4" × 14"		9-1/4" × 14"	236 mm × 356 mm
LEGAL		8-1/2" × 14"	216 mm × 356 mm
FOOLSCAP	GOVERNMENT LEGAL	8-1/2" × 13"	216 mm × 330 mm
FOOLSCAP		8" × 13"	203 mm × 330 mm
FOOLSCAP		8-2/3" × 13"	220 mm × 330 mm
FOOLSCAP	FOLIO	8-1/4" × 13"	210 mm × 330 mm
8-1/4" × 11-3/4"		8-1/4" × 11-3/4"	210 mm × 301 mm
LETTER		8-1/2" × 11"	216 mm × 279 mm
GOVERNMENT LETTER		8" × 10-1/2"	203 mm × 267 mm
QUARTO		8" × 10"	203 mm × 254 mm
STATEMENT	INVOICE	5-1/2" × 8-1/2"	140 mm × 216 mm

4. Index

Index

A

AD-7 pp. 2-2, 6-4

C

C-101 p. 6-3
Cleaning p. 6-5
Crosswise p. ix

D

Duplex Unit pp. 2-2, 4-6, 4-11, 6-4

E

Environment p. 1-3
Exit Tray p. 2-3

F

Feeding Direction p. ix
Front Door pp. 2-3, 4-4, 4-9, 6-5
Fuser Oil p. 4-15
Fuser Oil Near Empty p. 4-12
Fusing Unit p. 4-8

H

Housing p. 6-5

I

Inside the unit p. 2-4
Installing the Printer p. 1-2

J

Jam → Misfeed

L

Large Capacity Cassette pp. 2-2, 2-5, 4-3, 4-6,
4-10, 6-3
Left Door p. 4-9
Length p. ix
Lengthwise p. ix
LOAD IN ANY TRAY p. 4-2

Lower Tray pp. 2-3, 4-2

M

Manual Bypass Tray pp. 2-3, 4-9
Message Appears p. 4-1
Middle Tray pp. 2-3, 4-2, 4-3
Miscellaneous p. 6-1
Misfeed Location p. 4-6
Moving p. 1-3

N

No Toner p. 4-4

O

Options p. 2-5
Outside the unit p. 2-3

P

Paper Loading p. 4-2
Paper Plate Descent Key p. 2-5
Paper Size p. 6-6
Paper Tray pp. 2-3, 4-2, 4-9
Power Source p. 1-2
Power Switch p. 2-3
Print Image Condition p. 5-2
Printer Condition p. 5-3
Printer Main Unit p. 6-2
Printing & Function Settings p. 3-2

R

Replenishing Toner p. 4-4
Replenishing the Fuser Oil p. 4-14

S

Safety Information p. iii
Safety Label p. v
Safety Notes p. 1-1
Site p. 1-2
Space p. 1-2
Specification p. 6-2
Storage p. 1-4
Supplies p. 1-3
Symbols p. ix

T

The Fuser Oil has run out p. 4-13
Toner Bottle p. 4-4
Toner Hopper pp. 2-4, 4-4
Toner Hopper Lid pp. 2-4, 4-5
Toner near empty p. 4-4
Transfer Film p. 4-8
Transfer/Fusing Unit p. 4-10
Troubleshooting p. 5-1
Turning ON and OFF p. 2-6

U

Using the Unit Properly p. 1-3
Upper/Lower Tray pp. 2-3, 4-2

W

Width p. ix

5. About this Manual

Copyright © 1999 Minolta Co., Ltd.

All Rights Reserved.

Reproduction, adaptation, or translation without prior written permission is prohibited, except as allowed under the copyright laws.

Document number 4119-77xx-01B.

2nd Edition.

Trademark Credits

CF911PE and Minolta are trademarks or registered trademarks of Minolta Co., Ltd.

Cluster Printing, PrintLink, PrintStation and MicroSpool are trademarks of TR Systems, Incorporated.

All other brand or product names used in this document are trademarks or registered trademarks of their respective holders.



***Copyright 1999 MINOLTA CO., LTD.
Made in Japan***

The information contained in this manual is
subject to change without notice to
incorporate improvements made on the
product or products the manual covers.

MINOLTA CO., LTD.

Image Information Products Marketing Headquarters

3-13, 2-Chome, Azuchi-Machi, Chuo-ku, Osaka 541-8556, Japan