

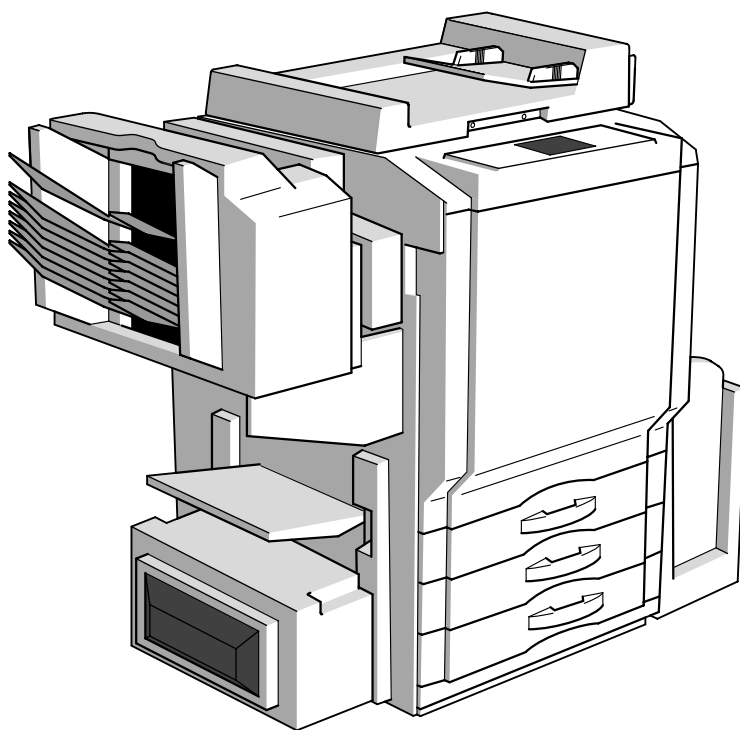

CF9001

Operator's Manual



SAFETY INFORMATION



This section contains detailed instructions on the operation and maintenance of this machine. To achieve optimum utility of this device, all operators should carefully read and follow the instructions in this manual. Please keep this manual in a handy place near the machine.

Please read the next section before using this device. It contains important information related to user safety and preventing equipment problems.

Make sure you observe all of the precautions listed in this manual.

*Please note that some parts of the contents of this section may not correspond with the purchased product.

■ Warning and Precaution Symbols

 WARNING:	Ignoring this warning could cause serious injury or even death.
 CAUTION:	Ignoring this caution could cause injury or damage to property.

■ Meaning of Symbols



A triangle indicates a danger against which you should take precaution.



This symbol warns against possible electrical shock.



A diagonal line indicates a prohibited course of action.



This symbol warns against dismantling the device.



A black circle indicates an imperative course of action.



This symbol indicates you must unplug the device.



WARNING



- Do not modify this product, as a fire, electrical shock, or breakdown could result. If the product employs a laser, the laser beam source could cause blindness.
- Do not attempt to remove the covers and panels which have been fixed to the product. Some products have a high-voltage part or a laser beam source inside that could cause an electrical shock or blindness.



- Only use the power cord supplied in the package. Failure to use this cord could result in a fire or electrical shock.
- Use only the specified power source voltage. Failure to do that could result in a fire or electrical shock.
- Do not use a multiple outlet adapter to connect any other appliances or machines. Use of a power outlet for more than the marked current value could result in a fire or electrical shock.



Do not unplug and plug in the power cord with a wet hand, as an electrical shock could result.



Plug the power cord all the way into the power outlet. Failure to do this could result in a fire or electrical shock.



- Do not scratch, abrade, place a heavy object on, heat, twist, bend, pull on, or damage the power cord. Use of a damaged power cord (exposed core wire, broken wire, etc.) could result in a fire or breakdown. Should any of these conditions be found, immediately turn OFF the power switch, unplug the power cord from the power outlet, and then call your authorized service representative.
- In principle, do not use an extension cord. Use of an extension cord could cause a fire or electrical shock. Contact your authorized service representative if an extension cord is required.



WARNING



Do not place a flower vase or other container that contains water, or metal clips or other small metallic objects on this product. Spilled water or metallic objects dropped inside the product could result in a fire, electrical shock, or breakdown. Should a piece of metal, water, or any other similar foreign matter get inside the product, immediately turn OFF the power switch, unplug the power cord from the power outlet, and then call your authorized service representative.



- If this product becomes inordinately hot or emits smoke, or unusual odor or noise, immediately turn OFF the power switch, unplug the power cord from the power outlet, and then call your authorized service representative. If you keep on using it as is, a fire or electrical shock could result.
- If this product has been dropped or its cover damaged, immediately turn OFF the power switch, unplug the power cord from the power outlet, and then call your authorized service representative. If you keep on using it as is, a fire or electrical shock could result.



Do not throw the toner cartridge or toner into an open flame. The hot toner may scatter and cause burns or other damage.



Connect the power cord to an electrical outlet that is equipped with a grounding terminal.



CAUTION



- Do not use flammable sprays, liquids, or gases near this product, as a fire could result.
- Do not leave a toner unit or drum unit in a place within easy reach of children. Licking or ingesting any of these things could injure your health.
- Do not let any object plug the ventilation holes of this product. Heat could accumulate inside the product, resulting in a fire or malfunction.
- Do not install this product at a site that is exposed to direct sunlight, or near an air conditioner or heating apparatus. The resultant temperature changes inside the product could cause a malfunction, fire, or electrical shock.
- Do not place the product in a dusty place, or a site exposed to soot or steam, near a kitchen table, bath, or a humidifier. A fire, electrical shock, or breakdown could result.
- Do not place this product on an unstable or tilted bench, or in a location subject to a lot of vibration and shock. It could drop or fall, causing personal injury or mechanical breakdown.
- After installing this product, mount it on a secure base. If the unit moves or falls, it may cause personal injury.
- Do not store toner units and PC drum units near a floppy disk or watch that are susceptible to magnetism. They could cause these products to malfunction.



The inside of this product has areas subject to high temperature, which may cause burns. When checking the inside of the unit for malfunctions such as a paper misfeed, do not touch the locations (around the fusing unit, etc.) which are indicated by a “Caution ! High Temperature !” warning label.



Do not place any objects around the power plug as the power plug may be difficult to pull out when an emergency occurs.



- Always use this product in a well ventilated location. Operating the product in a poorly ventilated room for an extended period of time could injure your health. Ventilate the room at regular intervals.
- Whenever moving this product, be sure to disconnect the power cord and other cables. Failure to do this could damage the cord or cable, resulting in a fire, electrical shock, or breakdown.
- When moving this product, always hold it by the locations specified in the operator’s manual or other documents. If the unit falls it may cause severe personal injury. The product may also be damaged or malfunction.
- Remove the power plug from the outlet more than one time a year and clean the area between the plug terminals. Dust that accumulates between the plug terminals may cause a fire.
- When unplugging the power cord, be sure to hold onto the plug. Pulling on the power cord could damage the cord, resulting in a fire or electrical shock.

Precautions for Routine Use



- Do not store toner units, PC drum units, and other supplies and consumables in a place subject to direct sunlight and high temperature and humidity, as poor image quality and malfunction could result.
- Do not attempt to replace the toner unit and PC drum unit in a place exposed to direct sunlight. If the PC drum is exposed to intense light, poor image quality could result.
- Do not unpack a toner unit or PC drum unit until the very time of use. Do not leave an unpacked unit standing. Install it immediately or poor image quality could result.
- Do not keep toner units and PC drum units in an upright position or upside down, as poor image quality could result.
- Do not throw or drop a toner unit or PC drum unit as poor image quality could result.
- Do not use this product in an area where ammonia or other gases or chemicals are present. Failure to do so may shorten the service life of the product, cause damage or decrease performance.
- Do not use this product in an environment with a temperature outside the range specified in the operator's manual, as a breakdown or malfunction could result.
- Do not attempt to feed stapled paper, carbon paper or aluminum foil through this product, as a malfunction or fire could result.



Do not touch or scratch the surface of the toner unit, developing roller and the PC drum, as poor image quality could result.



Use the supplies and consumables recommended by the dealer. Use of any supply or consumable not recommended could result in poor image quality and breakdown.

CF9001

Thank you for choosing Minolta.

This operator's manual explains how to operate the color copier and replenish its supplies. It also gives some troubleshooting tips as well as general precautions to be observed when operating the color copier.

To ensure the best performance and effective use of your color copier, read this manual carefully until you familiarize yourself thoroughly with its operation and features. After you have read through the manual, keep it for ready reference.

Please use this manual as a quick and handy reference tool for immediately clarifying any questions which may arise.

Contents

Organization

Chapters 1 through 3 contain the basic information for making copies.
Be sure to read these chapters before attempting to use your copier.

Chapter 1

Safety Notes

1. Installing the Copier
 - Installation Site 1-1
 - Power Source 1-1
 - Space Requirements 1-1
2. Precautions for Use
 - Operating Environment 1-2
 - Using the Copier Properly 1-2
 - Moving 1-2
 - Care of Copier Supplies 1-2
 - Storage of Copies 1-3
 - Legal Restrictions on Copying 1-3

Chapter 2

Getting to Know Your Copier

1. System Overview
 - System Overview 2-1
2. Copier Parts and Accessories
 - Outside the Copier 2-2
 - Options 2-3
 - Inside the Copier 2-4
3. Control Panel Keys and Touch Panel
 - Control Panel Keys and Touch Panel 2-5
4. Touch Panel
 - What is the Touch Panel? 2-7
 - How the Screen is Organized 2-7
 - Operating the Touch Panel 2-8
5. Turning ON and OFF and Initial Mode
 - Turning ON and OFF 2-9
 - When Copier is Turned ON 2-9
 - Initial Mode 2-9
 - Note on making multiple copies 2-9
6. Auxiliary Functions
 - Auxiliary Functions 2-10

Chapter 3

Making Copies

1. Basic Copying Overview
 - Basic Copying Overview 3-1
2. Placing Originals
 - Placing Originals on the Glass 3-3
 - Using the Duplexing Document Feeder 3-5
3. Basic Functions
 - Copy Paper Size 3-9
 - Manual Bypass Copying 3-11
 - Zoom Ratio 3-13
 - Image Density 3-17

Adjusting the background level.....	3-17
Adjusting the Image Density.....	3-18
4. Input ► Output Mode	
Original ► Copy Types.....	3-19
Selecting Input ► Output Mode.....	3-21
Input the number of originals.....	3-22
Mixed Original Detection Mode.....	3-23
Instructions for Loading Originals.....	3-24
Finishing Modes.....	3-25
5. Color Adjust Mode (Basic)	
Basic Adjustment Items.....	3-30
Color Adjust Procedure (Basic).....	3-31
Selecting the Original Image Type.....	3-32
6. Photo Mode	
Making Copies from a Photo.....	3-33
Setting Mirror Image in Photo Mode.....	3-36
Storing the Photo Size in Memory.....	3-37

Chapter 4

Professional Way to Make Color Copies

1. Using the Applied Input ► Output Functions	
Frame Erase.....	4-1
File Margin.....	4-3
OHP Interleaving.....	4-6
Cover Sheet.....	4-9
2. Color Adjust Mode (Professional)	
Professional Adjustment Items.....	4-11
Color Adjust Procedure (Professional: Other Than Color Balance).....	4-12
Color Adjust Procedure (Color Balance).....	4-13
3. Using the Digital Art Functions	
Digital Art Functions List.....	4-15
Monotone.....	4-17
Background Color.....	4-18
Neg.-Pos. Reverse.....	4-19
Color Separation.....	4-20
X/Y Zoom.....	4-21
Image Repeat.....	4-23
Multi-Page Enlargement.....	4-25
Mirror Image.....	4-29
Postcard.....	4-31

Chapter 5





Setting the Utility Mode

1. Default Settings	
Default Settings Changing Procedure.....	5-1
2. Meter Count	
Calling up Meter Count.....	5-2
Glossary of Touch Panel Terms:.....	5-2
Printing the Meter Count Data.....	5-2
3. Copy Track Functions	
Setting the Copy Track Functions.....	5-3
Changing the Account Number.....	5-4

Programming the Access Numbers.....	5-5
Checking the Number of Copies Made by Each Account	5-6
Resetting Counters	5-7
Prohibiting Color Copying for Each Account.....	5-8
Setting the Maximum Number of Copies to be Made by Each Account.....	5-9
4. Gradation Adjust	
Gradation Adjust Sequence.....	5-11
5. Dummy Rotation	
Changing Dummy Rotation Setting	5-13
6. Gamma-Curve Limitation	
Gamma-Curve Limitation Setting.....	5-14
7. Thick 2 Duplex	
Thick 2 Duplex Setting	5-15
Making 2-Sided Copies on Thick 2	5-16
8. Storing and Calling Jobs	
Job Memory Input Procedure.....	5-17
Calling up a Job.....	5-18
9. User's Choice	
User's Choice Functions	5-19
User's Choice Setting Changing Procedure.....	5-20
10. Image Centering	
Turning ON or OFF Image Centering.....	5-21
11. Scanner Address Input	
Scanner Address Input	5-22

Chapter 6

When a Message Appears

1. When the Message "Load paper in the XXXX Tray." Appears	
Paper Loading Procedures	6-1
2. When the Message "Please add Toner." Appears	
Replenishing Toner	6-3
3. When the Message "The Staple Cartridge is empty." Appears	
Replacing the Staple Cartridge	6-5
4. When the Message "Misfeeding is detected." Appears	
Misfeed Location Displays	6-7
Misfeed Clearing Procedures	6-8
5. When the Message "The Fuser Oil has run out." Appears	
Replenishing the Fuser Oil.....	6-14
6. When  or  Appears	
When  Appears.....	6-17
When  Appears.....	6-17
7. What Does Each Message Mean?	
What Does Each Message Mean?.....	6-18

Chapter 7

Troubleshooting

1. When This Type of Copy is Produced	
When This Type of Copy is Produced	7-1
2. The Copier is not functioning as designed	
The Copier is not functioning as designed.....	7-3

Chapter 8

Miscellaneous

1. Specifications	
Specifications	8-1
2. Care of the Copier	
Cleaning	8-7
3. Function Combination Matrix	
Function Combination Matrix	8-9
Precautions for Setting the Color Adjust Function	8-10
4. Description of Paper Size and Zoom Ratio Table	
Description of Paper Size and Zoom Ratio Table.....	8-11
5. Index	
Index.....	8-12

Terms and Symbols for the Type of Originals and Copy Paper

A few special terms and symbols are used in this manual to designate types of originals and copy paper. This page explains about these terms and symbols.

Feeding Direction (copy paper path)

In this copier system, copy paper is taken up from the left-hand side of the copier and fed through the copier toward the right-hand side, out face down onto the Exit Tray. In the figure below, the direction in which the copy paper is fed, as indicated by the arrow, is called the “feeding direction.”

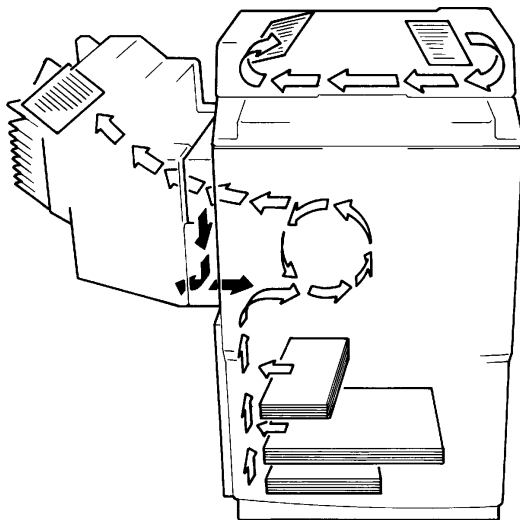

1154O001AA

“Width” and “Length”

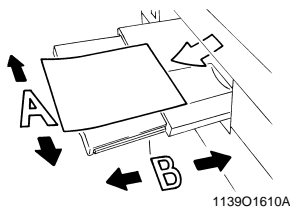

1139O1610A

When we talk about the size of the original or copy, we call side A “width” and side B “length.”

A: Width
B: Length

Terms and Symbols Used

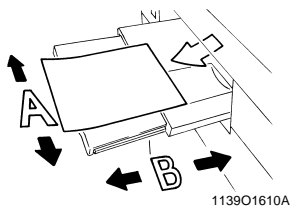

1139O1610A

<Lengthwise >

When the original or copy has a “length” longer than its “width,” we call it “lengthwise” and use symbol “L” or “.

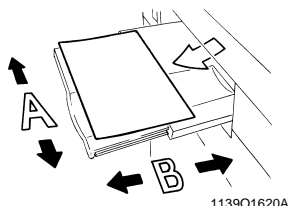

1139O1620A

<Crosswise >

When the original or copy has a “length” shorter than its “width,” we call it “crosswise” and use symbol “C” or “.

Safety Information

Thank you for choosing Minolta quality. For over 30 years Minolta has been a leader on the forefront of office equipment technology and service. Our desire has always been to bring you highly reliable products. We pledge to continue to provide you, our customer, with our state of the art equipment, as well as full customer service for all our products. We look forward to a long healthy relationship with you and our company. If you have any questions or comments about Minolta, our product or service, please let us know. Our fax number is 800-237-8087 (for the U.S.A. and Canada). Thank you again.

This operator's manual explains how to operate the copier and replenish its supplies. It also gives some troubleshooting tips as well as general precautions to be observed when operating the copier.

To ensure the best performance and effective use of your copier, read this manual carefully until you familiarize yourself thoroughly with the copier's operation and features. After you have read through the manual, keep it ready for reference.

Please use this manual as a quick and handy reference tool for immediately clarifying any questions which may arise.

MC-F01

WARNING

This equipment has been tested and found to comply with the limits for a Class A digital device, pursuant to Part 15 of the FCC Rules. These limits are designed to provide reasonable protection against harmful interference when the equipment is operated in a commercial environment. This equipment generates, uses, and can radiate radio frequency energy and if not installed and used in accordance with the instruction manual, may cause harmful interference to radio communications. Operation of this equipment in a residential area is likely to cause harmful interference in which case the user will be required to correct the interference at his own expense.

The design and production of this unit conforms to FCC Regulations, and any changes or modifications must be registered with the FCC and are subject to FCC control. Any changes made by the purchaser or user without first contacting the manufacturer will be subject to penalty under FCC regulations.

This device must be used with shielded interface (Parallel) cable and shielded network (10/100Base-T) cable.

The use of non-shielded cable is likely to result in interference with radio communications and is prohibited under FCC rules.

FCC-F01

This Class A digital apparatus complies with Canadian ICES-003.

Cet appareil numérique de la classe A est conforme à la norme NMB-003 du Canada.

IC-F03

Safety Information

Laser Safety

This is a digital machine which operates by means of a laser. There is no possibility of danger from the laser, provided the machine is operated according to the instructions in this manual.

Since radiation emitted by the laser is completely confined within protective housing, the laser beam cannot escape from the machine during any phase of user operation.

This machine is certified as a Class 1 laser product. This means the machine does not produce hazardous laser radiation.

Internal Laser Radiation

Maximum Average Radiat Power: 78.1 μ W at the laser aperture of the print head unit.

Wavelength: 675-695 nm

This product employs a Class IIb Laser Diode that emits an invisible laser beam.

The Laser Diode and the Scanning Polygon Mirror are Incorporated in the print head unit.

The print head unit is NOT A FIELD SERVICE ITEM.

Therefore, the print head unit should not be opened under any circumstances.

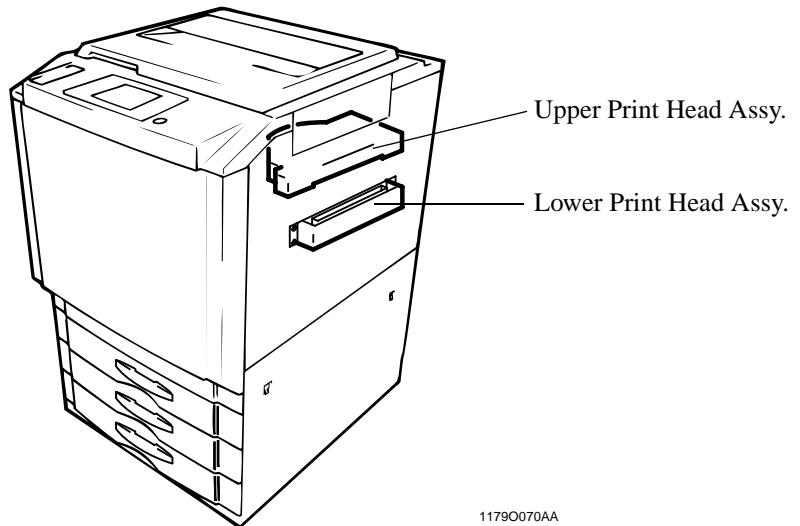

1179O070AA

CDRH Regulations

For the United States

This machine is certified as a Class I Laser product under Radiation Performance Standard according to the Food, Drug and Cosmetic Act of 1990. Compliance is mandatory for Laser products marketed in the United States and is reported to the Center for Devices and Radiological Health (CDRH) of the U.S. Food and Drug Administration of the U.S. Department of Health and Human Services (DHHS). This means that the device does not produce hazardous laser radiation.

The label shown to page x indicates compliance with the CDRH regulations and must be attached to laser products marketed in the United States.

CAUTION:

Use of controls, adjustments or performance of procedures other than those specified in this manual may result in hazardous radiation exposure.

This is a semiconductor laser. The maximum power of the laser diode is 35 mW and the wavelength is 675-695 nm.

For European Users

CAUTION:

Use of controls, adjustments or performance of procedures other than those specified in this manual may result in hazardous radiation exposure.

This is a semiconductor laser. The maximum power of the laser diode is 35 mW and the wavelength is 675-695 nm.

For Denmark Users

ADVARSEL

Usynlig laserstråling ved åbning, når sikkerhedsafbrydere er ude af funktion. Undgå udsættelse for stråling. Klasse 1 laser produkt der opfylder IEC60825 sikkerheds kravene.

Dansk: Dette er en halvlederlaser. Laserdiodens højeste styrke er 35 mW og bølgelængden er 675-695nm.

Safety Information

For Finland, Sweden Users

LOUKAN 1 LASERLAITE
KLASS 1 LASER APPARAT

VAROITUS!

Laitteen Käyttäminen muulla kuin tässä käyttöohjeessa mainitulla tavalla saattaa altistaa käyttäjän turvallisuusluokan 1 ylittävälle näkymättömälle lasersäteilylle.

Tämä on puolijohdelaser. Laserdiodin suurin teho on 35 mW ja aallonpituus on 675-695 nm.

WARNING!

Om apparaten används på annat sätt än i denna bruksanvisning specificerats, kan användaren utsättas för osynlig laserstrålning, som överskrider gränsen för laserklass 1.

Det här är en halvledarlasert. Den maximala effekten för laserdioden är 35 mW och våglängden är 675-695 nm.

VARO!

Avattaessa ja suojalukitus ohitettaessa olet alttiina näkymättömälle lasersäteilylle. Älä katso säteeseen.

WARNING!

Osynlig laserstrålning när denna del är öppnad och spärren är urkopplad. Betrakta ej strålen.

For Norway Users

ADVERSEL

Dersom apparatet brukes på annen måte enn spesifisert i denne bruksanvisning, kan brukeren utsettes for usynlig laserstrålning som overskrider grensen for laser klass 1.

Dette en halvleder laser. Maksimal effekt till laserdioder er 35 mW og bølgelengde er 675-695 nm.

Laser Safety Label

A laser safety label is attached to the outside of the machine shown below.

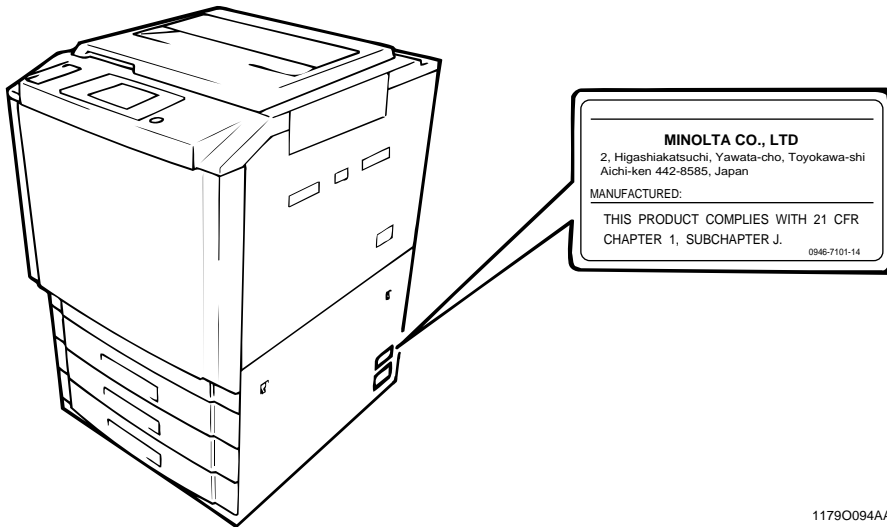

1179O094AA

Location of Laser Warning Labels Inside the Copier (Front)

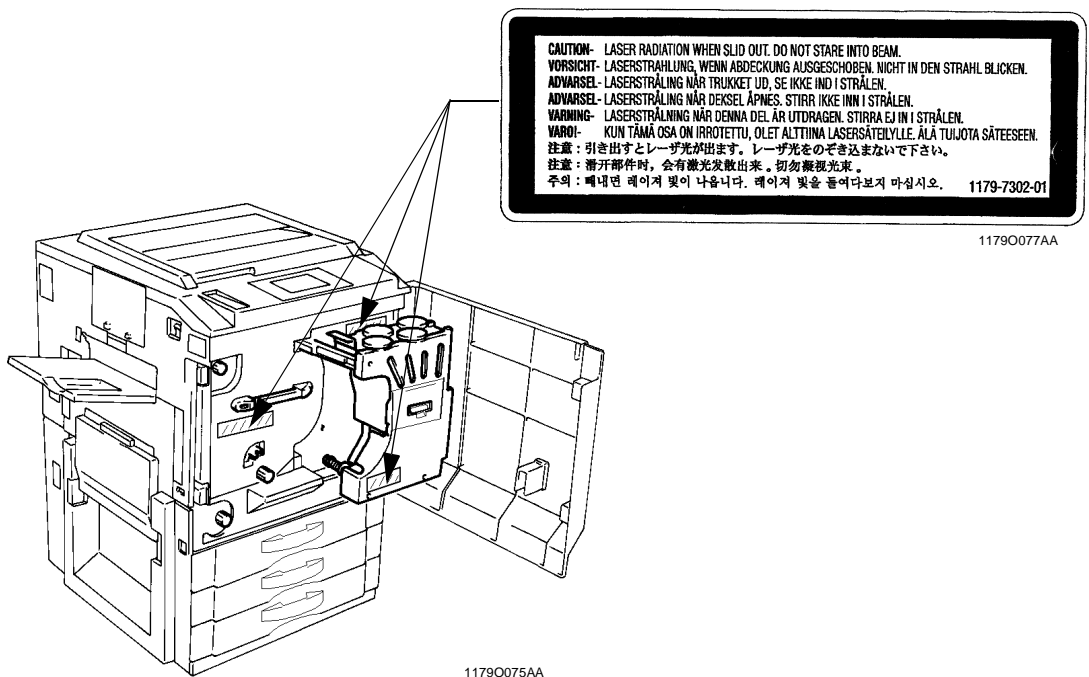

1179O077AA

1179O075AA

Internal Right Side View

注意: ここを開くとレーザー光が出ます。ビームを直接見たり、触れたりしないで下さい。
DANGER- Laser radiation when open. AVOID DIRECT EXPOSURE TO BEAM.
CAUTION- LASER RADIATION WHEN OPEN. AVOID EXPOSURE TO BEAM.
VORSICHT- LASERSTRAHLUNG, WENN ABDECKUNG GEÖFFNET. NICHT DEM STRAHL AUSSETZEN.
ADVARSEL- LASERSTRÅLING NÅR DEKSEL ÅPNES. UNNGÅ EKSPONERING FOR STRÅLEN.
VARO! AVATTAESSA OLET ALTIINNA LASERSÄTEILYLLE. ÄLÄ KATSO SÄTEESEEN.
ADVARSEL- LASERSTRÅLING VED ÅBNING. UNDGÅ UDSÆTTELSE FOR STRÅLING.
WARNING- LASERSTRÅLING NÅR DENNA DEL ÄR ÖPPNAD. STRÅLEN ÄR FARLIG.
 注意: 当蓋打开这里时, 会出现激光射线, 请不要直视或接触光线。 1179-7304-01

DANGER 
 Laser radiation when open.
AVOID DIRECT EXPOSURE TO BEAM
 1179-7305-01

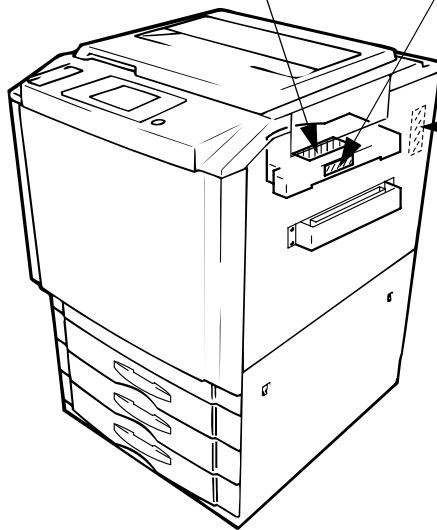

注意: ここを開くとレーザー光が出ます。レーザー光をのぞき込まないで下さい。
CAUTION- LASER RADIATION WHEN OPEN. DO NOT STARE INTO BEAM.
ADVARSEL- LASERSTRÅLING, WENN ABDECKUNG GEÖFFNET. NICHT IN DEN STRAHL BLICKEN.
VARO! AVATTAESSA OLET ALTIINNA LASERSÄTEILYLLE. ÄLÄ TUUJOTA SÄTEESEEN.
WARNING- LASERSTRÅLING NÅR DENNA DEL ÄR ÖPPNAD. STIRRA EJ IN I STRÅLEN.
 注意: 当蓋打开这里时, 会有激光发射出来, 切勿直视激光。 1179-7306-02

Rear Side View

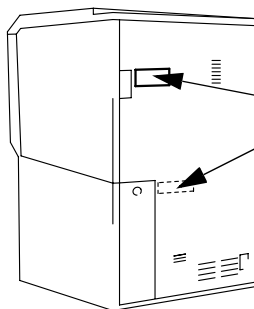

注意: ここを開くとレーザー光が出ます。レーザー光をのぞき込まないで下さい。
CAUTION- LASER RADIATION WHEN OPEN. DO NOT STARE INTO BEAM.
VORSICHT- LASERSTRAHLUNG, WENN ABDECKUNG GEÖFFNET. NICHT IN DEN STRAHL BLICKEN.
ADVARSEL- LASERSTRÅLING VED ÅBNING. SE IKKE INN I STRÅLEN.
ADVARSEL- LASERSTRÅLING NÅR DENNA DEL ÄR ÖPPNAD. STIRRA EJ IN I STRÅLEN.
VARO! AVATTAESSA OLET ALTIINNA LASERSÄTEILYLLE. ÄLÄ TUUJOTA SÄTEESEEN.
 注意: 当蓋打开这里时, 会有激光发射出来, 切勿直视激光。 1179-7303-02

1179O069AB

1179O078AA

1179O076AA

1179O078AA

1179O079AA

1179O080AA

Ozone Release

NOTE

= Locate the Machine in a Well Ventilated Room =

A negligible amount of ozone is generated during normal operation of this machine. An unpleasant odor may, however, be created in poorly ventilated rooms during extensive machine operations. For a comfortable, healthy, and safe operating environment, it is recommended that the room well ventilated.

REMARQUE

= Placer l'appareil dans une pièce largement ventilée =

Une quantité d'ozone négligable est dégagée pendant le fonctionnement de l'appareil quand celui-ci est utilisé normalement. Cependant, une odeur désagréable peut être ressentie dans les pièces dont l'aération est insuffisante et lorsque une utilisation prolongée de l'appareil est effectuée. Pour avoir la certitude de travailler dans un environnement réunissant des conditions de confort, santé et de sécurité, il est préférable de bien aérer la pièce où se trouve l'appareil.

Chapter 1

Safety Notes

1. Installing the Copier

Installation Site

To ensure utmost safety and prevent possible malfunctions of the copier, install it in a location which meets the following requirements.

- ◆ A place away from a curtain or the like that may catch fire and burn easily.
- ◆ An area where there is no possibility of being splashed with water or other types of liquid.
- ◆ An area free from direct sunlight.
- ◆ A place out of the direct air stream of an air conditioner, heater, or ventilator.
- ◆ A well-ventilated place.
- ◆ A dry place.
- ◆ A dust-free location.
- ◆ An area not subject to undue vibration.
- ◆ A stable and level location.
- ◆ A place where ammonia or other organic gas is not generated.
- ◆ A place which does not put the operator in the direct stream of exhaust from the copier.
- ◆ A place which is not near any kind of heating device.

Power Source

The power source voltage requirements are as follows.

- ◆ Use a power source with little voltage fluctuation.

Voltage Fluctuation	:	Within $\pm 10\%$
Frequency Fluctuation	:	Within $\pm 0.3\%$

Space Requirements

To ensure easy copier operation, supply replacements and service maintenance, adhere to the recommended space requirements detailed below.

- * Be sure to allow a clearance of 6 inch or more at the back of the copier as there is a ventilation duct.

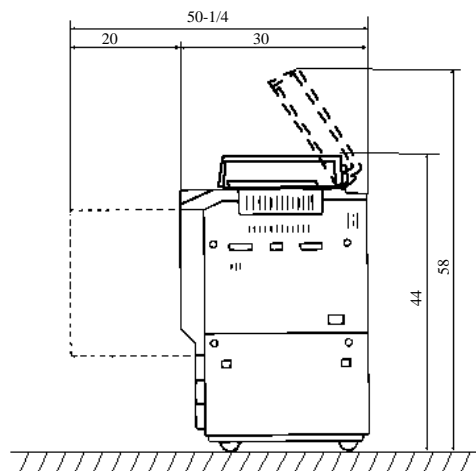
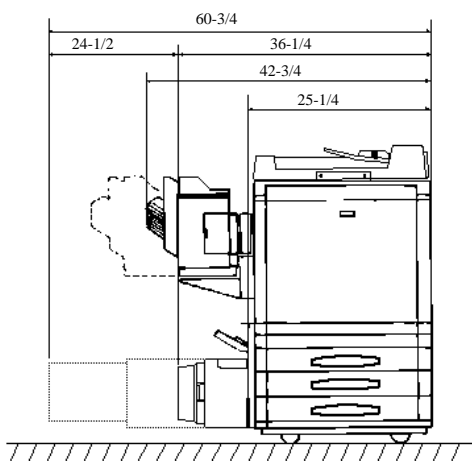

11790047AA

Scale: inch

2. Precautions for Use

Operating Environment

The operating environmental requirements of the copier are as follows.

Temperature	: 10°C to 30°C (50°F to 86°F) with a fluctuation of 10°C (18°F) per hour.
Humidity	: 25% to 85% with a fluctuation of 20% per hour.

Using the Copier Properly

To ensure the optimum performance of the copier, follow the precautions listed below.

- ◆ NEVER place a heavy object on the copier or subject the copier to shocks.
- ◆ NEVER open any Doors, or turn OFF the copier while the copier is making copies.
- ◆ NEVER bring any magnetized object or use flammable sprays near the copier.
- ◆ NEVER remodel the copier as a fire or electrical shock could result.
- ◆ ALWAYS insert the Power Plug all the way into the outlet.
- ◆ ALWAYS make sure that the outlet is visible, clear of the copier or copier cabinet.
- ◆ ALWAYS provide good ventilation when making a large number of continuous copies.

NOTE

= *Locate the Copier in a Well Ventilated Room* =

A negligible amount of ozone is generated during normal operation of this copier. An unpleasant odor may, however, be created in poorly ventilated rooms during extensive copier operations. For a comfortable, healthy, and safe operating environment, it is recommended that the room be well ventilated.

REMARQUE

= *Placer le copieur dans une pièce largement ventilée* =

Une quantité d'ozone négligeable est dégagée pendant le fonctionnement du copieur quand celui-ci est utilisé normalement. Cependant, une odeur désagréable peut être ressentie dans les pièces dont l'aération est insuffisante et lorsque une utilisation prolongée du copieur est effectuée. Pour avoir la certitude de travailler dans un environnement réunissant des conditions de confort, santé et de sécurité, il est préférable de bien aérer la pièce où se trouve le copieur.

Moving

If you need to transport the copier over a long distance, consult your Technical Representative.

Care of Copier Supplies

Use the following precautions when handling the copier supplies (toner, paper, etc.).

- ◆ Store the paper, toner, and other supplies in a place free from direct sunlight and away from any heating apparatus. Keep them in a dry, clean environment.
- ◆ Store paper, which has been removed from its wrapper but not loaded into the Drawer, in a sealed plastic bag in a cool, dark place.
- ◆ Keep supplies out of the reach of children.
- ◆ If your hands become soiled with toner, wash them with soap and water immediately.

Storage of Copies

- If copies are to be kept for a long time, keep them in a place which is not exposed to light to prevent fading.
- If an adhesive containing solvent (e.g., spray glue) is used to paste copies, the toner on the copies can melt.
- The color copies have a toner layer thicker than the normal black-and-white copies. When a color copy is folded, therefore, the toner at the fold can be separated.

NOTE

This copier is equipped with a counterfeit preventive function that can cause slight noise on the copy image.

Useful Tip

By activating the “Copy Track Functions” offered by this copier, nobody can use the copier unless he or she enters an access number that’s unique to his/her account.

It helps prevent dishonest use of the copier.

Legal Restrictions on Copying

Certain types of documents must never be copied by the copier for the purpose or with the intent to pass copies of such documents off as the original. The following is not a complete list but is meant to be used as a guide to responsible copying.

Financial Instruments

- Personal Checks
- Travelers Checks
- Money Orders
- Certificates of Deposit
- Bonds or other Certificates of Indebtedness
- Stock Certificates

Legal Documents

- Food Stamps
- Postage Stamps (canceled or uncanceled)
- Checks or Drafts drawn by Government Agencies
- Internal Revenue Stamps (canceled or uncanceled)
- Passports
- Immigration Papers
- Motor Vehicle Licenses and Titles
- House and Property Titles and Deeds

General

- Identification Cards, Badges, or Insignias
- Copyrighted Works without permission of the copyright owner

In addition, it is prohibited under any circumstances to copy domestic or foreign currencies or Works of Art without permission of the copyright owner.

When in doubt about the nature of a document, consult with legal counsel.

Chapter 2

Getting to Know Your Copier

1. System Overview

System Overview

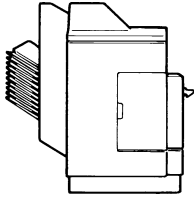

1139O0020A

Sorter S-105/Staple Sorter ST-103 <Option>

Permits automatic sorting or grouping of copies into 10 copy sets or stacks. In addition, the Staple Sorter automatically staples the copy sets or stacks that are sorted or grouped.



1151O007AA

Duplexing Document Feeder AFR-12 <Option>

In addition to being capable of feeding in sheet originals one at a time, it can automatically turn over the original for the making of copies from 2-sided originals.

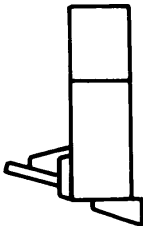

1144O184AA

Duplex Unit AD-7 <Option>

Automatically turns over 1-sided copies to make 2-sided copies.

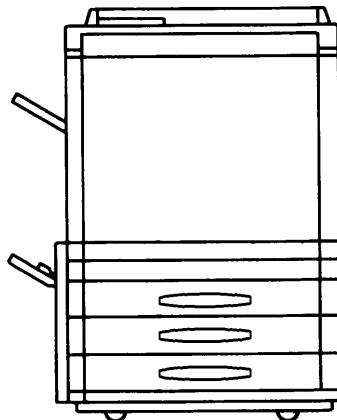

1179O014AA

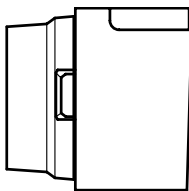

1154O028AA

Large Capacity Cassette C-101<Option>

Holds up to 1,100 sheets of LetterC copy paper (20 lb).

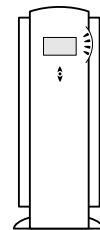

1179O046AA

Printer Controller Fiery X3e/ Fiery Z4 <Option>

Allows the Copier to be used as a color printer and color scanner configured in a computer network. For details, see the operator's manual for Fiery™ provided separately. Fiery is the trademark of Electronics for Imaging, Inc.

2. Copier Parts and Accessories

Outside the Copier

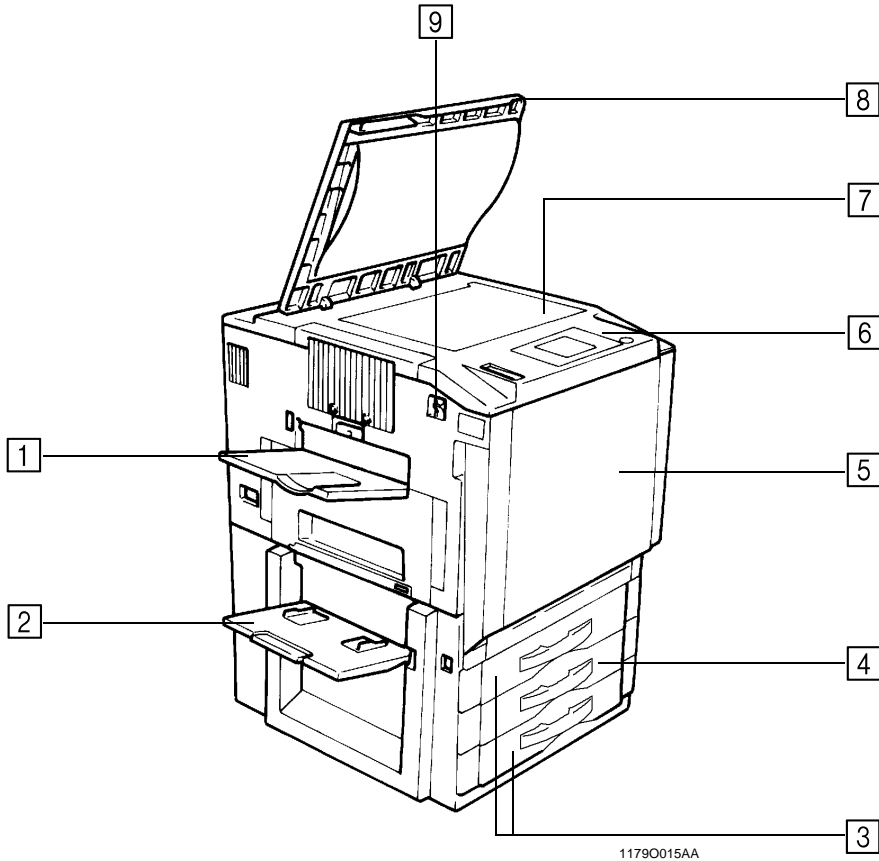

- | | | |
|----------|---------------------------------|--|
| 1 | Exit Tray: | Holds copies fed out of the copier. |
| 2 | Manual Bypass Tray: | Use for manual feeding of copy paper into the copier. ☞ p.3-11 |
| 3 | Upper/Lower Tray: | Holds up to 500 sheets of paper. ☞ p.6-1 |
| 4 | Middle Tray (Universal): | Holds up to 250 sheets of paper. ☞ p.6-1 |
| 5 | Front Door: | Open to clear a paper misfeed or add toner. ☞ pp.6-3, 6-9 |
| 6 | Control Panel: | Use to start a copy cycle or to make copy job settings.
(See) Control Panel Keys and Touch Panel. ☞ p.2-5 |
| 7 | Original Glass: | Place your original face down on this Glass. ☞ p.3-3 |
| 8 | Original Cover: | Holds the original in position. |
| 9 | Power Switch: | Use to turn the copier ON and OFF. ☞ p.2-9 |

Options

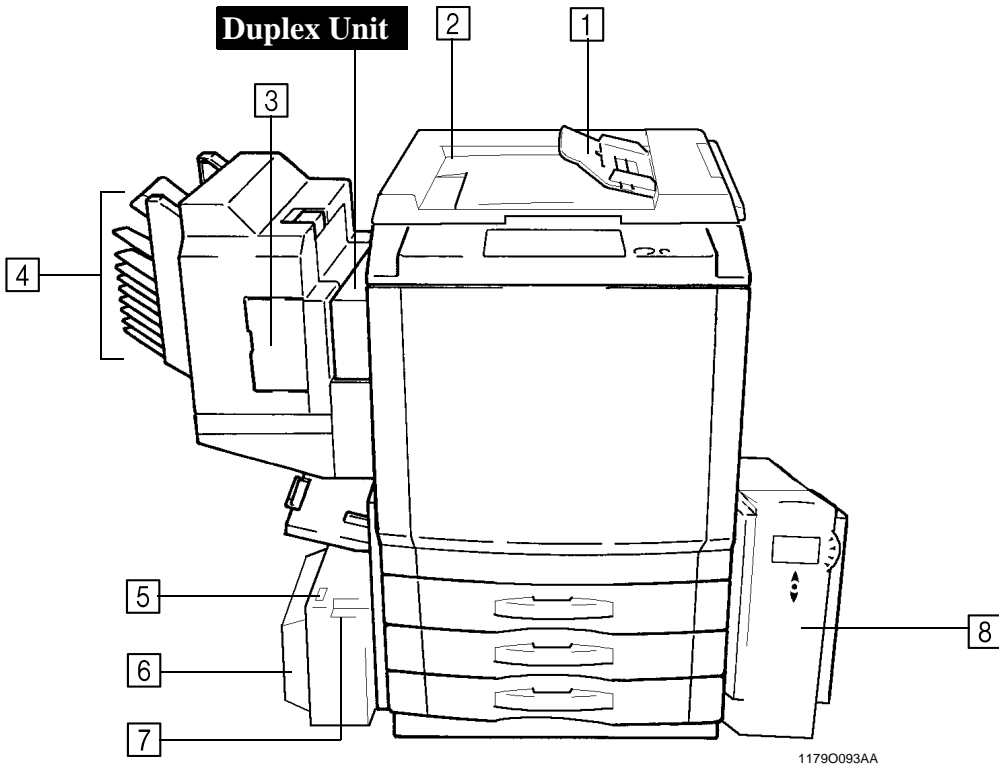

Duplexing Document Feeder

- 1 Document Feed Tray:** Load the originals face up on this tray. ☞ p.3-6
- 2 Document Exit Tray:** Receives originals automatically ejected from the Duplexing Document Feeder.

Sorter / Staple Sorter

- 3 Stapler Door:** Open to replace the Staple Cartridge. ☞ p.6-5
- 4 Sort Bins:** Hold sorted or grouped copies, each capable of holding up to 25.

Large Capacity Cassette

- 5 Paper Plate Descent Key:** Press to lower the Paper Plate.
- 6 Cassette Door:** Open to add paper or clear a misfed sheet of paper.
- 7 Cassette Release Lever:** Use to release the Cassette from the copier for clearing a misfed sheet of paper or other service job.

Printer Controller (Fiery)

- 8** For details, see the Operator's Manual for Printer Controller.

Inside the Copier

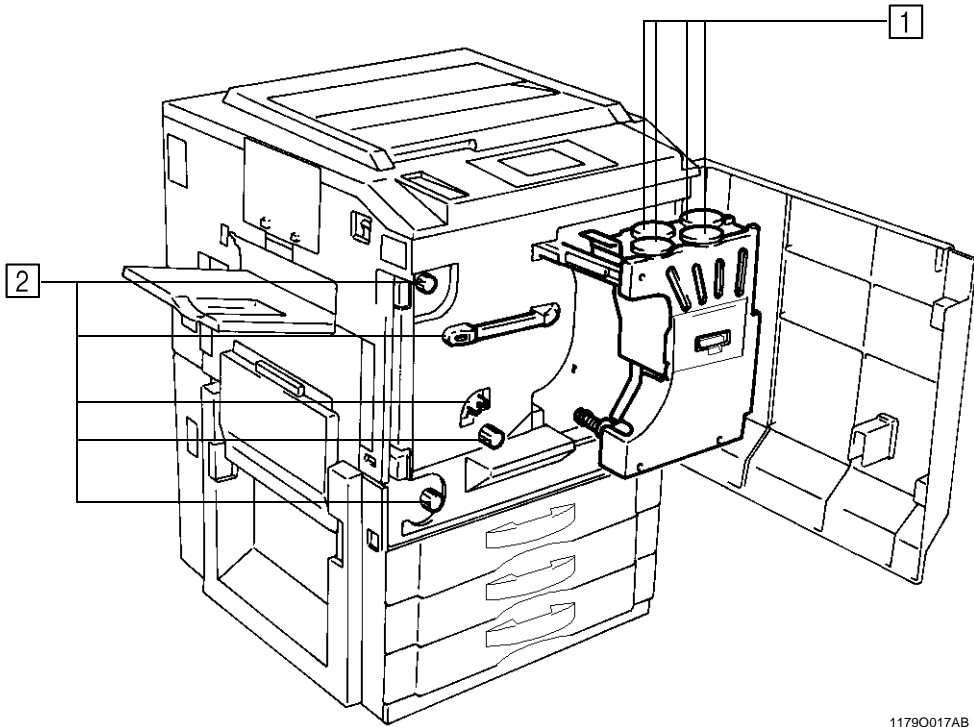

1179O017AB

1 Toner Hopper Lid:

Open when adding toner. ☞ p.6-3

2 M1 ~ M9:

Operate these parts to clear misfed sheets of paper. ☞ p.6-7

3. Control Panel Keys and Touch Panel

Control Panel Keys and Touch Panel

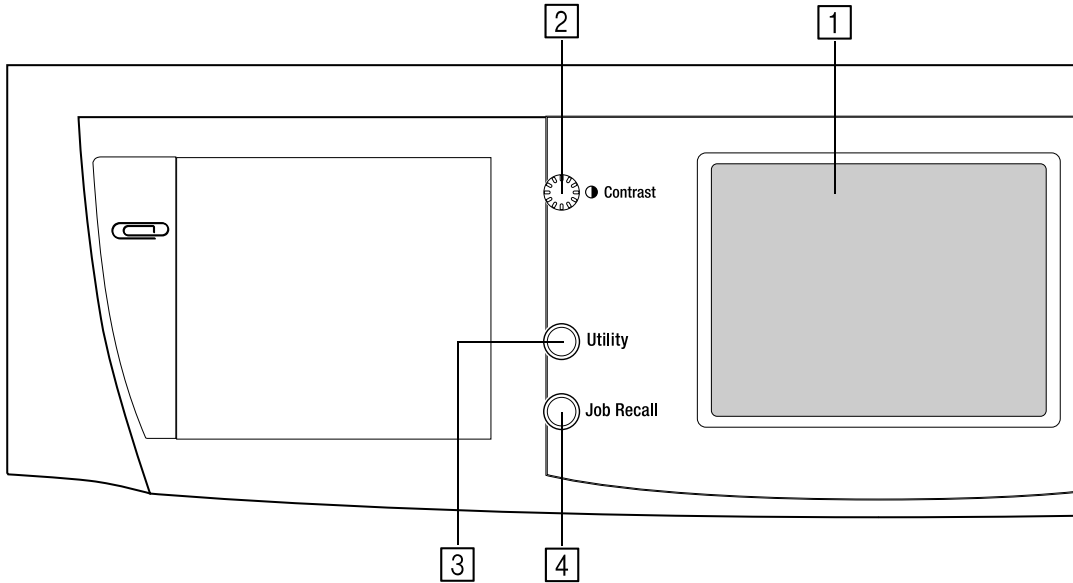

1 Touch Panel

- Shows various screens and messages.
(See) Touch Panel ☞ p.2-7

2 Display Contrast Control Knob

- Use to adjust the brightness of the Touch Panel.

3 Utility Key

- Press to select the Utility Mode setting screen.

Functions in Utility Mode

- | | |
|-------------------------|--------------------|
| • Default Settings | • Job Memory Input |
| • Meter Count | • User's Choice |
| • Admin. Mode | • Image Centering |
| • Scanner Address Input | |

(See) Setting the Utility Mode ☞ p.5-1

4 Job Recall Key

- Press to select the Job Recall screen, on which you can recall or check a copy job program previously stored in memory.
(See) Calling Up a Job ☞ p.5-18

5 Auto Color/Full Color/Black Keys

- When Auto Color is selected, the copier automatically checks and determines whether the original is in color or black-and-white and makes a full-color or black-and-white copy according to the original.
- When Full Color is selected, the copier makes a full-color copy even if the original is in black-and-white.
- When Black is selected, the copier makes a black-and-white copy even if the original is in color.

6 Start Key

- Press to start a copy cycle. ☞ p.3-2
- If pressed while the copier is warming up, it enables the Auto Copy Start Function.
☞ p.2-10

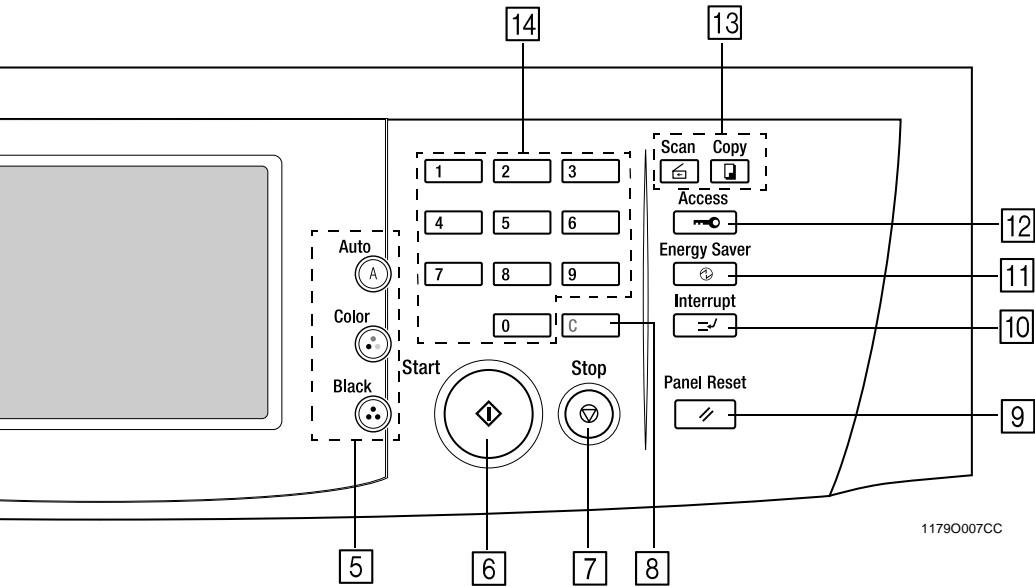
**7 Stop Key**

- Press to stop a multi-copy cycle. ☞ p.3-2

8 Clear Key

Press to:

- Reset the multi-copy entry to 1. ☞ p.3-2
- Clear a zoom ratio entered when setting one using the 10-Key Pad.

9 Panel Reset Key

- Press to set the copier into the initial mode, clearing all settings made previously on the control panel. ☞ p.2-10

NOTE

It does not, however, clear the settings made immediately before the Interrupt mode.

10 Interrupt Key

- Press to interrupt a current job with a different one. Press it again to return to the previous job. ☞ p.2-10

11 Energy Saver Key

- Press to set the copier into the Energy Saver Mode. ☞ p.2-10

12 Access Mode Key

- When the copy cycle is completed, press this key to go to the “Access # Prompt Screen.”

NOTE

*For details see 6. Auxiliary Functions.
☞ p.2-11*

13 Copy Key/Scan Key

- Press to select the Scanner mode or Copy mode. The Scanner mode can be used when the optional Printer Controller is mounted.

14 10-Key Pad

Use to:

- Enter the number of copies to be made.
- Enter the zoom ratio to be used.
- Enter the number of originals.

4. Touch Panel

What is the Touch Panel?

When you turn ON the Power Switch, the Basic screen as shown below appears on the Touch Panel. It shows in messages and graphics the currently set functions, available functions to choose from, and the copier status.

*Some of the Touch Panel screens used in the Operator's Manual may be different from what you actually will see on your copier.

How the Screen is Organized

(1) Supplementary Function Keys
 Digital Art, Color Adjust, Input ▶ Output, and Basics keys are displayed. When any of these keys is touched, the corresponding supplementary function screen appears.
 •Touching Basics returns you to the Basic screen.

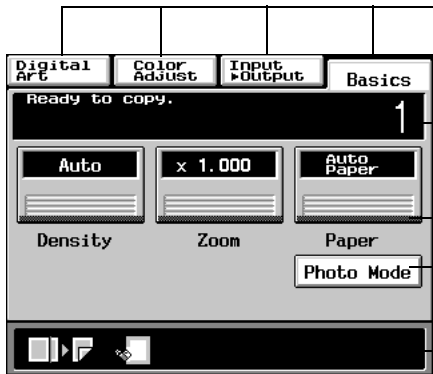

- (2) Message Display
- (3) Basic Function/Key Display
- (4) Press to set the copier into the Photo Mode.
- (5) Set Function Display

1179P165CA

(2) Message Display

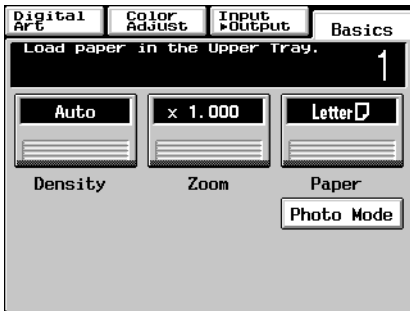

Shows the current copier status, operating instructions and precautions, and other data including the number of copies selected.

Example: Add paper

1179P169EA

(3) Basic Function/Key Display

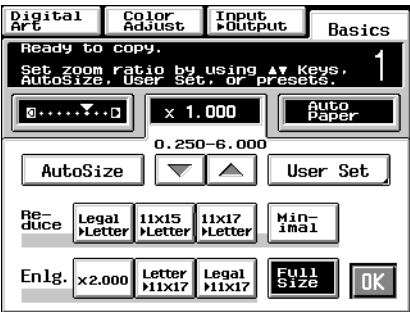

Shows the basic function keys and the corresponding functions currently selected for use. Touching a basic function key shows the corresponding basic function screen.

*What is shown inside the key is the current setting.

Example: Zoom

1179P170EA

(5) Set Function Display

Shows graphic representations of functions set other than the initial ones, including the

Input ▶ Output and **Digital Art** types.



1 ▶ 2



2 ▶ 1



2 ▶ 2



1 ▶ 2 in 1



1 ▶ 2 (2 in 1)



Book ▶ 1



Book ▶ 2



Sort



Group



Sort and Staple



Frame Erase



File Margin



Cover Sheet



OHP



Monotone

Background
ColorNeg. ↔ Pos.
ReverseColor Separation
(3-Color)Color Separation
(4-Color)

X/Y Zoom



Image Repeat

Multi-Page
Enlargement

Mirror Image

Operating the Touch Panel

You need only to lightly touch the key shown on the Touch Panel to select or activate the function represented by the key.

NOTE

NEVER press the Touch Panel hard or use a hard or pointed object to press it, as a damaged panel could result.

5. Turning ON and OFF and Initial Mode

Turning ON and OFF

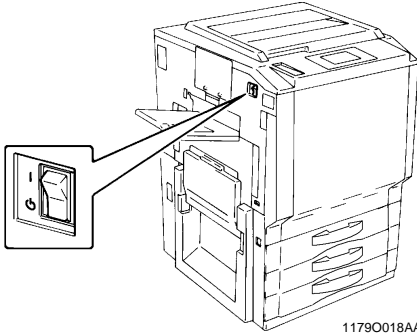

- Turning Copier ON
Press the Power Switch to the **I** (ON) position.
- Turning Copier OFF
Press the Power Switch to the **O** (OFF) position.

When Copier is Turned ON

When the Power Switch is turned ON, the message “Warming-up. Pre-program a job.” appears on the Touch Panel and the copier now enables its auto copy start function.

Auto Copy Start Function [p.2-10](#)

Pressing the Start Key at this point does not start a copy cycle. You’re going to have to wait for approx. 9 minutes (at an ambient temperature of 20°C/68°F).

Initial Mode

When the Power Switch is turned ON, the Basic screen appears on the Touch Panel. The settings on this screen are called the initial mode. The Basic screen serves as the reference for all panel settings to be later made.

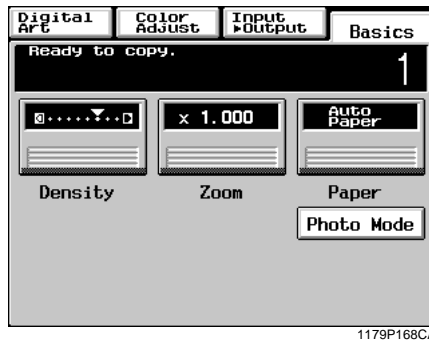

No. of copies selected	:1
Zoom	:× 1.000
Paper	:Auto Paper
Density	:Manual Expo.
Input ► Output	:1 ► 1
Finishing	:Non-Sort

Useful Tip

The initial mode can be changed. For details, see [Setting the Utility Mode. p.5-1](#)

Note on making multiple copies

If the fusing temperature drops excessively during a multi-copy cycle, there is a possibility that the copying speed will be reduced. The copying speed will automatically return to normal when the fusing temperature rises enough to ensure good fusing performance.

6. Auxiliary Functions

Auxiliary Functions

Panel Resetting

The Panel Reset Key resets all control panel settings to default settings including the number of copies and zoom ratio.

- * If the Duplexing Document Feeder is used, the original present on the Original Glass will be ejected out of the unit.

Useful Tips

- The Panel Reset Key enables you to cancel all previous settings efficiently.
- To avoid miscopy, try to press this Key before making any setting for your own copy job.
- Pressing this Key does not cancel the Interrupt Mode.

Auto Panel Reset Function

The Auto Panel Reset Function is automatically activated to return the copier to the default settings 5 min. after the copier has been touched last.

Useful Tip

The time for the copier to enter the Auto Panel Reset Function can be selected from 1 to 9 min. by using User's Choice. Also, the Auto Panel Reset function can be disabled by the User's Choice. ☞ p.5-19

Energy Saver Mode

If the copier is shut down when it is not in use, it takes the copier approx. 9 min. to complete the warm-up cycle. Instead of turning the copier OFF, it's a good idea to use the Energy Saver Mode. This mode will minimize the time for the copier to complete the warm-up cycle to about 60 sec.

- The Energy Saver Mode is automatically activated a given period of time after the copier has been touched last. The initial setting is 15 min.
- Pressing the Energy Saver Key sets the copier into the Energy Saver Mode.
- To cancel the Energy Saver Mode, press any key on the Control Panel, for instance, the Start Key.

Useful Tip

The time for the copier to enter the Energy Saver Mode can be selected from 1 to 240 min. by using User's Choice. ☞ p.5-19

Auto Copy Start Function

Even during the copier warm-up, the copier is set into the Auto Copy Start Function by loading the originals onto the Duplexing Document Feeder and pressing the Start Key.

This Function allows a copy process to be started as soon as the copier completes warming up (which takes approx. 9 min.).

Interrupt Mode

The Interrupt Mode allows you to interrupt a current job and run a different one. Pressing the Interrupt Key once sets the copier into the Interrupt Mode. Pressing the Key again cancels the Interrupt Mode and returns to the previous settings.

NOTES

- Pressing the Interrupt Key resets all settings to the initial ones.
For details, see "Default Settings." ☞ p.5-1
- Some functions set before the Interrupt Mode disable Interrupt copying. Further, when in the Interrupt Mode, the copier defies setting of some functions.
For more details, see "Function Combination Matrix." ☞ p.8-9
- To cancel an Interrupt cycle, you need to press the Interrupt key. The Panel Reset key or Auto Panel Reset function does not serve this purpose.

6. Auxiliary Functions

Access Number

If an access number has been programmed, it allows only particular persons to use the copier or a supervisor to keep track of the number of copies made by a particular department.

NOTES

- *If an access number has been programmed, a copy cycle can be initiated only after the access number has been input to the copier.*

<“Access #” Prompt Screen>



- *Before you can use this function, you must first turn “ON” the “Copy Track” function of the Administrator Mode available from User’s Choice. ☞ p.5-3*

Entering the Access Number

- 1 Using the 10-Key Pad, enter the 4-digit access number and press the OK Key.

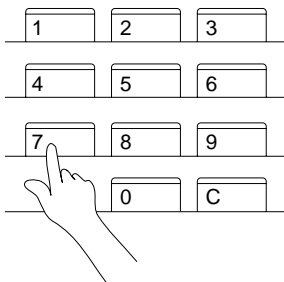

1154O401

NOTE

To correct the 4-digit access number entered, first press the Clear Key, then enter the new number.

- 2 The Touch Panel changes from the “Access #” prompt to the initial screen. A copy cycle can now be started. Make your copies as necessary.
- 3 When the copy cycle is completed, press the Access Mode Key to go to the “Access # Prompt Screen.”

Using the Copier as a Printer

When the optional Printer Controller (Fiery™) is hooked up to the copier*, the copier can be used as a full color printer for a computer.

For more details, see the Operator's Manual of the Printer Controller.

Transfer Drum Cleaning Function

To maintain optimum copy quality, this copier automatically enters the Transfer Drum Cleaning mode at the following timing.

Cleaning takes about 40 seconds.

Color Mode	Timing
Full Color	24 or 48* copies in multicopy mode.
Mono Color	
Black and White	48 or 96* copies in multicopy mode.

* Timing will differ based on selected paper size and other settings.

Chapter 3

Making Copies

1. Basic Copying Overview

Basic Copying Overview

- Place the original in position (step 1), set the number of copies to be made (step 9), and press the Start Key (step 10). This will allow you to make a full-size copy or copies on paper of the same size as the original.

NOTE

Automatically selected in the initial mode are Auto Paper, Full Size, and Manual Exposure.

- The selections  you make on the Touch Panel will change the exposure level, zoom ratio, the type of copy and so on.

1. Placing the Original  p.3-3

- Load the originals face up on the Duplexing Document Feeder.

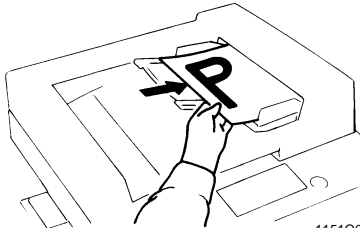

11510016AA

- Raise the Original Cover and place the original face down on the Glass.

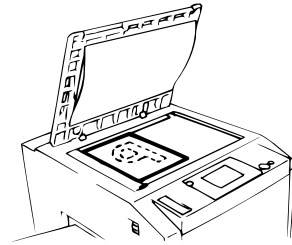

11790048AA

- To make a black-and-white copy from a colored original
- To make a colored copy from a black-and-white original



— Selecting the Color mode —

2. Press either Auto Color, Full Color, or Black.

Auto Color: The copier automatically determines whether the original is in color or black-and-white and makes a full-color or black-and-white copy according to the original.

Full Color: The copier makes a full-color copy regardless of the type of original.

Black: The copier makes a black-and-white copy regardless of the type of original.

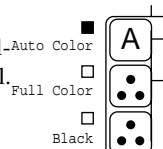

11440256CA

To change the copy paper size



— Selecting the basic functions —

3. Touch Paper.  p.3-9

To change the zoom ratio



4. Touch Zoom.  p.3-13

To change the exposure level



5. Touch Density.  p.3-17



1179P171CA

- To make 2-sided copies from 1-sided originals
- To sort copies
- To make a file margin on the copy



— Selecting the Input > Output —

6. Touch Input > Output.  p.3-19

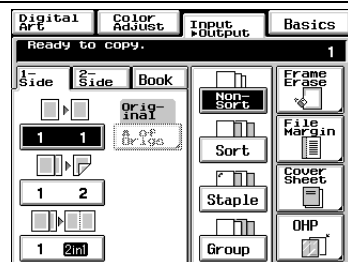

1179P172CA



- To adjust level of colors
- To make outline of image sharper or softer



Selecting the Color Adjust functions

7. Touch Color Adjust.

☞ p.3-30



1179P173CA

- To make monotone copy
- To make a very large copy (Multi-Page Enlargement Copy)



Selecting the Digital Art functions

8. Touch Digital Art.

☞ p.4-15

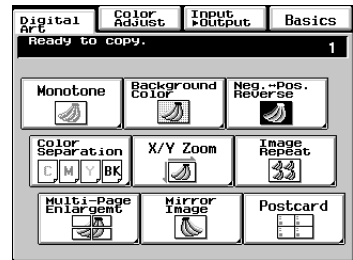

1179P174CA

9. Setting the number of copies.

- Using the 10-Key Pad, set the desired number of copies to be made.

NOTE

If you have entered an incorrect number, press the Clear Key, then enter the correct number.

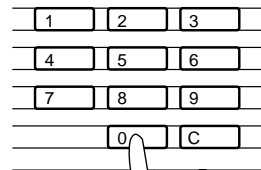

1139O4860A

10. Starting the copy cycle.

- Press the Start Key.

NOTE

To stop the copy cycle, press the Stop Key.

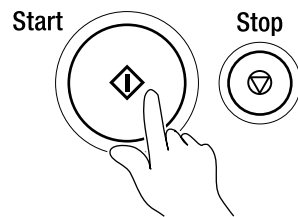

1179O009CB

NOTE

Some functions are not compatible with others when set at the same time. For more details, see "Function Combination Matrix." ☞ p.8-9

2. Placing Originals

Placing Originals on the Glass

Different methods are used to place the original depending on its type. Use the procedure appropriate for your original. If you are using a Duplexing Document Feeder, see p. 3-5

Sheet Originals

(Using plain paper or originals not suitable for the document feeder)

- 1 Raise the Original Cover or Duplexing Document Feeder and place the original face down on the Glass.

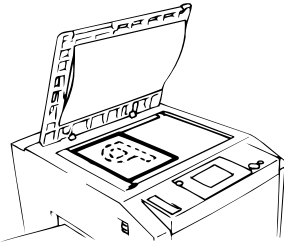

1179O048AA

- 2 Align the rear left corner of the original with the ▼ marker on the Width Scale of the copier glass.

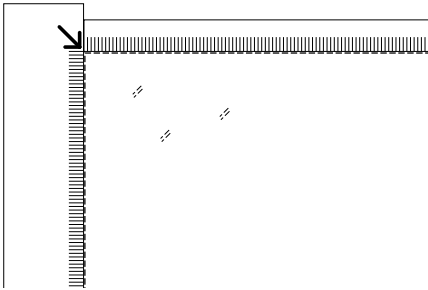

1144y001AA

Highly Transparent Originals

(Using transparencies and translucent paper for the original)

- 1 Place the original in the same way as the sheet originals.
- 2 Place a blank white sheet of paper of the same size over the original.

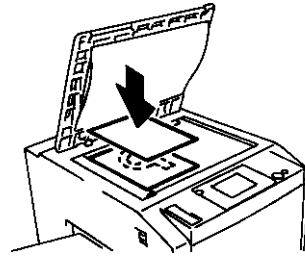

1179O049AA

- 3 Gently lower the Original Cover or Duplexing Document Feeder.

NOTES

- To make an 12×18 inch copy with a copier equipped with a Duplexing Document Feeder, align the rear left edge of the original with the ▼ (photo) mark on the Length Scale to avoid lost image. ☞ p.3-4
- To make copies using the Photo mode on a copier equipped with a Duplexing Document Feeder, align the rear left edge of the original with the ▼ (photo) mark on the Length Scale. ☞ p.3-4

- 3 Gently lower the Original Cover or Duplexing Document Feeder.

Making Copies from A Book Using Book Copy Mode

("Book" refers to an open bound original.)

- 1 Place the open book so that its top edge is at the rear of the copier and the center of the book is aligned with the Book Marker indicated on the Original Length Scale.

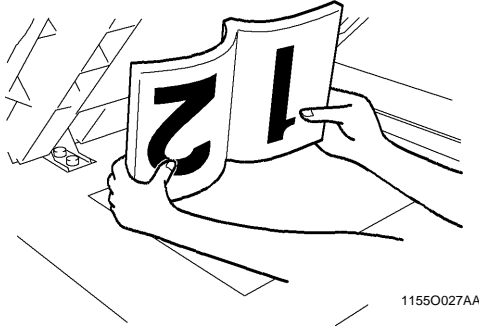

1155O027AA

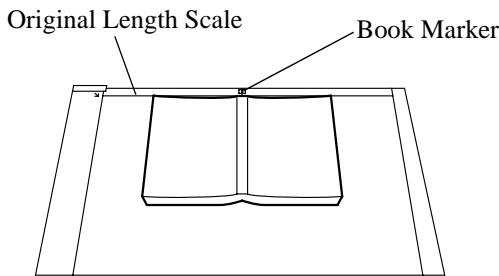

1154O003AA

- 2 Gently lower the Duplexing Document Feeder or Original Cover.

NOTES

- If the book is thick, make a copy with the Duplexing Document Feeder or Original Cover raised.
- Do not look directly at the Original Glass surface as a strong beam of light is emitted.
- Not positioning the open book properly will result in copies with pages in incorrect order.
- Start copying with the higher-numbered pair.

When Copier is Equipped with a Duplexing Document Feeder

Make sure of the correct placement of the original in any of the following cases if the copier is equipped with a Duplexing Document Feeder.

- Making copies in the Photo mode
- Making 12×18 inch copies

- 1 Place the original, by aligning the rear edge with the Length Scale and the left edge with the ▼ (Photo) mark.

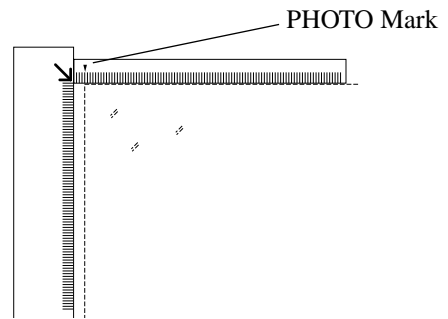

1144Y002AA

- 2 Gently lower the Duplexing Document Feeder or the Original Cover.
- 3 Make settings in the Photo Mode.
☞ p.3-33

Instructions for Original Placement

- Be sure to raise the Duplexing Document Feeder 15° or more before placing the original. If the Duplexing Document Feeder is raised to an angle less than 15°, the copier may fail to select the correct copy paper size or zoom ratio.

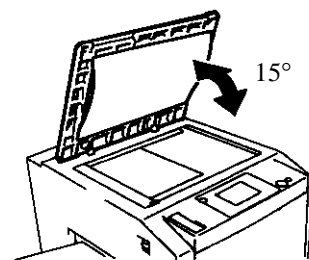

1179O050AA

- Do not place an original weighing more than 4-1/2 lb on the Glass.
- When placing an open book, do not press the book hard on the Glass, as the Glass could crack.

2. Placing Originals

Using the Duplexing Document Feeder

The Duplexing Document Feeder automatically feeds original sheets placed on the Document Feed Tray one by one. After the copy cycle has been completed, it automatically ejects the original onto the Document Exit Tray.

Some originals may not be suitable for reliable operation of the Duplexing Document Feeder. Here is a guideline.

Originals Suitable for the Duplexing Document Feeder

Type of Originals: Sheets (Plain paper)

Normal mode

- 1-Sided Original (weighing 13-1/4 lb to 29-1/4 lb)
- 2-Sided Original (weighing 16 lb to 24 lb)
- Mixed Original Detection mode (weighing 16 lb to 24 lb)

Original Size: 1-Sided Original, 2-Sided Original Mode : 11×17L to InvoiceL

2-in-1 (Dual Original Scanning) mode : LetterC

Mixed Original Detection mode : 11×17L to Letter

Originals Not Suitable

- Typing paper, paraffin paper, and other thin paper
- Thick paper
- Originals greater than 11×17L or smaller than InvoiceL
- Transparencies, translucent paper
- Wrinkled, dog-eared, curled, or torn originals
- Clipped or stapled originals
- Carbon-backed originals

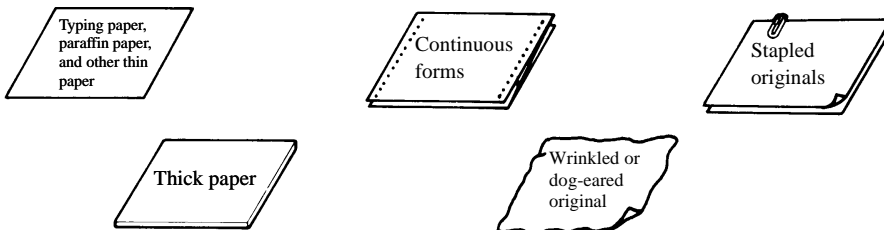

1134O073AA

NOTE

For any of these types of originals, raise the Duplexing Document Feeder and place the original manually on the Glass to make a copy. ☞ p.3-3

Loading the Originals

- 1 Slide the Document Guide Plate to the size of the originals.
*When using large size originals, flip up the Document Feed Tray Extender.

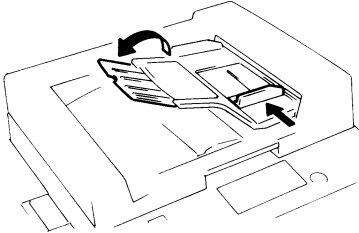

1151O015AA

- 2 Load a neat stack of originals face up on the Document Feed Tray.

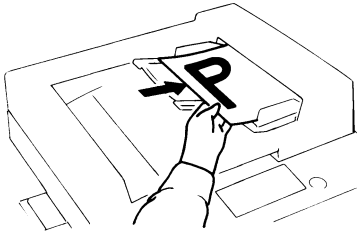

1151O016AA

NOTES

- *The maximum number of originals that can be loaded*
Letter or smaller : Up to 50
Larger than Letter : Up to 30
- *Make sure that the top level of the original stack does not exceed the ▼ marking.*
- *Make sure that the Document Guide Plate is in touch with the edges of the original stack. If it's not pressed snugly against the original stack, skewed feeding could result.*

2. Placing Originals

Using the Single Automatic Document Feeding Mode (SADF Mode)

This is the mode in which you insert your originals one by one into the Duplexing Document Feeder to make a copy or copies from it. When you load the original, the copier automatically starts the copy cycle.

NOTES

- *Originals available for the SADF Mode.*

Type : Plain paper
 Thickness : 9-1/4 lb to 53-1/4 lb
 Size : 11×17L to InvoiceL

- *The following features cannot be selected in the SADF Mode.*

2-sided original ▶ 1-sided copy	Staple Mode
2-sided original ▶ 2-sided copy	Color Separation
Dual Original Scanning Mode (2-in-1 Mode)	Image Repeat
Book Mode	Photo Mode
Cover Mode	

Chapter 3
Making Copies

- 1 Open the Document Feed Tray and slide the Guide Plate to the size of the original.

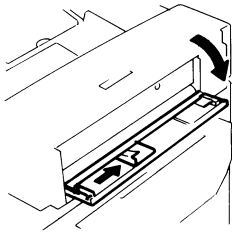

11510018AA

- 3 The original is automatically taken up and the copy cycle is started.

- 4 Making sure that the Start Key lights up green again, load the next original.

- 2 Make sure that the Start Key is lit green and insert the original face down into the Document Feed Table.

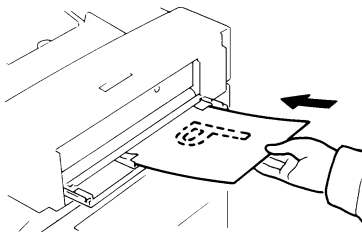

11510019AA

NOTES

- *Be sure to place one original at a time.*
- *Be sure to correct any fold or curl in the original.*

3. Basic Functions

We here explain how to select the basic settings to make copies.

Density key:
Touch this key to show the screen that allows you to select the image density of the copy.
☞ p.3-17

The screenshot shows the 'Basic Screen' with a 'Ready to copy.' status. It features three main columns: 'Density' with an 'Auto' key, 'Zoom' with a 'x 1.000' key, and 'Paper' with an 'Auto Paper' key. Below the 'Paper' key is a 'Photo Mode' key. At the top, there are tabs for 'Digital Art', 'Color Adjust', 'Input Output', and 'Basics'. A '1' is displayed in the top right corner.

Zoom key:
Touch this key to show the screen that allows you to select the zoom ratio.
☞ p.3-13

Paper key:
Touch this key to show the screen that allows you to select the paper size.

Copy Paper Size

Auto Paper

When this key is touched, the copier is set to the Auto Paper mode where the copy paper is automatically selected according to the size of the original being used and the zoom ratio selected for use.

- 1 Touch **Paper** on the Basic Screen, then touch **Auto Paper** to set the copier into the Auto Paper mode.
- 2 Touch **OK**.

Useful Tip

This mode is efficient when you want to automatically make copies on paper of the same size as your originals.

NOTES

- When the original is placed on the Original Glass, the original sizes that can be detected in the Auto Paper mode are 11×17L, LegalL, LetterL, LetterC, InvoiceL, B4L, B5C. The copier may fail to detect, or wrongly detect, any other standard size and irregular sizes. (But, there are optional parts that can be mounted to enable detection of A3L, A4L, A4C, B5L, InvoiceC, and FNS (8-1/4×13L) ; ask your Tech. Rep. for these capabilities.)
- When using the Document Feeder, the original sizes that can be detected in the Auto Paper mode are 11×17L, LegalL, LetterL, LetterC, InvoiceL, and InvoiceC. (Invoice size paper cannot be used for the Mixed Original Detection Mode.)

- The copier fails to detect, or wrongly detect, the size of a wrinkled, dog-eared, or curled originals.

Manual Selection

The copy paper size can be set manually according to your need.

- 1 Touch **Paper** and the Touch Panel indicates the paper size currently loaded in the three Paper Trays.

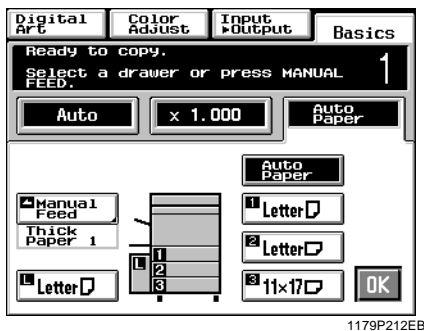

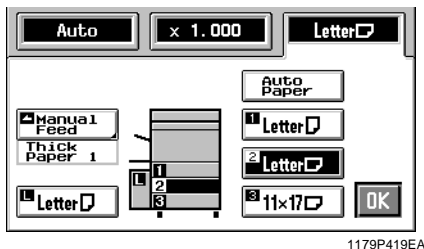

- 2 Touch the desired paper size key.



- 3 Touch **OK**.

Paper Type Setting

If nonstandard paper has been set for any of the paper sources, the symbol , , or  appears on the paper select key on the Touch Panel.

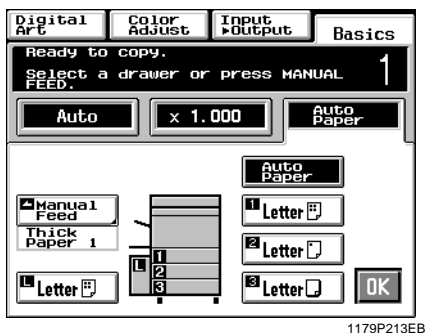

The following three different types of paper can be designated for each paper source.

 : Plain Paper (20 to 24 lb)

When this setting is made, the paper source can be a candidate for Auto Paper.

 : Thin Paper (20 lb)

This setting excludes the paper source from selection for Auto Paper. Make this setting for the source loaded with thin paper to prevent the paper from being used for a wrong purpose.

 : Thick Paper 1 (24 to 34 lb)

This setting excludes the paper source from selection for Auto Paper. Make this setting for the source loaded with thick paper to prevent the paper from being used for a wrong purpose.

The paper type settings are to be made by your Technical Representative. For more details, consult your Technical Representative.

NOTE

Only Plain Paper can be used for 2-sided copies.

Auto Tray Switching

If the tray currently selected for use runs out of paper and there is another tray loaded with paper of the same size and in the same direction, the copier automatically selects that second tray to continue copying.

Useful Tip

This feature is a great advantage when you need to make a large number of copies on the same size paper. For example, you can make up to 1,250 copies without interruption if all three trays are loaded with paper of the same size and in the same direction. You can even make up to 2,350 copies if an optional Large Capacity Cassette is additionally fitted to the copier.

A tray with any kind of paper other than Plain paper can also be set as a candidate for Auto Tray Switching. For more details, consult your Technical Representative.

Manual Bypass Copying

- Use the Manual Bypass to make copies on paper not loaded in any tray, or to copy onto OHP transparencies or any other special paper.
- The setting of copy paper sizes is needed for manual bypass copying.

Copy Paper that Can be Used for Manual Bypass

◆Types of Paper

- Plain Paper (20 lb to 24 lb)
- Thin Paper (20 lb)
- Thick Paper
 - Thick Paper 1 (24 lb to 34 lb), Thick Paper 2 (50 lb to 80 lb cover)
- OHP films (recommended brand)

◆Paper Size

- 11×17L to LetterC and 12×18L
- Postcard
- Max. Size: 11-3/4 ×17
- Minimum Size: 5-3/4 ×7-1/4

◆Capacity of the Manual Bypass Tray

- Thin Paper, Plain Paper, Thick Paper 1 ... Up to 90 sheets
- Plain Paper/Thin Paper (once-copied paper), Thick Paper 2 ... Up to 50 sheets
- OHP films ... Up to 40 sheets.

Using the Manual Bypass Tray

- 1 Place the original on the Original Glass.
- 2 Swing down the Manual Bypass Tray.

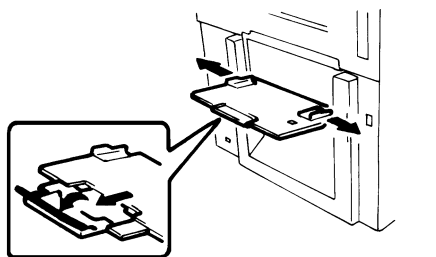

1144O012AA

- 3 Insert a neat stack of copy paper into the Manual Bypass Tray until it stops and slide the Paper Guide Plates to the size of the copy paper.

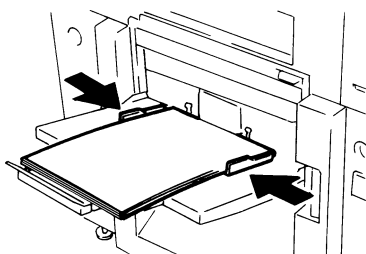

1144O013AA

NOTES

- Load the OHP films so that the front side (on which the white line is printed) faces up in the direction as shown.

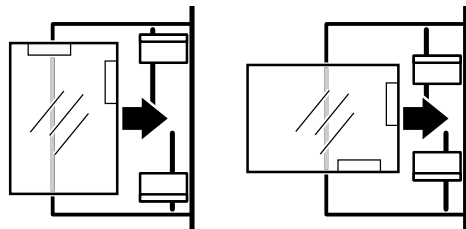

1179O056AA

- Use only the recommended OHP films.
- Only Plain Paper can be used for 2-sided copies.
- When inserting paper with one side previously printed, load the paper stack so that the blank side faces down.
- Make sure that the top level of the original stack does not exceed the ▼ marking.

- 4 Select a copy paper size. If the copy paper is non-standard size, touch **Custom Size**.

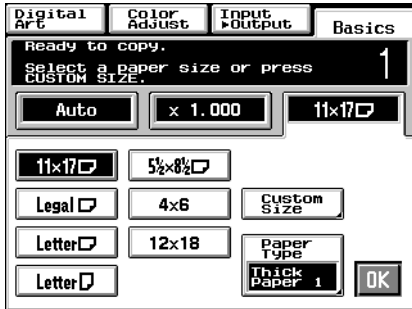

1179P214EB

- 5 Touch **Paper Type** and select the type of copy paper.

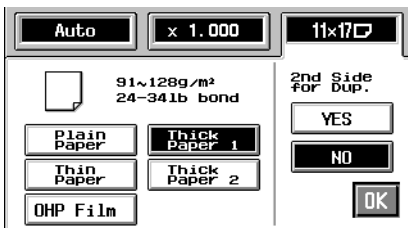

1179P215EB

- 6 If this is going to be the copy cycle for making the first side of the copy, select **No** for 2nd Side for Dup. If this is going to be the copy cycle for making the second side of the copy, select **Yes**.

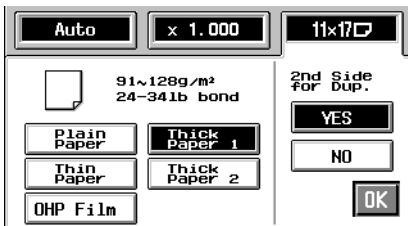

1179P216EB

Useful Tip

The copy is also made on the lower face of the copy paper loaded in the Bypass Tray when **Yes** of 2nd Side for Dup. is selected.

- 7 Touch **OK**.

- 8 Make the necessary copy function settings.

Useful Tip

Using 12x18 inch paper ensures a good copy of the entire image of an 11x17 inch original with no void images.

NOTES

- The following functions cannot be set for Manual Bypass copying:
1 ▶ 2, 2 ▶ 2, 1 ▶ 2[2in1], Book ▶ 2, Sort, Group, Staple
- When a copy is made on OHP films fed into a Sorter or Staple Sorter, try to remove the copy (OHP films) from the bin as soon as it is fed in. If the copy is left a while in the bin, it can curl.

<If the original is non-standard size>

Touch **Custom Size** on the screen given in step 4.

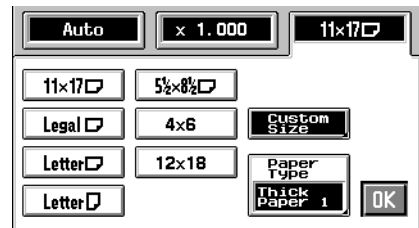

1179P415EA

Touch **X** and enter the length of the copy paper from the 10-Key Pad. Then touch **Y** and enter the width of the copy paper from the 10-Key Pad.

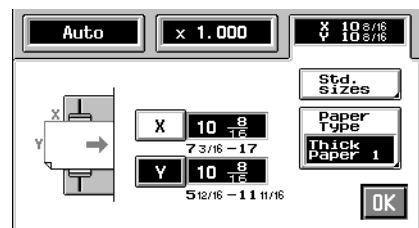

1179P416CA

Touch **OK**.

Zoom Ratio

When you touch **Zoom** on the Touch Panel, a screen appears that allows you to set the zoom ratio. You have six different ways to choose from to set the zoom ratio. Select one according to your need.

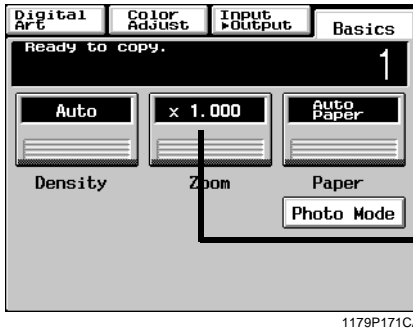

1179P171CA

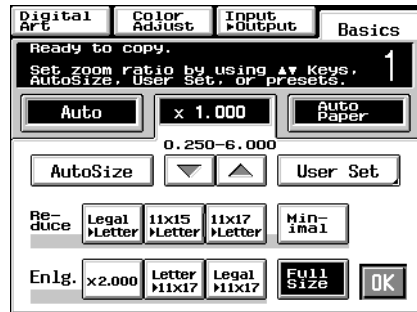

1179P217EA

Auto Size

In the Auto Size mode, the copier automatically selects the zoom ratio according to the size of the original being used and the copy paper size selected for use.

- 1 Touch **Auto Size** to set the copier into the Auto Size mode.

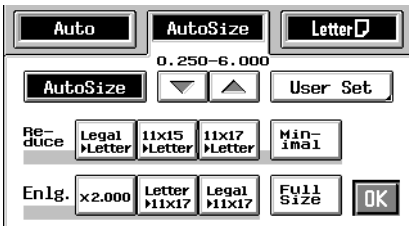

1179P432EA

- 2 Select the paper size.
- 3 Touch **OK**.

Useful Tip

This mode is very helpful for neat filing when you need to make copies from originals of assorted sizes.

Selecting a Ratio from among Fixed Ones

The copier provides most frequently used zoom ratios ready for immediate use.

- 1 Touch the appropriate original-to-copy-size representation key. You have three reduction and three enlargement ratios.

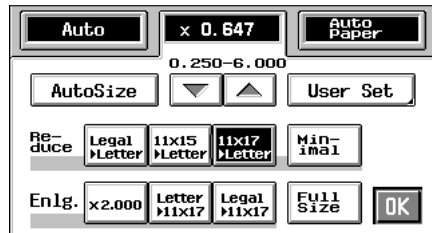

1154P336EB

When you touch **Full Size**, full size (×1.000) is selected.

NOTE

When the document feeder is used, the copier determines the zoom ratio when the first original is taken up and fed in and uses that zoom ratio for the subsequent originals (except in the Mixed Original Detection mode.)

- 2 Touch **OK**.

For a Slightly Smaller Image

This function lets you make a copy slightly reduced in image size from that of the original.

- 1 Touch **Minimal**.

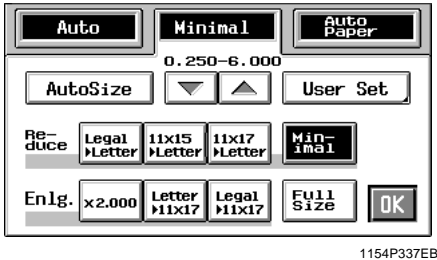

Useful Tip

It comes in handy for making a copy, without losing any portion of the original image, from an original which has an image area covering its entire surface.

- 2 Touch **OK**.

Using Zoom Up/Down Keys

Pressing the or key changes the zoom ratio in 0.001 increments. You can keep touching the key to change the ratio quickly.

- 1 Hold down the or key until the desired zoom ratio is reached.

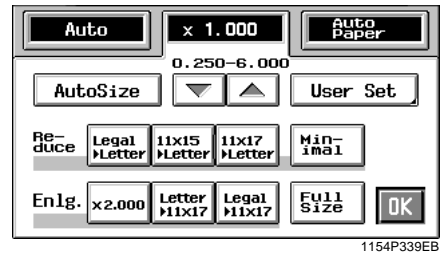

Useful Tips

- To save time, first select the fixed zoom ratio nearest to the target ratio before using the or key.
- You can change the zoom ratio between the range of $\times 0.250$ and $\times 6.000$

- 2 Touch **OK**.

3. Basic Functions

Using the 10-Key Pad

You may use the 10-Key Pad to directly enter the zoom ratio.

- 1 Touch **User Set**.

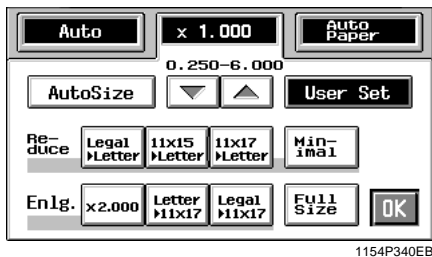

1154P340EB

- 2 Enter the desired zoom ratio from the 10-Key Pad.

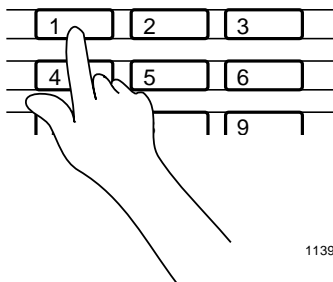

1139O4870A

Example: $\times 1.300$

Press 1, 3, 0, and 0, in that order.

$\times 1.300$

1149O160BA

To correct a ratio, press the Clear key and then enter the correct one again.

Useful Tip

The zoom ratio can be entered between the range of $\times 0.250$ and $\times 6.000$.

- 3 Touch **OK**.

Calling up a Ratio from Memory

You can store some of the most frequently used zoom ratios in memory and recall them later as necessary.

- 1 Touch **User Set**.

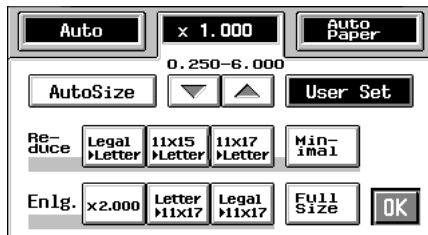

1154P340EB

- 2 From among the three ratios previously stored in memory, select the desired one.

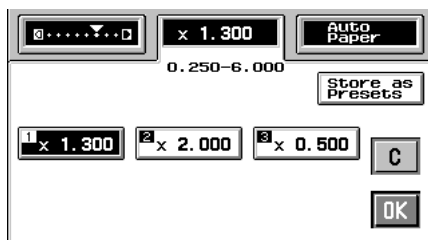

1179P404EA

Useful Tip

It's a good idea for you to store frequently used zoom ratios in memory. ☞ p.3-16

- 3 Touch **OK**.

Storing a Ratio in Memory

1 Touch **User Set**.

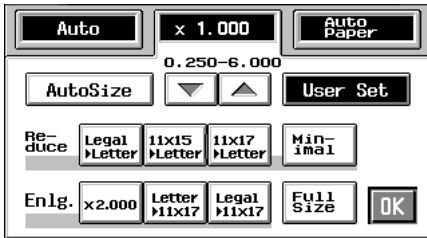

1154P340EB

2 Enter the desired zoom ratio from the 10-Key Pad.

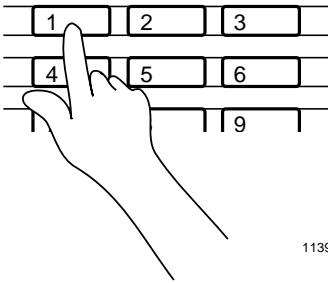

1139O4870A

Example: $\times 1.300$

Press 1, 3, 0, and 0, in that order.

x 1.300

1149O160BA

To correct a ratio, press the Clear key and then enter the correct one again.

Useful Tip

The zoom ratio can be entered between the range of $\times 0.250$ and $\times 6.000$.

3 Touch **Store**.

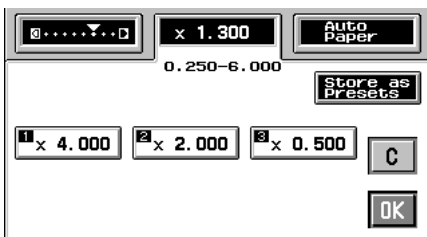

1179P405EA

4 Touch the memory location key in which to store the set zoom ratio.

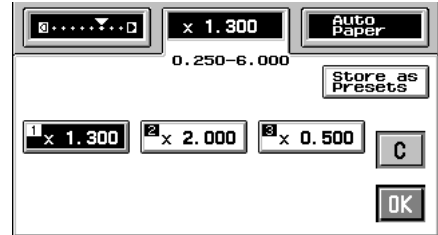

1179P404EA

*When the key is touched, the ratio is shown on the key, indicating that it has been stored in memory.

NOTE

When a new ratio is stored, the old one is erased.

5 Touch **OK**.

Image Density

Touch **Density** on the Touch Panel. Then, a screen appears that allows you to adjust the image density and background level of the copy.

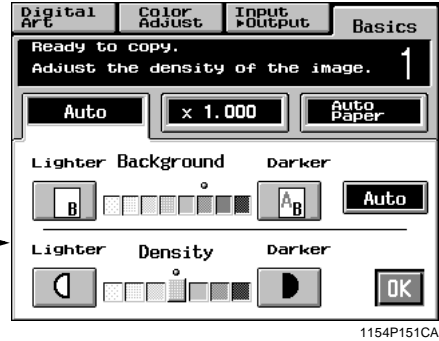
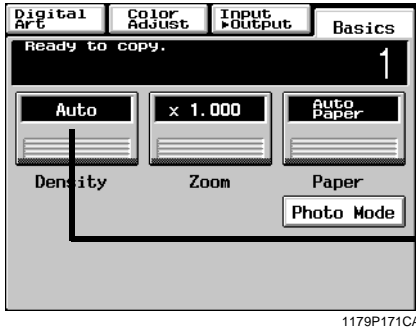

Adjusting the background level:

Slide the level towards the Lighter side if you don't want the data on the back side of a newspaper or magazine page copied. Slide it towards the Darker side if you want to reproduce pale colors of a bright area of the original.

When you adjust the level towards the Darker side, the copier also copies the background. If you slide the level towards the Lighter side, the resultant copy will become lighter. Select the appropriate level according to your original.

Adjusting the background level

Auto Exposure

The copier automatically selects the best possible background level. If you make a black-and-white copy from an original which is a faint pencil-written text, the copier automatically makes the text darker as it appears on the copy.

- 1 Touch **Auto**.
The **Auto** key is highlighted, indicating that the copier is set into the Auto Exposure mode.

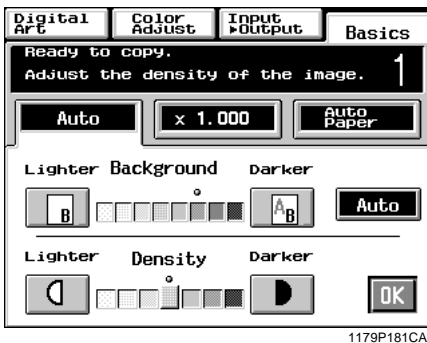

- 2 Touch **OK**.

Manual Exposure

In the Manual Exposure mode, you can vary the exposure level in eight steps.

- 1 Touch **Lighter** or **Darker** as necessary.

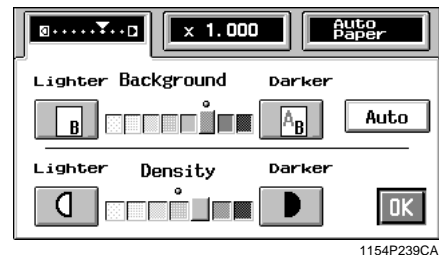

- 2 Touch **OK**.

Adjusting the Image Density

Manual Exposure

In the Manual Exposure mode, you can vary the exposure level in seven steps.

- 1 Touch **Lighter** or **Darker** as necessary.

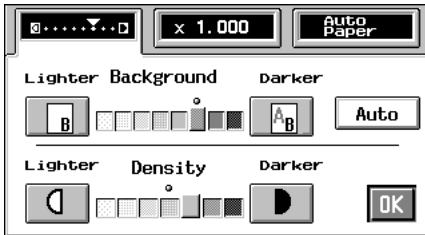

1154P239CA

<To make the image darker>

Touch **Darker** .

<To make the image lighter>

Touch **Lighter** .

- 2 Touch **OK** .

4. Input ▶ Output Mode

When you touch **Input ▶ Output** on the Touch Panel, a screen appears that allows you to set the original ▶ copy type or a particular finishing function.

Choose the setting based on your original and your desired end-result copy.
 ☞ p.3-21

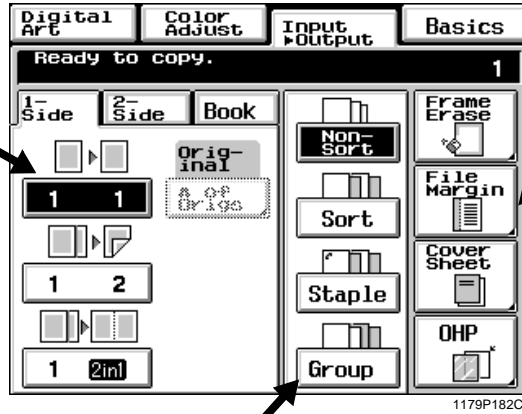

If required, select the appropriate special function(s). ☞ p.4-1

Select a finishing function you want to use for your copies. (Only when the optional Sorter or Staple Sorter is mounted) ☞ p.3-25

* The screen may appear different depending on the options your copier is equipped with.

Original ▶ Copy Types

1 ▶ 1 Originals Copies • Select 1 ▶ 1 to make 1-sided copies from 1-sided originals.

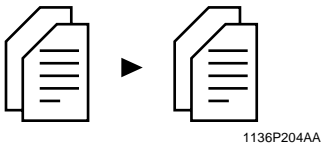

Touch

1 ▶ 2 Originals Copy (Only when the Duplex Unit is mounted.) • Select 1 ▶ 2 to make 2-sided copies from 1-sided originals.

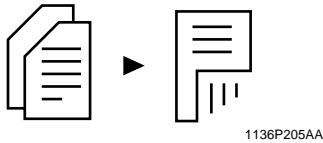

NOTE
 Two originals can be copied onto one sheet of paper.

Touch

2 ▶ 1 Original Copies (Only when the Duplexing Document Feeder is mounted.) • Select 2 ▶ 1 to make 1-sided copies from 2-sided originals.

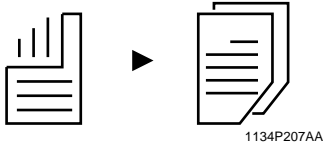

NOTE
 You need twice as many sheets of copy paper as originals.

Touch

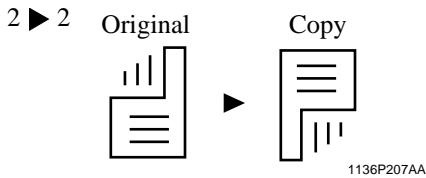

(Only when the Duplexing Document Feeder and Duplex Unit are mounted.)

- Select 2 ▶ 2 to make 2-sided copies from 2-sided originals.

Touch

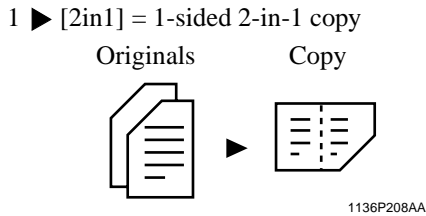

(Only when the Duplexing Document Feeder is mounted.)

- Select 1 ▶ [2in1] to make a 1-sided copy, through reduction, from two 1-sided originals side-by-side.

NOTES

- You need half as many sheets of copy paper as the number of originals.
- The size of the original should be LetterC for 2-in-1.

Touch

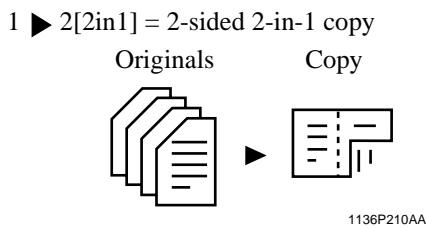

(Only when Duplexing Document Feeder and Duplex Unit are mounted.)

- Select 1 ▶ 2[2in1] to make a 2-sided copy, through reduction, from four 1-sided originals. Each pair of originals will be placed side-by-side on either side of the copy.

NOTES

- You need 1/4 as many sheets of copy paper as the number of originals.
- The size of the original should be LetterC for 2-in-1.

Touch

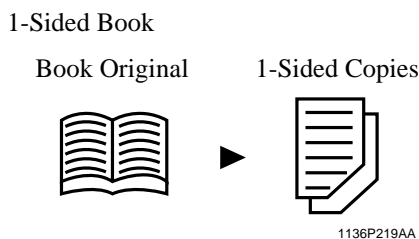

Each of the two pages of an open book is copied onto one side of a separate sheet of paper.

Touch , then

touch or

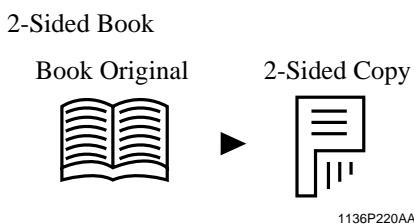

(Only when the Duplex Unit is mounted.)

The two pages of an open book are copied onto opposite sides of a sheet of paper.

Touch , then

touch or

NOTE

Only Plain Paper can be used for 2-sided copies.

Selecting Input ▶ Output Mode

1 Touch **Input ▶ Output**.

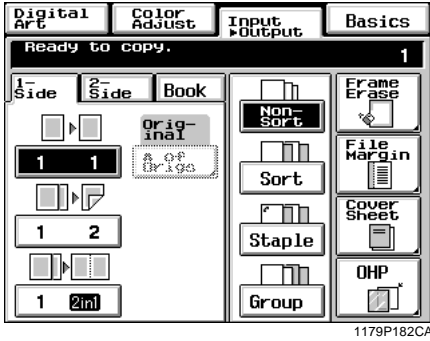

2 Touch the key corresponding to the desired original-to-copy type.

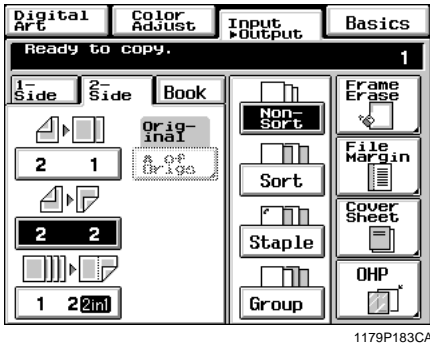

NOTES

• When you make copies from a book, select the correct key according to whether the book is bound on the left or on the right (R-Book).

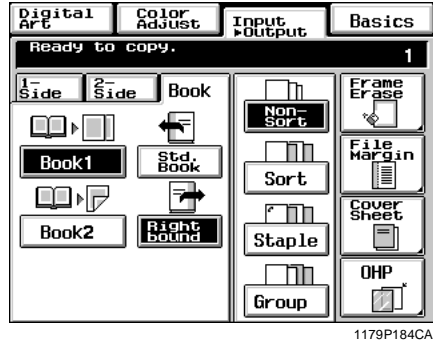

• When making copies in 1 ▶ 2, 1 ▶ (2in1), or 1 ▶ 2 (2in1) mode, input the number of originals. ↪ p.3-22

Useful Tip

The original-to-copy type separates options into 1-Sided, 2-Sided, and Book. Touch any of these base keys **1-Side**, **2-Side**, and **Book** to make settings in greater detail.

Input the number of originals

- If you're going to make copies using 1 ► 2, 1 ► [2in1] or 1 ► 2-[2in1], you need to input the number of your originals. Then the copier can arrange the pages in correct order.

When you know the number of originals

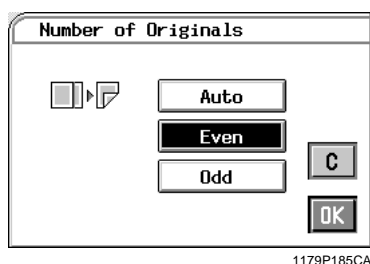

1179P185CA

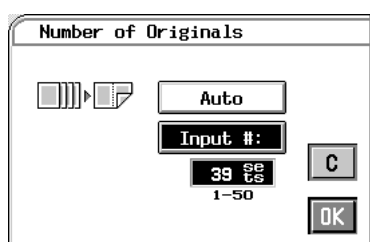

1179P186CA

Setting Even/Odd

- ① Touch **# of Origs**.
- ② Touch **Even** or **Odd** as appropriate.
- ③ Touch **OK**.

Using the 10-Key Pad

- ① Touch **# of Origs**.
- ② Touch **Input #**.
- ③ Enter the number of originals from the 10-Key Pad.

NOTES

- The maximum number of originals you can set is 50.
- To correct a wrong number, press the Clear key, then enter the correct number.

- ④ Touch **OK**.

If you want the document feeder to count the number of originals for you

Select **Auto** to let the document feeder count the number of originals.

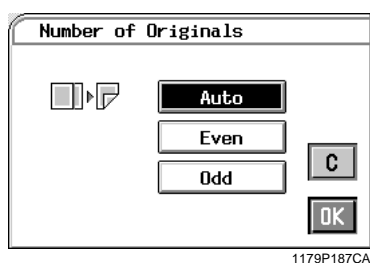

1179P187CA

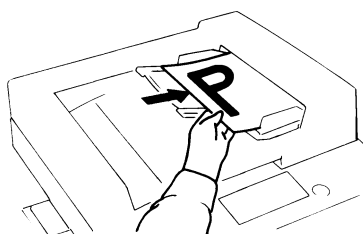

1151O016AA

- ① Touch **# of Origs**.
- ② Touch **Auto**.
- ③ Touch **OK**.
- ④ Load your originals into the document feeder.
- ⑤ Press the Start Key.
 - *The document feeder starts feeding the originals loaded in it to count the number of originals. (At this time, no copy cycle is run.)
- ⑥ Unload the originals ejected onto the Document Exit Tray and reload them onto the Document Feed Tray. Then, press the Start key to make copies.

Mixed Original Detection Mode

You may sometimes need to make copies from originals of assorted sizes and perhaps you want to use the Duplexing Document Feeder mounted on your copier. You can by using this function.

In the default settings, the **Mixed Size** key does not appear on the Touch Panel, indicating that the Mixed Size function is turned ON. When a black copy, 1▶1, and manual background adjustment is selected, however, the **Mixed Size** function can now be disabled with the **OFF** key that appears on the Touch Panel together with **ON** key.

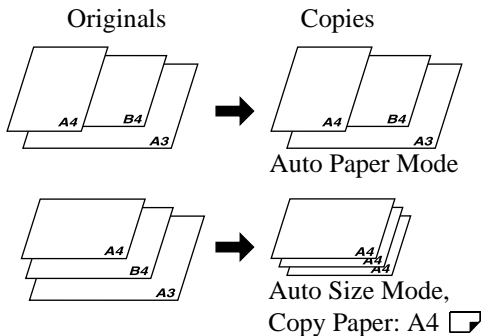

11380537AA

NOTE

The copier cannot staple together the copies of different sizes made in the Mixed Original Detection mode.

Using the Mixed Original Detection Mode

1 Load the stack of originals so that the rear edge of each original is pressed against the rear Document Guide Plate. Then, slide the front Document Guide Plate against the front edges of the widest originals.

* When using large size originals, flip up the Document Feed Tray Extender.

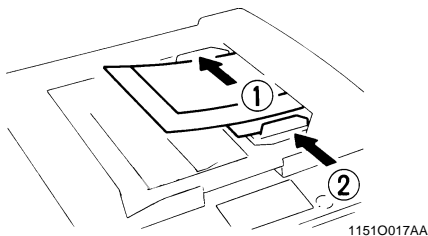

11510017AA

2 Touch **Input ▶ Output**.

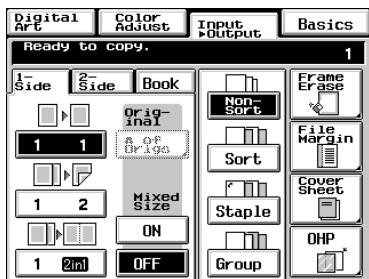

1179P188CA

3 Select **ON** or **OFF** for the “Mixed Size.”

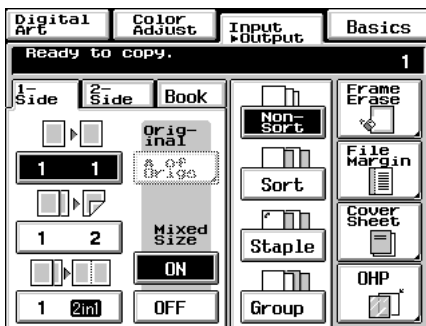

1179P189CA

NOTE

This function cannot be set when the copier is set in the Interrupt, OHP Interleaving, Cover Sheet, Monotone, or Background Color mode.

Instructions for Loading Originals

Use the following procedure for loading originals to make 1-sided copies from 2-sided originals.

Procedure

Load the originals crosswise.

If the originals are loaded lengthwise, the directions of the copy images will be mixed up.

Correct:

2-Sided Originals
Loaded Crosswise

1-Sided Copies

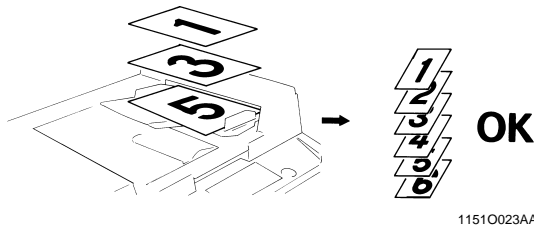

1151O023AA

Incorrect:

2-Sided Originals
Loaded Lengthwise

1-Sided Copies

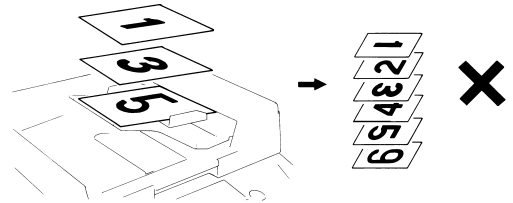

1151O022AB

Precautions for Book Copying

- Place the open book so that its top edge is at the rear of the copier and the center of the book is aligned with the Book Marker indicated on the Original Length Scale.
- Make copies in descending order of page.
- Select the desired zoom ratio and copy paper size.

Placing the Book on the Glass Correctly

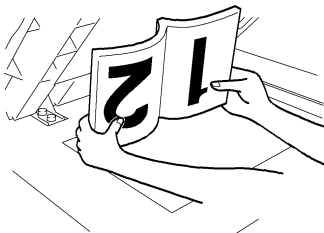

1155O027AA

Original Length Scale

Book Marker

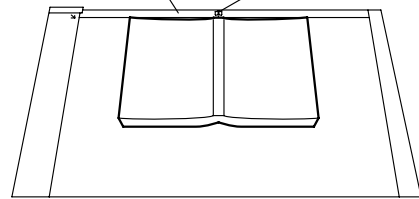

1154O003AA

Precautions for 2-in-1 Copying

When the 2-in-1 mode is selected, the copier automatically selects a reduced zoom ratio. However, you can choose another zoom ratio by changing the User's Choice setting. ☞ p.5-19

Finishing Modes

Non-Sort

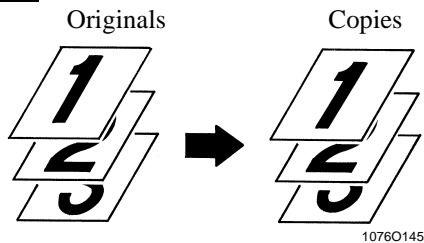

All copies are fed to the 1st Bin, without being sorted, grouped, stapled, or punched.

Touch **Non-Sort** .

NOTE

Manual Bypass Copying cannot be used for Sort, Group, or Sort Staple mode.

Sort

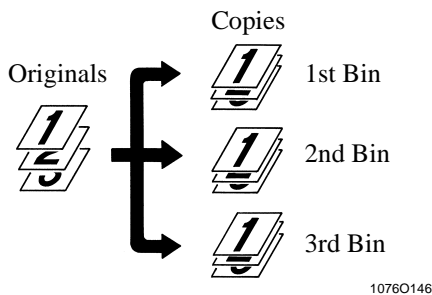

(Only when the Sorter or Staple Sorter is mounted)
Copies are sorted into complete sets of the originals.
* This mode is effective when making multiple copies from multiple originals.

Touch **Sort** .

Sort-and-Staple

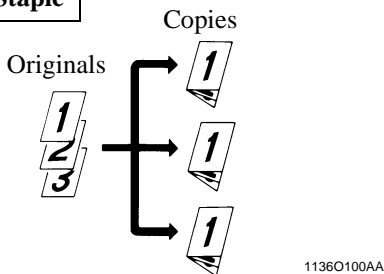

(Only when the Staple Sorter is mounted)
Copies are sorted into complete sets of the originals and each set is stapled together.

Touch **Staple** .

Group

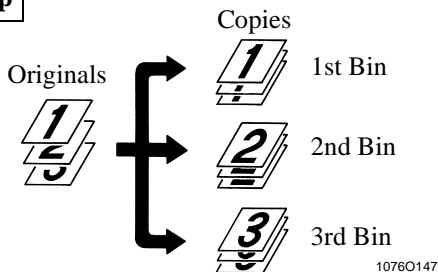

(Only when the Sorter or Staple Sorter is mounted)
The copies made from each single original are separated into groups. Each group contains the same number of copies.

Touch **Group** .

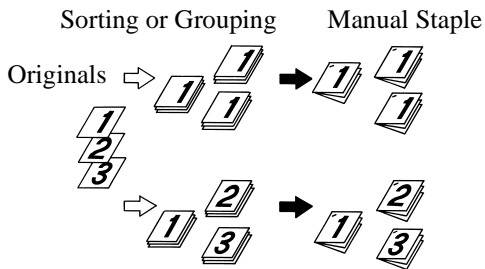
Manual Staple

(Only when the Staple Sorter is mounted)

This mode allows you to staple copy sets already made in the Sort Mode or copy stacks made in the Group Mode.

Touch **Staple** on the Basic Screen.

*This feature is efficient for stapling originals after making copies. ☞ p.3-27

Useful Tip

In the initial mode, the copier automatically switches between Non-Sort and Sort depending on the number of originals loaded in the Duplexing Document Feeder and the number of copies to be made. User's Choice can, however, be used to disable this function. ☞ p.5-19

Using Manual Staple Mode

To use as a stapler:

1 Align the sheets of paper neatly.

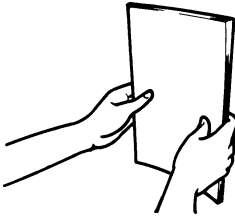

1134O039AA

2 Insert the paper stack into the 2nd Bin.

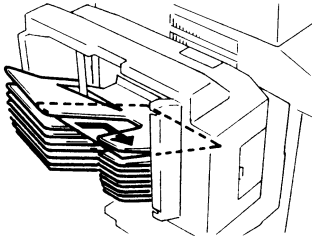

1144O488AA

NOTE

Up to 25 sheets of (plain) paper can be stapled.

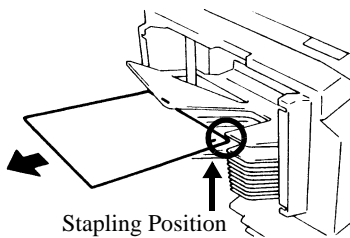

Stapling Position

1144O489AA

NOTES

- Make sure of the stapling position and press the paper stack against the bracket.
- Never attempt to reach for the stapling position. This can be dangerous.

3 Touch **Staple**.

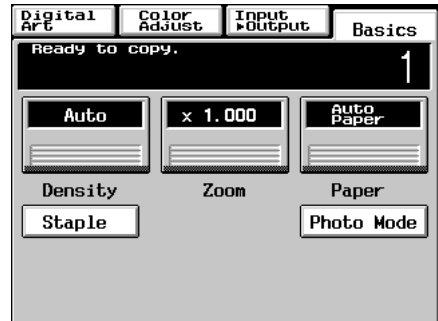

1179P190CA

- The sheets of paper are stapled.

Useful Tip

This feature is efficient to staple originals after making copies.

Original Direction for Stapling

If the originals are loaded in the Duplexing Document Feeder as shown, the stapling corner is at the rear left side as indicated by the arrow.

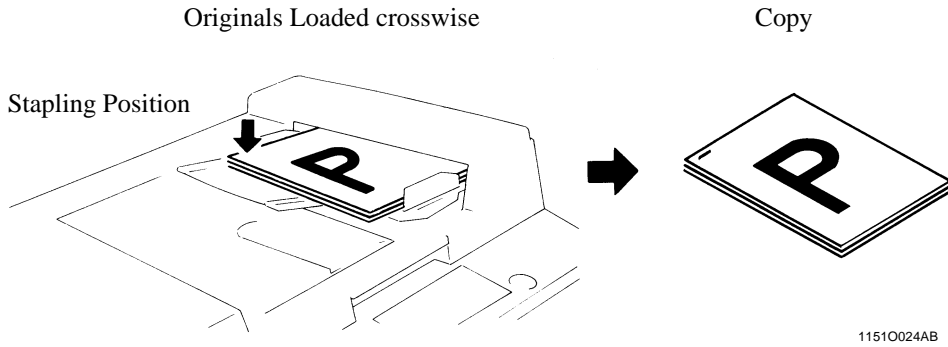

If the originals are placed on the Original Glass as shown, the stapling corner is at the rear right corner as indicated by the arrow.

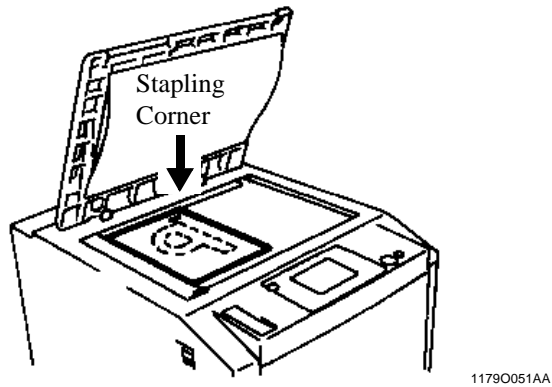

4. Input ► Output Mode

Auto Dual Function in the Sort Mode

Each of the Sort Bins holds up to 25 sheets of paper. The Auto Dual Function, however, allows sorting of copies of up to 50 originals under certain conditions.

When less than 5 copies are made from an original set consisting of more than 25 originals, in the Sort Mode the Sorter or the Staple Sorter is automatically switched into the Auto Dual Function Mode using the 6th to 10th Bins.

Copies	Bins Used
1st to 25th sorted copies	1st to 5th Bins
26st to 50th sorted copies	6th to 10th Bins

- * If the number of copies selected exceeds 5, the copy cycle stops at the 25th original.
- * To have a complete set of originals, place the copies from the 6th Bin on top of those from the 1st Bin. In the same way, place the copies from the 7th Bin on top of those from the 2nd Bin, and so on.

When the Number of Copies Selected Exceeds 25 in the Group Mode

When more than 25 copies are to be grouped together into one group, the Staple Sorter uses the next Bin to continue grouping the copies.

Original	Copies	Bins Used
1st	1st to 25th copies	1st Bin
	26st and subsequent copies	2nd Bin
2nd to Nth: Same way up to 10th		

If the Number of Copies Selected Exceeds 50 in the Non-Sort Mode

The capacity of the 1st Bin is 50. If more than 50 copies are made in the Non-Sort mode, the Sorter uses the 1st, 2nd, and subsequent Bins to hold those excess copies.

Auto Dual Function in Sort-and-Staple Mode

When 5 or less copies are made from an original set consisting of more than 26 originals in the Sort-and-Staple Mode and the Auto Dual function is activated, the Sort-and-Staple Mode is automatically switched to the Sort Mode (no stapling takes place.)

5. Color Adjust Mode (Basic)

When you touch **Color Adjust** on the Touch Panel, a screen appears that allows you to simply adjust the hue or tone of the color produced on the copy and how you would like the color of your copy to look. The copier also allows you to professionally adjust these features. ☞ p.4-11

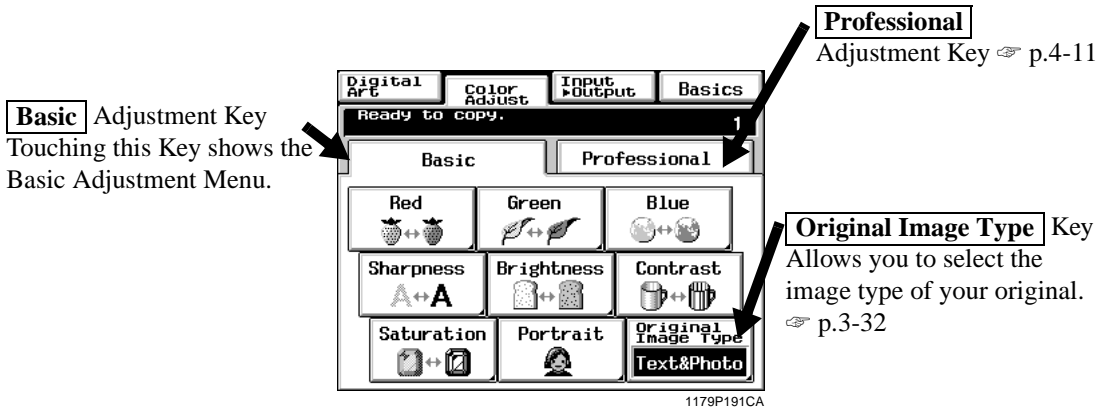

For copy samples, see the “Creative Image Book” separately provided.

Basic Adjustment Items

Red

Adjusts only the red component of the original to make it appear redder or less red.

Green

Adjusts only the green component of the original to make it appear greener or less green.

Blue

Adjusts only the blue component of the original to make it appear bluer or less blue.

Sharpness

Enhances the outline of characters, making it sharper or less sharp.

Brightness

Adjusts to make the original image brighter or darker.

Contrast

Makes an original image look less distinct or a blurred image look clearer and more distinct.

Saturation

Makes the colors appear duller or vivid.

Portrait

Adjusts the flesh tone of the portrait.

Color Adjust Procedure (Basic)

- 1 Touch the **Basic** key and select the item for adjustment.



1179P191CA

- 2 Touch the Test Print key.
(Ex.: When "Sharpness" is selected)

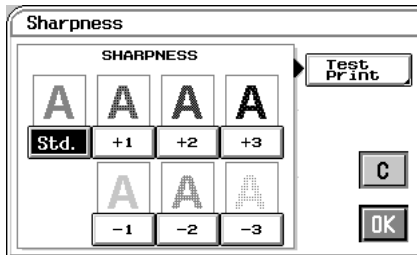

1179P192CA

- 3 Position the image area in the original you want to check for color in the Test Area on the Glass.

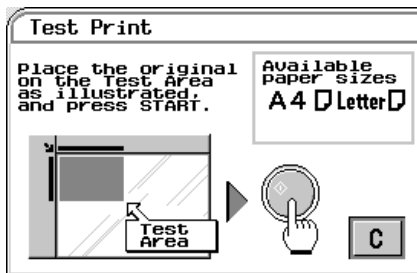

1179P193CA

- 4 Press the Start Key. This causes the copier to output a sample copy showing seven images, each representing a different level of adjustment for the selected item.

- 5 Select the sample you like best, then touch **OK**.

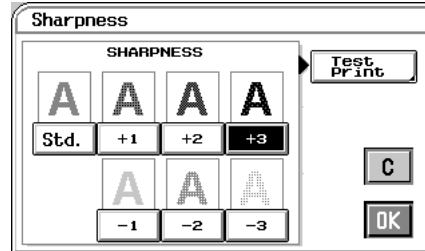

1179P194CA

- 6 Place the original in position again and press the Start Key.

NOTE

The size of paper should be A4C or LetterC for test print.

Selecting the Original Image Type

Select the original image type by pressing the corresponding key to get the best possible result on your copy.

Text & Photo

This mode is ideally suited to an original which contains texts, photos, and illustrations. This feature is selected in the initial mode.

Photo Image

Select this mode to make a clear copy from a photo printed on photographic paper.

Printed Image

When making a copy from a gravure photo of a magazine, this mode is effective in preventing moire from occurring on the copy.

Text

This mode is just right for making copies from an original that contains texts and fine lines.

Map

If you want to make a copy from an original which has a text on a relatively dark colored background, such as a map, this mode is just right for the job reproducing fine letters and lines clearly. This feature is also effective in reproducing faint pencil-written texts clearly.

1 Touch **Original Image Type** .



1179P191CA

3 Touch **OK** .

2 Select the desired image type of your original.

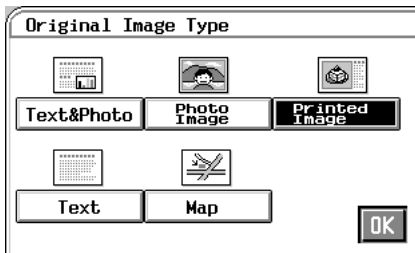

1179P195CA

6. Photo Mode

Photo mode is effective in making copies from photos, allowing you to place the photo image on the copy at an aesthetically pleasing position. Photo-Sizing offers you a choice between **Scale to Page**, with which the image is scaled to fill the entire surface of the copy paper, and **Manual Zoom Input**, with which you need to manually specify the zoom ratio for the copy. Touching the **Photo Mode** sets the copier into the Photo mode.

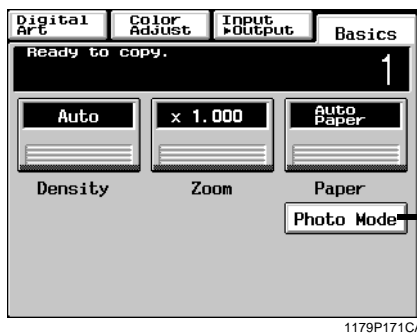

1179P171CA

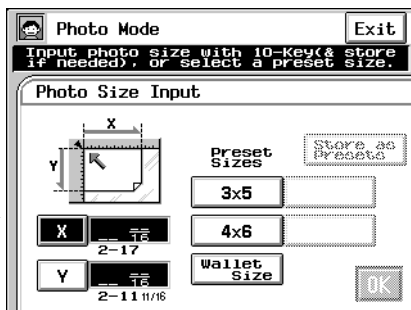

1179P218EA

Making Copies from a Photo

Photo-Sizing Mode: Scale to Page

- 1 Select the size of your photo and touch **OK**. If an appropriate size is not available, enter the size from the 10-Key Pad.

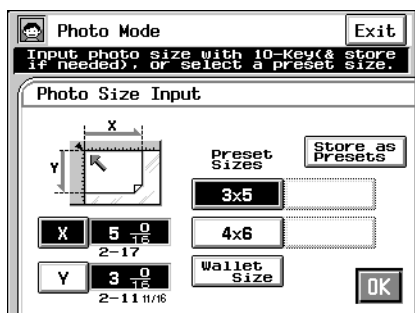

1179P219EA

- 2 Select the appropriate "Photo Type."

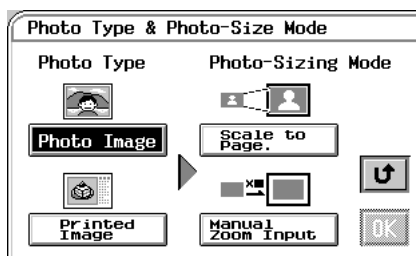

1179P198CA

- 3 Touch **Scale to Page** under the "Photo-Sizing Mode" and touch **OK**.

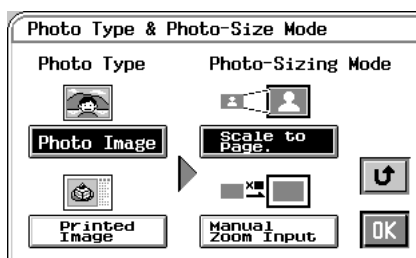

1179P199CA

<Using 10-Key Pad>

Touch **X** and enter the length of the photo from the 10-Key Pad. (If a value has already been set, press the Clear Key, then enter the new value.)

Next, touch **Y** and enter the width of the photo from the 10-Key Pad.

Useful Tip

A frequently used photo size can be stored in copier memory. p.3-37

- 4 Select the appropriate “Copy Size.”
(See Manual Bypass Copying. ☞ p.3-11)

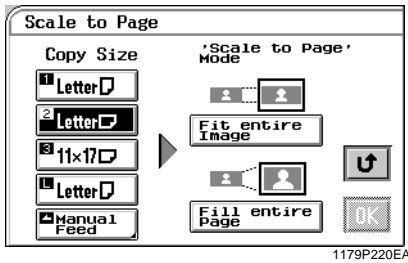

- 5 Select the appropriate “Scale to Page” Mode.

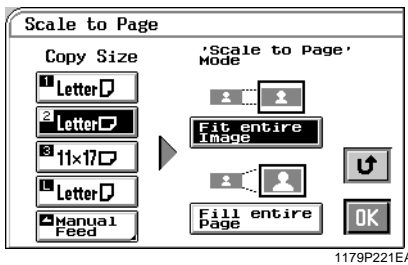

Useful Tips

- When **Fit Entire Image** is selected, the copier fits the entire image of the photo onto the copy paper.
- When **Fill Entire Page** is selected, the copier produces the image on the copy paper with a uniform margin along four edges

NOTE

Fill Entire Page may result in part of the image being lost on the copy.

- 6 Touch **OK**. The Touch Panel shows the settings made, prompting you to check them.

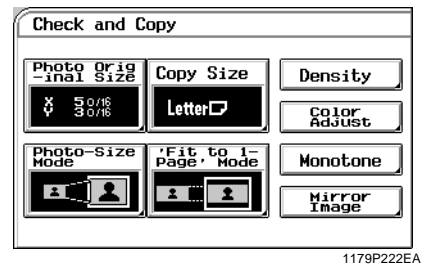

Useful Tips

- Touching the **Photo Original Size**, **Photo-Size Mode**, **Copy Size**, or **‘Fit to 1-Page’ Mode** key allows you to change the previous settings.
- Touch **Density** if you want to adjust the background level of the copy. ☞ p.3-17
- Touch **Color Adjust** if you want to make color adjustments. ☞ pp. 3-30, 4-11
- Touch **Monotone** if you want to make a single-color copy from a colored or black-and-white photo. ☞ p.4-17
- Touch **Mirror Image** if you want to make a copy whose image is identical to the original except reversed as viewed in a mirror. ☞ p.4-29

- 7 Place the original and press the Start Key. “Loading the Originals” ☞ p.3-6

- 8 Touch **Exit**.

Photo-Sizing Mode: Manual Zoom Input

1 Select the size of your photo and touch **OK**. If an appropriate size is not available, enter the size from the 10-Key Pad.

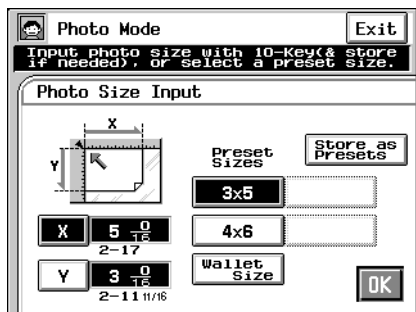

1179P219EA

<Using 10-Key Pad>

Touch **X** and enter the length of the photo from the 10-Key Pad. (If a value has already been set, press the Clear Key, then enter the new value.)

Next, touch **Y** and enter the width of the photo from the 10-Key Pad.

Useful Tip

A frequently used photo size can be stored in copier memory. *p.3-37*

2 Select the appropriate “Photo Type.”

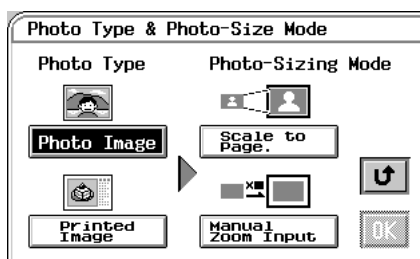

1179P198CA

3 Touch **Manual Zoom Input** under the “Photo-Sizing Mode” and touch **OK**.

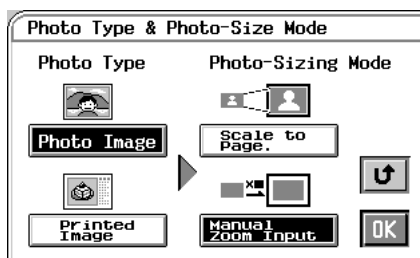

1179P203CA

4 Select the appropriate “Copy Size.” (See Manual Bypass Copying. *p.3-11*)

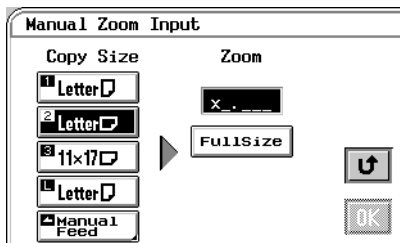

1179P223EA

5 Enter the desired zoom ratio from the 10-Key Pad. When **Full Size** is touched, you can make a full size copy.

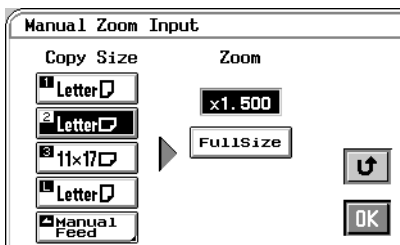

1179P224EA

6 Touch **OK**. The Touch Panel shows the settings made, prompting you to check them.

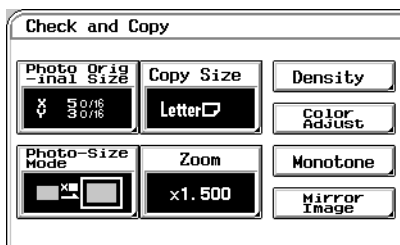

1179P225EA

Useful Tips

- Touching the **Photo Original Size**, **Photo-Size Mode**, **Copy Size**, or **Zoom** key allows you to change the previous settings.
 - Touch **Density** if you want to adjust the background level of the copy. ☞ p.3-17
 - Touch **Color Adjust** if you want to make color adjustments. ☞ p.3-30
 - Touch **Monotone** if you want to make a single-color copy from a colored or black-and-white photo. ☞ p.4-17
 - Touch **Mirror Image** if you want to make a copy whose image is identical to the original except reversed as viewed in a mirror. ☞ p.4-29
-

7 Place the original and press the Start Key. “Loading the Originals” ☞ p.3-3

8 Touch **Exit**.

Setting Mirror Image in Photo Mode

1 On the screen that prompts you to check the settings made in the Photo Mode, touch **Mirror Image**.

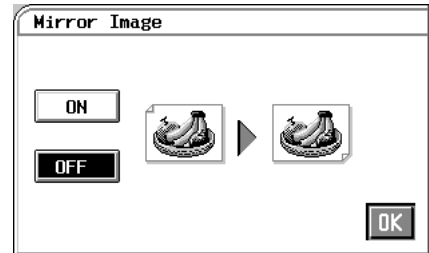

1179P207CA

2 Touch **ON**.

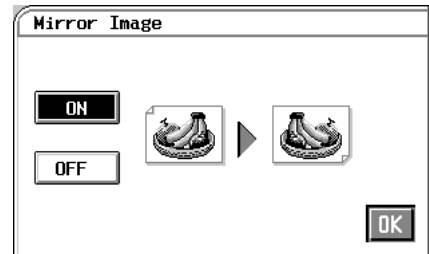

1179P208CA

3 Touch **OK**.

Storing the Photo Size in Memory

1 Touch **X** and enter the length of the photo from the 10-Key Pad. (If a value has already been set, press the Clear Key, then enter the new value.)

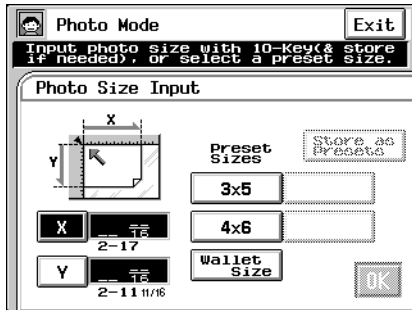

1179P218EA

2 Touch **Y** and enter the width of the photo from the 10-Key Pad.

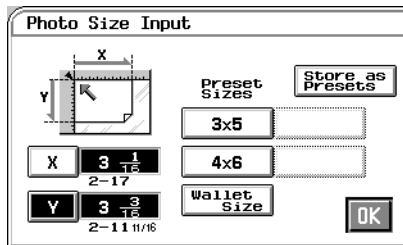

1179P226EA

3 Touch **Store as Presets**.

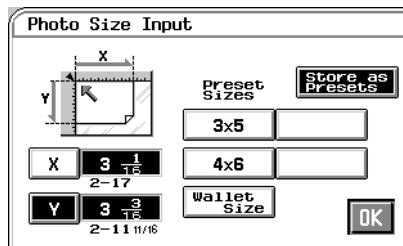

1179P227EA

4 Touch any of the non-labeled keys.

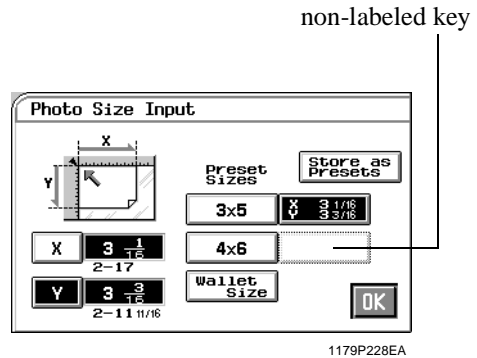

1179P228EA

NOTE

If you touch a key in which a size has previously been stored, the old data is erased.

5 Touch **OK**.

Chapter 4

Professional Way to Make Color Copies

1. Using the Applied Input ▶ Output Functions

This is an introduction to the four convenient features available in input ▶ output mode: Frame Erase, File Margin, Cover Sheet, and OHP.

When you touch **Input ▶ Output** on the Touch Panel, a screen appears that allows you to set the applied functions.

Select the finishing function (only when the copier is equipped with an optional Sorter or Staple Sorter). *p.3-25*

Make the input ▶ output settings for 2-sided and book copying. *p.3-19*

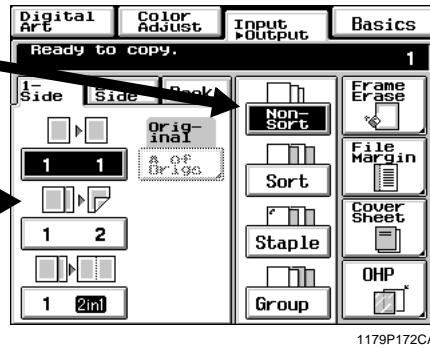

Applied function keys

* The contents of the display vary from system to system depending on which option or options are installed.

Frame Erase

The copier erases a margin of a set width along the four edges, one edge, or at the center to erase shadows or other unwanted images. This feature is effective in erasing the communications record on a document received by fax.

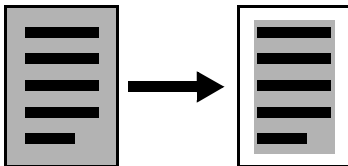

The copier provides a margin along the four edges on the copy.

Frame Erase Setting Procedure

<When the original is non-standard size>

1 Touch **Frame Erase**.

2 Touch **Custom Size**.

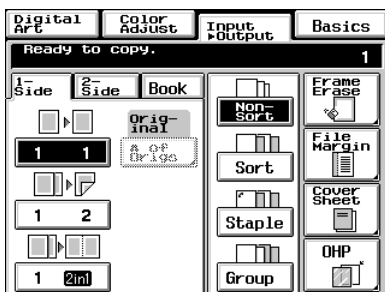

1179P172CA

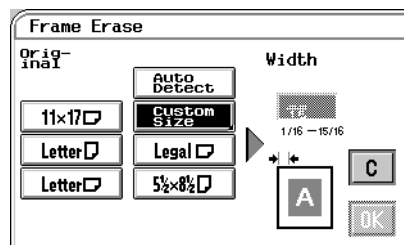

1179P305EA

- 3 Touch **X** and enter the length of the original from the 10-Key Pad. Then, touch **Y** and enter the width of the original.
(To correct a value entered, press the Clear Key.)

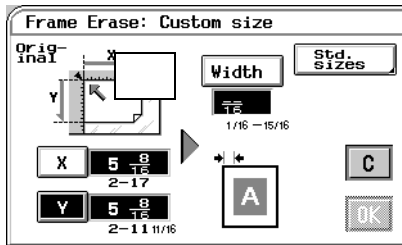

1179P306EA

- 4 Touch **Width** and enter the frame erase width from the 10-Key Pad.

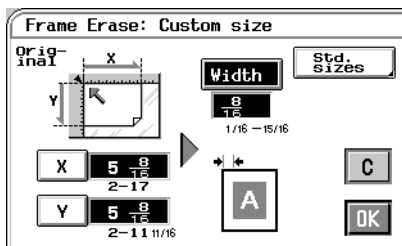

1179P307EA

- 5 Touch **OK**.

Useful Tips

- Touch **C** (cancel) to cancel the settings made for, and exit from, Frame Erase.
- This copier has been designed to have a lost image of a width of 8 mm on the leading edge, 4 mm on the trailing edge, and 3 mm each on the front and rear edges in the full size mode. Set a frame erase “Width” wider than each of these values to have a frame erase effect at all.
- A shadow can at times be produced along the edges when you make an 12×18 inch copy. We recommend that Frame Erase be used in such cases.

<When the original is standard size>

- 1 Touch **Frame Erase**.

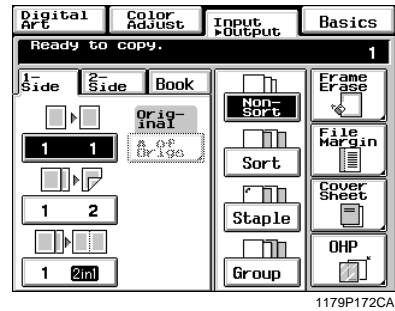

1179P172CA

- 2 Select the applicable “Original Size.”
Touch the exact size key or **Auto Detect**.

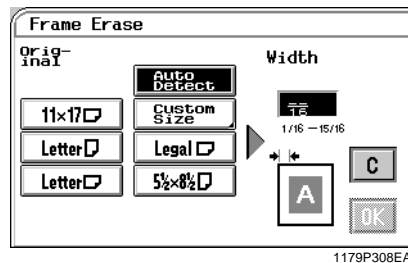

1179P308EA

- 3 Enter the frame erase “Width” from the 10-key Pad.

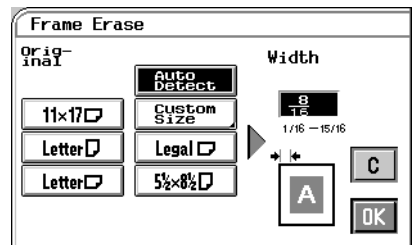

1179P309EA

- 4 Touch **OK**.

Useful Tips

- Touch **C** (cancel) to cancel the settings made for, and exit from, Frame Erase.
- This copier has been designed to have a lost image of a width of 8 mm on the leading edge, 4 mm on the trailing edge, and 3 mm each on the front and rear edges in the full size mode. Set a frame erase “Width” wider than each of these values to have a frame erase effect at all.
- A shadow can at times be produced along the edges when you make an 12×18 inch copy. We recommend that Frame Erase be used in such cases.

File Margin

The copier provides a file margin along the leading edge for your ease in filing.

There are four different ways available for making a file margin. Use the one that is most suited to your need.

Functions

Shift-for-Margin

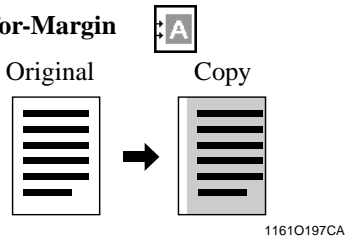

The image of the original is shifted to the right to make a margin along the left edge of the copy.

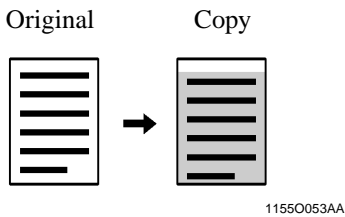

The image of the original is shifted to the bottom to make a margin along the top edge of the copy.

Margin-by-Reduction

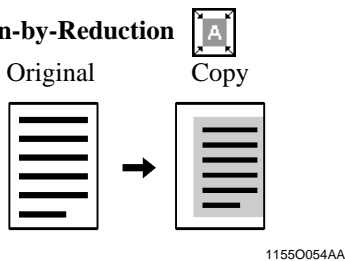

The image of the original which has almost no file margins along the sides is reduced to make a wider margin along the left edge of the copy.

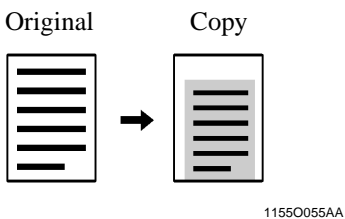

The image of the original which has almost no file margins along the sides is reduced to make a wider margin along the top edge of the copy.

Useful Tip

If the image of the original covers the entire surface of the original, Margin-by-Reduction will ensure a copy with no lost image along the edges.

File Margin Setting Procedure

- 1 Touch **File Margin**.

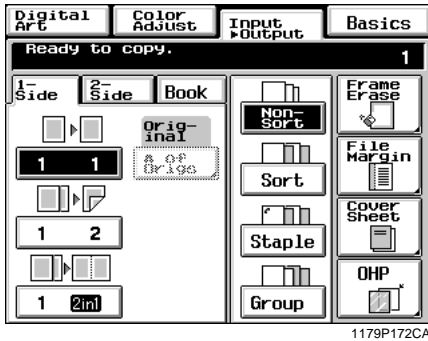

- 2 Place the original on the Original Glass or in the Duplexing Document Feeder.

NOTE

Make sure to correctly place the original in either portrait or landscape orientation.

- 3 Select the applicable “Original Position.”

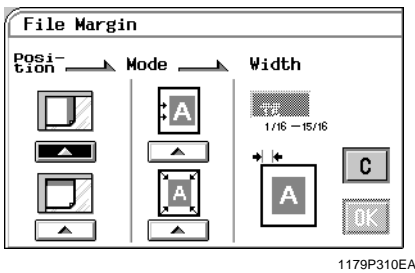

- 4 Select the applicable “File Margin Mode.”

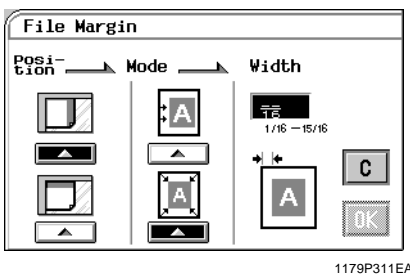

- 5 Enter the “File Margin Width” from the 10-Key Pad.

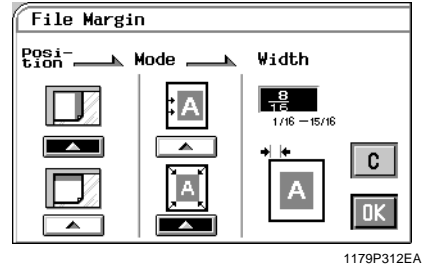

- 6 Touch **OK**.

NOTE

If the margin width is set larger than necessary in Shift-for-Margin, a void image can occur. Try to keep a good margin.

Useful Tip

Touch **C** (cancel) to cancel the settings made for, and exit from, File Margin.

1. Using the Applied Input ▶ Output Functions

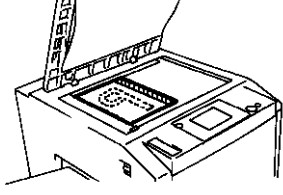
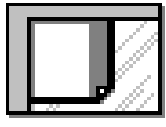
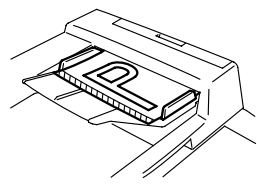
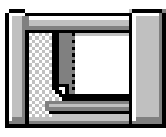
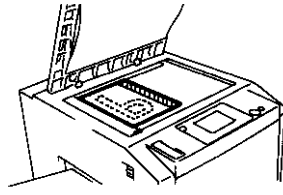
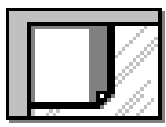
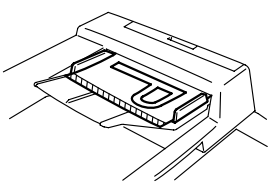
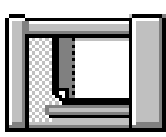
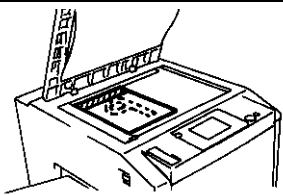
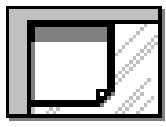
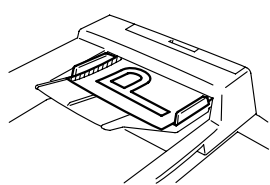
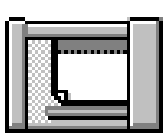
	Original Placement	Key to be Selected
Margin on Left Edge	 <p>1179O052AA</p>	 <p>1154P135AA</p>
	 <p>1154O004AA</p>	 <p>1154P137AA</p>
Margin on Right Edge	 <p>1179O053AA</p>	 <p>1154P135AA</p>
	 <p>1154O005AA</p>	 <p>1154P137AA</p>
Margin on Top Edge	 <p>1179O074AA</p>	 <p>1154P136AA</p>
	 <p>1154O006AA</p>	 <p>1154P138AA</p>

OHP Interleaving

When you make copies on OHP films, the OHP Interleaving function inserts copied or non-copied interleaves after each transparency. Two different functions are available. Select the appropriate one according to your need.

Functions

Single Copy

The copier copies onto OHP films and, after each film, inserts a copied or non-copied (blank) sheet of paper.

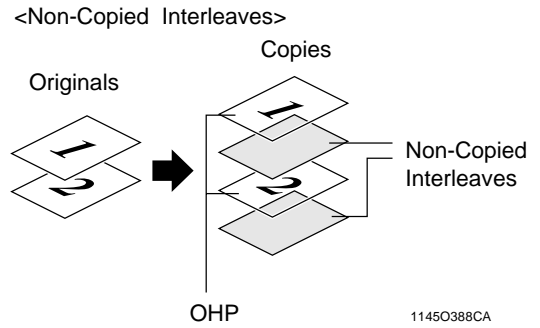
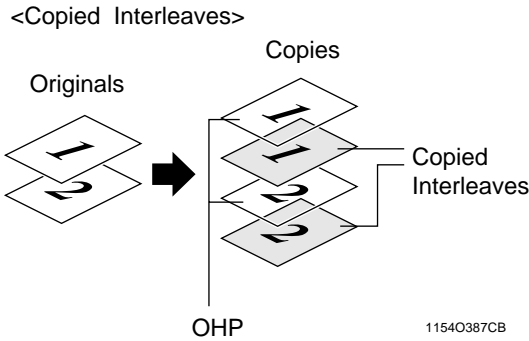

OHP Setting Procedure

- 1 Place the original on the Original Glass or in the Duplexing Document Feeder.

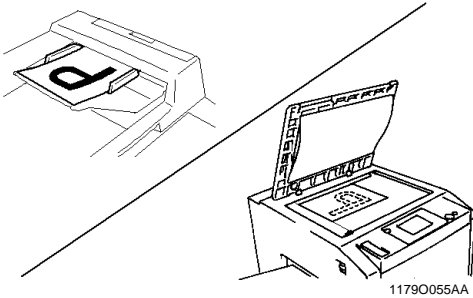

- 2 Touch **OHP**.

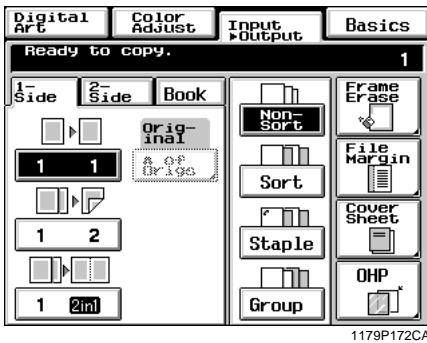

- 3 Place the OHP films on the Manual Bypass Tray. The side and edge on which white line has been printed, should be face up and towards the bypass port.

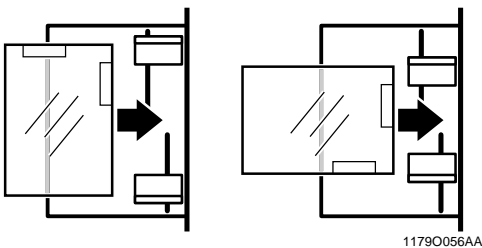

- 4 Select the size of the OHP films loaded in the Manual Bypass Tray.

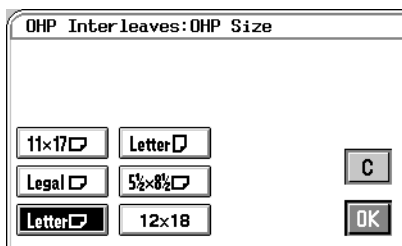

- 5 Touch **OK**.

- 6 Select the Tray in which the interleaves are loaded and touch **OK**.

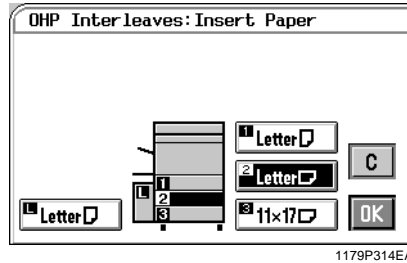

NOTES

- If you make copies from an original set, one page after another, via the Original Glass, make them in descending page order.
- If you want to use a Sorter or Staple Sorter for the copy run, remove the copy (OHP films) as soon as it is fed into the bin. If it is left in the bin for a while, it can curl.

- 7 Select whether you want to copy on the interleaves (Yes) or not (No) at “Copy onto Inserts.”

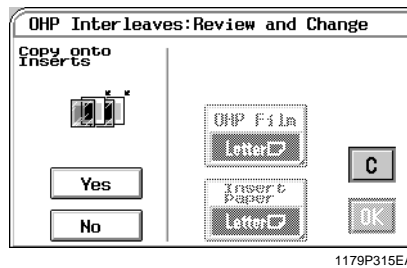

- 8 Touch **OK**.

Useful Tips

- Touching the **OHP Film** key allows you to change the previous settings.
- Touch **C** (cancel) to cancel the settings made for, and exit from, OHP.

Cover Sheet

The Cover mode lets you make a front cover, or a front and back cover, for a copy set. Cover Mode copies the first page, or the first and last page, of an original set on different paper from the normal copy paper, such as colored paper. There are six different Cover functions available. Select the appropriate one according to your need.

This function can be used only when the Duplexing Document Feeder is mounted.

Functions

Front Cover: Copied
Back Cover: None

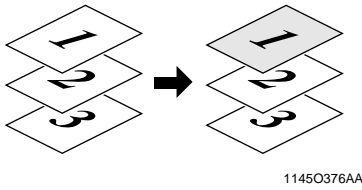

Front Cover: Blank
Back Cover: None

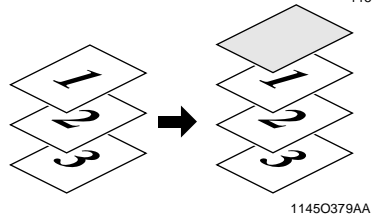

Front Cover: Copied
Back Cover: Blank

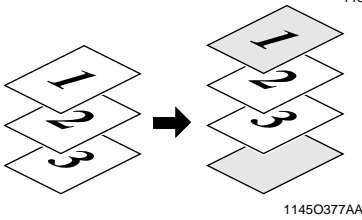

Front Cover: Blank
Back Cover: Blank

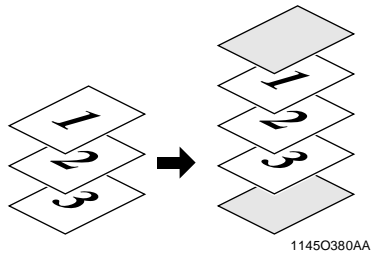

Front Cover: Copied
Back Cover: Copied

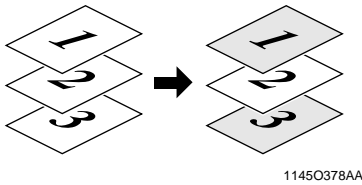

Front Cover: Blank
Back Cover: Copied

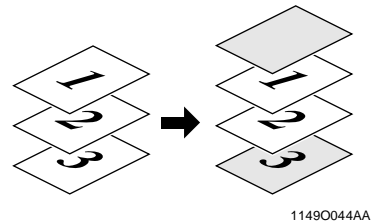

Cover Sheet Setting Procedure

- 1 Load your originals in the Duplexing Document Feeder.

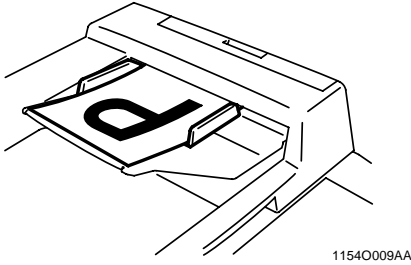

- 2 Touch **Cover Sheet**.

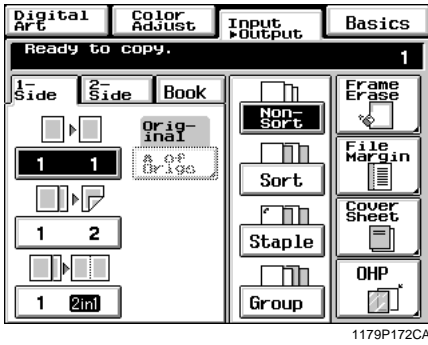

- 3 Place the copy paper for the cover sheet on the Manual Bypass Tray.

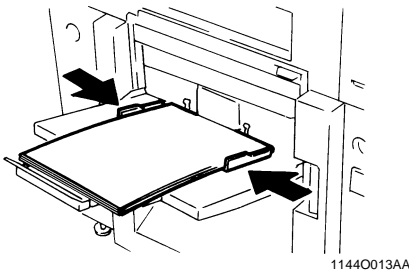

- 4 Make the necessary settings for the copy paper loaded in the Manual Bypass Tray: Size, Type, and 2nd Side for Dup. Manual Bypass Copying. (p.3-11)

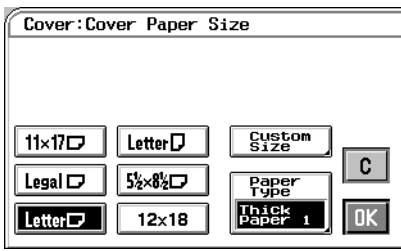

- 5 Touch **OK**.
- 6 Select the copy paper and touch **OK**.

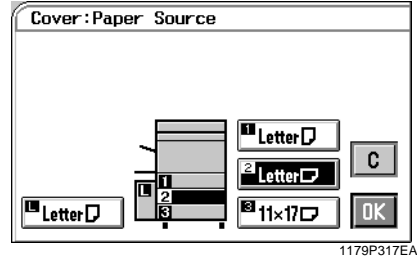

- 7 Select a particular function for "Front."

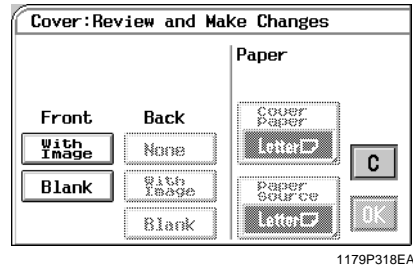

- 8 Select a particular function for "Back."

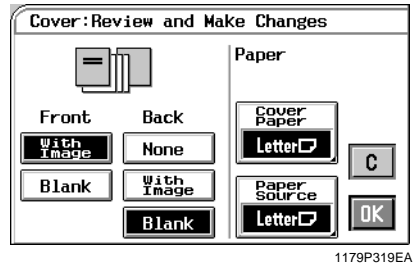

- 9 Touch **OK**.

Useful Tips

- Touching the **Cover Paper** or **Paper Source** key allows you to change the previous settings.
- Touch **C** (cancel) to cancel the settings made for, and exit from, Cover Sheet.

2. Color Adjust Mode (Professional)

These pages explain how to professionally adjust the hue or tone of the color produced on the copy.

When you touch **Color Adjust** on the Touch Panel, a screen appears that allows you to adjust these features.

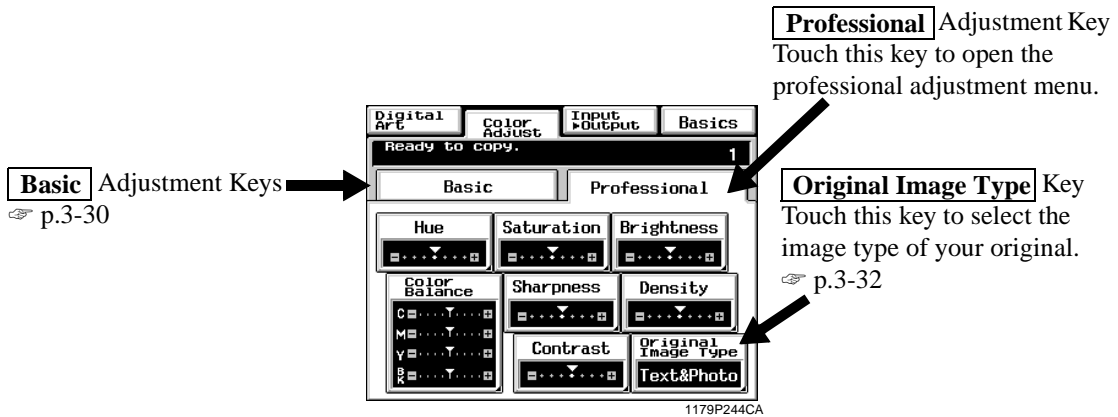

For copy samples, see the “Creative Image Book” separately provided.

Professional Adjustment Items

Hue

You can select one of seven samples, each having a specific hue level, to obtain the best possible hue on the copy. You can further fine-tune the hue level over 19 steps.

Saturation

You can select one of seven samples, each having a specific saturation level, to obtain the best possible saturation on the copy. You can further fine-tune the saturation level over 19 steps.

Brightness

You can select one of seven samples, each having a specific brightness level, to obtain the best possible brightness on the copy. You can further fine-tune the brightness level over 19 steps.

Sharpness

You can select one of seven samples, each having a specific sharpness level, to obtain the best possible sharpness on the copy.

Contrast

You can select one of seven samples, each having a specific contrast level, to obtain the best possible contrast on the copy. You can further fine-tune the contrast level over 19 steps.

Color Balance

You can adjust the balance of cyan, magenta, yellow, and black in the range between 0% and 200% in 1% increments.

Density

You can select one of seven samples, each having a specific density level, to obtain the best possible density on the copy. You can further fine-tune the density level over 19 steps.

Color Adjust Procedure (Professional: Other Than Color Balance)

- 1 Touch **Professional** and select the item for adjustment.

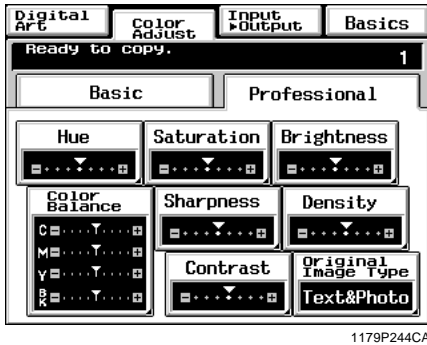

- 2 Touch **Test Print**.
(Ex.: When "Hue" is selected)

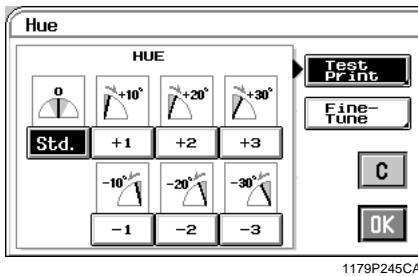

- 3 Position the image area of the original you want to check for color in the Test Area on the Glass.

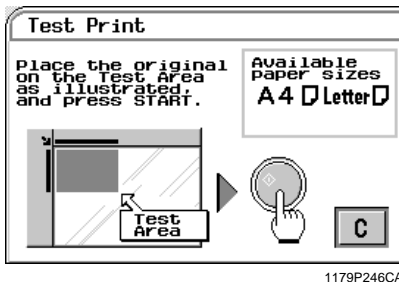

- 4 Press the Start Key. This causes the copier to output a sample copy showing seven images, each representing a different level of adjustment for the selected item.

- 5 Select the sample you like best, then touch **OK**.

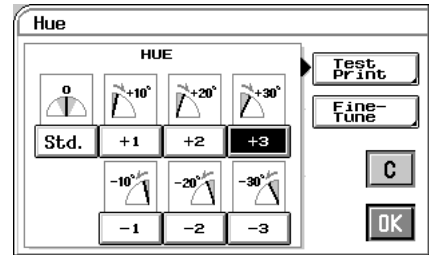

If you would like something in-between (e.g., a hue level between +2 and +3), touch **Fine-Tune**. Then, touch **+** or **-** as necessary to fine-tune the level.

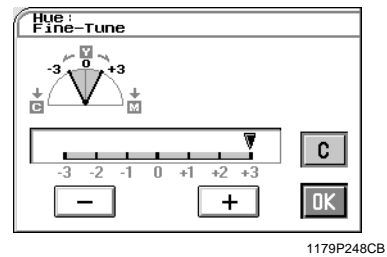

NOTE

"Sharpness" does not permit fine-tuning.

- 6 Place the original in position again and press the Start Key.

NOTE

The size of paper should be A4C or LetterC for test print.

2. Color Adjust Mode (Professional)

Color Adjust Procedure (Color Balance)

- 1 Touch **Professional** and touch **Color Balance**.



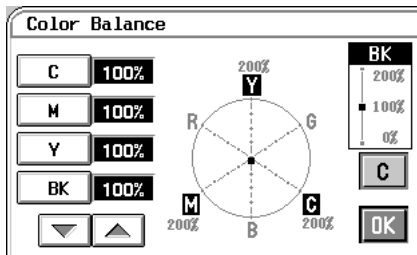

1179P244CA

- 2 Select the color you want to adjust for balance from among C (cyan), M (magenta), Y (yellow), and BK (black).



1179P249CA

- 3 Touch the  or  key to change the value as necessary.

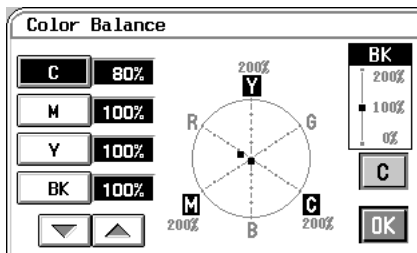

1179P250CA

- 4 Adjust the balance of another color if necessary and touch **OK**.

3. Using the Digital Art Functions

These pages explain about how to make settings for the various Digital Art functions the copier offers, including such ones as making a copy in a specified color and with a colored background.

When you touch **Digital Art**, a screen appears that allows you to make settings for the Digital Art Functions.

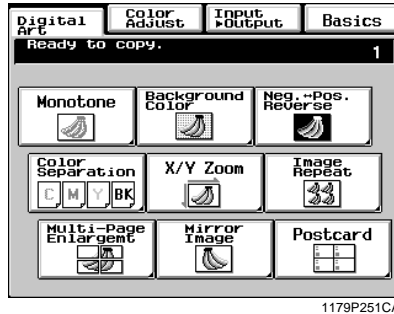

For copy samples, see the “Creative Image Book” separately provided.

Digital Art Functions List

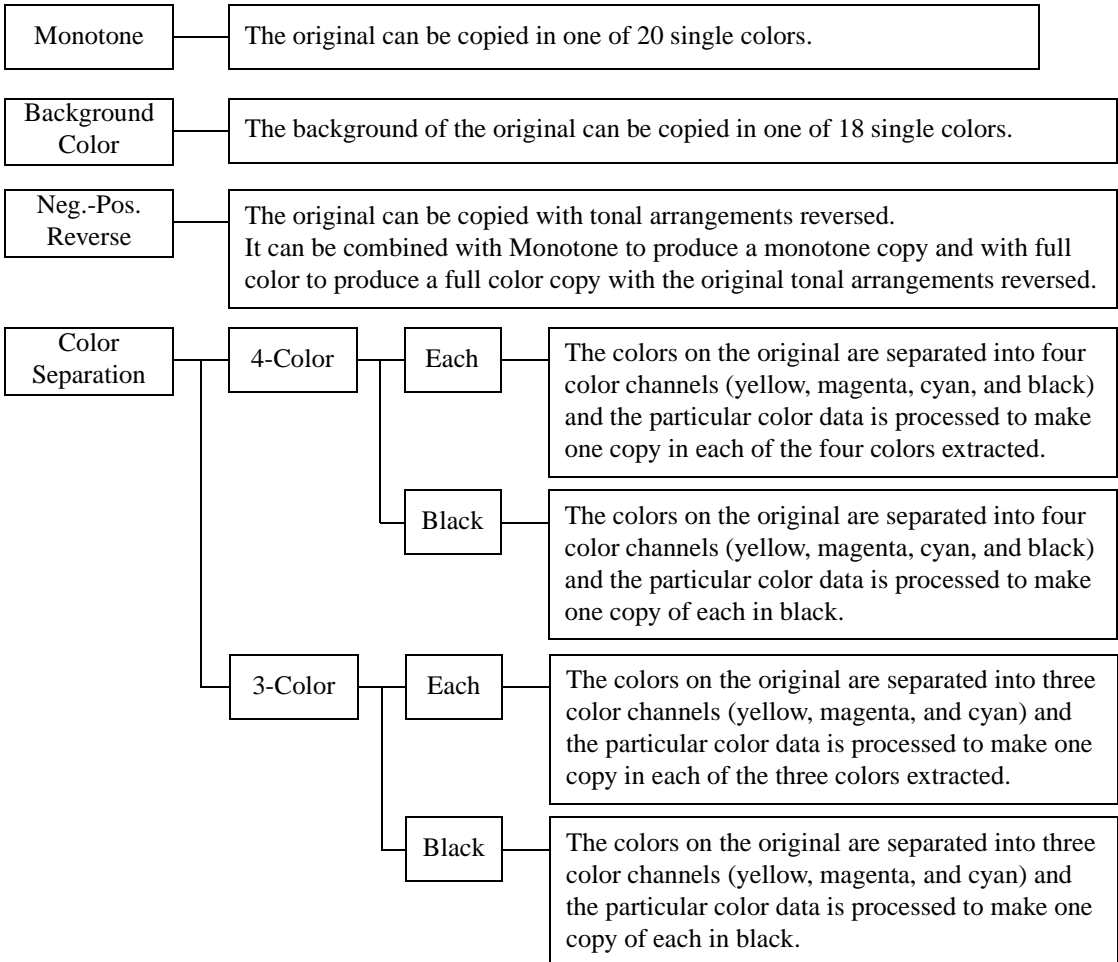

X/Y Zoom	The zoom ratio for the X (horizontal) and Y (vertical) directions can be set independently.
Image Repeat	The entire image on the original can be repeatedly copied onto a single copy at a desired zoom ratio.
Multi-Page Enlargement	The original is automatically divided into multiple parts, each being copied onto a separate sheet of paper. The function is used when you want to enlarge your original to a size larger than 11×17 inch. The copy size may be defined by either of the three ways: using a standard size, specifying a zoom ratio, or entering a custom size.
Mirror Image	An image, identical to the original except reversed, as if viewed in a mirror, is produced.
Postcard	Four identically sized (postcard) images of the original can be produced on a single Letter size copy.

3. Using the Digital Art Functions

Monotone

The original can be copied in any one of 20 single colors.

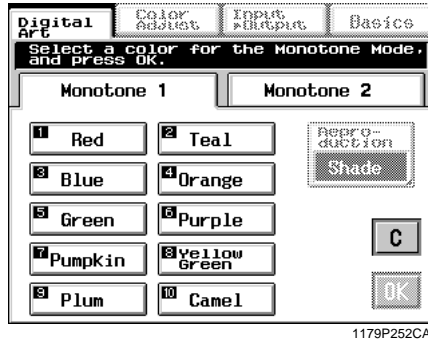

For copy samples and the output produced from each color specified on-screen, see the “Creative Image Book” separately provided.

Monotone Setting Procedure

- 1 Touch **Monotone** on the Digital Art menu screen.

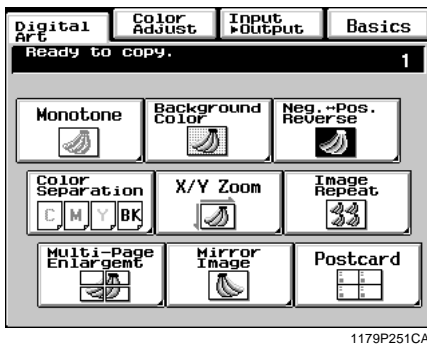

- 2 Select the color. You may need to touch **Monotone 2** to reach the color of your choice.

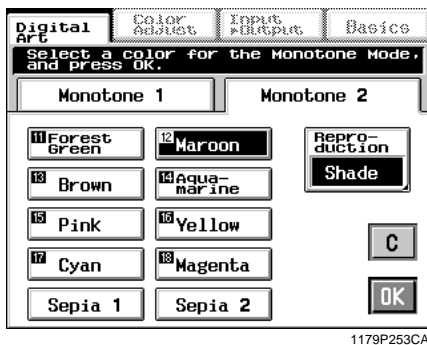

- 3 Touch **Reproduction** and select **Shade** or **Solid** as necessary. (**Shade** is selected in the initial mode.)

Shade: Shade will reproduce the colors in the original relative to the brightness of each color. Therefore, red will appear lighter than black. Shade will convert the original colors to different gradations of monotone. This mode would be excellent for reproducing photographs.

Solid: Solid will convert the original colors to the same density of monotone. This copy will have a much smaller tonal range than the Shade option. This mode would be suited for Line Art drawings or for text.

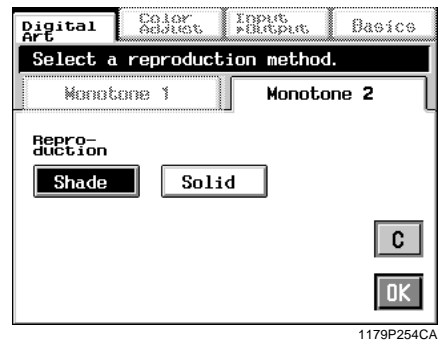

- 4 Touch **OK**.

Useful Tip

Touch **C** (cancel) to cancel the settings made for, and exit from, Monotone.

Background Color

The background of the original can be copied in any one of 18 single colors.

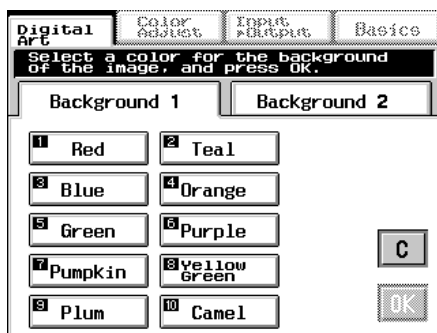

1179P255CA

For copy samples and the output produced from each color specified on-screen, see the “Creative Image Book” separately provided.

Background Color Setting Procedure

- 1 Touch **Background Color** on the Digital Art menu screen.

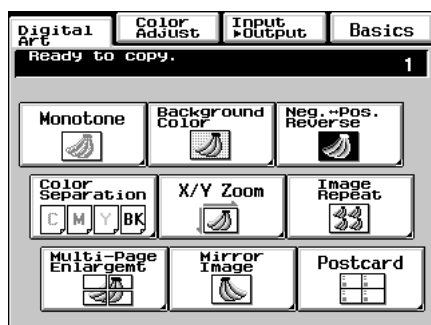

1179P251CA

- 2 Select the color you want to use as the background color.
Touch **Background 2** as necessary to reach the color of your choice.

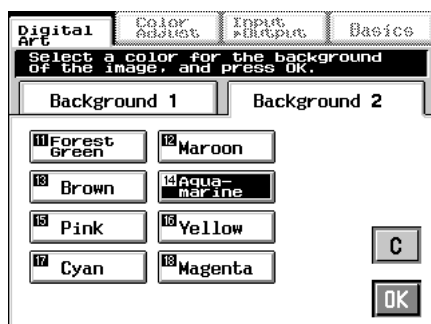

1179P256CA

- 3 Touch **OK**.

Useful Tip

Touch **C** (cancel) to cancel the settings made for, and exit from, Background Color.

NOTES

- This function is valid only when the background of the original is white.
- All white areas of the original are regarded as the background and copied in the specified color.
- The entire tone of colors may change if you use a colored original.

3. Using the Digital Art Functions

Neg.-Pos. Reverse

The original can be copied with the original tonal arrangements reversed.

It can be combined with Monotone to produce a monotone copy and with full color to produce a full color copy with reversed tonal arrangements.

For copy samples, see the “Creative Image Book” separately provided.

Neg.-Pos. Reverse Setting Procedure

- 1 Touch **Neg.-Pos. Reverse** on the Digital Art menu screen.



1179P251CA

- 2 Touch **ON**.

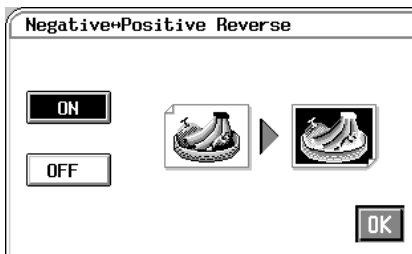

1179P257CA

Useful Tip

Touch **OFF** to cancel the settings made for, and exit from, Neg.-Pos. Reverse.

Color Separation

The colors on the original are separated into four color channels (yellow, magenta, cyan, and black) or three color channels (yellow, magenta, and cyan) and the particular color data is processed to make one copy in each of the colors extracted. The particular color data is also processed to make one copy of each in black.

For copy samples, see the “Creative Image Book” separately provided.

Color Separation Setting Procedure

- 1 Touch **Color Separation** on the Digital Art menu screen.



1179P251CA

- 2 Select either **4-Color** or **3-Color**.

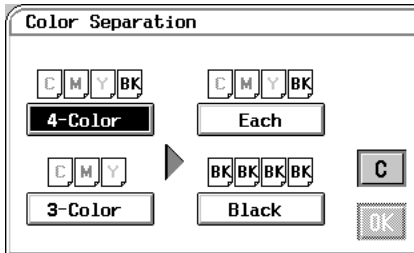

1179P258CA

- 3 Select either **Each** or **Black**.

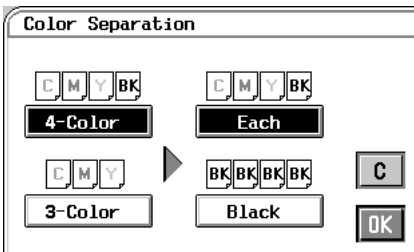

1179P259CA

- 4 Touch **OK**.

Useful Tip

Touch **C** (cancel) to cancel the settings made for, and exit from, Color Separation.

3. Using the Digital Art Functions

X/Y Zoom

The zoom ratio for the X (horizontal) and Y (vertical) directions can be set independently. For the setting procedure, you have a choice of **Zoom Ratio (%)**, with which you enter the X/Y zoom ratios from the 10-Key Pad, or **Output Size**, with which you enter the sizes of the original and copy paper from the 10-Key Pad.

For copy samples, see the “Creative Image Book” separately provided.

X/Y Zoom Setting Procedure

<When **Zoom Ratio** is selected>

- 1 Touch **X/Y Zoom** on the Digital Art menu screen.

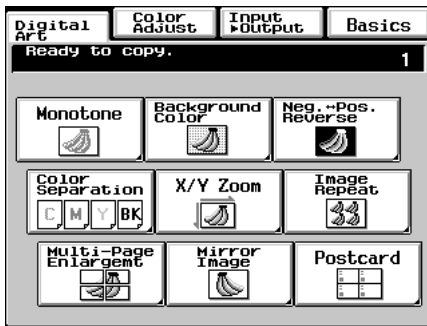

1179P251CA

- 2 Select **Zoom Ratio** and then touch **OK**.



1179P260CA

- 3 Touch **X** and enter the zoom ratio in the length direction from the 10-Key Pad.
Touch **Y** and enter the zoom ratio in the width direction from the 10-Key Pad.

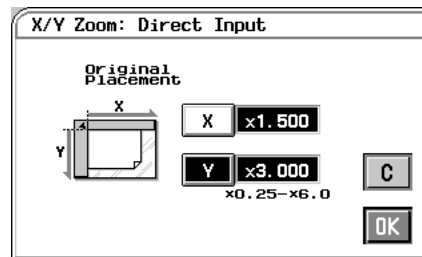

1179P261CA

- 4 Touch **OK**.

Useful Tip

Touch **C** (cancel) to cancel the settings made for, and exit from, X/Y Zoom.

NOTE

To correct a value entered, press the Clear Key.

3. Using the Digital Art Functions

<When [Output Size] is selected>

- 1 Touch **X/Y Zoom**.



1179P251CA

- 2 Select **Output Size** and then touch **OK**.



1179P262CA

- 3 Touch **X** under “Original” and enter the length of the original from the 10-Key Pad. Touch **Y** under “Original” and enter the width of the original from the 10-Key Pad.

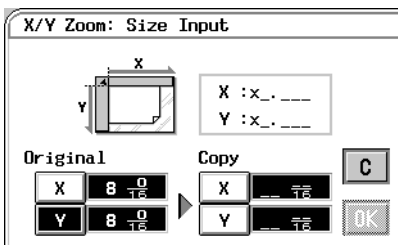

1179P320EA

- 4 Touch **X** under “Copy” and enter the length of the copy paper from the 10-Key Pad. Touch **Y** under “Copy” and enter the width of the copy paper from the 10-Key Pad.

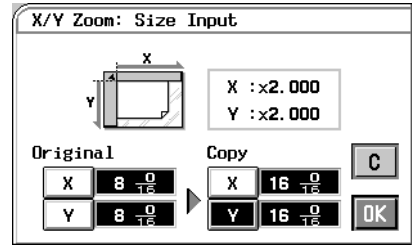

1179P321EA

- 5 Touch **OK**.

Useful Tip

Touch **C** (cancel) to cancel the settings made for, and exit from, X/Y Zoom.

NOTE

For **Output Size**, you cannot enter a length or width which results in a zoom ratio falling outside the $\times 0.250$ -to- $\times 6.000$ range.

Image Repeat

The entire image on the original can be repeatedly copied on a single copy at a desired zoom ratio.

For copy samples, see the “Creative Image Book” separately provided.

Image Repeat Setting Procedure

- 1 Touch **Image Repeat** on the Digital Art menu screen.
- 2 Select your “Original Size” and touch **OK**.
 - Touch **Custom Size** if your original is a non-standard size.
 - Touch **Photo Size** if your original is a photo size.

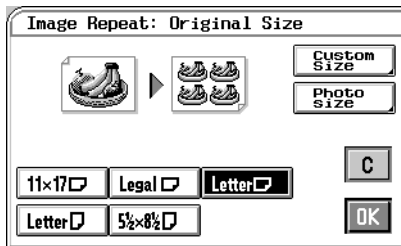

1179P322EA

- 3 Select a copy paper size and touch **OK**.

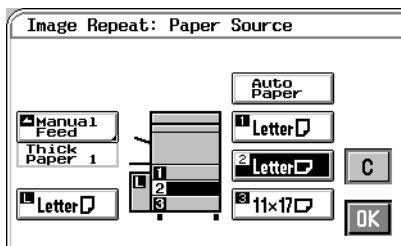

1179P323EB

- 4 Touch **Zoom** and set the zoom ratio from the 10-Key Pad.

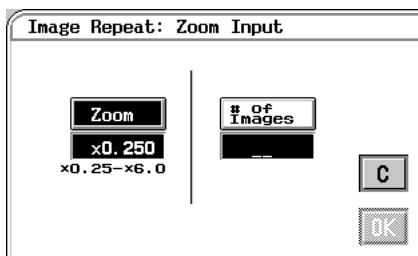

1179P267CA

- 5 Touch **# of Images** and, from the 10-Key Pad, enter the number of images you want.

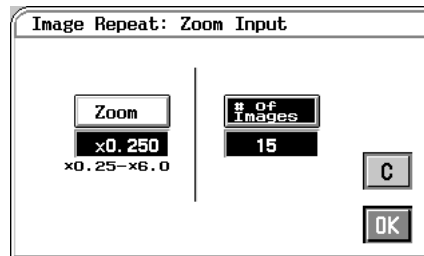

1179P268CA

- 6 Touch **OK**. Then, the “Check and Change” screen appears allowing you to check and change any incorrect settings you have made.

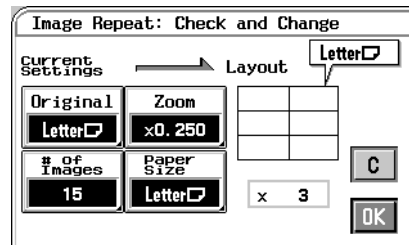

1179P324EA

Useful Tip

Touching the **Original**, **Zoom**, **# of Images**, or **Paper Size** key allows you to change the previous settings.

- 7 Touch **OK**.

Useful Tip

Touch **C** (cancel) to cancel the settings made for, and exit from, Image Repeat.

If the original is a non-standard size

Touch **Custom Size** on the screen given in step 2.



1179P348EA

Touch **X** and enter the length of the original from the 10-Key Pad. Then touch **Y** and enter the width of the original from the 10-Key Pad. (To correct a value entered, press the Clear Key.)

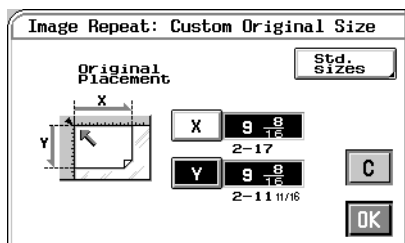

1179P325EA

Touch **OK**.

If the original is a photo size

Touch **Photo Size** on the screen given in step 2.

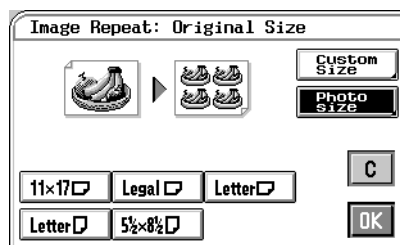

1179P349EA

Select the size of your photo and touch **OK**. If an appropriate size is not available, enter the size from the 10-Key Pad.

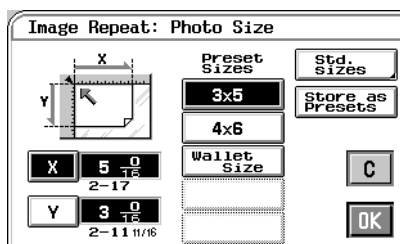

1179P326EA

<Using 10-Key Pad>

Touch **X** and enter the length of the photo from the 10-Key Pad. (If a value has already been set, press the Clear Key, then enter the new value.)

Next, touch **Y** and enter the width of the photo from the 10-Key Pad.

Useful Tip

A frequently used photo size can be stored in copier memory. ☞ p.3-37

Multi-Page Enlargement

The original is automatically divided into multiple parts, each being copied onto a separate sheet of paper. The function is used when you want to enlarge your original to a size larger than A3.

For the setting procedure, you have a choice of **Standard Size**, with which you select the copy size from among the standard sizes, **Zoom Ratio (%)**, with which you specify the zoom ratio manually, or **Custom Size**, with which you need to enter the size of the copy from the 10-Key Pad.

For copy samples, see the “Creative Image Book” separately provided.

Multi-Page Enlargement Setting Procedure

<When **Standard Size** is selected>

1 Touch **Multi-Page Enlargement** on the Digital Art menu screen.

2 Select your “Original Size.” Touch **OK**.

- Touch **Custom Size** if the original is a non-standard size. ☞ p.4-28
- Touch **Photo Size** if your original is a photo size. ☞ p.4-28

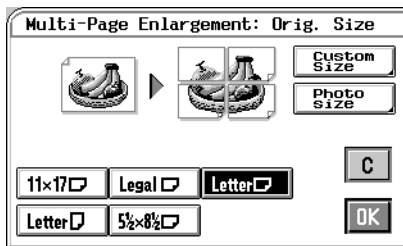

1179P327EA

3 Select a copy paper size and touch **OK**.

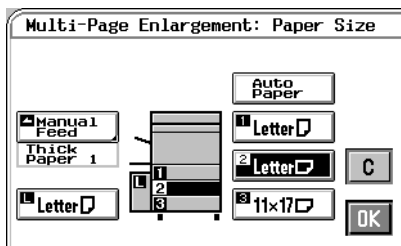

1179P330EB

4 Touch **Standard Size** and touch **OK**.

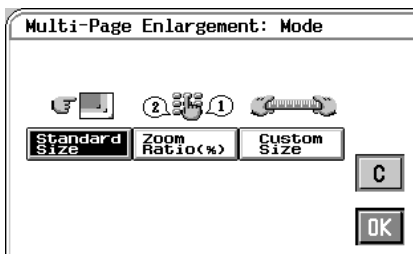

1179P273CA

5 Select the copy paper size.

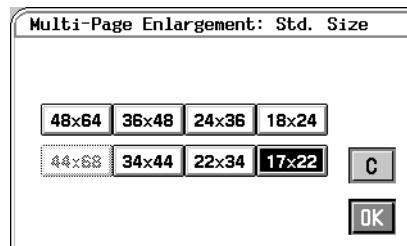

1179P328EA

6 When **OK** is touched, the “Check/Change” screen appears allowing you to check and change any incorrect settings you have made.

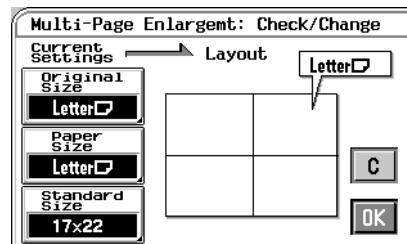

1179P329EA

Useful Tip

Touching the **Original Size**, **Paper Size**, or **Standard Size** key allows you to change the previous settings.

7 Touch **OK**.

Useful Tip

Touch **C** (cancel) to cancel the settings made for, and exit from, Multi-Page Enlargement.

<When **Zoom Ratio** is selected>

- 1 Touch **Multi-Page Enlargement** on the Digital Art menu screen.

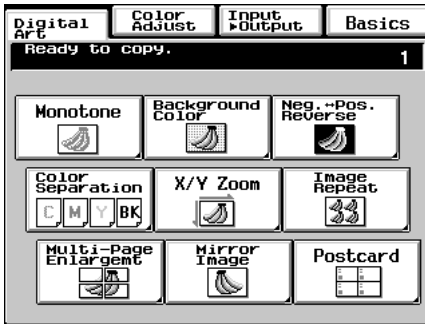

1179P251CA

- 2 Select your "Original Size." Touch **OK**.
- Touch **Custom Size** if the original is a non-standard size. ☞ p.4-28
 - Touch **Photo Size** if your original is a photo size. ☞ p.4-28

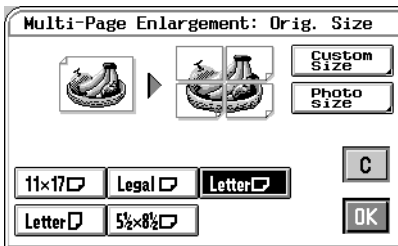

1179P327EA

- 3 Select a copy paper size and touch **OK**.

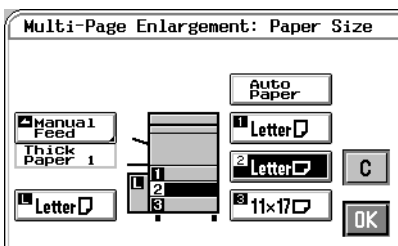

1179P330EB

- 4 Touch **Zoom Ratio** and touch **OK**.

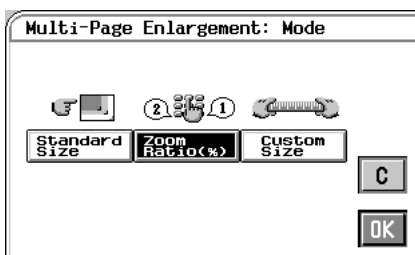

1179P277CA

- 5 Enter the zoom ratio from the 10-Key Pad.

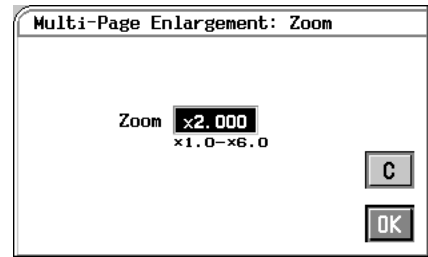

1179P278CA

- 6 When **OK** is touched, the "Check/Change" screen appears allowing you to check and change any incorrect settings you have made.

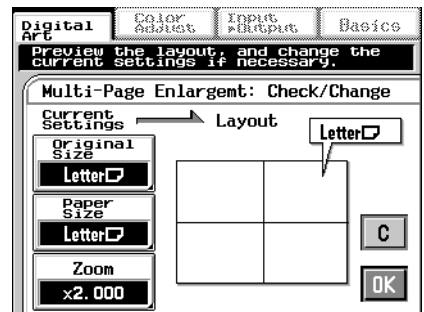

1179P331EA

Useful Tip

Touching the **Original Size**, **Paper Size**, or **Zoom** key allows you to change the previous settings.

- 7 Touch **OK**.

Useful Tip

Touch **C** (cancel) to cancel the settings made for, and exit from, Multi-Page Enlargement.

3. Using the Digital Art Functions

<When **Custom Size** is selected>

1 Touch **Multi-Page Enlargement** on the Digital Art menu screen.

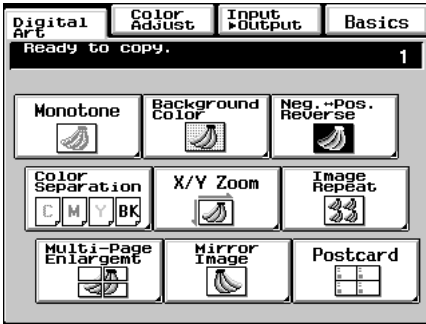

1179P251CA

2 Select your "Original Size." Touch **OK**.

- Touch **Custom Size** if the original is a non-standard size. (p.4-28)
- Touch **Photo Size** if your original is a photo size. (p.4-28)

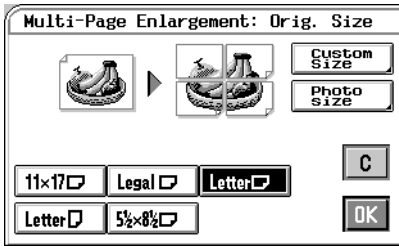

1179P327EA

3 Select a copy paper size and touch **OK**.

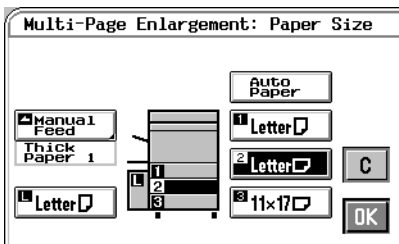

1179P330EB

4 Touch **Custom Size** and touch **OK**.

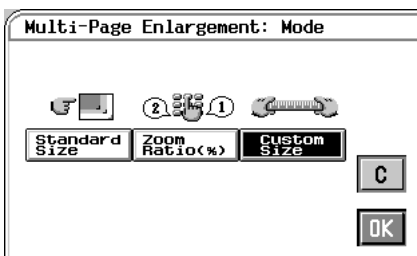

1179P280CA

5 Touch **X** and enter the length from the 10-Key Pad. Then, touch **Y** and enter the width from the 10-Key Pad. (To correct a value entered, press the Clear Key.)

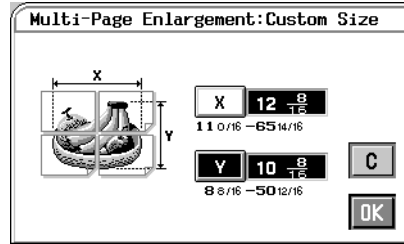

1179P332EA

6 When **OK** is touched, the "Check/Change" screen appears allowing you to check and change any incorrect settings you have made.

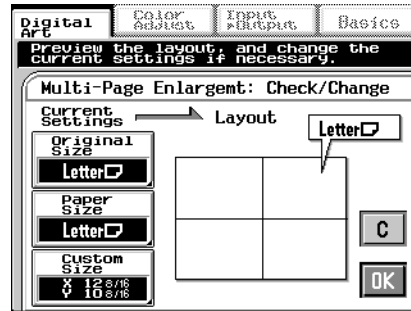

1179P333EA

Useful Tips

Touching the **Original Size**, **Paper Size**, or **Custom Size** key allows you to change the previous settings.

7 Touch **OK**.

Useful Tip

Touch **C** (cancel) to cancel the settings made for, and exit from, Multi-Page Enlargement.

If the original is a non-standard size

Touch **Custom Size** on the screen given in step 2.

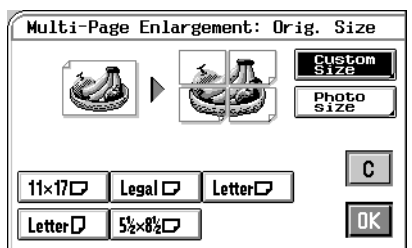

1179P350EA

Touch **X** and enter the length of the original from the 10-Key Pad. Then touch **Y** and enter the width of the original from the 10-Key Pad. (To correct a value entered, press the Clear Key.)

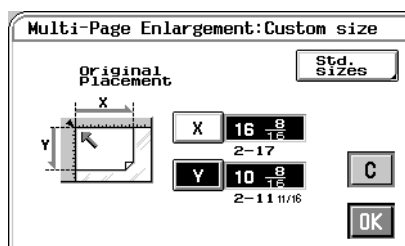

1179P334EA

Touch **OK**.

If the original is a photo size

Touch **Photo Size** on the screen given in step 2.

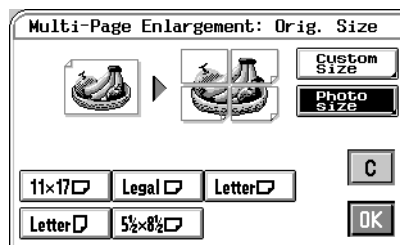

1179P351EA

Select the size of your photo and touch **OK**. If an appropriate size is not available, enter the size from the 10-Key Pad.

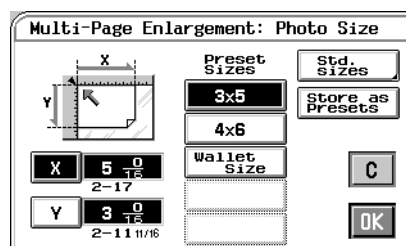

1179P335EA

<Using 10-Key Pad>

Touch **X** and enter the length of the photo from the 10-Key Pad. (If a value has already been set, press the Clear Key, then enter the new value.)

Next, touch **Y** and enter the width of the photo from the 10-Key Pad.

Useful Tip

A frequently used photo size can be stored in copier memory. p.3-37

3. Using the Digital Art Functions

Mirror Image

An image, identical to the original except reversed, as if viewed in a mirror, is produced.

For copy samples, see the “Creative Image Book” separately provided.

Mirror Image Setting Procedure

- 1 Touch **Mirror Image** on the Digital Art menu screen.



1179P251CA

- 2 Select the original size.
 - Touch **Custom Size** if the original is a non-standard size.
 - Touch **Photo Size** if the original is a photo size.

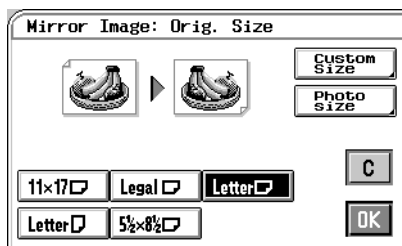

1179P336EA

- 3 Touch **OK**.

If the original is a non-standard size

Touch **Custom Size** on the screen given in step 2.

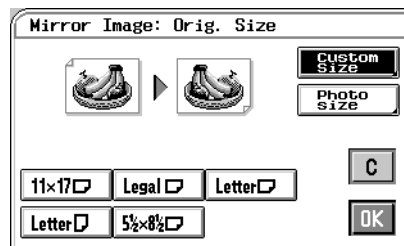

1179P352EA

Touch **X** and enter the length of the original from the 10-Key Pad. Then touch **Y** and enter the width of the original from the 10-Key Pad. (To correct a value entered, press a Clear Key.)

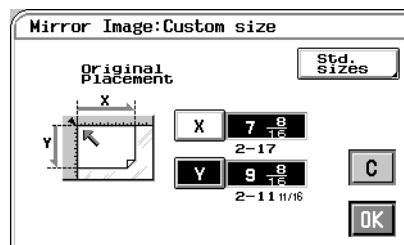

1179P337EA

Touch **OK**.

Useful Tip

Touch **C** (cancel) to cancel the settings made for, and exit from, Mirror Image.

If the original is a photo size

Touch **Photo Size** on the screen given in step 2.

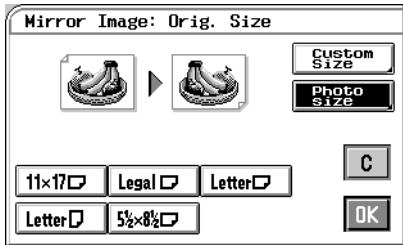

1179P353EA

Select the size of your photo and touch **OK**. If an appropriate size is not available, enter the size from the 10-Key Pad.

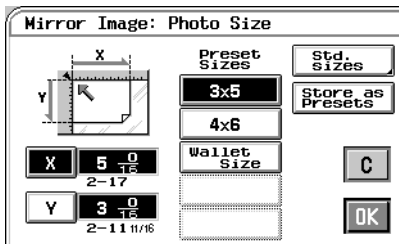

1179P338EA

<Using 10-Key Pad>

Touch **X** and enter the length of the photo from the 10-Key Pad. (If a value has already been set, press the Clear Key, then enter the new value.)

Next, touch **Y** and enter the width of the photo from the 10-Key Pad.

Useful Tip

A frequently used photo size can be stored in copier memory. p.3-37

Postcard

Four identically sized (postcard) images of the original can be produced on a single Letter Size copy. The original size may be selected from among the standard sizes. Or, Custom Size or Photo Size may be selected to enter the size manually. For copy samples, see the “Creative Image Book” separately provided.

Postcard Setting Procedure

<When the original is a standard size>

1 Touch **Postcard** on the Digital Art menu screen.

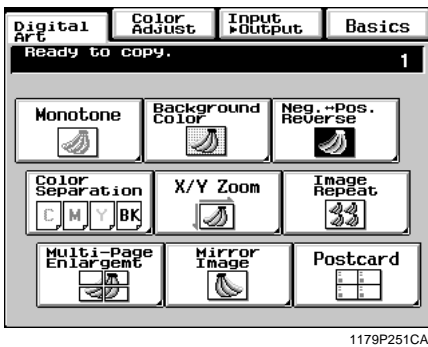

2 Select the size of your “Original.”

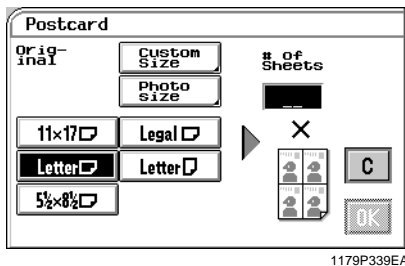

3 In the # of sheets box, enter the number of postcard sheets desired.

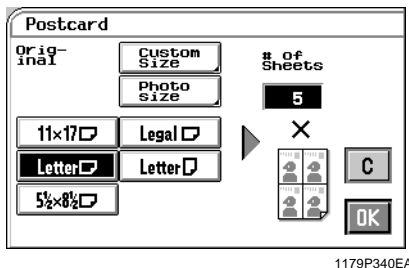

4 Touch **OK**.

5 Place your original and paper as shown on the Touch Panel and press the Start Key.

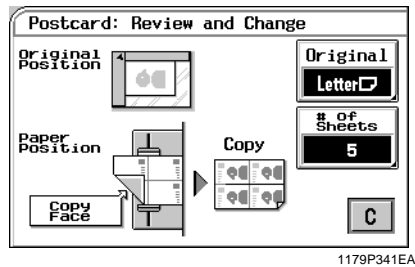

Useful Tips

- Touching the **Original** or **# of sheets** key allows you to change the previous settings.
- Touch **C** (cancel) to cancel the settings made for, and exit from, Postcard.
- For the copy paper for Postcard, consult the service shop you purchased your copier from.

Useful Tip

Enter 1 for 4 postcards and 2 for 8 postcards.

<When the original is a non-standard size>

- 1 Touch **Postcard** on the Digital Art menu screen.

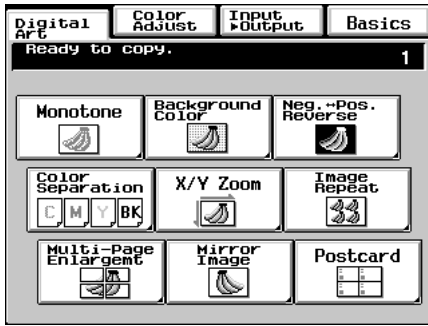

1179P251CA

- 2 Touch **Custom Size**.

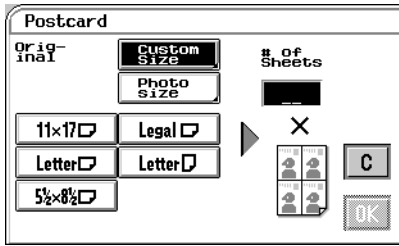

1179P354EA

- 3 Touch **X** and enter the length of the original from the 10-Key Pad. Then, touch **Y** and enter the width of the original. (To correct a value entered, press the Clear Key.)

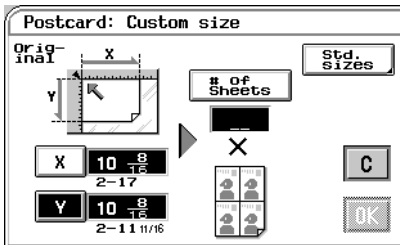

1179P342EA

- 4 Touch **# of Sheets** and enter the number of copies to be made from the 10-key Pad.

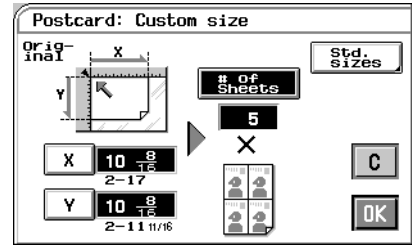

1179P343EA

Useful Tip

Enter 1 to make 4 postcards and 2 to make 8 postcards.

- 5 Touch **OK**.

- 6 Place your original and paper as shown on the Touch Panel and press the Start Key.

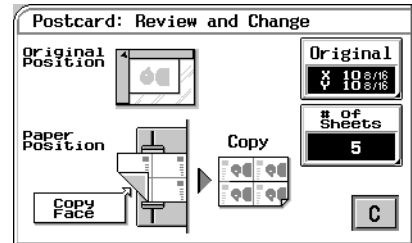

1179P344EA

Useful Tips

- Touching the **Original** or **# of sheets** key allows you to change the previous settings.
- Touch **C** (cancel) to cancel the settings made for, and exit from, Postcard.
- For the copy paper for Postcard, consult the service shop you purchased your copier from.

3. Using the Digital Art Functions

<When the original is a photo size>

- 1 Touch **Postcard** on the Digital Art menu screen.

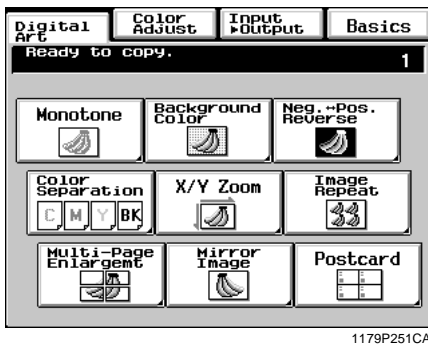

- 2 Touch **Photo Size**.

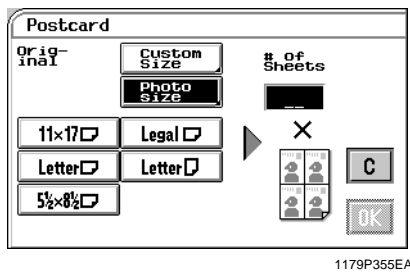

- 3 Select the size of your photo and touch **OK**. If an appropriate size is not available, enter the size from the 10-Key Pad.

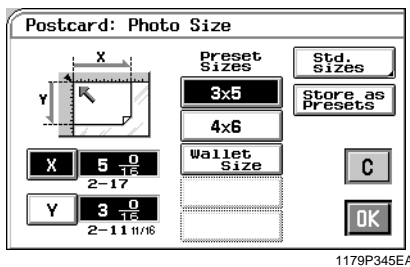

<Using 10-Key Pad>

Touch **X** and enter the length of the photo from the 10-Key Pad. (If a value has already been set, press the Clear Key, then enter the new value.)

Next, touch **Y** and enter the width of the photo from the 10-Key Pad.

Useful Tip

A frequently used photo size can be stored in copier memory. *p. 3-37*

- 4 In the # of sheets box, enter the number of postcard sheets desired.

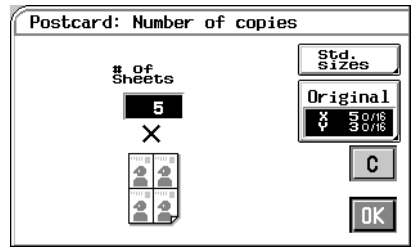

Useful Tip

Enter 1 for 4 postcards and 2 for 8 postcards.

- 5 Touch **OK**.

- 6 Place your original and paper as shown on the Touch Panel and press the Start Key.

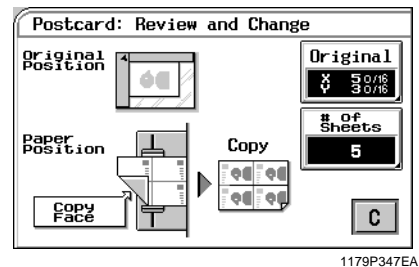

Useful Tips

- Touching the **Original** or **# of sheets** key allows you to change the previous settings.
- Touch **C** (cancel) to cancel the settings made for, and exit from, Postcard.
- For the copy paper for Postcard, consult the service shop you purchased your copier from.

Chapter 5

Setting the Utility Mode

1. Default Settings

The Default Settings refer to the copying function settings established when the copier is turned ON or the Panel Reset key is pressed. The Utility mode lets you change the default settings.

Default Settings Changing Procedure

1 Press the Utility key.

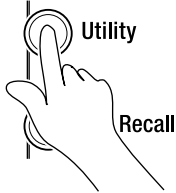

1179O010CB

2 Touch **Default Settings**.

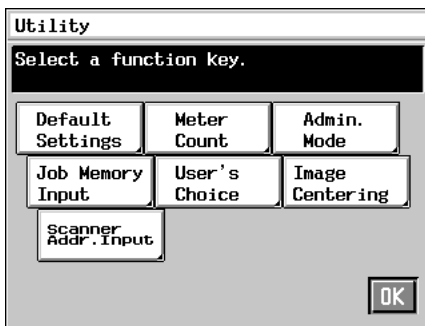

1179P356CA

3 Select either **Current Settings** or **Factory Settings**.

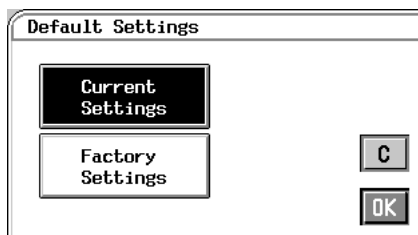

1179P357CA

4 Touch **OK**.

Useful Tips

- When you select **Current Settings**, the settings made on the control panel are the default settings.
- When you select **Factory Settings**, the settings made in the factory become the default settings.

2. Meter Count

This function allows you to check the cumulative number of copies produced since the installation of your copier.

Calling up Meter Count

- 1 Press the Utility key.

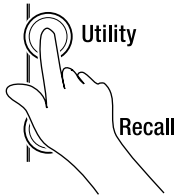

11790010CB

- 2 Touch **Meter Count**.

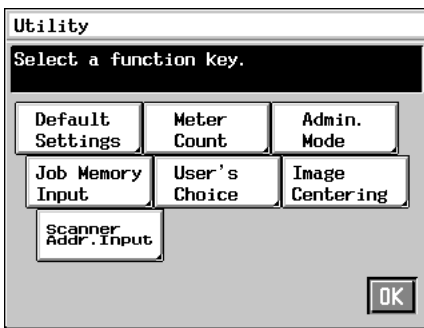

1179P356CA

- 3 The Touch Panel shows the count data for the copies made in full color and in black.

	Full Color & Black	Monotone	
	Full Color	Black	Duplex
Copy	0	0	0
Large	0	0	
Print	0	0	
(C+P)	G. Total	0	OK

1179P358CA

- 4 When **Monotone** is touched, the panel shows the count data for the copies made in monotone.

	Full Color & Black	Monotone
	C/M/Y	3C Mono Tone
Copy	0	0
Large	0	0
Print	0	0
(C+P)	G. Total	0

1179P359CA

- 5 When you have checked the count data, touch **OK**.

Glossary of Touch Panel Terms:

- Total: Total number of copies made for all copy paper sizes.
- Large: Number of copies made on large copy paper of a preset size. (The size will be set by your Technical Representative.)
- Print: Number of prints made through a controller by a computer.
- Full Color: Number of copies made in the full color mode.
- Black: Number of copies made in the black mode.
- Duplex: Number of 2-sided copies made using the Duplex Unit.
- C/M/Y: Number of copies made in cyan, magenta, or yellow in the monotone mode.
- 3C Monotone: Number of copies made in a color other than cyan, magenta, and yellow in the monotone mode.

Printing the Meter Count Data

- To print the Meter Count data, place Letter  paper on the Manual Bypass Tray and press the Start key.

3. Copy Track Functions

This function is intended for the person who controls and manages the copier.

The numbers of copies made by up to 100 different accounts can be controlled by defining a unique access number for each account.

Setting the Copy Track Functions

- 1 Press the Utility key and touch **Admin. Mode**.

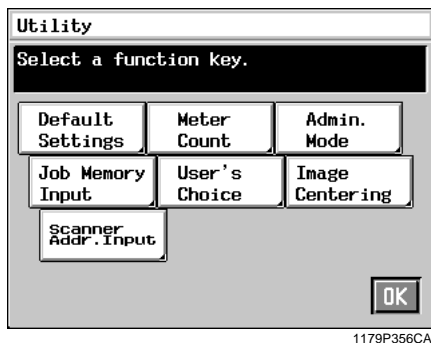

- 2 Enter your administrator code number from the 10-Key Pad, then touch **OK**.

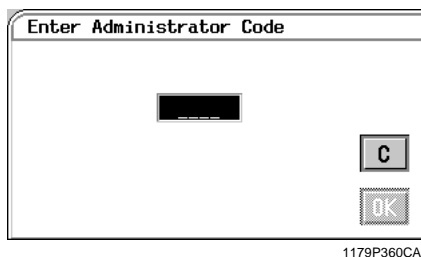

NOTES

- Your Technical Representative sets or changes the administrator code number. Consult him or her for more details.
- Be sure to remember your administrator code number.

- 3 Touch **Copy Track Functions**.

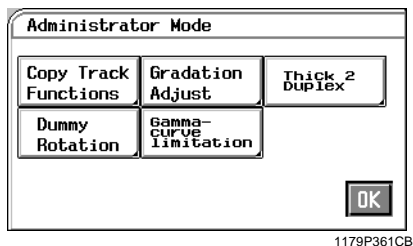

- 4 Touch **ON** or **OFF** to activate or deactivate the Copy Track Functions.

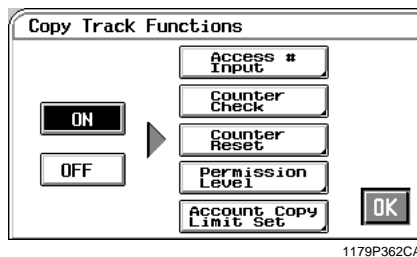

NOTE

If **ON** is selected, program an access number for each account.

If **OFF** is selected, touch **YES** to reset the Copy Track Functions Data.

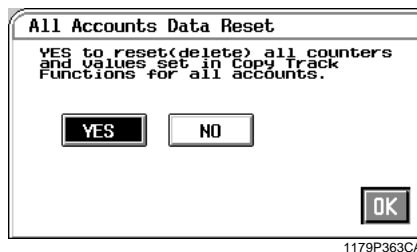

- 5 Touch **OK**.

Changing the Account Number

- 1 Press the Utility Key and touch **Admin. Mode**.

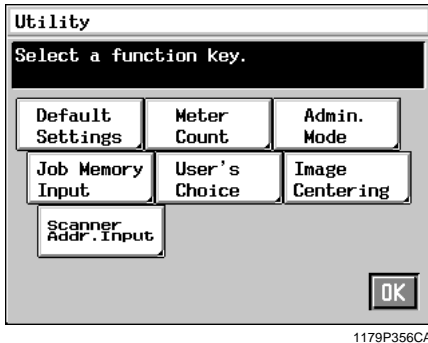

- 2 Enter your administrator code number from the 10-Key Pad, then touch **OK**.

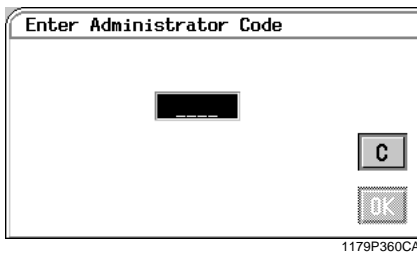

NOTES

- Your Technical Representative sets or changes the administrator code number. Consult him or her for more details.
- Be sure to remember your administrator code number.

- 3 Touch **Copy Track Functions**.

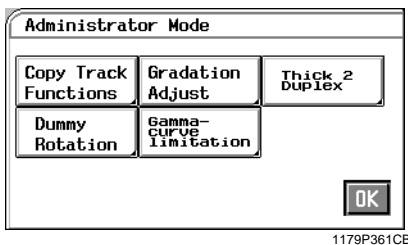

- 4 Touch **Access # Input**.

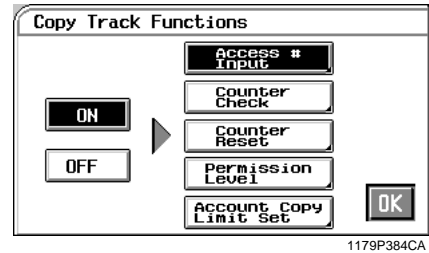

NOTE

If **OFF** has been selected, the **Access # Input** key cannot be selected.

- 5 Touch **Account #** and then using the **▼** or **▲** key select the account number which you want to change.

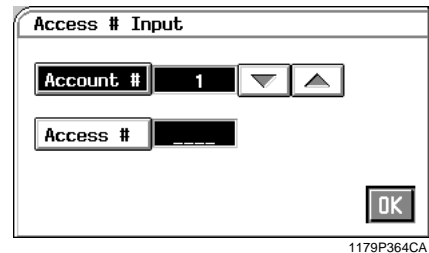

- 6 Press the Clear Key and enter the desired account number (up to 3-digits) from the 10-Key Pad and touch **OK**.

NOTES

- An account number cannot be duplicated.
- If you want to change the account number for another account, repeat steps 4 to 6.

Programming the Access Numbers

- 1 Press the Utility Key and touch **Admin. Mode**.

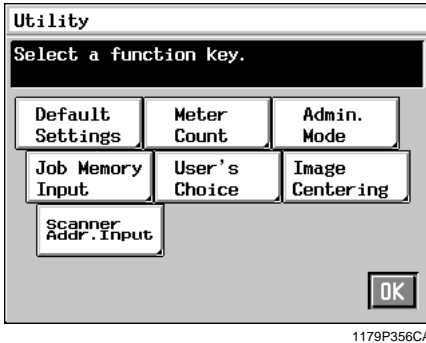

- 2 Enter your administrator code number from the 10-Key Pad, then touch **OK**.

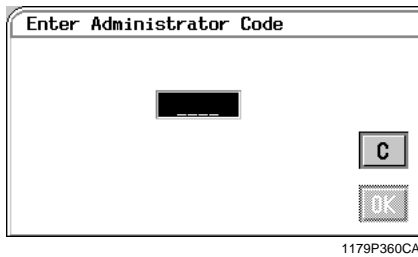

NOTES

- Your Technical Representative sets or changes the administrator code number. Consult him or her for more details.
- Be sure to remember your administrator code number.

- 3 Touch **Copy Track Functions**.

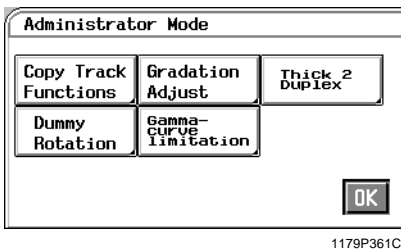

- 4 Touch **Access # Input**.

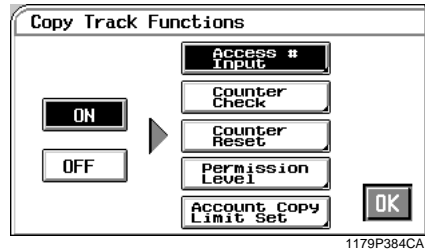

NOTE

If **OFF** has been selected, the **Access # Input** key cannot be selected.

- 5 Touch **Access #** and then using the **▼** or **▲** key select the account number for which you want to program an access number.

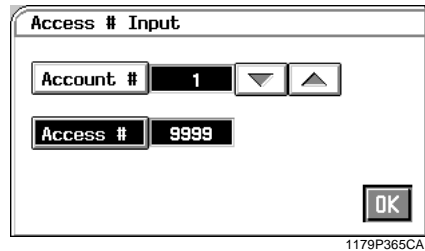

- 6 Enter the desired 4-digit access number from the 10-Key Pad and touch **OK**.

NOTES

- If you set a new access number for an account which already has an access number, the old number will be erased.
- If an access number entered already exists, it is canceled. Please enter a new number again.
- If you want to program an access number for another account, repeat steps 4 to 6.

Checking the Number of Copies Made by Each Account

- 1 Press the Utility Key and touch **Admin. Mode**.

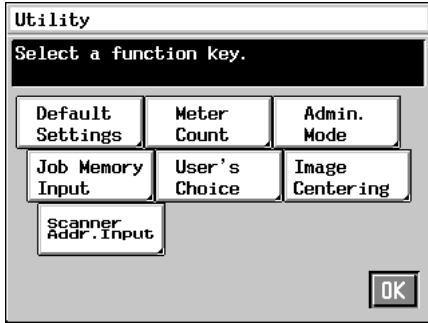

1179P356CA

- 2 Enter your administrator code number from the 10-Key Pad, then touch **OK**.

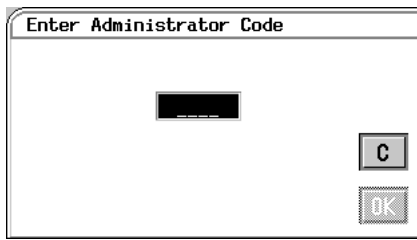

1179P360CA

NOTES

- Your Technical Representative sets or changes the administrator code number. Consult him or her for more details.
- Be sure to remember your administrator code number.

- 3 Touch **Copy Track Functions**.

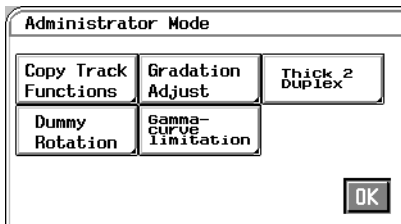

1179P361CB

- 4 Touch **Counter Check**.

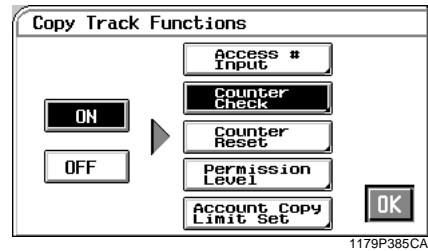

1179P385CA

- 5 Using the \blacktriangledown or \blacktriangle key, select the "Account #" for which you want to check the number of copies made.

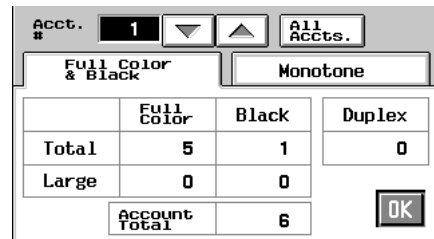

1179P366CA

Useful Tips

- If you touch **All Accts.**, the display shows the total number of copies made by all accounts programmed.
- You can press the Start Key to let the copier print a tally sheet of the number of copies made.

- 6 Touch **OK**.

Resetting Counters

1 Press the Utility Key and touch **Admin. Mode**.

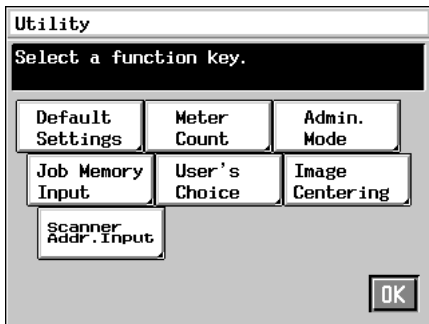

1179P356CA

2 Enter your administrator code number from the 10-Key Pad, then touch **OK**.

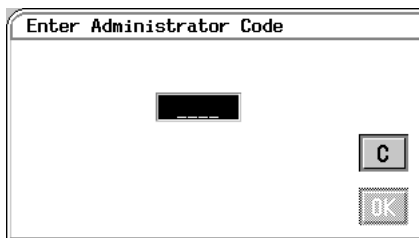

1179P360CA

NOTES

- Your Technical Representative sets or changes the administrator code number. Consult him or her for more details.
- Be sure to remember your administrator code number.

3 Touch **Copy Track Functions**.

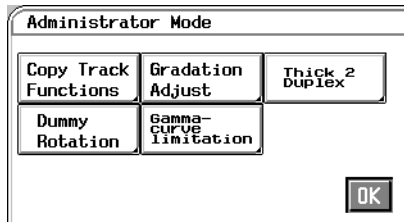

1179P361CB

4 Touch **Counter Reset**.

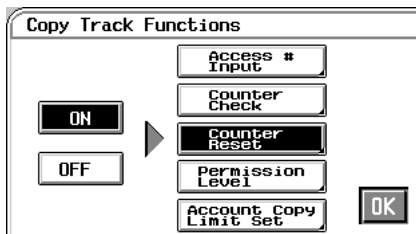

1179P386CA

5 Using the **▼** or **▲** key, select the "Account #" for which you want to reset the counter and touch **Cancel**.

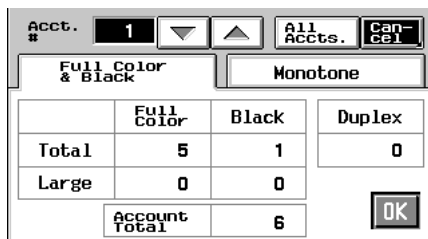

1179P367CA

Useful Tip

To clear the counters of all accounts at once, touch **All Accts**.

6 Touch **Yes** and touch **OK**.

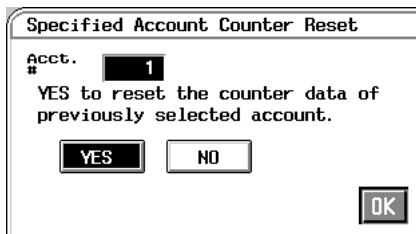

1179P386CA

Useful Tip

If you want to clear the counter of another account, repeat steps 5 and 6.

7 Touch **OK**.

Prohibiting Color Copying for Each Account

Either color copying or black copying can be prohibited for each account.

- 1 Press the Utility Key and touch **Admin. Mode**.

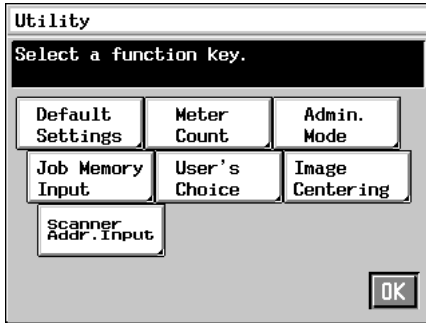

1179P356CA

- 2 Enter your administrator code number from the 10-Key Pad, then touch **OK**.



1179P360CA

NOTES

- Your Technical Representative sets or changes the administrator code number. Consult him or her for more details.
- Be sure to remember your administrator code number.

- 3 Touch **Copy Track Functions**.

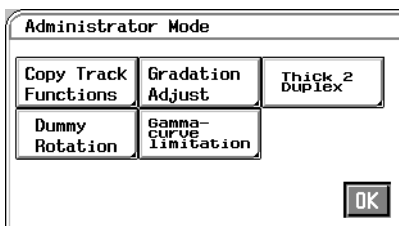

1179P361CB

- 4 Touch **Permission Level**.

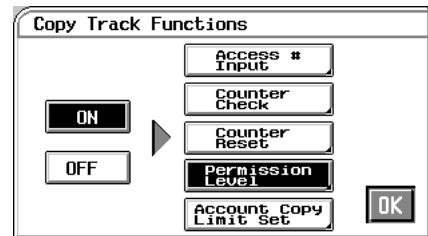

1179P387CA

- 5 Using the **▼** or **▲** key, select the "Account #" for which you want to prohibit copying.

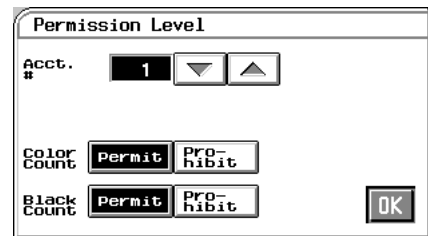

1179P369CA

- 6 Touch the **Prohibit** key of Color Count or Black Count, whichever is necessary.

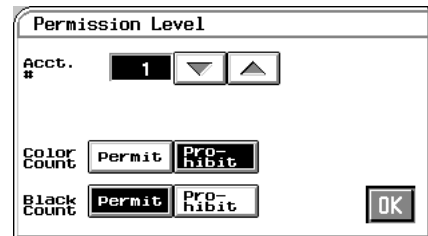

1179P370CA

Useful Tip

If you want to prohibit color copying or black copying for another account, repeat steps 5 and 6.

- 7 Touch **OK**.

Setting the Maximum Number of Copies to be Made by Each Account

It is possible for you to set the copy limit for color copying or black copying, or both, for each account.

1 Press the Utility key.

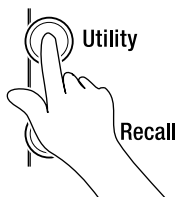

1179O010CB

2 Touch **Admin. Mode**.

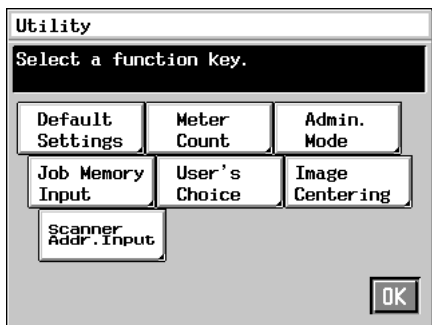

1179P356CA

3 Enter your administrator code number from the 10-Key Pad, then touch **OK**.



1179P360CA

4 Touch **Copy Track Functions**.

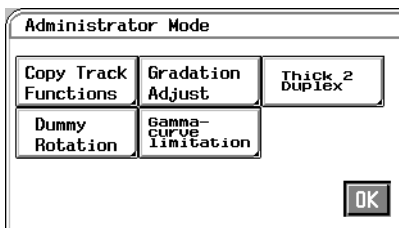

1179P361CB

5 Touch **Account Copy Limit Set**.

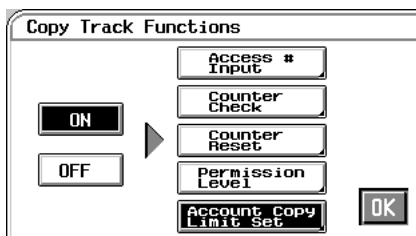

1179P388CA

6 Using **▼** or **▲**, select the "Account #" for which you want to set the maximum number of copies to be made.

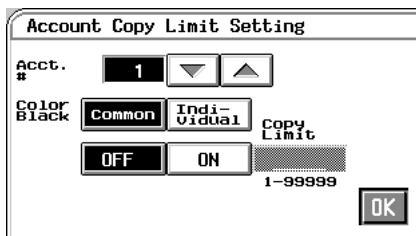

1179P371CA

7 Select **Common** (for both) or **Individual** for setting the color and black copy limits, then touch the **ON** key.

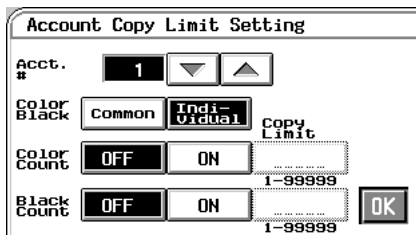

1179P372CA

NOTES

- Your Technical Representative sets or changes the administrator code number. Consult him or her for more details.
- Be sure to remember your administrator code number.

- 8 Touch the respective “Copy Limit” key and then enter the copy limit from the 10-Key Pad.

Account Copy Limit Setting

Acct. # 1

Color Black Common **Indi-Original** Copy Limit

Color Count OFF ON **12345** 1-99999

Black Count OFF ON OK 1-99999

1179P373CA

Useful Tip

If you want to set a Copy Limit for another account, repeat steps 6 to 8.

- 9 Touch **OK**.

4. Gradation Adjust

Carry out a Gradation Adjust sequence if the copier fails to reproduce color or the reproduced color becomes foggy as you make a number of color copies.

Gradation Adjust Sequence

- 1 Press the Utility key.

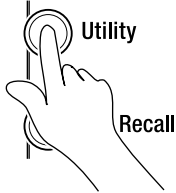

1179O010CB

- 2 Touch **Admin. Mode**.

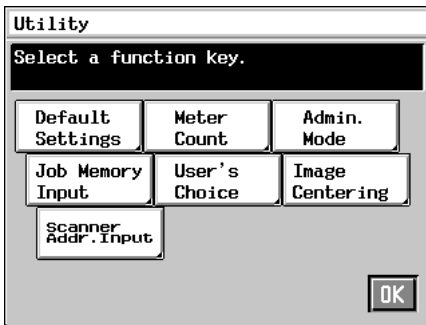

1179P356CA

- 3 Enter your administrator code number from the 10-Key Pad, then touch **OK**.



1179P360CA

- 4 Touch **Gradation Adjust**.

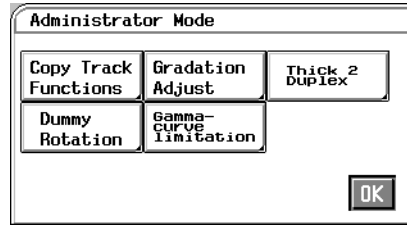

1179P361CB

- 5 Press the Start key.

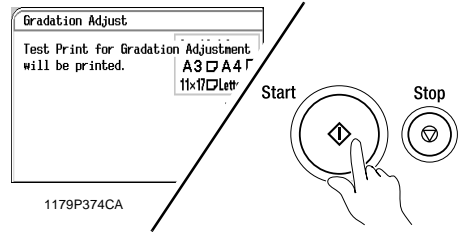

1179P374CA

1179O009CB

- 6 The copier produces a test print.

- 7 Place the test print produced on the Original Glass as shown.

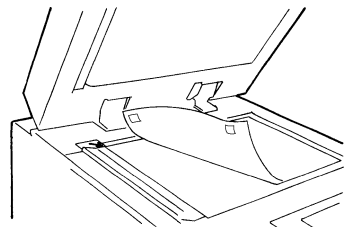

1179O019AC

NOTES

- Your Technical Representative sets or changes the administrator code number. Consult him or her for more details.
- Be sure to remember your administrator code number.

- 8 Cover the test print with 10 sheets of blank, white A3 or 11"×17" size paper.

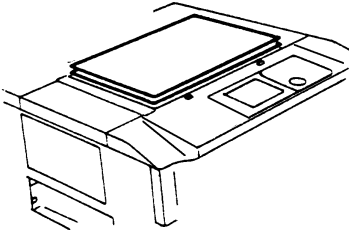

- 9 Close the Original Cover and press the Start key.

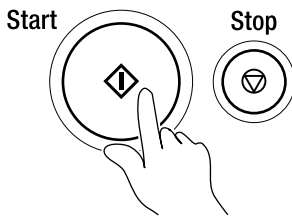

1179O009CB

- 10 When the copier is through with the Gradation Adjust sequence, the menu screen reappears.

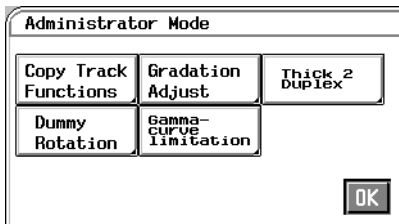

1179P361CB

Repeat steps from **4** to **9** three times.

5. Dummy Rotation

When Dummy Rotation is turned ON, improved accuracy in correct alignment among different colors results. The copying speed will become slower as a by-product (8 copies/min. → 6 copies/min.). The initial setting is OFF. If you are satisfied with the copy quality, keep the setting as is.

Changing Dummy Rotation Setting

1 Press the Utility key.

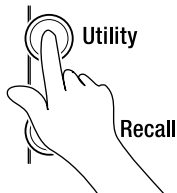

1179O010CB

2 Touch **Admin. Mode**.

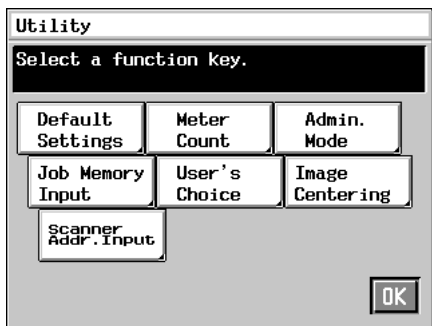

1179P356CA

3 Enter your administrator code number from the 10-Key Pad, then touch **OK**.



1179P360CA

4 Touch **Dummy Rotation**.

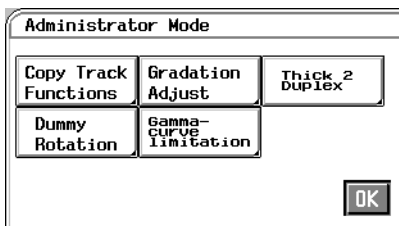

1179P361CB

5 Touch either **ON** or **OFF**.

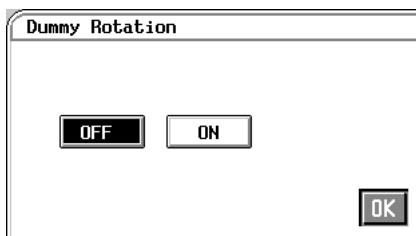

1179P375CA

6 Touch **OK**.

NOTES

- Your Technical Representative sets or changes the administrator code number. Consult him or her for more details.
- Be sure to remember your administrator code number.

6. Gamma-Curve Limitation

If Gamma-Curve Limitation is turned ON before producing printed pages of high image density as a full-color printer used in computer environment, it helps prevent image failure. If it is turned OFF, high image density can be faithfully reproduced. The initial setting is ON.

Gamma-Curve Limitation Setting

- 1 Press the Utility key.

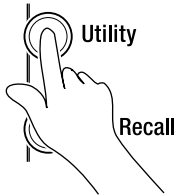

1179O010CB

- 2 Touch **Admin. Mode**.

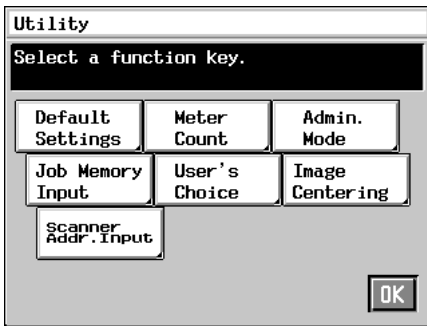

1179P356CA

- 3 Enter your administrator code number from the 10-Key Pad, then touch **OK**.



1179P360CA

- 4 Touch **Gamma-Curve Limitation**.

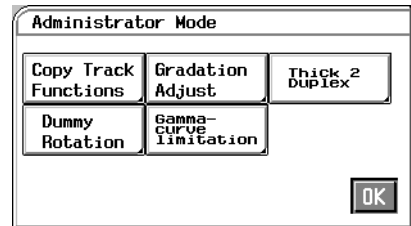

1179P361CB

- 5 Touch either **ON** or **OFF**.

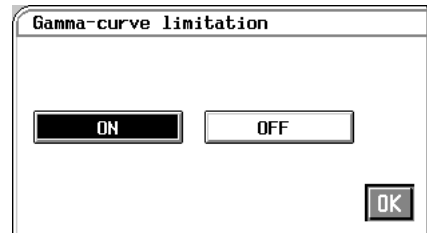

1179P376CA

- 6 Touch **OK**.

NOTES

- Your Technical Representative sets or changes the administrator code number. Consult him or her for more details.
- Be sure to remember your administrator code number.

7. Thick 2 Duplex

Noise can occur on the image of a 2-sided copy made on some type of thick paper, i.e., Thick 2 (weighing 129 to 209 g/m²). Thick 2 Duplex allows you to select whether to show (“Yes”) a key for the exclusive use for setting the Thick 2 Duplex function that ensures a noise-free 2-sided copy or not (“No”). The initial setting is “No.”

Thick 2 Duplex Setting

- 1 Press the Utility key.

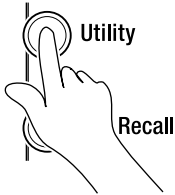

1179O010CB

- 2 Touch **Admin. Mode**.

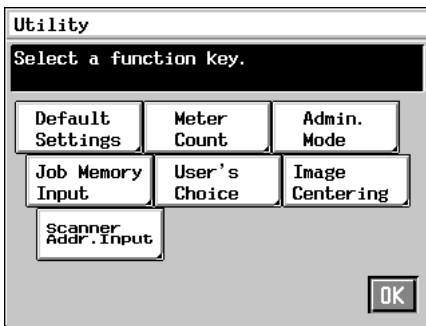

1179P356CA

- 3 Enter your administrator code number from the 10-Key Pad, then touch **OK**.



1179P360CA

- 4 Touch **Thick 2 Duplex**.

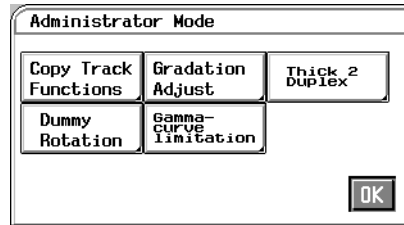

1179P361CB

- 5 Touch **YES** or **NO**.

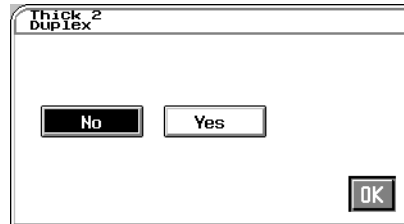

1179P417CA

- 6 Touch **OK**.

NOTES

- Your Technical Representative sets or changes the administrator code number. Consult him or her for more details.
- Be sure to remember your administrator code number.

Making 2-Sided Copies on Thick 2

- 1 Place a sheet of paper on the Manual Bypass Tray and touch **Paper Type**.

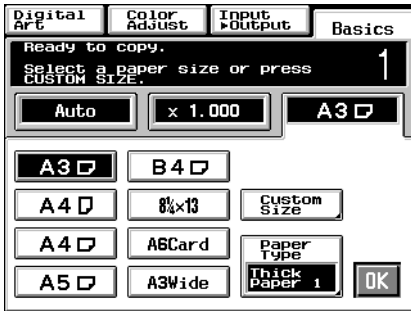

1179P177DB

- 2 Touch **Thick 2 Duplex** and select **NO** for 2nd Side for Dup.

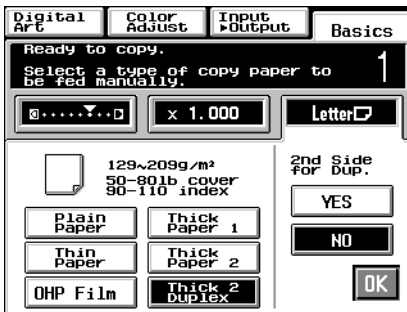

1179P424DA

- 3 Press the Start key to make a copy of the first side of the original.

- 4 Place the 1-sided copy made in step 3 on the Manual Bypass Tray and touch **Paper Type**.

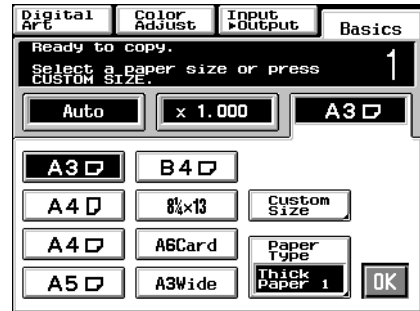

1179P177DB

- 5 Touch **Thick 2 Duplex** and select **YES** for 2nd Side for Dup.

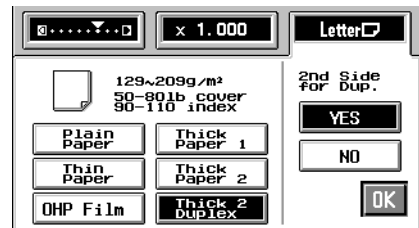

1179P425DA

- 6 Press the Start key to make a copy of the second side of the original.

Useful Tip

See p. 3-11 for the manual bypass copying procedures.

8. Storing and Calling Jobs

You can store ten frequently used job settings in memory to call up later for quick job setup.

Job Memory Input Procedure

- 1 Make the necessary control panel settings for the job.
- 4 Touch the number to assign the programmed job to, then touch **Input**.

- 2 Press the Utility key.

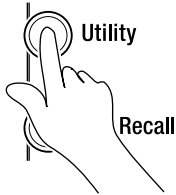

11790010CB

- 3 Touch **Job Memory Input**.

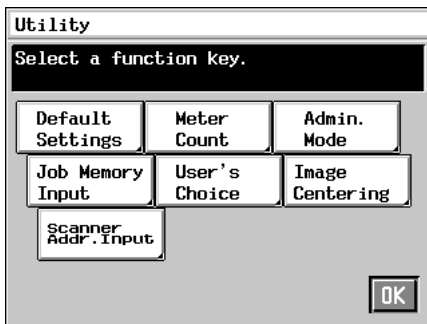

1179P356CA

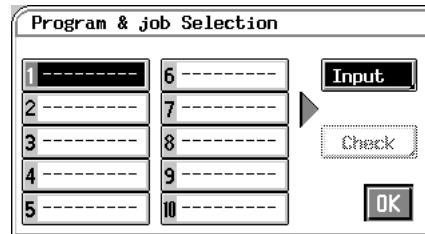

1179P377CA

Useful Tip

If a new program is stored in a job number in which another one has previously been stored, the old one is erased.

- 5 Name the job.
Touch the alphanumeric keys on the Touch Panel to enter the name, then touch **OK**.



1179P378CA

Useful Tip

If you touch **Check**, a screen appears that allows you to check the programmed job settings stored in memory.

- 6 Touch **OK**.

Calling up a Job

- 1 Press the Job Recall key.

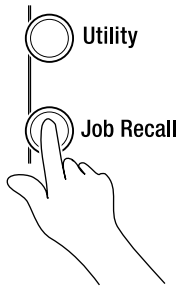

11790011CB

- 2 Touch the number that your programmed job has been assigned to.

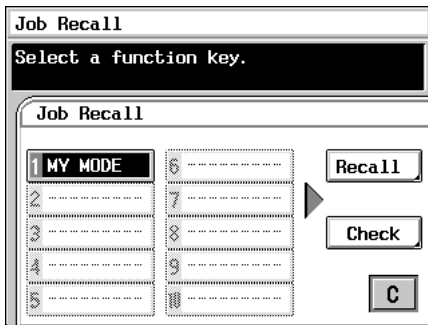

1179P379CA

Useful Tip

If you touch **Check**, a screen appears that allows you to check the programmed job settings stored in memory.

- 3 Touch **Recall**.

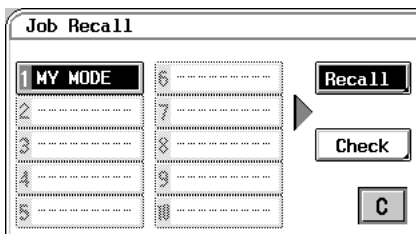

1179P389CA

- 4 Touch **OK**.

9. User's Choice

This function allows you to select customized default settings that are automatically selected when the copier is powered ON. It eliminates the need of making selections again to suit your needs every time the copier is turned ON or the panel is reset.

User's Choice Functions

Item	Description
Language	Select the language to be displayed on the Touch Panel. The initial setting is English.
Energy Saver	Select whether to set the copier into the Energy Saver mode (ON) or not (OFF) after a given period of time after the copy cycle has been completed or a key pressed. When "ON" is selected, set the time to enter this mode, which can range from 1 to 240 min., from the 10-Key Pad. The initial setting is "15 min."
Auto Reset	Select whether to reset the control panel settings (ON) or not (OFF) after a given period of time after the copy cycle has been completed or a key pressed. When "ON" is selected, set the time to activate this function, which can range from 1 to 9 min., from the 10-Key Pad. The initial setting is "5 min."
Confirmation Beep	Select whether to turn "ON" or "OFF" the confirmation beep that sounds when any of the keys on the Touch Panel is pressed. The initial setting is ON .
Key Counter	Select whether to reset (ON) the control panel settings or not (OFF) when the Plug-In Counter is unplugged or magnetic card is removed. The initial setting is ON .
Intelligent Sort	Select whether to turn the Intelligent Sort function ON (Auto Select) or OFF (Non-Auto) to automatically switch between Sort and Non-Sort according to the number of originals, when a copy cycle is run on a copier system equipped with a Sorter and Duplexing Document Feeder, both activated. Non-Sort is selected when the number of originals is 1 and Sort is selected when the number of originals is 2 or more. The initial setting is Auto Select .
Custom 2in1	It is possible for you to set whether to automatically recall the copy paper and zoom ratio previously stored in memory when 2in1 is selected. The default setting is "Select" with settings of "Auto Paper" for Paper Source and "×0.707" for Zoom.
ACS Judgement Level Adjust.	Set the image level of the Auto Color mode towards monochrome or full color as necessary. The initial setting is "Std."

User's Choice Setting Changing Procedure

- 1 Press the Utility key.

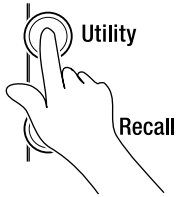

11790010CB

- 2 Touch **User's Choice**.

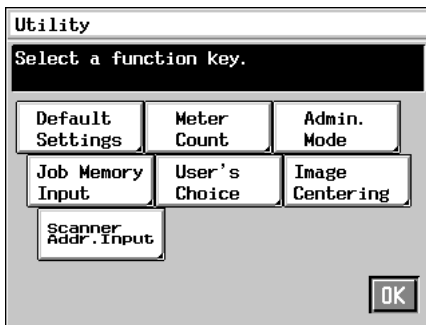

1179P356CA

- 3 Touch the Function key that you want to change.
As an example, **Energy Saver** is touched.

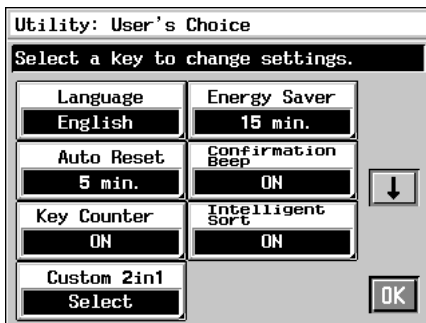

1179P380CA

- 4 When **ON** is touched, it is highlighted and the Touch Panel allows you to enter the time to the right of the **ON** key.

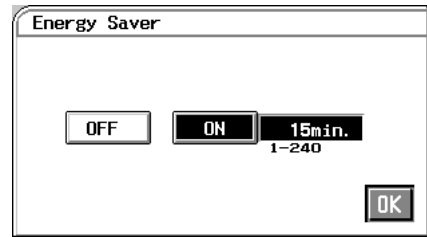

1179P381CA

- 5 Enter the time from the 10-Key Panel.
To correct a number, press the Clear Key, then enter the correct one.

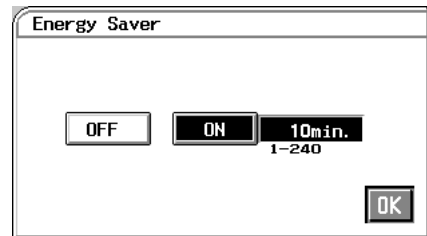

1179P382CA

- 6 Touch **OK**.

Useful Tip

If you want to change the setting for another function or functions, repeat steps 3 to 6.

Useful Tip

Touch  as necessary to reach the other functions.

10. Image Centering

This function automatically shifts the image of the original placed in parallel with the Original Scales towards the center of the copy paper as it is reproduced on the copy paper.

Turning ON or OFF Image Centering

- 1 Press the Utility key.

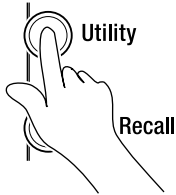

11790010CB

NOTE

When Centering is set to **ON** and when an original with a dark image is copied, the copier may detect a wrong original size, making the copy on small size paper. If this happens, turn **OFF** Centering.

- 2 Touch **Image Centering**.

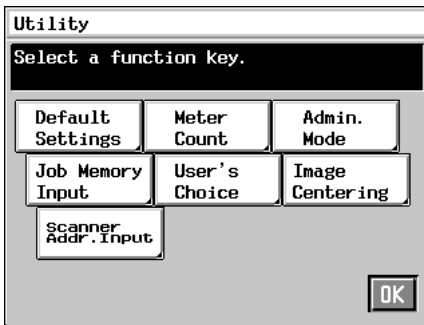

1179P356CA

- 3 Select either **ON** or **OFF**.

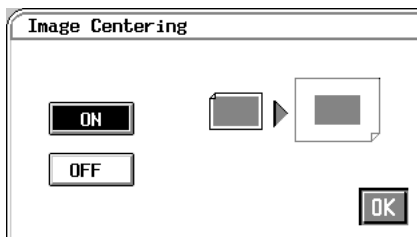

1179P383CA

- 4 Touch **OK**.

11. Scanner Address Input

Scanner Address Input

Scanner Address Input is used when a Printer Controller is connected to the copier. For details, see the manual that comes with the Printer Controller.

Chapter 6

When a Message Appears

1. When the Message “Load paper in the XXXX Tray.” Appears

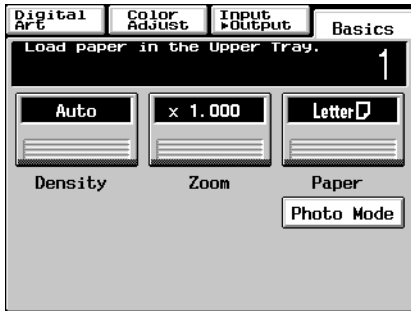

1179P397EA

When the Tray currently selected for use runs out of paper, the message shown on the left appears. The current copy cycle is interrupted and you cannot start a new copy cycle. Load the tray with paper by using the following procedure:

NOTE

Only the following type of paper can be loaded in the tray. Use of paper recommended by us is encouraged to keep a given level of copy quality and prevent paper misfeed.

- Paper weight: 17 lb to 34lb

- Size: 11×17 lengthwise to Invoice lengthwise

Thick Paper 2 and OHP films cannot be loaded in the tray.

Paper Loading Procedures

Upper and Lower Trays

- 1 Slide the Tray out.
- 2 Load the paper stack into the Tray so that its front side (the side facing up when the package was unwrapped) **faces down**. Then, slide the Tray back in.

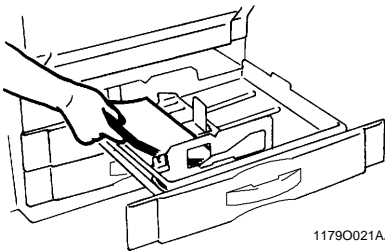

1179O021AA

Middle Tray

- 1 Slide the Tray out.
- 2 Load the paper stack into the Tray so that its front side (the side facing up when the package was unwrapped) **faces down**. Then slide the Tray back in.

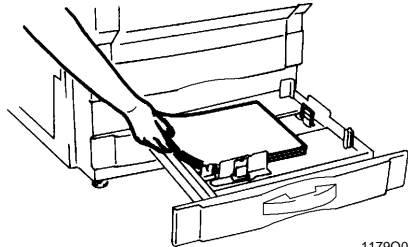

1179O023AA

NOTES

- Up to 500 sheets of paper (21-1/4 lb) can be loaded.
- The paper should be loaded no higher than the ▼ (Max. Level Indicator).

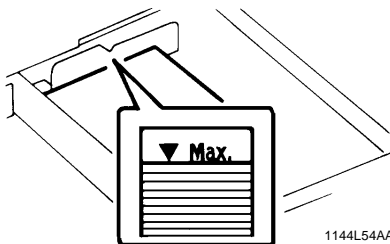

1144L54AA

NOTES

- Up to 250 sheets of paper (21-1/4 lb) can be loaded.
- The paper should be loaded no higher than the ▼ (Max. Level Indicator).

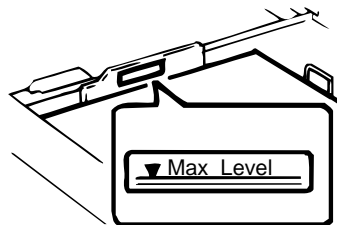

1144L044AA

1. When the Message “Load paper in the XXXX Tray.” Appears

Changing the Paper Size for the Middle Tray (Universal Tray)

- 1 Grasp the tab of the Edge Guide and slide it to the size of the paper to be loaded. Pressing the plastic part of the Trailing Edge Stop, slide it to the size of the paper to be loaded.

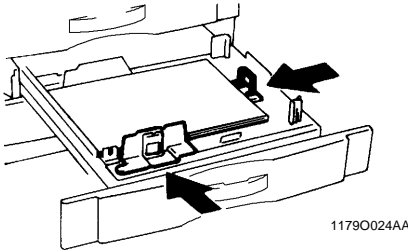

NOTE

When loading 11×17 inch paper: Move the Trailing Edge Stop all the way to the right. Then, pinch the Lever as shown and remove it from the Stop. Next, fit the Lever into position as shown.

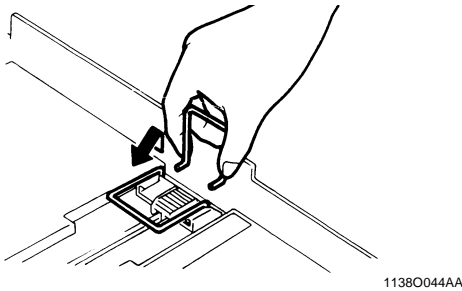

When loading the Inch size paper

Flip the Switch, located in the right rear corner of the Tray, to [Metric].

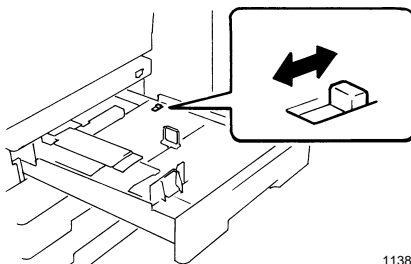

Large Capacity Cassette

- 1 Grasping the Door Lock Release Lever, open the Cassette Door.

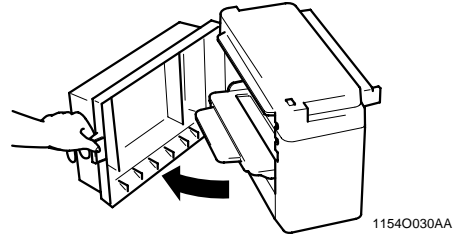

When adding paper to a partially loaded Cassette, press the Paper Plate Descent Key to lower the Paper Plate before opening the Cassette Door.

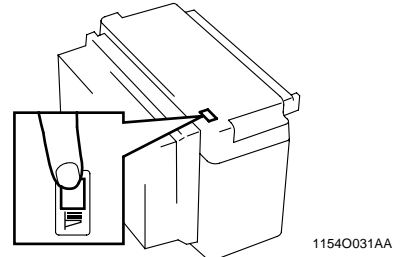

- 2 Place the paper stack onto the Paper Plate so that its front side faces up and close the Cassette Door.

*This causes the Paper Plate to rise automatically.

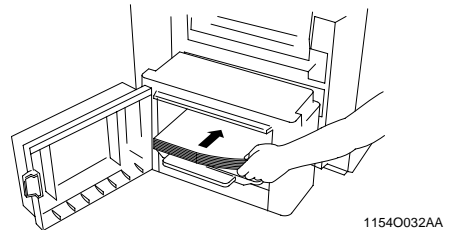

NOTES

- Make sure that the leading edge of the paper stack is pressed tightly up against the Guide Plate on the take-up side of the Cassette.
- The paper should be loaded no higher than the ▼ (Max. Level Indicator).

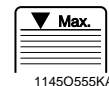

- The Paper Plate may not ascend if the Cassette Door is not closed completely. Be sure to close the Door completely.

2. When the Message “Please add Toner.” Appears



1179P391CA

The message shown on the left appears when toner is soon running out. You can still make copies, but the image density will become lighter and lighter. It is recommended therefore that you replenish the toner as soon as possible.

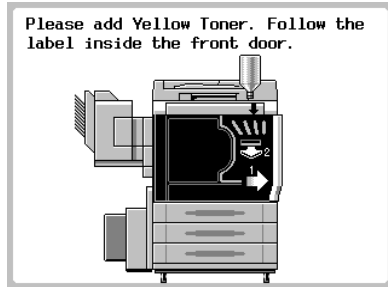

1179P420CA

When toner has run out, the message shown on the left appears and you can no longer start a new copy cycle. Replenish the toner by following the procedure given below.

Replenishing Toner

- 1 Open the Front Door.
(Example: Yellow Toner is empty.)

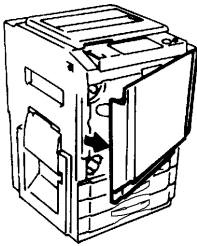

1179O025AA

- 3 Sharply tap the new Toner Bottle against a desk or other hard object four to five times. Then turn the Toner Bottle upside down and tap it the same way again.

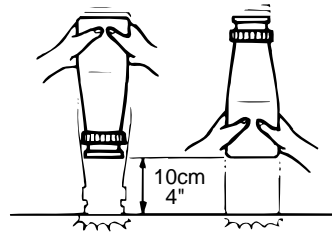

1144L079AB

- 2 Slide out the Toner Hopper Unit.

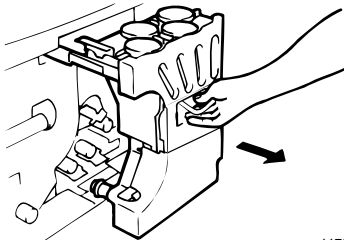

1179O057AA

- 4 Shake the Toner Bottle well.

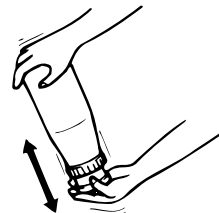

1144L078AB

2. When the Message "Please add Toner." Appears

- 5 Remove the bottle cap and peel off the seal.



1179O059AA

- 6 Open the Toner Hopper Lid.

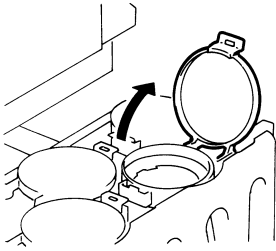

1144L014AA

NOTE

Make absolutely certain that the color of the toner matches the color of the Toner Hopper Lid.

- 7 Align the tab on the Bottle with the cutout on the Toner Receptacle and turn the Bottle clockwise until it stops.

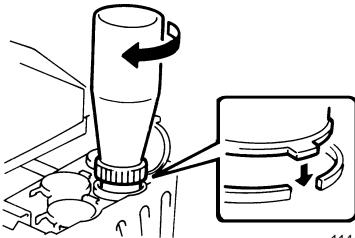

1144L017AA

- 8 Wait until the toner stops falling in (approx. 60 seconds), then tap the Bottle a few times to ensure that all the toner falls into the Hopper.

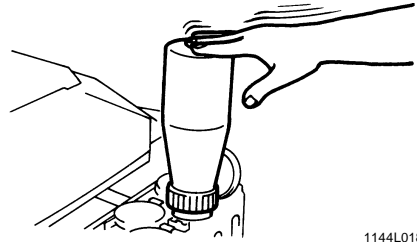

1144L018AA

- 9 Making sure that the toner has emptied completely, turn the Bottle counterclockwise and lift it out from the Receptacle. Close the Toner Hopper Lid.

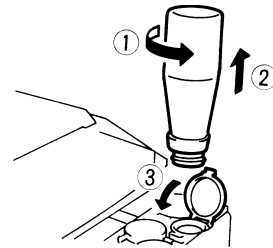

1144L019AA

NOTE

Please wait for a while after the toner has fallen in completely. If not, toner powder may be blown up from the Toner Hopper.

- 10 Slide the Toner Hopper Unit back in and close the Front Door.

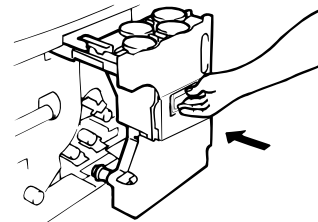

1179O073AA

- 11 Use the same procedure to add toner for the other three Main Hoppers.

3. When the Message “The Staple Cartridge is empty.” Appears

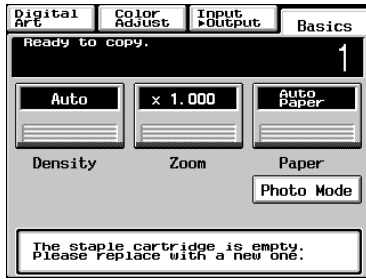

1179P392CA

The message shown on the left appears when the staples are running out.

Replace the Staple Cartridge with a new one by following the procedure given below.

Replacing the Staple Cartridge

- 1** Grasping the Lock Release Lever, slide the Staple Sorter away from the copier.

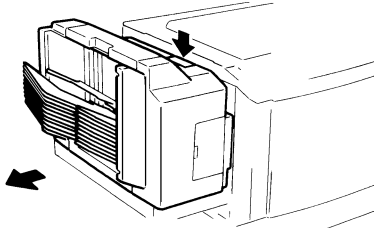

1144O252AA

- 2** Open the Stapler Door.

- 3** While pushing up the Staple Cartridge Release Lever, pull the Staple Cartridge out of its port.

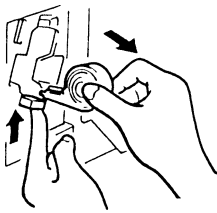

1136O003AA

- 4** Pull the staple sheet about 3 cm out of the new Staple Cartridge and break off that portion.

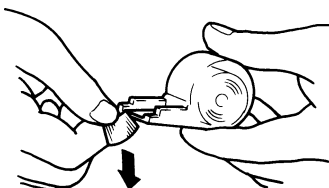

1139O0970A

NOTE

Check that no portion of the staple sheet hangs out of the Cartridge. Break off any portion of the sheet that hangs out of the Cartridge.

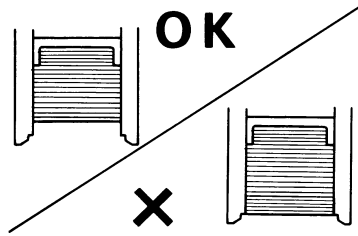

1134O077AA

- 5** Insert the new Staple Cartridge until a click is heard.

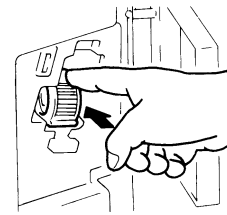

1139O1440A

- 6** Close the Stapler Door and slide the Staple Sorter back against the copier.

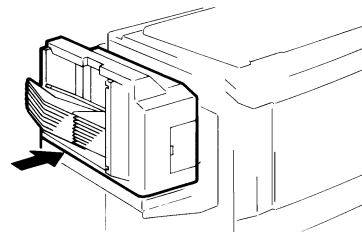

1144O253AA

3. When the Message “The Staple Cartridge is empty.” Appears

- 7 Place a sheet of paper into the 2nd Bin of the Staple Sorter.

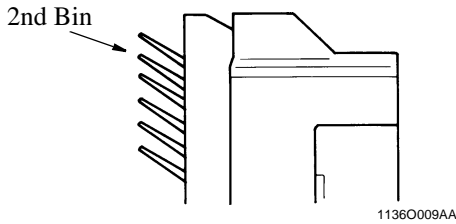
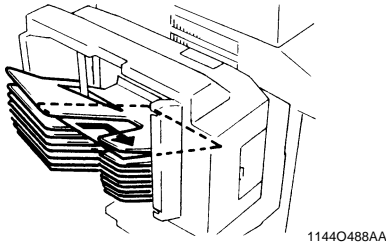

- 8 Touch **Staple** on the Touch Panel. Then, the Staple Sorter test-staples the paper several times automatically.



- 9 Remove the sheet of paper from the 2nd Bin and check that it has been stapled.

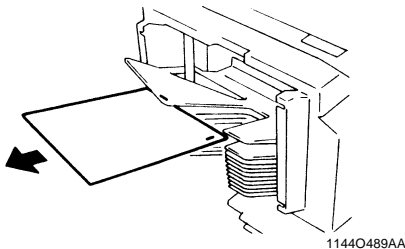

- * If no staples are evident, place another sheet of paper into the 2nd Bin and repeat steps 7, 8, and 9.

NOTES

- Replace the Staple Cartridge only after you are prompted to do so by the message. Removing the Staple Cartridge before then will result in stapling trouble.
- Immediately after the new Staple Cartridge has been loaded, be sure to test-staple the paper following steps 7 through 9.
- **DO NOT** turn the green gear near the Cartridge inside the Staple Unit.

4. When the Message “Misfeeding is detected.” Appears

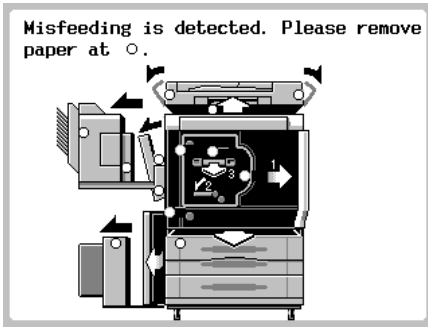

1179P421CA

If a paper misfeed occurs during a copy cycle, the message shown on the left appears and that particular copy cycle is stopped in the middle of operation.

Clear the misfed sheet of paper according to the procedure given below.

Misfeed Location Displays

Different procedures are used to clear a misfed sheet of paper depending on the location. First, isolate the location, then clear the misfeed following the procedure applicable to where the misfeed occurred.

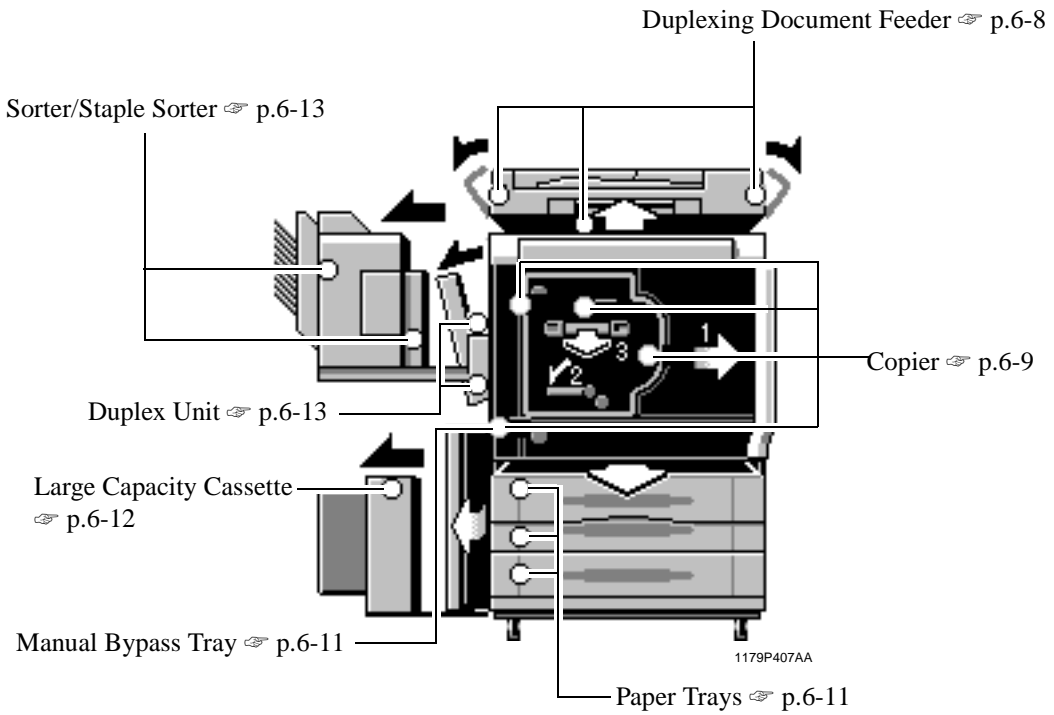

1179P407AA

Misfeed Clearing Procedures

Duplexing Document Feeder

- 1** Remove the original stack from the Document Feed Tray.

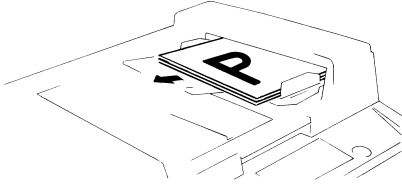

1151O097AA

- 2** Swing open Document Feed Unit Door (F1) and gently pull out the original.

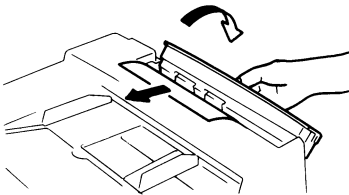

1151O031AA

- 3** Holding down the Lock Release Button, swing open Document Turnover/Exit Unit Door (F2) and carefully pull out the original from the Exit Unit.

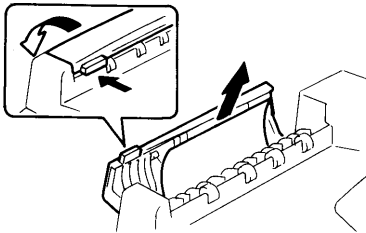

1151O032AB

- 4** Close (F1) and (F2).

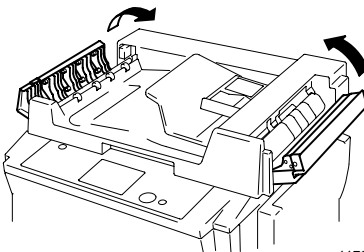

1179O060AA

- 5** Raise the Duplexing Document Feeder. Opening the Document Turnover/Feed Unit Guide Plate, gently pull out the original from the Unit.

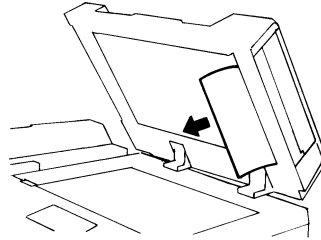

1151O033AA

- 6** Remove the original from the Original Glass and lower the Duplexing Document Feeder.

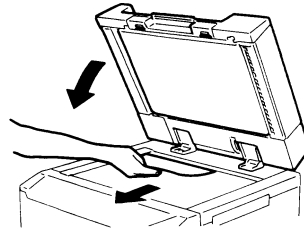

1139O0840A

- 7** When the message “Re-insert the following # of originals” is shown on the Display, return the number of originals indicated on the Display to the bottom of the original stack removed in step 1 and reload it onto the Document Feed Tray.

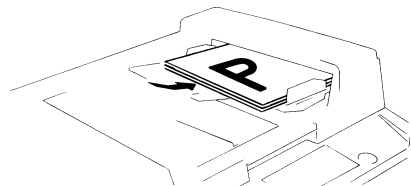

1151O088AA

4. When the Message “Misfeeding is detected.” Appears

Copier

1 Open the Left Door (L1) .

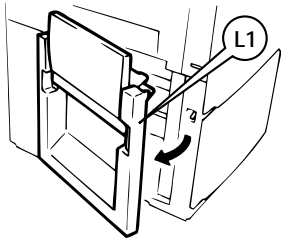

1144O548AA

5 Close the Left Door (L1) .

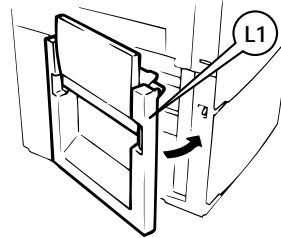

1144O549AA

2 Pull out the sheet of paper from the Transport Section.

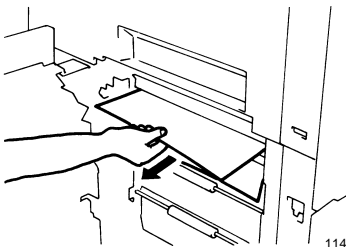

1144L022AA

6 Open the Front Door.

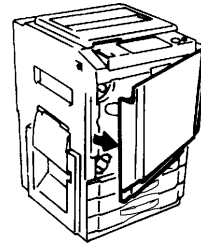

1179O025AA

3 Raise Guide Plate (M2) and, turning Knob (M1) , pull out the sheet of paper.

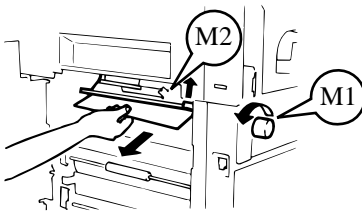

1144L023AA

7 Turn the Lever (M4) to the left. Press Guide Plate (L2) and, turning Knob (M5) , pull out the sheet of paper.

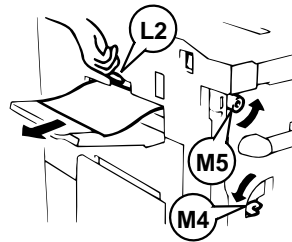

1144L026AB

4 Press down Guide Plate (M3) and pull out the sheet of paper.

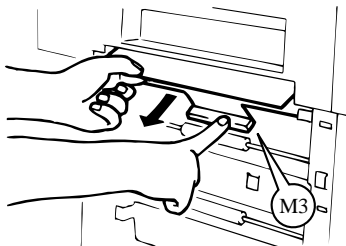

1144L024AA

8 Grasp Lever (M6) and slide out the Transfer/Fusing Unit.

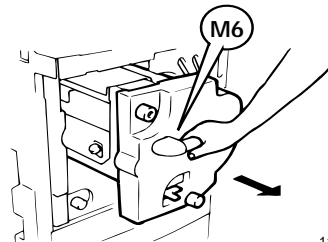

1144L027AB

4. When the Message “Misfeeding is detected.” Appears

- 9** Grasp the Fusing Unit Lever (M7) and open the Fusing Unit.

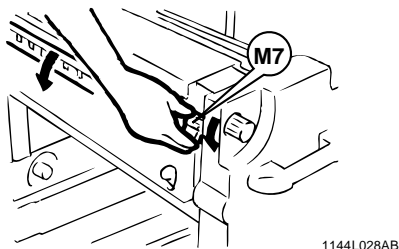

⚠ CAUTION

DO NOT touch any parts except paper as the Fusing Unit and its surrounding areas are extremely hot.

- 10** Turning Knob (M5), pull out the sheet of paper and close the Fusing Unit.

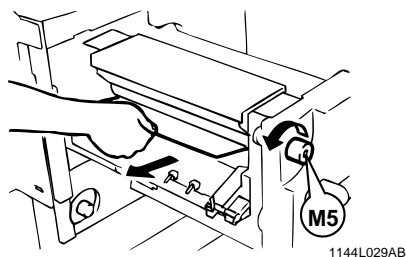

- 11** Pull out the sheet of paper from the Upper Area of the Transfer/Fusing Unit.

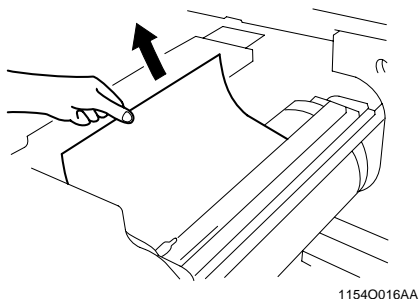

- 12** Turning Knob (M9), remove the sheet of paper. If paper is stuck to the Transfer Film, carefully disengage the leading edge of the paper and remove it with care not to damage the Transfer Film.

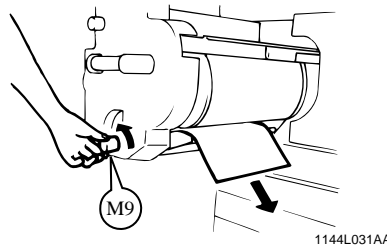

- 13** Press down the Roller as shown and remove the sheet of paper if present inside.

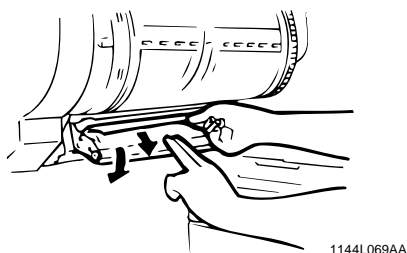

- 14** Slide the Transfer/Fusing Unit back into the copier and turn the Release Lever (M4) to the right.

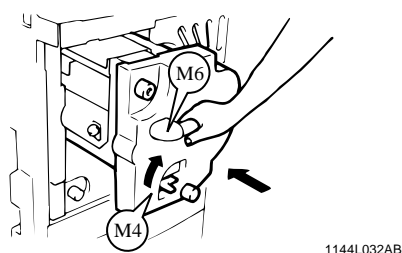

- 15** Close the Front Door.

4. When the Message “Misfeeding is detected.” Appears

Paper Trays

- 1 Open the Left Door (L1) and pull out the sheet of paper from the Transport Section.

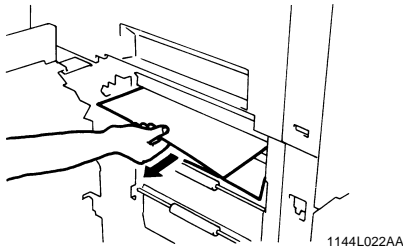

- 2 Close the Left Door (L1).

- 3 Slide the Tray out.

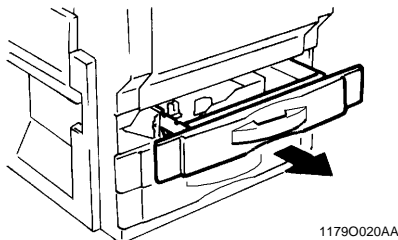

- 4 Unload the paper stack from the Tray. Fan the paper thoroughly and reload it in the Tray.

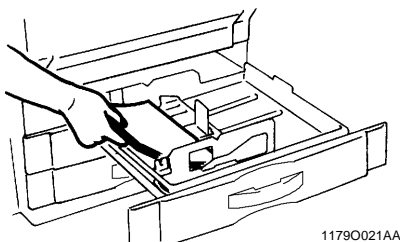

- 5 Slide the Tray back in.

- 6 Open the Front Door and then close it to reset the misfeed indication/message on the Touch Panel.

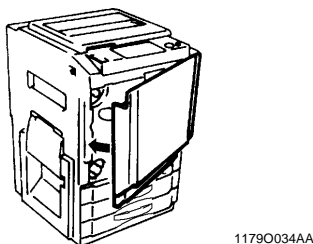

Manual Bypass Tray

- 1 Unload the paper stack from the Manual Bypass Tray. Then open the Left Door (L1).

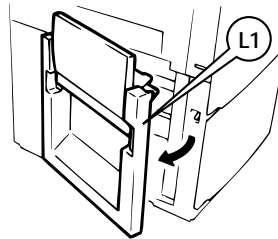

- 2 Raise Guide Plate (M2) and, turning Knob (M1) pull out the sheet of paper. Then, close the Left Door.

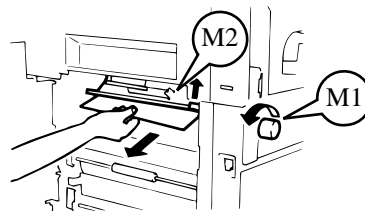

- 3 Fan the paper stack thoroughly and place it back on the Tray.

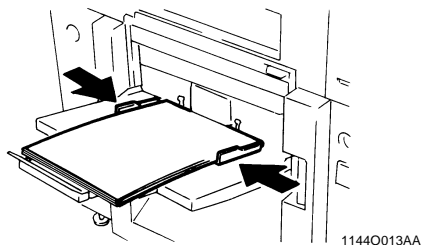

- 4 Open the Front Door and then close it to reset the misfeed indication/message on the Touch Panel.

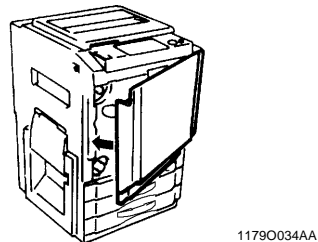

4. When the Message "Misfeeding is detected." Appears

Large Capacity Cassette

- 1** Press the Paper Descent Key.

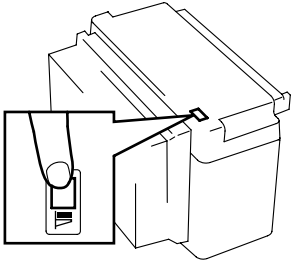

1154O031AA

- 2** Grasping the Door Lock Release Lever, open the Cassette Door and remove the sheet of paper.

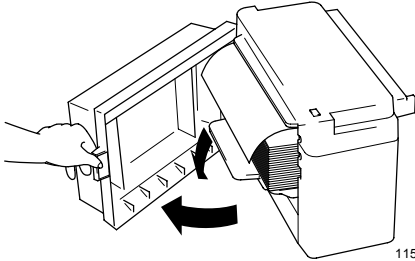

1154O034AA

- 3** Close the Cassette Door.

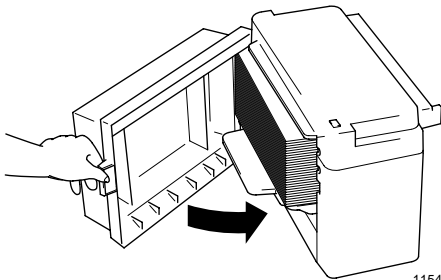

1154O033AA

- 4** Grasp the Cassette Release Lever and slide the Cassette away from the copier.

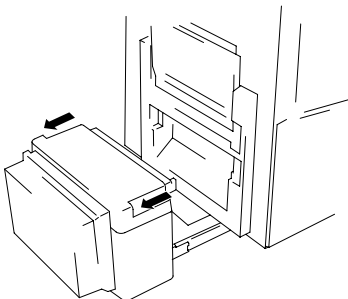

1154O035AA

- 5** Remove the sheet of paper.

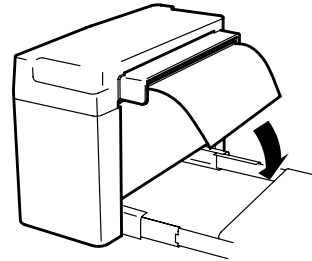

1154O036AA

- 6** Slide the Cassette back against the copier.

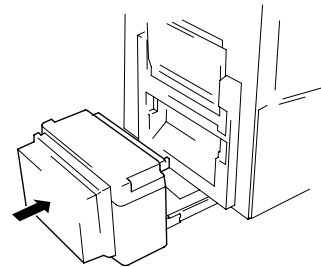

1154O037AA

4. When the Message “Misfeeding is detected.” Appears

Duplex Unit

- 1 Grasping the Lock Release Lever, open the Duplex Unit.

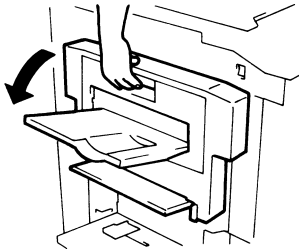

1144L034AA

- 2 Open the Misfeed Removal Guide (D) and pull out the sheet of paper.

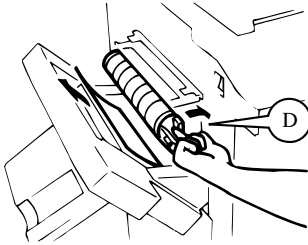

1144L035AA

- 3 Close the Duplex Unit.

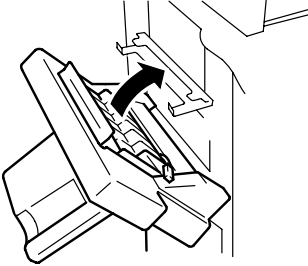

1154O040AA

Sorter/Staple Sorter

- 1 Grasping the Lock Release Lever, slide the Sorter away from the copier.

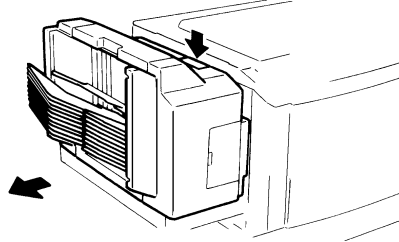

1144O252AA

- 2 Pull out the copy from the Transport Section.

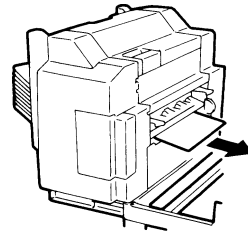

1139O0870A

- 3 Slide the Sorter back against the copier.

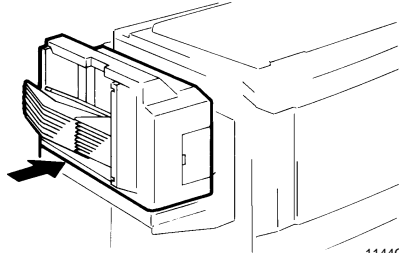

1144O235AA

5. When the Message “The Fuser Oil has run out.” Appears

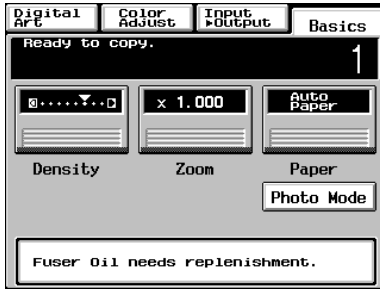

1179P427CA

The message shown on the left appears when the Fuser Oil is running out. You can still make copies, but it is recommended that you replenish the Fuser Oil as soon as possible.



1179P426CA

When Fuser Oil has run out, the message shown on the left appears and you can no longer start a new copy cycle. Replenish the Fuser Oil by following the procedure given below.

Usually, the Fuser Oil replenishment should be performed by a qualified service representative. However, on an as need basis, the Copier can be set so that a trained operator can replenish the Fuser Oil. In this case, we recommend that only a trained key operator replenish the Fuser Oil according to the following procedure.

Replenishing the Fuser Oil

1 Open the Front Door.

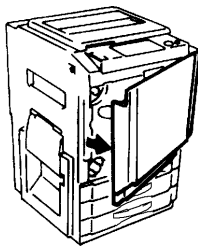

1179O025AA

2 Turn the Lever (M4) to the left. Grasp the Lever (M6) and slide out the Transfer/Fusing Unit.

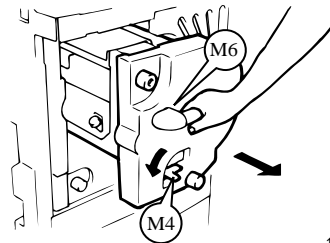

1144L027AA

5. When the Message “The Fuser Oil has run out.” Appears

- 3** Remove the cap from the Fuser Oil Supply Port.

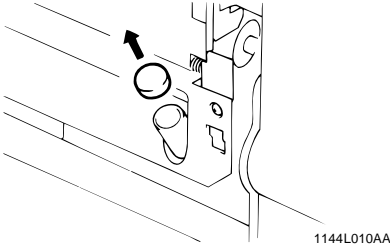

- 4** Remove the cap of the Fuser Oil Bottle and fit the Oil Supply Spout to the Bottle.

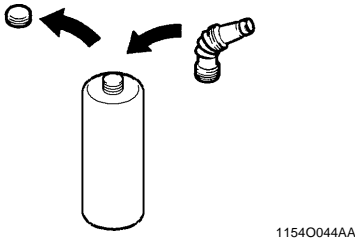

- 5** Replenish the Fuser Oil.

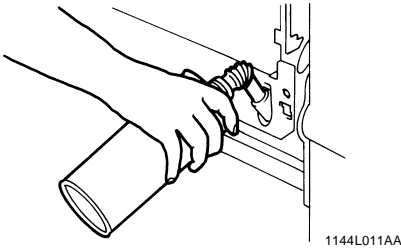

- 6** Remove the Oil Supply Spout and refit the cap to the Fuser Oil Bottle.

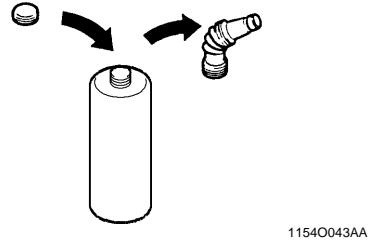

- 7** Refit the cap to the Oil Supply Port.

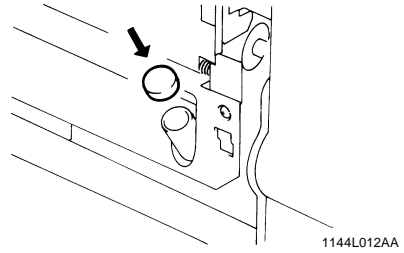

- 8** Slide the Transfer/Fusing Unit back in and turn the Lever (M4) to the right.

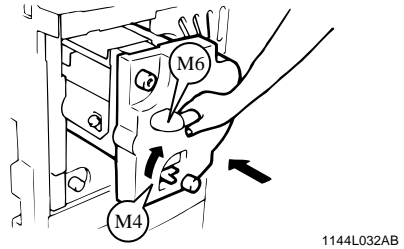

- 9** Close the Front Door.

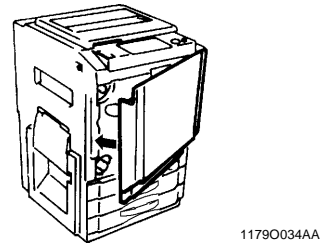

NOTES

- You will replenish approximately a half bottle of the Fuser Oil usually. Therefore, please be careful not to overfill the Fuser Oil reservoir, especially when replenishing from a new bottle.
- The Fuser Oil should be replenished no higher than the Max. Level Indicator.

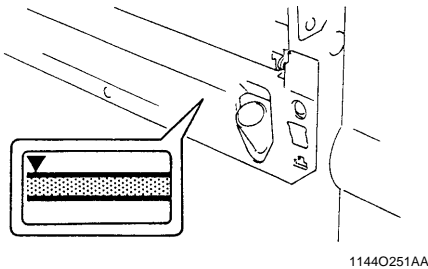

10 Press the Utility Key on the Control Panel.

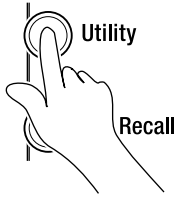

1179O010CB

11 Touch **Fuser Oil Refill**.

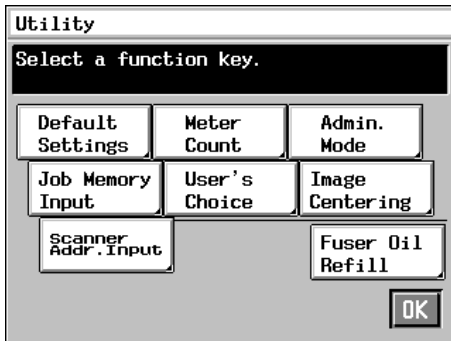

1179P428CA

12 Touch **Yes** and then touch **OK**.

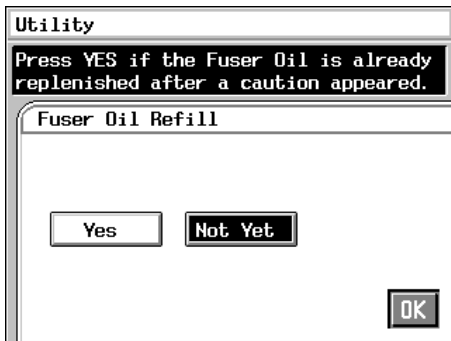

1179P429CA

13 Press the Panel Reset Key.

6. When or Appears

When Appears



1179P393CA

When  appears in the lower left corner of the Touch Panel, it indicates that something is wrong with the image stabilization function of the color copier. Call your Tech. Rep.

IMPORTANT

When  on the Touch Panel is touched, the following screen appears.

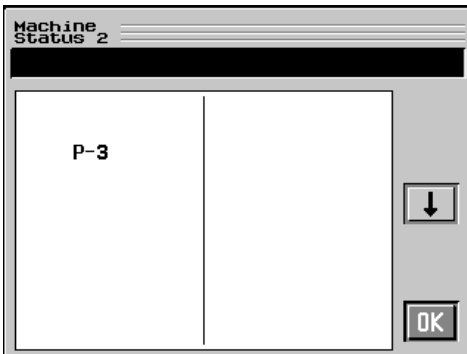

1179P394CA

When calling your Tech. Rep., inform him/her of the number or numbers under which “NG” is shown (in the above example, no. P-3).

When you touch **OK** after these procedures, the normal copying screen reappears.

When Appears

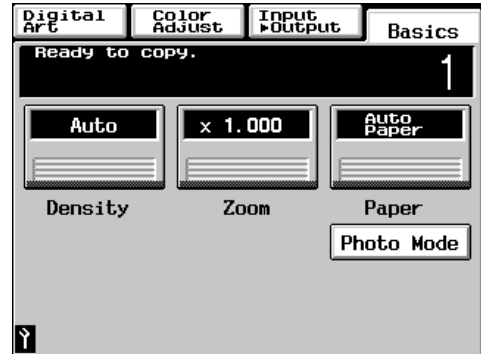

1179P395CA

If  appears in the lower left corner of the Touch Panel, it indicates that either the Upper, Middle, or Lower Drawer is disabled. Call your Technical Representative.

IMPORTANT

Touching  on the Touch Panel will show the following screen.

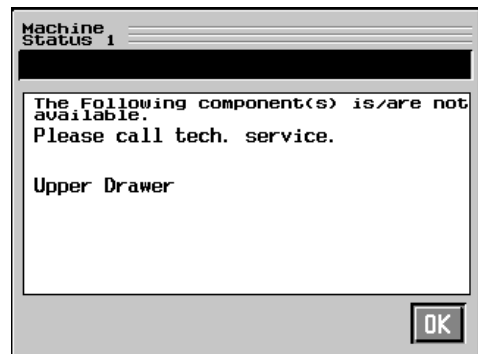

1179P395CA

When calling your Technical Representative, inform him or her of the name of the drawer being displayed (the Upper Drawer in the above example).

When you touch **OK** after these procedures, the normal copying screen reappears.

7. What Does Each Message Mean?

What Does Each Message Mean?

Message	Cause	Action
Please call tech. service. code: XXXXX	The copier malfunctioned and is unable to make copies.	Call and inform your Technical Representative of the code being shown on the Touch Panel.
Input your 4-digit Access Code Number, and press OK.	An access number has been set and the number assigned for your own department must be entered before you can make a copy.	Enter the 4-digit access number. (“Access Number” ☞ p.2-11)
Please insert the Key Counter.	The Key Counter is not plugged in and the copier is unable to make copies.	Plug in the Key Counter.
Load paper in the XXXXX Tray.	The currently selected Tray has run out of paper.	Load the Tray with paper. ☞ p.6-1
Please add XXXX Toner. Follow the label inside the front door.	Toner has run out and the copier is unable to make copies.	Replenish toner. ☞ p.6-3
	Toner is soon running out.	
The Staple Cartridge is empty. Please replace with a new one.	The staples have run out.	Replace the Staple Cartridge with a new one. ☞ p.6-5
Misfeeding is detected. Please remove paper at ○.	A misfeed has occurred and no copy cycle can be initiated.	Clear the misfed sheet of paper. ☞ p.6-7
The section indicated by → is open. Please close it properly.	A copier door is left open or an option is not attached properly and the copier is unable to make copies.	Close the door or cover and attach the option properly.
The Fuser Oil has run out. Please call your technical rep.	The Fuser Oil needs to be replenished.	Please call your technical representative.
The Fuser Oil has run out. Please replenish.	The Fuser Oil has run out and the copier is unable to make copies.	Please Replenish the Fuser Oil. ☞ p.6-14
Toner Collecting Bottle is nearly full. Please call your tech. rep.	The Toner Collecting Bottle is full and the copier is unable to make copies.	Please call your technical representative.
Copies remain in the Duplex Unit. Press START to feed them out.	A copy or copies are left in the Duplex Unit and the copier is unable to make copies.	Press the Start Key to remove all copies from the Duplex Unit.
Sorter has reached its capacity. Please remove all copies from bins first.	Sorter has reached its capacity. Remove all copies from the bins first.	Remove all copies from the Sorter Bins.

7. What Does Each Message Mean?

Message	Cause	Action
The orig. is left on the glass, remove it before proceeding.	You try to use the Duplexing Document Feeder when there is an original left on the Original Glass.	First remove the original from the Glass, then load the originals in the Duplexing Document Feeder.
Max. # of sets for sorting is 10.	You have entered 11 or more for the number of copies to be made in a sort/sort and staple mode.	Reenter 10 or less for the number of copies to be made.
Max. # for 2-sided copies is 1.	You have entered 2 or more for the number of copies to be made in a 2-sided copy mode.	Reenter 1 for the number of copies to be made.
Original size cannot be detected.	Original is not placed in the correct position.	Place the original correctly. ☞ p.3-3
	A non-standard size original is used.	Cancel the Auto Paper Mode and select the appropriate copy paper size. ☞ p.3-9
Matching size is not available.	No Trays contain paper of the right size to run a copy cycle in the Auto Paper Mode.	Cancel the Auto Paper Mode and select the appropriate copy paper size or make copies using the Manual Bypass Tray.
Place original on Original Glass.	The current control panel settings defy the use of the Duplexing Document Feeder.	Remove the originals from the Duplexing Document Feeder and place them, one by one, on the Original Glass. Or, cancel the current panel settings.

Chapter 7

Troubleshooting

1. When This Type of Copy is Produced

When This Type of Copy is Produced

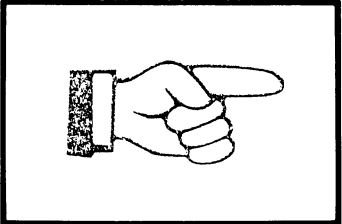
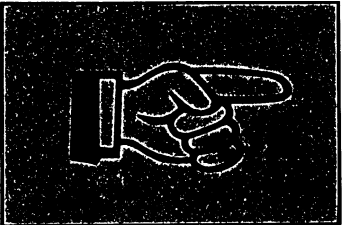
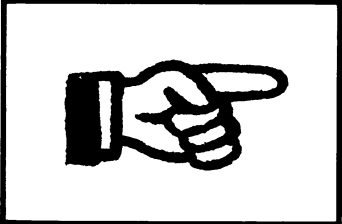
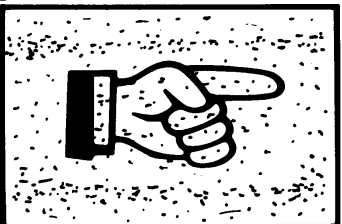
Symptom	Possible Cause	Action
The Image is too light.  <small>1074O108</small>	The manual exposure level is set on the lighter side.	Touch the Darker Key as necessary to obtain a darker image. ☞ p.3-18
	The message “Please add Toner.” is shown on the Touch Panel.	Replenish toner. ☞ p.6-3
	The paper is damp.	Replace the paper. ☞ p.6-1
	In cases other than the above.	Refer to the “Gradation Adjust”. ☞ p.5-11
The Image is too dark.  <small>1074O109</small>	The manual exposure level is set on the darker side.	Touch the Lighter Key as necessary to obtain a lighter image. ☞ p.3-18
	The entire surface of the Original Glass is dirty.	Wipe the Glass clean with a soft dry cloth. ☞ p.8-8
	The original is not held tightly against the Original Glass.	Place the original in position so that it is held tightly against the Glass. ☞ p.3-3
	In cases other than the above.	Refer to the “Gradation Adjust”. ☞ p.5-11
The Copy is blurry.  <small>1074O110</small>	The paper is damp.	Replace the paper. ☞ p.6-1
The Copy has dark specks or spots.  <small>1139O1660A</small>	The Original Glass is dirty.	Wipe the Glass clean with a soft dry cloth. ☞ p.8-8
	The Original Pad or Document Feed Belt is dirty.	Wipe the Original Pad or Document Transport Belt clean with a soft cloth dampened with mild detergent. ☞ p.8-7
	The original is very thin or highly transparent.	Place a blank sheet of paper over the original. ☞ p.3-3
	The original is two-sided.	The information on the back side of a two-sided, thin original may be slightly reproduced on the copy. Touch the Density Key and set Background to Auto or Lighter . ☞ p.3-18

1. When This Type of Copy is Produced

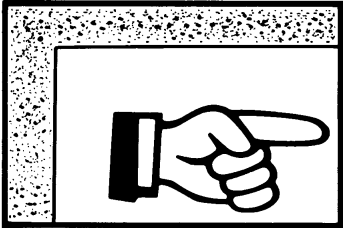
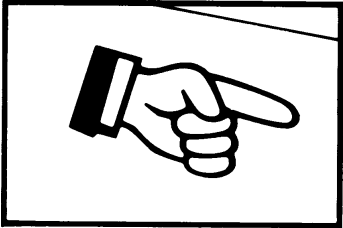
Symptom	Possible Cause	Action
<p>The Edge of the Copy is dirty.</p>  <p>1139O1690A</p>	<p>The Original Pad or Document Feed Belt is dirty.</p> <p>You have selected a paper size larger than the original. (Zoom Ratio is set at full size 100%)</p> <p>The original is not placed in the correct direction. (Zoom Ratio is set at full size 100%.)</p> <p>The reduction ratio selected is not in accord with the copy paper size. (When doing manual reduction copying.)</p>	<p>Wipe the Original Pad or Document Transport Belt clean with a soft cloth dampened with mild detergent. ☞ p.8-7</p> <p>Select the same copy paper size as the original. ☞ p.3-9 Or, use the Auto Size Mode to enlarge the copy to the appropriate size. ☞ p.3-13</p> <p>Select the Paper Tray that is loaded in the same direction as the original. ☞ p.3-9 Or, reload the paper in the same direction as the original. ☞ p.6-1</p> <p>Select the zoom ratio according to the copy paper size. ☞ p.3-13 Or, use the Auto Size Mode to reduce the copy to the appropriate size. ☞ p.3-13</p>
<p>The Image on the Copy is not aligned properly.</p>  <p>1139O1680A</p>	<p>The original is not placed in the correct position.</p> <p>The originals may not be suitable for use in the Duplexing Document Feeder. (When Duplexing Document Feeder is being used.)</p> <p>The Original Glass is dirty. (When Duplexing Document Feeder is being used.)</p>	<p>Place the original correctly on the Glass against the Width Scale. ☞ p.3-3 Or, load it onto the Duplexing Document Feeder correctly along the Document Guide Plates. ☞ p.3-6</p> <p>Raise the Duplexing Document Feeder and place the originals on the Glass one at a time, instead of using the Duplexing Document Feeder. ☞ p.3-3</p> <p>Wipe the Glass clean with a soft dry cloth. ☞ p.8-8</p>

2. The Copier is not functioning as designed

The Copier is not functioning as designed

Symptom	check for:	Action
The Touch Panel shows nothing.	Is only the Start Key lit up green?	The copier is in the Energy Saver Mode. Press any key on the Control Panel to cancel the Energy Saver Mode. ☞ p.2-10
	The Display Contrast Control Knob is placed in the excessively light or dark position.	Viewing the Touch Panel, turn the Display Contrast Control Knob as necessary.
The Start Key does not light up green.	Is your Access Number entered? 	Enter your Access Number. ☞ p.2-11
No copies are fed out when the Start Key is pressed.	The copier was just turned ON and is warming up.	It takes the copier about 9 minutes to be ready for making copies after it has been turned ON. Please wait.
	The copier has developed a malfunction.	Check the Touch Panel and take action according to the message on the Panel. ☞ p.6-18
Control Panel Keys do not respond.	The Interrupt Key LED is lit up.	The copier is in the interrupt mode. Press the Interrupt Key to cancel the interrupt mode. ☞ p.2-10
The copier is not activated when the Power Switch is turned ON.	The power cord is left unplugged from the power outlet.	Plug the power cord into the power outlet.
	The room circuit breaker is open.	Close the room circuit breaker.

If these procedures do not correct the problem, contact your Technical Representative.

Chapter 8

Miscellaneous

1. Specifications

Specifications

Copier CF9001	
Type	Console Copier
Platen	Stationary
Photoconductor	OPC
Copying System	Electrostatic Dry Powdered Image Transfer to Plain Paper
Developing System	Micro-Toning System
Fusing System	Lamp-Heated Roller
Resolution	600 dpi
Types of Original	Sheets, Books, and other three-dimensional objects Maximum Original Size : 11×17 Lengthwise Maximum Original Weight : 4-1/2 lb
Kinds of Paper	Tray Feeding : Thin Paper (20 lb), Plain Paper (20 lb to 24 lb), Thick Paper 1 (24 lb to 34 lb) Manual Feeding : Thin Paper (20 lb), Plain paper (20 lb to 24 lb), Thick Paper 1 (24 lb to 34 lb), Thick Paper 2 (50 lb to 80 lb cover), OHP Films (recommended brand)
Copy Paper Size	Upper/Lower Trays : 11×17L, 11×14L, 10×14L, LegalL, G.LegalL, Foolscap(9-1/4×14L, 8-2/3×13L, 8-1/4×13L, 8-1/4×11-3/4L), LetterL, LetterC, G.LetterL, G.LetterC, InvoiceL Middle Tray : 11×17L, LegalL, LetterL, LetterC, InvoiceL Manual Bypass Tray : 12×18L, 11×17L, LegalL, LetterL, LetterC, InvoiceL Crosswise: 5-3/4 to 11-3/4 Lengthwise: 7-1/4 to 17
Tray Capacity	Upper/Lower Trays (Fixed size type) : 500 sheets (21-1/4 lb) Middle Tray (Universal type) : 250 sheets (21-1/4 lb) Manual Bypass Tray : 90 sheets (Thin Paper, Plain Paper, Thick Paper 1) : 50 sheets (Thick Paper 2) : 40 sheets (OHP Films)
Warm-up Time	Approx. 9 minutes at ambient temperature of 20°C/68°F
Lost Image	Leading edge: 5 mm or less Trailing edge: 4 mm or less Front edge, Rear edge: 3 mm or less
First Copy	(in Full Size Mode using Letter crosswise paper and Upper Tray) Full-color : Less than 21 seconds Black : Less than 10 seconds
Copy Speed (Approx. copies/minute)	Full-color : 8 copies/min (LetterC) 4 copies/min (11×17L) 4 copies/min (10×14L) Black : 32 copies/min (LetterC) 16 copies/min (11×17L) 16 copies/min (10×14L)
Magnification Ratios	Fixed ratios Full size: 1:1 ±0.005 Reduction ratios: ×0.647, ×0.733, ×0.785 Enlargement ratios: ×1.214, ×1.294, ×4.000 Zoom ratios: From ×0.250 to ×6.000 in ×0.001 increments
Multiple Copies	Up to 99 copies (in 1-sided Copy Mode)
Exposure Control	Auto and Manual
Power Requirements	100V/50-60Hz, 120V/60Hz, 220-240V/50-60Hz
Power Consumption	1.5 kW (Max.)
Dimensions	Width : 25-1/4 inch Depth : 30 inch Height : 39-1/4 inch (Up to Original Cover surface)
Space Requirement	32-1/2 (Width) × 30 (Depth)
Weight	474 lb

Duplexing Document Feeder AFR-12

Document Feeding System	Standard Mode: 1-sided original 2-sided original 2-in-1 Single Automatic Document Feeding Mode Mixed Original Detection Mode: 1-sided mixed original detection 2-sided mixed original detection
Type of Original	1-sided Original Mode, : 13-1/4 lb to 29-1/4 lb 2-in-1 Mode 2-sided Original Mode, : 16 lb to 24 lb 1-sided/2-sided Mixed Original Detection Mode Single Automatic Document Feeding Mode: 9-1/4 lb to 53-1/4 lb
Original Size	1-sided/2-sided Original Mode: 11×17L, LegalL, LetterL, LetterC, InvoiceL 2-in-1 Mode: LetterC 1-sided/2-sided Mixed Original Detection Mode: 11×17L, LegalL, LetterL, LetterC
Capacity of Document Feed Tray	LegalL, LetterL, LetterC, InvoiceL: 50 sheets (21-1/4 lb) 11×17, 11×14, 10×14 : 30 sheets (21-1/4 lb)
Copy Productivity	Full-color : 8 copies/min (LetterC) Black : 32 copies/min (LetterC)
Power Source	DC24V supplied from copier
Power Consumption	48W or less
Dimensions	Width : 24 inch Depth : 20-1/4 inch Height : 5 inch (Excluding Document Exit Tray)
Weight	28-1/2 lb

1. Specifications

Large Capacity Cassette C101

Kinds of Paper	Plain paper (16 lb to 24 lb), Recycled paper
Paper Size	A4C, Letter C
Capacity	1,100 sheets (20 lb)
Power Source	Supplied from copier
Power Consumption	30W or less
Dimensions	Width : 14 Depth : 17-1/2 Height : 11-1/2
Weight	23-1/2 lb

10 Bin Sorter S-105

No. of Bins	11 Bins Sort Bins: 10 (From 2nd Bin to 11th Bin)
Modes	Non-Sort Mode, Sort Mode, Group Mode
Kinds of Paper	Non-Sort Mode: Plain paper (16 lb to 24 lb) Special paper (Thick paper, OHP films) Sort Mode, Group Mode: Plain paper (16 lb to 24 lb)
Paper Size	Non-Sort Mode: 12×18L, 11×17L to InvoiceL Sort Mode, Group Mode: 11×17L to InvoiceL
Capacity of Bins	Non-Sort Mode Plain paper: Max 50 sheets (11×17L / 21-1/4 lb paper) Special paper OHP Transparencies : 10 sheets in 1st bin (Max. paper size Letter) Thick paper : 10 sheets in 1st bin Sort Mode, Group Mode Plain paper: 1st bin to 10th bin: 25 sheets/bin (21-1/4 lb) total 250 sheets
Power Source	DC24V supplied from copier
Power Consumption	72W or less
Dimensions	Width : 15-3/4 inch Depth : 22-1/4 inch Height : 16 inch
Weight	34-3/4 lb (Excluding Mounting Brackets)

10 Bin Staple Sorter ST-103

No. of Bins	11 Bins Sort Bins: 10 (From 2nd Bin to 11th Bin)
Modes	Non-Sort Mode, Sort Mode, Sort-and-Staple Mode, Manual Staple Mode
Kinds of Paper	Non-Sort Mode: Plain paper (16 lb to 24 lb), Special paper (Thick paper, OHP films) Sort Mode, Sort-and Staple Mode: Plain paper (16 lb to 24 lb)
Paper Size	Non-Sort Mode : 12×18L, 11×17L to InvoiceL Sort Mode : 11×17L to InvoiceL Sort-and-Staple Mode: 11×17L to LetterC
Capacity of Bins	Non-Sort Mode Plain paper: Max 50 sheets (11×17L / 21-1/4 lb paper) Special paper OHP Transparencies : 10 sheets in 1st bin (Max. paper size Letter) Thick Paper : 10 sheets in 1st bin Sort Mode, Sort-and-Staple Mode Plain paper: 1st bin to 10th bin: 25 sheets/bin (21-1/4 lb) total 250 sheets
Staple Capacity	2 to 25 sheets (21-1/4 lb)
Power Source	DC24V supplied from copier
Power Consumption	72W or less
Dimensions	Width : 15-3/4 inch Depth : 22-1/4 inch Height : 16 inch
Weight	40 lb (Excluding Mounting Brackets)
Accessories	Staple Cartridge, 5,000 staples/cartridge × 1 piece

1. Specifications

Duplex Unit AD-7

Kinds of Paper	Plain paper: 16 lb to 24 lb
Copy Paper Size	11×17L to InvoiceL
Capacity	<p>(When the Automatic Document Feeder is used)</p> <p>1-sided Original: Up to 99 copies (LetterC, InvoiceL) Up to 2 copies (11×17L, LegalL, LetterL)</p> <p>2-sided Original: Up to 2 copies (LetterC, InvoiceL) Up to 2 copies (11×17L, LegalL, LetterL)</p> <p>(When the Automatic Document Feeder is not used)</p> <p>1-sided/2-sided Original: Up to 2 copies (LetterC, InvoiceL) 1 copy (11×17L, LegalL, LetterL)</p> <p>Book Original: 99 copy</p>
Power Source	DC24V, ±5% supplied from copier
Power Consumption	30W or less
Dimensions	Width : 4-3/4 inch Depth : 21 inch Height : 31-1/2 inch
Weight	15-1/2 lb (Excluding Mounting Brackets)

2. Care of the Copier

Cleaning

(Turn OFF the Power Switch of the copier when cleaning.)

Housing Cover

Wipe the surface of the Housing Cover clean with a soft cloth dampened with mild home detergent.

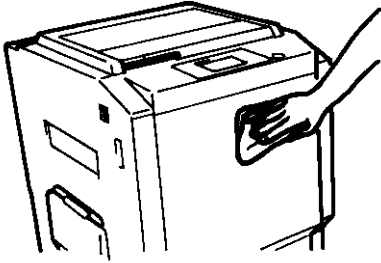

1179O062AA

Document Transport Belt

1 Wipe the surface of the Document Transport Belt clean with a soft cloth dampened with mild home detergent.

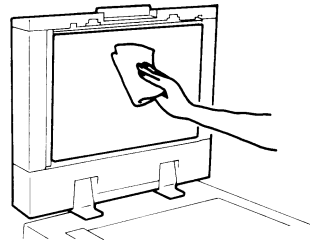

1139O1910A

Control Panel

Wipe the surface of the Control Panel clean with a soft, dry cloth.

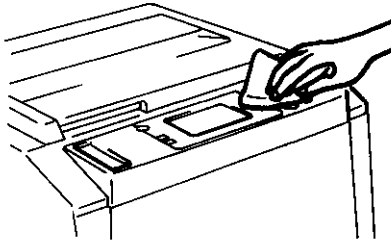

1179O063AA

2 Hold the Document Transport Belt at both edges and pull it to the left to expose a fresh surface.

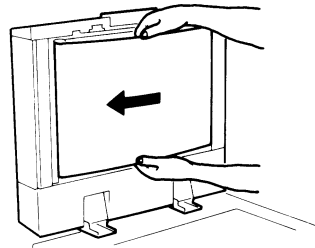

1139O1920A

3 Wipe the fresh surface clean using the soft cloth dampened with mild home detergent. Repeat these steps until the entire surface of the Belt is wiped clean.

NOTE

NEVER use a glass cleaner or any other detergent to avoid damage to the control panel keys and Touch Panel.

Original Glass

Wipe the surface of the Original Glass clean with a soft, dry cloth.

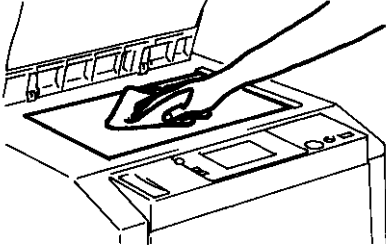

1179O064AA

Front Door

Wipe the inside of the Front Door clean with a soft, dry cloth.

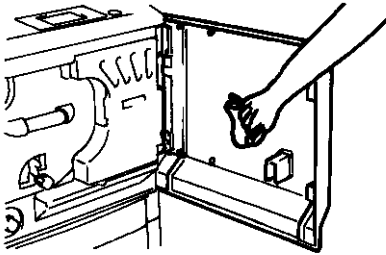

1179O065AA

Precautions for Setting the Color Adjust Function

		Function Set Last		Basic							Professional						Original Image Type
		Red	Green	Blue	Sharpness	Brightness	Contrast	Saturation	Portrait	Hue	Saturation	Brightness	Sharpness	Density	Contrast	Color Balance	
	Function Set First		Red	Green	Blue	Sharpness	Brightness	Contrast	Saturation	Portrait	Hue	Saturation	Brightness	Sharpness	Density	Contrast	Color Balance
	Basic	Red		◆	◆	○	○	○	○	○	○	○	○	○	○	○	○
Green		◆		◆	○	○	○	○	○	○	○	○	○	○	◆	○	○
Blue		◆	◆		○	○	○	○	○	○	○	○	○	○	◆	○	○
Sharpness		○	○	○		○	○	○	○	○	○	○	○	◆	○	○	○
Brightness		○	○	○	○		◆	○	○	○	○	○	◆	○	○	◆	○
Contrast		○	○	○	○	◆		○	○	○	○	○	◆	○	○	◆	○
Saturation		○	○	○	○	○	○		○	○	○	◆	○	○	○	○	○
Portrait		○	○	○	○	○	○	○		◆	○	○	○	○	○	○	○
Professional	Hue	○	○	○	○	○	○	○		◆	○	○	○	○	○	○	○
	Saturation	○	○	○	○	○	○	◆	○	○		○	○	○	○	○	○
	Brightness	○	○	○	○	◆	◆	○	○	○	○		○	○	○	◆	○
	Sharpness	○	○	○	◆	○	○	○	○	○	○	○		○	○	○	○
	Density	◆	◆	◆	○	○	○	○	○	○	○	○	○		○	○	○
	Contrast	○	○	○	○	◆	◆	○	○	○	○	○	◆	○	○	○	○
	Color Balance	○	○	○	○	○	○	○	○	○	○	○	○	○	○	○	○
Original Image Type		○	○	○	○	○	○	○	○	○	○	○	○	○	○	○	○

- : The functions can be combined.
- : The functions can be combined (though a miscopy could result).
- ◇ : The functions cannot be combined. (The function set first takes precedence.)
- ◆ : The functions cannot be combined. (The function set last takes precedence.)
- A : Cover requires that paper be loaded in the Manual Bypass Table, meaning that it does not allow manual bypass copying.
- B : OHP Interleaving requires that OHP transparencies be loaded in the Manual Bypass Table, meaning that it does not allow manual bypass copying.
- C : In OHP Interleaving, Non-Sort is automatically selected.
- D : In Monotone, Black or Black of Color Separation, only the following Color Adjust functions can be adjusted: Sharpness, Brightness, and Contrast under “Basic” and Sharpness, Density, Contrast, and Color Balance (for Monotone only) under “Professional.”
- E : These functions cannot be set last (as the display does not provide keys for setting if you go the other way around.)
- F : The function set last takes precedence between “Image Density” of “Density” and “Red,” “Green,” “Blue,” or “Density” of “Color Adjust.”
- G : The zoom ratio can be set only through “Zoom Ratio (%).”
- H : Setting is possible, but the function set first takes precedence.
- I : Setting is possible, but the function set last takes precedence.
- J : Only CF Paper can be used for 2-sided copies.

4. Description of Paper Size and Zoom Ratio Table

Description of Paper Size and Zoom Ratio Table

Paper Size

Name	Size (Metric)	Size (Inch)
A3	297 mm × 420 mm	11-3/4 × 16-1/2
B4	257 mm × 364 mm	10 × 14-1/4
A4	210 mm × 297 mm	8-1/4 × 11-3/4
B5	182 mm × 257 mm	7-1/4 × 10
A5	148 mm × 210 mm	5-3/4 × 8-1/4
B6	128 mm × 182 mm	5 × 7-1/4
A6	105 mm × 148 mm	4-1/4 × 5-3/4
POST CARD	100 mm × 148 mm	4 × 5-3/4

Name	Size (Inch)	Size (Metric)
LEDGER	11 × 17	279 mm × 432 mm
11 × 14	11 × 14	279 mm × 356 mm
COMPUTER	10-1/8 × 14	257 mm × 356 mm
10 × 14	10 × 14	254 mm × 356 mm
9-1/4 × 14	9-1/4 × 14	236 mm × 356 mm
LEGAL	8-1/2 × 14	216 mm × 356 mm
FOOLSCAP	GOVERNMENT LEGAL	8-1/2 × 13
FOOLSCAP		8 × 13
FOOLSCAP		8-2/3 × 13
FOOLSCAP	FOLIO	8-1/4 × 13
8-1/4 × 11-3/4		8-1/4 × 11-3/4
LETTER		8-1/2 × 11
GOVERNMENT LETTER		8 × 10-1/2
QUARTO		8 × 10
STATEMENT	INVOICE	5-1/2 × 8-1/2
		140 mm × 216 mm

Zoom Ratio Table (Original Size to Copy Paper Size)

Original Size	Metric Areas	
	Copy Paper Size	Zoom Ratio
A3 297 × 420 mm 11-3/4 × 16-1/2	A4	×0.707
	A5	×0.500
	B4	×0.866
	B5	×0.610
	A5	×0.707
A4 210 × 297 mm 8-1/4 × 11-3/4	A6	×0.500
	B5	×0.866
	B6	×0.610
	A3	×1.414
	B4	×1.224
	A6	×0.707
A5 148 × 210 mm 5-3/4 × 8-1/4	B6	×0.866
	A4	×1.414
	A3	×2.000
	B4	×1.733
	B5	×1.224
A6 105 × 148 mm 4-1/4 × 5-3/4	A4	×2.000
	A5	×1.414
	B5	×1.733
	B6	×1.224
B4 257 × 364 mm 10 × 14-1/4	A4	×0.816
	A5	×0.577
	B5	×0.707
	B6	×0.500
B5 182 × 257 mm 7-1/4 × 10	A3	×1.154
	A5	×0.816
	A6	×0.577
	B6	×0.707
	A3	×1.640
B6 128 × 182 mm 5 × 7-1/4	A4	×1.154
	B4	×2.000
	B5	×1.414
	A6	×0.816
	A4	×1.640

Original Size	Inch Areas	
	Copy Paper Size	Zoom Ratio
11 × 17 279.4 × 431.8 mm	11 × 14	×0.823
	Legal	×0.772
	Foolscap	×0.764
	Letter	×0.647
	Invoice	×0.500
11 × 15 279.4 × 381 mm	11 × 14	×0.933
	Legal	×0.772
	Foolscap	×0.772
	Letter	×0.733
11 × 14 279.4 × 355.6 mm	Invoice	×0.500
	Legal	×0.772
	Foolscap	×0.772
	Letter	×0.772
Legal 8-1/2 × 14 215.9 × 355.6 mm	Invoice	×0.500
	Foolscap	×0.928
	Letter	×0.785
	Invoice	×0.607
Foolscap 8-1/2 × 13 215.9 × 330.2 mm	11 × 17	×1.214
	Letter	×0.846
	Invoice	×0.647
Letter 8-1/2 × 11 215.9 × 279.4 mm	11 × 17	×1.294
	11 × 14	×1.272
	Invoice	×0.647
Invoice 5-1/2 × 8-1/2 139.7 × 215.9 mm	11 × 17	×2.000
	11 × 14	×1.647
	Legal	×1.545
	Foolscap	×1.529
	Letter	×1.294

Zoom Ratio = Copy Paper Size ÷ Original Size

1 inch = 25.4 mm
1 mm = 0.0394 inch

5. Index

Index

- 1 ► (2in1) Copy p. 3-20
 - 1 ► 1 Copy p. 3-19
 - 1 ► 2 Copy p. 3-19
 - 1 ► 2 (2in1) Copy p. 3-20
 - 1-Sided Book p. 3-20
 - 2 ► 1 Copy p. 3-19
 - 2 ► 2 Copy p. 3-20
 - 2-Sided Book p. 3-20
- A**
- Access Mode Key pp. 2-6, 2-11
 - Access Number p. 2-11
 - ACS Judgment Level Adjust p. 5-19
 - Administrator Code Number pp. 5-3, 5-4, 5-5
 - Auto Color Key p. 2-5
 - Auto Color Mode p. 3-1
 - Auto Copy Start Function p. 2-10
 - Auto Dual Function p. 3-29
 - Auto Exposure p. 3-17
 - Auto Original Count Mode p. 3-22
 - Auto Panel Reset Function p. 2-10
 - Auto Paper p. 3-9
 - Auto Reset p. 5-19
 - Auto Size p. 3-13
 - Auto Tray Switching p. 3-10
- B**
- Background Color p. 4-18
 - Basic Adjustment Items p. 3-30
 - Black Key p. 2-5
 - Black Mode p. 3-1
 - Blue Component p. 3-30
 - Book Mode p. 3-20
 - Brightness pp. 3-30, 4-11
- C**
- Calling Up a Job p. 5-18
 - Cleaning p. 8-7
 - Clear Key p. 2-6, 3-2
 - Color Adjust Mode (Basic) p. 3-30
 - Color Adjust Mode (Professional) p. 4-11
 - Color Balance p. 4-11
 - Color Mode p. 3-1
 - Color Separation p. 4-20
 - Confirmation Beep p. 5-19
 - Contrast pp. 3-30, 4-11
 - Contrast (Touch Panel) p. 2-5
 - Control Panel Keys p. 2-5
 - Copy Paper Size p. 3-9
 - Copy Paper Size and Zoom Ratio Table p. 8-11
 - Copy Track Functions p. 5-3
 - Count Data p. 5-2
 - Cover Sheet p. 4-9
 - Custom 2in1 p. 5-19
- D**
- Default Settings p. 5-1
 - Density pp. 3-17, 4-11
 - Digital Art Functions p. 4-15
 - Display Contrast Control Knob p. 2-5
 - Dummy Rotation p. 5-13
- E**
- Energy Saver Key pp. 2-6, 2-10
 - Energy Saver Mode p. 2-10, 5-19
 - Entering the Access Number p. 2-11
- F**
- File Margin p. 4-3
 - Finishing Modes p. 3-25
 - Flesh Tone p. 3-30
 - Frame Erase p. 4-1
 - Full Color Key p. 2-5
 - Full Color Mode p. 3-1
 - Function Combination Matrix p. 8-9
- G**
- Gamma-Curve Limitation p. 5-14
 - Green Component p. 3-30
 - Group p. 3-26
- H**
- Hue p. 4-11
- I**
- Image Centering p. 5-21
 - Image Repeat p. 4-23
 - Initial Mode p. 2-9
 - Input ► Output Mode p. 3-19
 - Intelligent Sort p. 5-19

5. Index

Interrupt Key pp. 2-6, 2-10
 Interrupt Mode p. 2-10

J

Job Memory Input p. 5-17
 Job Recall Key pp. 2-5, 5-18

K

Key Counter p. 5-19

L

Language p. 5-19
 Loading Paper p. 6-1

M

Manual Bypass Copying p. 3-11
 Manual Exposure p. 3-17
 Manual Staple p. 3-26
 Meter Count p. 5-2
 Mirror Image p. 4-29
 Misfeed Clearing Procedure p. 6-7
 Mixed Original Detection Mode p. 3-23
 Monotone p. 4-17
 Multi-Page Enlargement p. 4-25

N

Neg.-Pos. Reverse p. 4-19
 Non-Sort p. 3-25

O

OHP Interleaving p. 4-6
 Original ► Copy Types p. 3-19
 Original Image Type p. 3-32

P

Panel Reset Key pp. 2-6, 2-10
 Panel Resetting p. 2-10
 Paper Size List p. 8-11
 Photo Mode p. 3-33
 Photo Mode Key pp. 2-6, 3-33
 Placing Originals p. 3-3
 Portrait p. 3-30
 Positioning Sheet pp. 8-2, 8-9
 Postcard p. 4-31

R

Red Component p. 3-30
 Replacing the Staple Cartridge p. 6-5
 Replenishing the Fuser Oil p. 6-14
 Replenishing Toner p. 6-3

S

Sample Copy p. 3-31
 Saturation pp. 3-30, 4-11
 Scanner Address Input p. 5-22
 Selecting the Ratio p. 3-13
 Setting the number of copies p. 3-2
 Sharpness pp. 3-30, 4-11
 Sort p. 3-25
 Sort-and-Staple p. 3-25
 Start Key pp. 2-5, 3-2
 Starting the Copy Cycle p. 3-2
 Stop Key pp. 2-6, 3-2
 Stopping the Copy Cycle p. 3-2
 Storing and Calling Jobs p. 5-17
 System Overview p. 2-1

T

Thick 2 Duplex p. 5-15
 Touch Panel p. 2-7
 Turning ON and OFF p. 2-9

U

User's Choice p. 5-19
 Using Manual Staple Mode p. 3-27
 Using the Copier as a Printer p. 2-12
 Utility Key pp. 2-5, 5-1

W

What does each Message mean? p. 6-18

X

X/Y Zoom p. 4-21

Z

Zoom Ratio p. 3-13
 Zoom Ratio Table p. 8-11

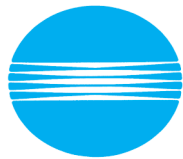

MINOLTA

***Copyright
2000 MINOLTA CO., LTD.***

The information contained in this manual is
subject to change without notice to
incorporate improvements made on the
product or products the manual covers.

Minolta Co., Ltd.

Image Information Products Marketing Headquarters
3-13, 2-Chome, Azuchi-Machi, Chuo-ku, Osaka 541-8556, Japan