

Motherboard

4S651M/4S651MN

1. 4S651M/4S651MN Specification	4
1.1 Introduction	4
1.2 Package Contents	5
1.3 Specifications and Features	6
CPU Processor	6
Chipset	6
VGA	6
PCI	6
Integrated LAN Controller (for 4S651MN only)	6
Universal Serial Bus	6
Award BIOS	7
ATA 100/133 On Board	7
PCI-Based AC 97 Digital Audio Codec	7
AGP 4X On Board	7
CNR Slot On Board	7
1.4 4S651M/4S651MN Layout Diagram	8
1.5 CPU and CPU Fan Installation	10
1.5.1 CPU Installation with Socket 478	10
1.5.2 CPU Fan Installation with P4 Fan Base	11
1.6 DDR SDRAM Installation	12
1.7 Connectors & Jumpers Setting	13
1.7.1 Back Panel I/O Connectors	13

1.7.1.1 PS/2 Mouse / Keyboard CONN.	13
1.7.1.2 USB Ports	13
1.7.1.3 Serial Interface Port: COM1	14
1.7.1.4 Parallel Interface Port	14
1.7.1.5 Audio Port Connectors	14
1.7.1.6 VGA Connector	14
1.7.1.7 LAN Connector (4S651MN only): RJ45	15
1.7.2 ATX Main Power Connectors: PW1/PW2	16
1.7.3 Floppy Disk Connector: FDD	17
1.7.4 Hard Disk Connectors: IDE1/IDE2	17
1.7.5 Fan Connectors: FAN1/2/3	17
1.7.6 Audio-In Connectors: CD1/AUX1	18
1.7.7 Wake On LAN Connector: WOL1	18
1.7.8 USB Pin Header: USB6	19
1.7.9 Front Panel Connectors: PANEL1	20
1.7.10 Modem Connector: JP4	21
1.7.11 IR infrared module: IR1 Connector	22
1.7.12 Front Audio Connector: F-J1	22
1.7.13 AGP4X : AGP4X Slot	23
1.7.14 Modem/Sound Card: CNR Slot	23
1.7.15 CMOS Function Selector: JP3	24
1.7.16 Keyboard & USB5/RJUSB1 Wake-up: Jp11	24
1.7.17 USB6 Wake-up Selector: Jp10	25
1.7.18 CNR Slot Select: Jp1	25
2. BIOS Setup	26
2.1 BIOS Support	26
2.2 Main Menu	29
2.3 Standard CMOS Features	32
2.4 Advanced BIOS Features	36

2.5 Advanced Chipset Features	40
2.6 Integrated Peripherals	43
2.7 Power Management Setup	48
2.8 PnP/PCI Configurations	51
2.9 PC Health Status	54
2.10 Frequency/Voltage Control.....	55
2.11 Load Fail-Safe Defaults	56
2.12 Load Optimized Defaults	57
2.13 Set Supervisor / User Password	58
2.14 Save & Exit Setup	59
2.15 Exit Without Saving	60
3. Drivers & Utilities	61
3.1 Auto-run Menu	61
3.2 Installing SiS VGA Driver	63
3.3 LAN Driver (for 4S651MN only)	65
3.4 Installing Audio Driver	66
3.4.1 Installing 6-channel Driver	66
3.4.2 Verifying 6-channel Driver	66
3.5 Installing USB 2.0 Driver	68
3.7 Installing Modem Driver (optional)	70
Appendices	71
Motherboard Compatibility Test.....	71
(1) CPU Compatibility Test	71
(2) AGP Display Card Compatibility Test	72
(3) Memory Compatibility Test	73

Chapter 1

4S651M/4S651MN

1. 4S651M/4S651MN Specification

1.1 Introduction

The 4S651M/4S651MN motherboard is an integration of Intel P4 CPUs in Socket-478 packaging and the North Bridge SiS650GX supporting 533/400 MHz Front Side Bus.

North Bridge SiS650GX on board also supports DDR 333/266/200 DRAMs, integrated VGA and the integrated AGP 4X Interface, while the South Bridge SiS962L provides stable supports of ULTRAATA 133/100, 6-channel Audio playback, LPC Super I/O, USB 2.0/1.1 interface, PCI interface as well as integrated 10/100Mbit Fast Ethernet LAN Controller (on 4S651MN).

The resulting architecture will provide an ideal multi-task environment to support operating systems such as MS-DOS, Windows, WindowsNT, Windows ME, Windows 2000, Novell, OS/2, Windows 95/98, Windows 98SE, Windows XP, UNIX, Liunx, SCO UNIX etc. This user-friendly manual is to describe in detail how to install, configure and use this motherboard with drivers and BIOS setup illustrations.

This manual is a general reference of the first release of this motherboard which is subject to update without notice. If any difference is found between this manual and the motherboard you are using, please refer to the Web Site for latest update.

1.2 Package Contents

- ◆HDD Cable.
- ◆FDD Cable.
- ◆Flash Memory with BIOS
- ◆Fully Setup Driver CD with built in utilities.
- ◆User Manual.
- ◆I/O Shielding.

1.3 Specifications and Features

CPU Processor

- | Support 533/400MHz System Interface speed.
- | Single Socket 478 for Intel P4™ 1.5 to 2.8GHz or higher* (Northwood Processor).
- | Support Intel Netburst™ Micro-architecture.

* The higher frequency CPU should be compatible with Intel CPU specification as well as the motherboard latest BIOS version released on the web site.

Chipset

- | SiS650GX North Bridge, supporting 533/400MHz FSB and AGP 2.0 interface
- | SiS962L South Bridge.

VGA

- | VGA Interface built in
- | 1x 15-pin VGA connector built in for VGA display

PCI

- | Supports 33MHz PCI Bus speed.
- | 3 x PCI slots on board

Integrated LAN Controller (for 4S651MN only)

- | Supporting 10/100Mbit Fast Ethernet LAN
- | Supporting 1xRJ45 Connector (for 4S651MN motherboard only)

Universal Serial Bus

- | Supporting 4 on-board Universal Serial Bus(USB) Ports and 2 external Universal serial Bus(USB) Ports.
- | Supporting USB 2.0/1.1

Award BIOS

- | Supporting Plug & Play specification which detects the peripheral devices and expansion cards automatically
- | Supporting CD-ROM, SCSI, LAN BOOT, Temperature sensor, LAN, Alarm Bus CLK setup
- | Supporting Desktop Management Interface (DMI) function for recording mainboard specification

ATA 100/133 On Board

- | Supporting four IDE devices with 2 x IDE connectors
- | Supporting PIO Mode 5, Master Mode, high performance hard disk drives
- | Dual -channel Ultra DMA 33/66/100/133 Bus Master Mode
- | Supporting IDE interface with CD-ROM
- | Supporting high capacity hard disk drives
- | Supporting LBA mode

PCI-Based AC 97 Digital Audio Codec

- | AC 97 2.2 compatible Codec, 6-channel Audio interface.
- | 18-bit Stereo Full-Duplex Codec with up to 48 KHz sampling rate
- | 4 Analog Line-level Stereo inputs for connection from Line, CD, Video and AUX
- | 2 Analog Line-level Stereo inputs for speakerphone and PC beep

AGP 4X On Board

- | AGP 66MHz, 1.5V for AGP4X graphic card.

CNR Slot On Board

- | CNR(Communication and Network Riser) slot on board, supporting Analog Modem/Multi-channel/Sound card

1.4 4S651M/4S651MN Layout Diagram

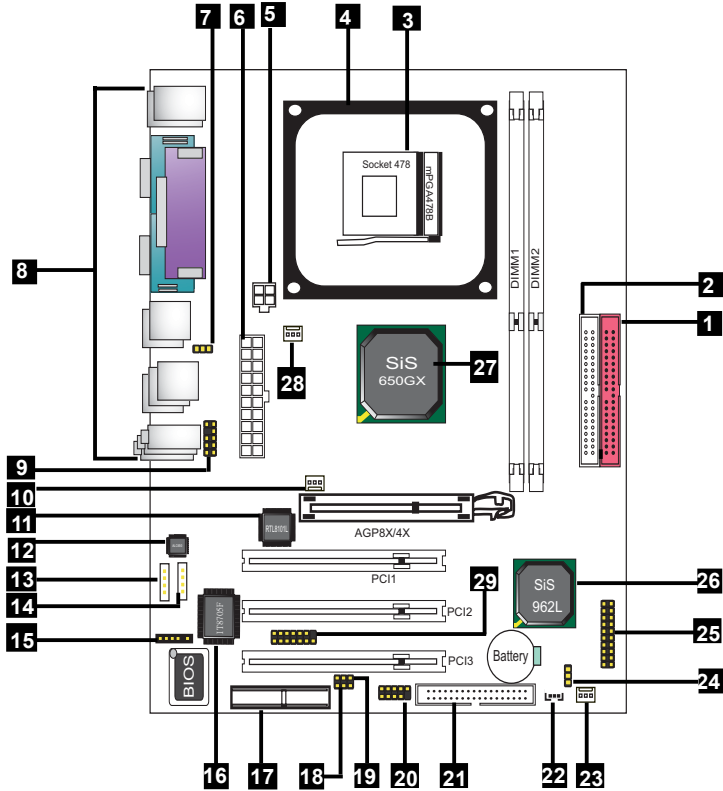

4S651M/4S651MN Component Layout :

- 1. IDE1: IDE Connector**
- 2. IDE2: IDE Connector**
- 3. P4 CPU Socket 478**
- 4. P4 CPU Fan Base**
- 5. +12V Power Connector**
- 6. ATX Main Power Connector**
- 7. JP11: Jumper for Keyboard and USB(USB5/RJUSB1)Wake-up**
- 8. Back Panel: Back Panel I/O Connectors (Mouse, Keyboard, COM1, VGA, Printer, RJ45 (for 4S651MN motherboard only), USB5, RJUSB1, Mic in, Speaker-out, Line-in.**
- 9. F-J1: Front Audio Connector**
- 10. FAN2: Cooling Fan Connector**
- 11. RTL8101L : LAN Controller**
- 12. ALC650: 6-channel AC'97 Audio Codec**
- 13. AUX1: Audio Input Connector**
- 14. CD1: Pin Header for CD Audio-in**
- 15. IR1: Connector for Infrared signal transmission**
- 16. IT8705F: LPC Super I/O Chip**
- 17. CNR1: Communication Slot**
- 18. JP1: Jumper for CNR Slot Select**
- 19. JP10: Jumper for USB6 Wake-up Select**
- 20. USB6: USB Device Pin-header for 2 two USB ports**
- 21. FDC1: Floppy Drive Connector**
- 22. WOL1: Connector for Wake-on-LAN function**
- 23. FAN3: Cooling Fan Connector**
- 24. JP3: Jumper for Clear CMOS Select**
- 25. Panel1: Front Panel Pin-header**
- 26. South Bridge SiS 962L**
- 27. North Bridge SiS 650GX**
- 28. FAN1: Cooling Fan Connector**
- 29. JP4: Modem Card Connector**

1.5 CPU and CPU Fan Installation

This motherboard is designed with Socket 478 for Intel P4™ processors.

1.5.1 CPU Installation with Socket 478

1. Pull the lever sideways away from the socket then raise the lever to a 90-degree angle.
2. Locate Pin 1 in the socket. Pin 1 of CPU is marked by the yellow corner or cut edge on the CPU. Match Pin 1 of Socket 478 and Pin 1 of CPU.
3. Pull up the lever of Socket 478 to let the CPU in and press the lever down to lock the CPU.
4. Make sure that Pin 1 of Socket 478 is matching with Pin 1 of CPU.
5. Make sure that all CPU pins are completely in socket before pressing down the socket lever.

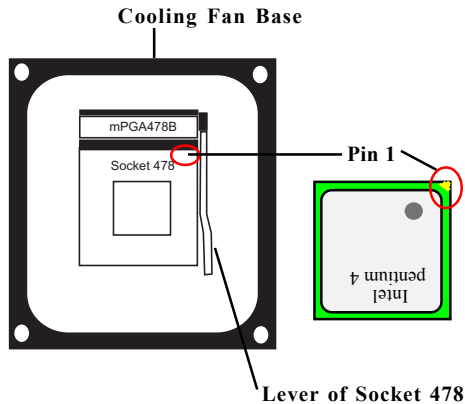

1.5.2 CPU Fan Installation with P4 Fan Base

1. P4 CPU Fan is typically designed with 4 latches and mounted with a thick heatsink. Please do not use other type of CPU fan which cannot match the P4 Fan base on board.
2. Install the P4 CPU fan into the Fan base in such a way that the 4 latches of the CPU Fan match with the 4 Supporters of the CPU Fan Base.
3. Press down the latches to lock CPU Fan to the Fan Base.
4. Then connect the Fan Power Cable to one of the Fan connectors on board.
5. Make sure that the Fan Power Cable is correctly connected to Fan Connector.

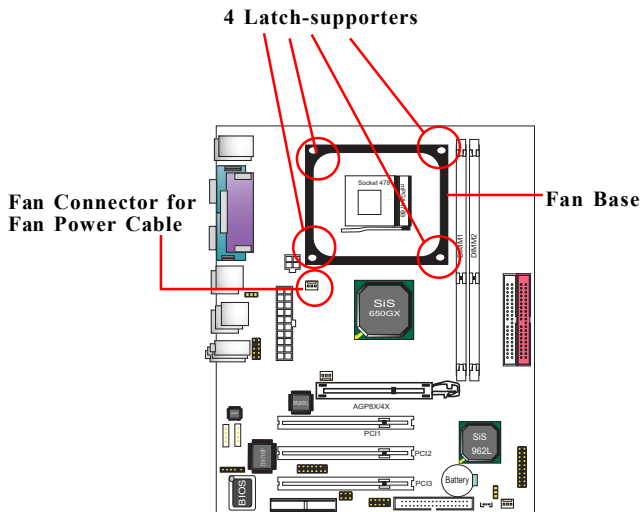

1.6 DDR SDRAM Installation

This motherboard supports a maximized 2GB DDR SDRAM. It provides two 184-pin unbuffered DDR sockets. It supports 64MB to 1GB DDR memory module.

DDR SDRAM Installation Procedures:

1. The DDR socket has a “Plastic Safety Tab” and the DDR memory module has an asymmetrical notch”, so the DDR memory module can only fit into the slot in one direction.
2. Push the tabs out. Insert the DDR memory modules into the socket at a 90-degree angle then push down the module vertically to fit it into place.
3. The Mounting Holes and plastic tabs should fit over the edge and hold the DDR memory modules in place.

Bank	Memory module
DIMM 1	64MB, 128MB, 256MB, 512MB, 1GB
	184 pin, 2.5V DDR SDRAM
DIMM 2	64MB, 128MB, 256MB, 512MB, 1GB
	184 pin, 2.5V DDR SDRAM
Total System Memory (Max 2GB)	

184-pin DDR Module

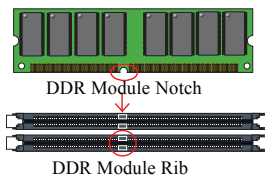

Warning: Be sure to turn off system power whenever to insert or remove a Memory Module. Otherwise, the power will damage the module or even the system.

1.7 Connectors & Jumpers Setting

1.7.1 Back Panel I/O Connectors

This motherboard provides the following back panel connectors:

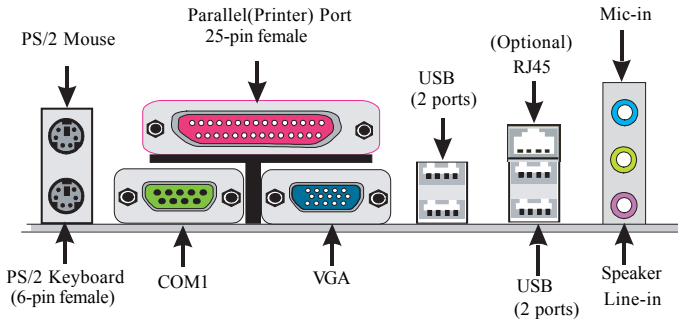

1.7.1.1 PS/2 Mouse / Keyboard CONN.

The motherboard provides a standard PS/2 mouse / Keyboard mini DIN connector for attaching a PS/2 mouse. You can plug a PS/2 mouse / Keyboard directly into this connector.

1.7.1.2 USB Ports

The motherboard provides a OHCI(Open Host Controller Interface)Universal Serial Bus Roots for attaching USB devices such as a keyboard, mouse and other USB devices. You can plug the USB devices directly into this connector.

1.7.1.3 Serial Interface Port: COM1

The serial interface port is sometimes referred to as an RS-232 port or an asynchronous communication port. Mice, printers, modems and other peripheral devices can be connected to a serial port. The serial port can also be used to connect computer systems together. If you like to transfer the contents of your hard disk to another system, it can be accomplished with serial port.



1.7.1.4 Parallel Interface Port

Unlike serial ports, parallel interface ports have been standardized and should not present any difficulty interfacing peripherals to your system. Sometimes called a Centronics port, the parallel port is almost exclusively used with printers. The parallel port on your system is a 25-pin, DB 25 connector.

1.7.1.5 Audio Port Connectors

Speaker out is a connector for Speakers or Headphones. Line in is used for external CD player, Tape player, or other audio devices. Mic is a connector for the microphones.

1.7.1.6 VGA Connector

15-pin VGA connector is on board for analog display.

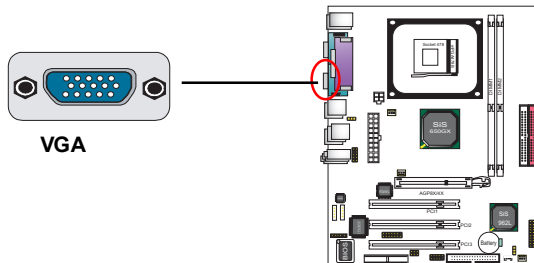

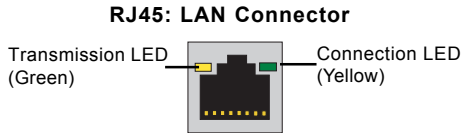

1.7.1.7 LAN Connector (4S651MN only): RJ45

One RJ45 connector is on Back Panel for network connection.



1.7.2 ATX Main Power Connectors: PW1/PW2

This connector supports the power button on-board. Using the ATX power supply, functions such as Modem Ring Wake-Up and Soft Power Off are supported on this motherboard. This power connector supports instant power-on functionality, which means that the system will boot up instantly when the power connector is inserted on the board. ATX 4-pin power connector only support +12V voltage.

	Pin PW1 Signal		Pin PW1 Signal	
	1	GND	2	GND
	3	+12V	4	+12V
	Pin PW2 Signal		Pin PW2 Signal	
	1	3.3V	11	3.3V
	2	3.3V	12	-12V
	3	GND	13	GND
	4	5V	14	PS-ON
	5	GND	15	GND
	6	5V	16	GND
	7	GND	17	GND
	8	PW-OK	18	-5V
	9	5V_SB	19	5V
10	12V	20	5V	

Note:

When you set up P4 power supply, both PW1 and PW2 must be connected to power.

Important:

To switch on your power supply, please make sure:

1. Memory Module is properly installed.
2. Power supply setup is OK.

1.7.3 Floppy Disk Connector: FDD

This connector supports the provided floppy drive ribbon cable. After connecting the single end of the board, connect the two plugs on the other end to the floppy drives.

1.7.4 Hard Disk Connectors: IDE1/IDE2

These connectors are provided with IDE hard disk ribbon cable into the package. After connecting the end of cable with single connector to the mainboard, connect the other two connectors at the other end to your hard disk. If you install two hard disks, you must configure the second drive to Slave mode by setting its jumper settings. BIOS now supports SCSI device or IDE CD-ROM boot up (see "HDD Sequence SCSI/IDE First" & "Boot Sequence" in the BIOS Features Setup of the BIOS SOFTWARE).

1.7.5 Fan Connectors: FAN1/2/3

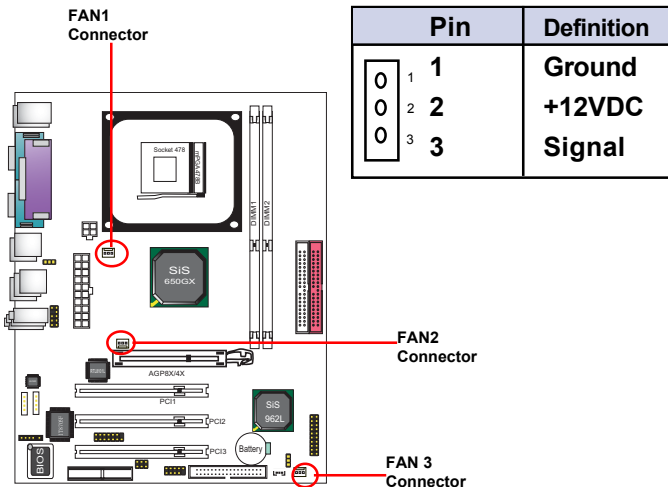

FAN1, FAN2 and FAN3 connectors

1.7.6 Audio-In Connectors: CD1/AUX1

CD1 and AUX1 are the connectors for CD-Audio Input signal. Please connect CD1 to CD-ROM CD-Audio output connector, and connect AUX1 to Wave Audio source.

Pin	CD1	Definition
1		XCDINL
2		XCDGND
3		XCDGND
4		XCDINR

Pin	AUX1	Definition
1		WAV-L
2		GND
3		GND
4		WAV-R

1.7.7 Wake On LAN Connector: WOL1

WOL1 is an Wake On LAN (WOL) connector for transmitting the Ring signal from a PCI LAN card to wake up system. If you use a PCI LAN card for system networking, you can connect this Wake On LAN connector with the PCI LAN card on board for Wake On LAN function.

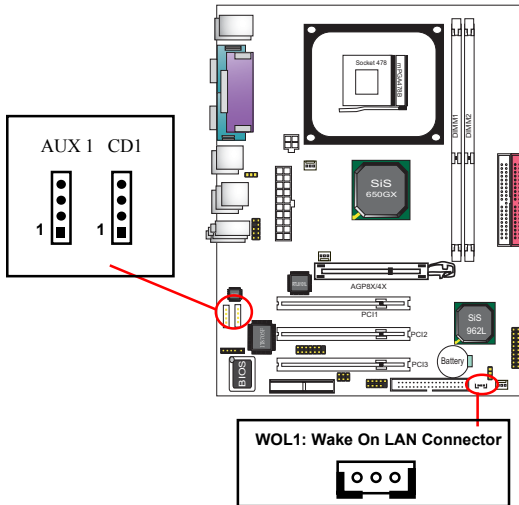

1.7.8 USB Pin Header: USB6

USB6 2x5 Pin Headers for support of external USB ports. Each USB pin header requires a USB cable for expansion of two USB ports. This optional USB cable is available from your motherboard dealer or vendor.

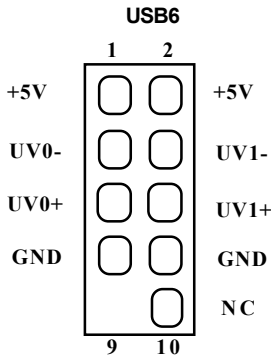
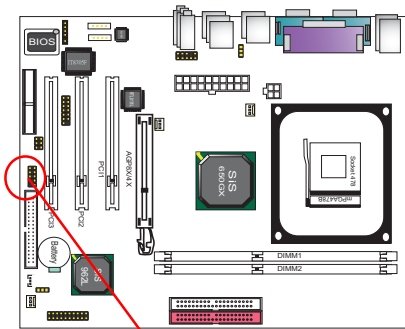

1.7.9 Front Panel Connectors: PANEL1

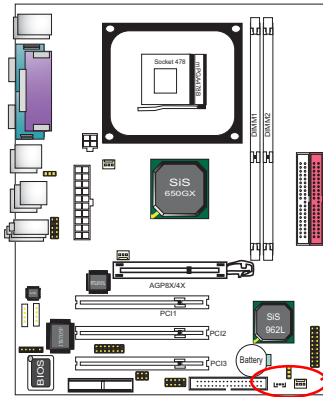

Front Panel Connectors

20		19
18	RST (+)	17
16		15
14	HD LED	13
12		11
10		9
8	SPEAKER	7
6		PW LED
4	(+)	
2	PS SW (+)	1

PSSW

The system power is controlled by a momentary switch connected to this lead. Pushing the button once will switch the system ON.

Power LED Lead (PW_LED)

The system power LED lights when the system power is on.

Speaker Connector (SPEAKER)

The speaker (onboard or offboard) provides error beep code information during the Power Self-Test when the computer cannot use the video interface. The speaker is not connected to the audio subsystem and does not receive output from the audio subsystem.

Hard Drive LED Connector (HD_LED)

This connector supplies power to the cabinet IDE activity LED. Read and write activity by devices connected to the Primary or Secondary IDE connectors will cause the LED to light up.

SMI Suspend Switch Lead (G-BUN)(Disabled)

This allows the user to manually place the system into a suspend mode of Green mode. System activity will be instantly decreased to save electricity and expand the life of certain components when the system is not in use. This 2-pin connector (see the figure) connects to the case-mounted suspend switch. If you do not have a switch for the connector, you may use the "Turbo Switch" instead since it does not have a function. If you want to use this connector, the "Suspend Switch" in the Power Management Setup of the BIOS SOFTWARE section should be enabled.

Reset Switch Lead (RST)

The connector can be connected to a reset switch. Press this reset switch to restart system.

1.7.10 Modem Connector: JP4

JP4 supports one optional AMR-SA94 MODEM card with a MODEM Flat cable.

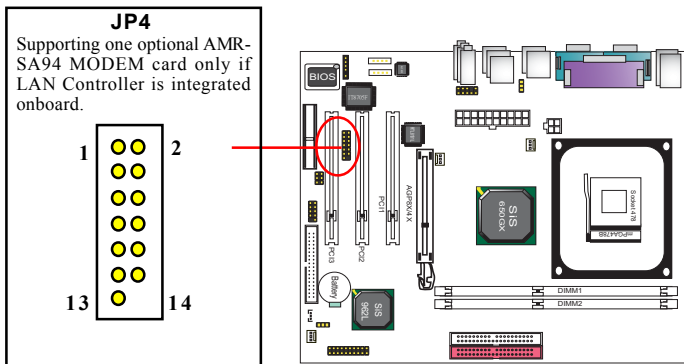

Pin No.	Assignment
Pin 1	GND
Pin3	NC
Pin5	AC_BCK
Pin7	AC_DIN
Pin9	AC_DOUT
Pin11	AC_SYNC
Pin13	AC_RSTB

Pin No.	Assignment
Pin 2	Vcc3
Pin4	Vcc
Pin6	+12V
Pin8	Vdd33
Pin10	NC
Pin12	NC
Pin14	Key

1.7.11 IR infrared module: IR1 Connector

This connector supports the optional wireless transmission and reception infrared module. You must configure the setting through the BIOS setup to use the IR function.

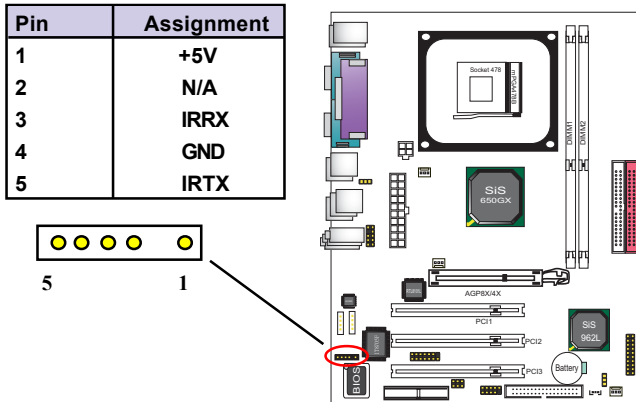

1.7.12 Front Audio Connector: F-J1

F-J1 provides connection to the Front Audio connectors of the Front Audio Panel.

To use this Front Audio Connector, please remove the jumper caps on it and connect it to the Front Audio Panel.

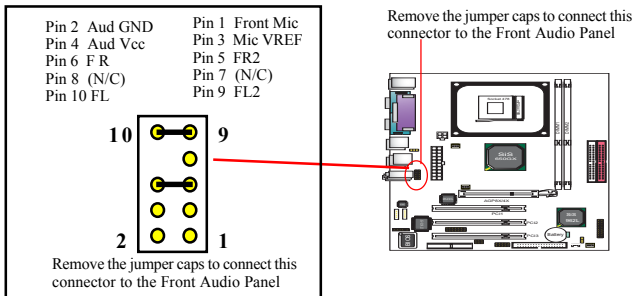

1.7.13 AGP4X : AGP4X Slot

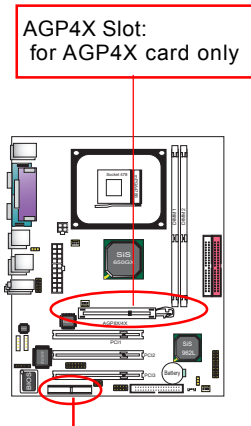

You can install AGP4X card to this AGP4X slot. This slot do not support TV-out display.



CNR Slot:
Use JP1 to set the CNR Slot mode.

1.7.14 Modem/Sound Card: CNR Slot



CNR slot is build on board for add-on Modem/Sound card.
You can set the riser card to Slave/master mode with JP1.

Pin Jp1	Function
1-2 1 	Slave (default)
2-3 1 	Master

1.7.15 CMOS Function Selector: JP3

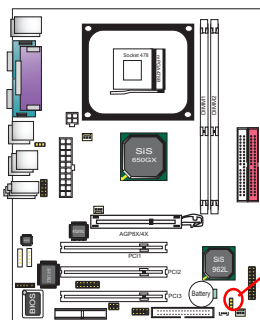
When you have problem with booting system, you may clear CMOS to restore the optimum default BIOS data.





Pin JP43	Function
1-2 closed 	Normal (Default)
2-3 closed 	Clear CMOS

1. Remove the Jumper cap of Jp3 from 1-2.
2. After 1 or two seconds, set Jp5 to 2-3 closed with the jumper cap.
3. After 1 or two seconds, restore the Jp3 to 1-2 closed.
Now, the CMOS RAM has restored to the optimum default setting.

1.7.16 Keyboard & USB5/RJUSB1 Wake-up: Jp11

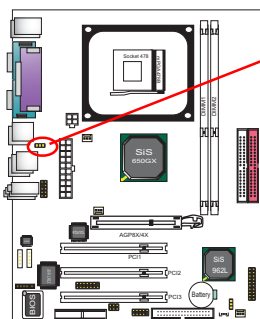
Jp11 is designed to wake up system by PS/2 or USB Keyboard/ Mouse (on USB5 or RJUSB1):





Pin Jp11	Function
2-3 closed 	Enabled
1-2 closed 	Disabled (default)

1.7.17 USB6 Wake-up Selector: Jp10

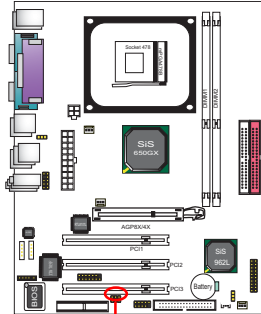
Jp10 is designed to select the USB6 wake up function:



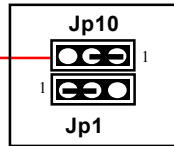

Pin Jp10	Function
2-3 closed 	Enabled
1-2 closed 	Disabled (default)

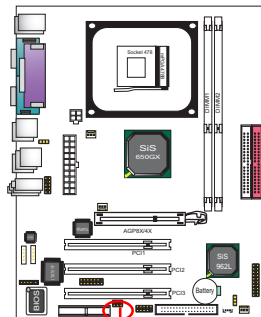

1.7.18 CNR Slot Select: Jp1

Jp1 is designed to select the CNR Slot Mode



Pin Jp1	Function
1-2 	Slave (default)
2-3 	Master

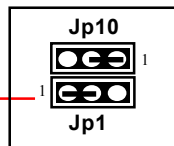

Chapter 2

BIOS Setup

2. BIOS Setup

2.1 BIOS Support

This chapter discusses the Award BIOS Setup program built in the ROM BIOS. The Setup program allows the user to modify the basic system configuration. The modification is then stored in battery-backed RAM so that it can retain the setup information after the power is turned off. The Award BIOS installed in your computer system ROM (Read Only Memory) is a custom version of an industry standard BIOS. The BIOS provides critical low-level support for standard devices such as disk drives and serial and parallel ports. This chapter is intended for guiding you through the process of configuring your system BIOS.

Plug and Play Support

This AWARD BIOS supports the Plug and Play Version 1.0A specification. ESCD(Extended System Configuration Data) write is also supported.

EPA Green PC Support

This AWARD BIOS supports Version 1.03 of the EPA Green PC specification.

PCI Bus Support

This AWARD BIOS also supports Version 2.1 of the Intel PCI (Peripheral Component Interconnect) local bus specification.

APM Support

This AWARD BIOS supports Version 1.1&1.2 of the Advanced Power Management(APM) specification. Power management features are implemented via the System Management Interrupt(SMI). Sleep and Suspend power management modes are supported. Power to the hard disk drives and video monitors can be managed by this AWARD BIOS.

DRAM Support

DDR SDRAMs (Double Data Rate SDRAM) are supported.

CPU Support

This AWARD BIOS supports the Intel P4 Processor.

Setup Menu

In general, you use the arrow keys to highlight items of the Main BIOS Setup Menu, press <Enter> to select, use the <PgUp> and <PgDn> keys to change entries, press <F1> for help and press <Esc> to quit. The following table provides more detail about how to navigate in the Setup program by using the keyboard.

Note:

(BIOS version 1.0 is for reference only. If there is a change in BIOS version, please use the actual version on the BIOS.)

Keystroke	Function
Up arrow	Move to previous item
Down arrow	Move to next item
Left arrow	Move to the item on the left(menu bar)
Right arrow	Move to the item on the right(menu bar)
Esc	Main Menu: Quit without saving changes Submenus: Exit Current page to the next higher level menu
Move Enter	Move to item you desired
PgUp key	Increase the numeric value or make changes
PgDn key	Decrease the numeric value or make changes
+Key	Increase the numeric value or make changes
-Key	Decrease the numeric value or make changes
Esc Key	Main menu-Quit and not save changes into CMOS Status Page Setup Menu and option Page Setup Menu-Exit Current page and return to Main Menu
F1 Key	General help on Setup navigation keys.
F5 Key	Load previous values from CMOS
F6 Key	Load the fail-safe defaults from BIOS default table
F7 Key	Load the optimized defaults
F10 Key	Save all the CMOS changes and exit

Standard CMOS Features

This setup page includes all the items in standard compatible BIOS.

Advanced BIOS Features

This setup page includes all the items of the BIOS special enhanced features.

Advanced Chipset Features

This setup page includes all the items of the Chipset special enhanced features.

Integrated Peripherals

This selection page includes all the items of the IDE hard drive and Programmed Input/Output features.

Power Management Setup

This setup page includes all the items of the power management features.

PnP/PCI Configurations

This setup page includes the user defined or default IRQ Setting.

PC Health Status

This page shows the hardware Monitor information of the system.

Frequency/Voltage Control

This setup page controls the CPU's clock and frequency ratio.

Load Fail-safe Defaults

Use this menu to load the BIOS default values for the minimal/stable performance for your system to operate.

Load Optimized Defaults

These settings are for configuring a workable computer when something is wrong. If you cannot boot the computer successfully, select the BIOS Setup options and try to diagnose the problem after the computer boots. These settings do not provide optional performance.

Set Supervisor/User Password

Change, set, or, disable password. It allows you to limit access to the system and Setup, or just to Setup.

Save & Exit Setup

Save CMOS value changes to CMOS and exit setup.

Exit Without Saving

Abandon all CMOS value changes and exit setup.

2.3 Standard CMOS Features

This main option in the Standard CMOS Setup Menu is divided into 10 fields or items. Each field provides one or more setup choices. Use the arrow keys to highlight the field and then use the <PgUp> or <PgDn> keys to select the value or choice.

Phoenix - AwardBIOS CMOS Setup Utility Standard CMOS Features

Date(mm:dd:yy)	Tue,Jun 6 2002	Item Help
Time (hh:mm:ss)	11:26:10	
IDE Primary Master	None	Menu Level
IDE Primary Slave	None	Change the day, month,year and century.
IDE Secondary Master	None	
IDE Secondary Master	None	
IDE Secondary Master	None	
Drive A	1.44M,3.5 in	
Drive B	None	
Floppy 3	Disabled	
Video	EGA/VGA	
Halt On	All,But Keyboard	
Base Memory	640K	
Extended Memory	65472K	
Total	1024K	

←→↑↓: Move Enter:Select +/-/PU/PD:Value F10:Save ESC:Exit F1:General Help
F5:Previous Values F6:Fail-Safe Defaults F7:Optimized Defaults

Main Menu Selections

Item	Options	Description
Date (mm : dd :yy)	Month Day Year	Set the system,date. Note that the 'Day' automatically changes when you set the data.
Time (hh : mm : SS)	Hour Minute Second	Select the hour, minute and second of the time.
IDE Primary Master	Options are in its sub menu.	Press<Enter> to enter sub menu.
IDE Primary/ Slave	Options are in its sub menu.	Press<Enter> to enter sub menu.
IDE Second- ary Master	Options are in its sub menu.	Press<Enter> to enter sub menu.
IDE Second- ary Slave	Options are in its sub menu.	Press<Enter> to enter sub menu
Drive A Drive B	None 360K,5.25in, 1.2M,5.25in 720K,3.5M 1.44M,3.5in 2.88M,3.5in	Select the type of floppy disk drive installed in your system.
Floppy 3 Mode Support	Disabled Driver A Driver B Both	Disable or support the 3rd floppy mode in Drive A, or Drive B or both.
Video	EGA/VGA CGA 40 CGA 80 MONO	Select the default video device.

Item	Options	Description
Halt On	All Errors No Errors All, but Keyboard All, but Diskette All, but Disk/Key	Select the situation in which you want the BIOS to stop the POST process and notify.
Base Memory	(640K)	The amount of conventional memory detected during boot up.
Extended Memory	(65472K)	The amount of conventional memory detected during boot up.
Total Memory	(1024K)	The total memory available in system.

IDE Primary(Master/Slave)/Secondary(Master/Slave)

Press Enter on these items to show the following sub-menu:

Primary Master/Secondary

IDE HDD Auto-Detection	Press Enter	Item Help
IDE Primary Master	Auto	Menu Level
Access Mode	Auto	
Capacity	13022MB	
Cylinder	25232	
Head	16	
Precomp	0	
Landing Zone	25231	
Sector	61	

←→↑↓: Move Enter:Select +/-/PU/PD:Value F10:Save ESC:Exit F1:General Help
F5:Previous Values F6:Fail-Safe Defaults F7:Optimized Defaults

IDE HDD Auto-Detection

Press Enter on this item to let BIOS auto-detect your Hard Disk and show all the Primary Hard Disk Parameters (Capacity, Cylinder, Head, Precomp, Landing Zone, Sector) on the menu.

IDE Primary(Master/Slave)/Secondary(Master/Slave)

This item allows you to detect the Hard Disk in 3 ways.

- The Choices: Auto: BIOS Auto-detect HDD;
- None: No Hard Disk detected;
- Manual: Manually detect HDD

Access Mode

This item allows you to select the Access mode to the Hard Disk..

The Choices:

- CHS: Select the Cylinder, Head, Sector addressing mode to access Hard Disk;
- LBA: Select the Logical Block Addressing mode to access Hard Disk.
- Large: Select Large Mode to access Hard Disk;
- Auto: Allow BIOS to auto-access Hard Disk;

Capacity

Showing the capacity of Hard Disk in MB.

Cylinder

Showing the number of cylinder in the Hard Disk.

Head

Showing the number of heads in the Hard Disk.

Precomp

The number of Pre-compensation.

Landing Zone

Number of Landing zone in the Hard Disk.

Sector

The number of Sector in the Hard Disk.

2.4 Advanced BIOS Features

Phoenix - AwardBIOS CMOS Setup Utility Advanced BIOS Features

Virus Warning	Disabled	Item Help
CPU L1 & L2 Cache	Enabled	
Quick Power On Self Test	Enabled	
First Boot Device	Floppy	
Second Boot Device	HDD-0	
Third Boot Device	CD-ROM	
Boot Other Device	Enabled	
Swap Floppy Drive	Disabled	
Boot Up Floppy Seek	Disabled	
Boot Up NumLock Status	On	
Gate A20 Option	Fast	
Typematic Rate Setting	Disabled	
X Typematic Rate (Chars/Sec)	6	
X Typematic Delay (Msec)	250	
Security Option	Setup	
OS Select For DRAM >64MB	Non-OS2	
HDD S.M.A.R.T. Capability	Disabled	
Video BIOS Shadow	Enabled	
EPA / (H/W Monitor) Show	H/W Monitor	

←→↑↓: Move Enter:Select +/-/PU/PD:Value F10:Save ESC:Exit F1:General Help
F5:Previous Values F6:Fail-Safe Defaults F7:Optimized Defaults

Virus Warning

This option allows you to choose the VIRUS Warning feature for IDE Hard Disk boot sector protection. If this function is enabled and someone attempts to write data into this area, BIOS will show a warning message on screen and alarm beep.

The Choices:

Disabled; Enabled.

CPU L1 & L2 Cache

These fields allow you to Enable or Disable the CPU's L1 (Internal) / L2 (External) cache to provide better performance.

The choices:

Enabled; Disabled

Quick Power On Self Test

This category speeds up Power on self-Test (POST) after you power up the computer. If it is set to Enabled, BIOS will shorten or skip some check items during POST.

The choices:

Enabled; Disabled

First/Secondary/Third Boot Device

This BIOS attempts to load the operating system from the devices in the sequence selected in these items.

The Choices:

Floppy, LS120, HDD-0, SCSI, CDROM, HDD-1, HDD-2, HDD-3, ZIP100, LAN, USB-HDD, USB-Zip, USB-CDROM, USB-HDD, Disabled.

Boot Other Device

Allows user to set booting from other devices.

The Choices:

Enabled, Disabled.

Swap Floppy Drive

If the system has two floppy drives, you can swap the logical drive name assignments.

The Choices:

Disabled, Enabled.

Boot Up Floppy Seek

If enabled, this item allows BIOS to test floppy drives to determine whether they have 40 or 80 tracks.

The Choices:

Disabled, Enabled.

Boot Up NumLock Status

Select power on state for Numlock..

The Choices

On : Numpad is number keys;

Off: Numpad is arrow keys;

Gate A20 Option

Select if chipset or keyboard controller should control Gate A20.

The choices:

Normal: A pin in the keyboard controller controls Gate A20.

Fast : Lets chipset control Gate A20.

Typematic Rate Setting

Allows user to adjust the key stroke repeat rate.

The choices:

Enabled: Enable this option to adjust the keystroke repeat rate;

Disabled: Disabled

Typematic Rate (Char/Sec)

Range between 6 and 30 characters per second. This option controls the speed of repeating keystrokes.

Typematic Delay (Msec)

This option sets the time interval for displaying the first and the second characters.

The Choices: 250; 500; 750; 1000

Security Option

This category allows you to determine whether to use password access the system and Setup, or just Setup.

The choices:

System: To access system and BIOS Setup with correct password;

Setup: To access BIOS Setup with correct password.

OS Select For DRAM >64MB

Select the operating system that is running with greater than 64MB of RAM on the system.

The Choices: Non-OS2, OS2.

HDDS.M.A.R.T.Capability

Allows user to choose the Self-monitoring Analysis and Reporting Technology for Hard Disk Drive.

The choices: Disabled; Enabled

Video BIOS Shadow

Use this item to enable/disable the Video BIOS Shadow function

The choices: Enabled; Disabled

EPA/(H/W Monitor) Show

Use this item to enable/disable the Environmental Protection Association (EPA)/ Hardware Monitor) logo on initiating screen..

The choices: H/W Monitor; EPA Logo

2.5 Advanced Chipset Features

This section allows you to configure the system based features of the installed chipset. This chipset manages bus speeds and access to system memory resources, such as DRAM and external cache. It also coordinates communications of the PCI bus. It must be stated that these items should never be altered. The default settings are set up to provide the best operating conditions for your system. The time you might need to make any changes would be if you discover that data is lost while using your system.

Phoenix - AwardBIOS CMOS Setup Utility Advanced Chipset Features

		Item Help
▶ DRAM Clock/Timing Control	Press Enter	
System Performance	Normal Mode	
CAS Latency Setting	2.5T	
DRAM Addr/Cmd Rate	Auto	
Prefetch Caching	Disabled	
System BIOS Cacheable	Enabled	
Video RAM Cacheable	Enabled	
Memory Hole at 15M-16M	Disabled	
AGP Aperture Size	64MB	
AGP Auto Calibration	Enabled	

←→↑↓: Move Enter: Select +/-/PU/PD: Value F10: Save ESC: Exit F1: General Help
F5: Previous Values F6: Fail-Safe Defaults F7: Optimized Defaults

> DRAM Clock/Timing Control: Press <Enter> to reveal the following submenu.

System Performance

Use this item to select the System Performance mode.

The choices: Safe Mode; Normal Mode; Fast Mode; Turbo Mode; Ultra Mode

CAS Latency Setting

This item is to set CAS (Column Access Stroke) Latency time.

The Choices: 2T; 2.5T; 3T

DRAMAddr/CmdRate

This item is to set the DRAM Addr/Command rate.

The Choices: Auto; 1T; 2T

Prefetch Caching

This item is to enable/disable the Prefetch Caching function.
The Choices: Enabled , Disabled.

System BIOS Cacheable

This item is to enable/disable the System BIOS Cacheable function.

Video RAM Cacheable

Enabled: Enable Video RAM Cacheable.
Disabled :Disable Video RAM Cacheable.

Memory Hole At 15-16M

In order to improve performance, certain space in memory can be reserved for ISA cards. This memory must be mapped into the memory's space below 16MB.

The Choices: Disabled; Enabled.

AGP Aperture Size

Select the size of the Accelerated Graphic Port(AGP) aperture .
The aperture is a portion of the PCI memory address range dedicated for graphics memory address space. Host cycle that hit the aperture range are forwarded to the AGP without any translation.

The Choices: 128MB; 64MB; 32MB; 16MB; 8MB; 4MB; 256MB

AGP Auto Calibration

Use this item to enable/disable the AGP Auto Calibration.
The choices: Enabled; Disabled

2.6 Integrated Peripherals

Phoenix - AwardBIOS CMOS Setup Utility Integrated Peripherals

		Item Help
▶ SiS OnChip IDE Device	Press Enter	
Internal PCI/IDE	Both	
IDE Primary Master PIO	Auto	
IDE Primary Slave PIO	Auto	
IDE Secondary Master PIO	Auto	
IDE Secondary Slave PIO	Auto	
Primary Master Ultra DMA	Auto	
Primary Slave Ultra DMA	Auto	
Secondary Master Ultra DMA	Auto	
Secondary Slave Ultra DMA	Auto	
IDE Burst Mode	Enabled	
▶ SiS OnChip PCI Device	Press Enter	
SiS USB Controller	Enabled	
USB 2.0 Controller	Enabled	
USB Keyboard Support	Enabled	
SiS AC97 Audio	Auto	
SiS S/W Modem	Auto	
▶ Onboard Super IO Device	Press Enter	
Onboard FDC Controller	Enabled	
Onboard Serial Port 1	3F8/IRQ4	
Onboard Serial Port 2	2F8/IRQ3	
UART Mode Select	Normal	
x UR2 Duplex Mode	Half	
Onboard Parallel Port	378/IRQ7	
Parallel Port Mode	ECP	
ECP Mode Use DMA	3	
Game Port Address	201	
MIDI Port Address	330	
MIDI Port IRQ	10	
Onboard Lan Device	Enabled	
IDE HDD Block Mode	Enabled	
Init Display First	PCI Slot	
System Share Memory Size	32 MB	

←→↑↓: Move Enter:Select +/-/PU/PD:Value F10:Save ESC:Exit F1:General Help
F5:Previous Values F6:Fail-Safe Defaults F7:Optimized Defaults

Sis On-Chip IDE Device: Press Enter to configure the following submenu:

Internal PCI/IDE

Use this item to choose the ePCI/IDE mode.

The choices: Both; Disabled; Primary; Secondary

IDE Primary Master/Slave PIO

Auto: BIOS will automatically detect the IDE HDD Accessing mode.

Mode 0~4: Manually set the IDE Accessing mode.

IDE Secondary Master/Slave PIO

Auto: BIOS will automatically detect the IDE HDD Accessing mode.

Mode 0~4: Manually set the IDE Accessing mode.

Primary Master/Slave Ultra DMA

Auto: BIOS will automatically enable Ultra DMA mode of the IDE HDD Accessing .

Disabled: UDMA mode is disabled

Secondary Master/Slave Ultra DMA

Auto: BIOS will automatically enable the Ultra DMA mode of the IDE HDD Accessing mode.

Disabled: Ultra DMA disabled.

IDE Burst Mode

Use this item to enable/disable the IDE Burst mode.

SiS On-Chip PCI Device: Press Enter to configure the following submenu:

SiS USB Controller

Use this item to enable or disable the USB Controller.

The Choices: Enabled ; Disabled

USB 2.0 Controller

If USB Controller is enabled, use this item to enable or disable USB 2.0 controller.

The Choices: Enabled; Disabled

USB Keyboard Support

If USB Controller is enabled, use this item to enable or disable the USB Keyboard Support.

The Choices: Enabled ; Disabled

SiS AC97 Audio / S/W Modem

Use this item to enable/disable the AC97 Audio/ SW Modem function.

The Choices: Enabled; Disabled

Onboard Super IO Device: Press Enter to configure the following submenu:

Onboard FDC Controller

The choices: Enabled; Disabled

Onboard Serial Port 1/2

Select an address and corresponding interrupt for the first and second serial ports.

The Choices: Auto; 3F8/IRQ4; 2F8/IRQ3; 3E8/IRQ4; 2E8/IRQ3; Disabled.

UART Mode Select

This item allows you to select which Infra Red(IR) function of the onboard I/O chip you wish to use.

The Choices: Normal; IrDA; SCR; ASKIR

UR2 Duplex Mode

This item allows you to select which Infra Red(IR) function of the onboard I/O chip you wish to use.

The Choices: Half ; Full.

Onboard Parallel Port

This item allows you to select the onboard parallel port and IRQ.

The Choices: 378/IRQ7; 278/IRQ5; 3BC/IRQ7; Disabled

Parallel Port Mode

The choices are for Parallel Port Mode select:

The choices: SPP; EP;; ECP; ECP+EPP

ECP Mode Use DMA

The Choices: 3; 1.

Game Port Address

The choices are for setting Game Port Address:

201; 209; Disabled

MIDI Port Address

The choices are for setting MIDI Port Address:

300; 330 (default); Disabled.

MIDI Port IRQ

The choices are for setting MIDI Port IRQ:

10 ; 5

Onboard Lan Device

If your IDE HDD supports block mode select, enabled is for automatic detection of the optimal number of block read/write per sector the drive can support..

The Choices: Enabled; Disabled

IDE HDD Block Mode

If your IDE HDD supports block mode select, enabled is for automatic detection of the optimal number of block read/write per sector the drive can support..

The Choices: Enabled; Disabled

Init Display First

Use this item to select the initial display mode at system boot.

The Choices: PCI Slot;AGP

System Share Size

Use this item to set the memory size shared by system.

The Choices:4MB;8MB;16MB;32MB;64MB

2.7 Power Management Setup

Phoenix - AwardBIOS CMOS Setup Utility

Power Management Setup

		Item Help
ACPI Function	Enabled	
ACPI Suspend Type	S1(POS)	
Power Management	User Define	
Suspend Mode	Disabled	
Video Off Option	Suspend --> Off	
Video Off Method	V/H Sync+Blank	
Modem Use IRQ	Auto	
HDD Off After	Disabled	
Safe-Off by PWRBTN	Instant-off	
PWRON After PWR-Fail	Always off	
▶ PM Wake Up Events	Press Enter	
Power On by PS/2KB	Password	
X Power On by PS2MS	Disabled	
Power On By USB	Disabled	
Power On by PME/WOL	Disabled	
Power On By Modem Ring	Disabled	
RTC Alarm Resume	Disabled	
X Month Alarm	NA	
X Date (of Month) Alarm	0	
X Time(hh:mm:ss) Alarm	0 : 0 : 0	
Hot Key Function As	Disabled	
Delay Prior to Thermal	None	

←→↑↓: Move Enter:Select +/-/PU/PD:Value F10:Save ESC:Exit F1:General Help
 F5:Previous Values F6:Fail-Safe Defaults F7:Optimized Defaults

ACPI Function

The choices are for enabling or disabling the Advanced Configuration and Power Management (ACPI).

ACPI Function

Use this item to enable/disable the ACPI function.

The choices: enabled; disabled

ACPI Suspend Type

The choices are for setting the ACPI Suspend Type.

S1(Power On Suspend); S3(Suspend To RAM); S1&S3

Power Management

The choices are for setting the Power management mode:

User Define; Min Saving; Max Saving.

Suspend Mode

Use this item to set the Suspend time.

The choices: Disabled; 1~60 min.

Video Off Option

The choices are for setting the Video Off option:

Suspend --> Off; Susp, Stby --> Off; All Modes --> Off;

Always On

Video Off Method

The choices are for determining the manner in which the monitor is blanked.

The choices:

V/H SYNC+Blank: Turn off the vertical and horizontal synchronization ports and write blanks to the video buffer.

Blank Screen: Writes blanks to the video buffer.

DPMS Supported: Initial display power management signaling.

Modem Use IRQ

This determines the IRQ, which can be applied in Modem use.

The choices: Auto; 3; 4;5; 7; 9; 10; 11; NA

HDD Off After

Use this item to set the HDD Off After time.

The choices: Disabled; 1~15 min..

Safe-Off by PWRBTN

Use this item to set the Safe-Off by Power Button mode.
The Choices: Instant off; Delay 4 Sec.

PWRON After PWR-Fail

Use this item to set the PWRON After Power Fail mode
The Choices: Always off; Always on; Keep pre-state.

> PM Wake Up Events: Press <Enter> to configure the following:

Power On By PS/2KB

Use this item to set the Power On by PS/2 Keyboard function.
Option : Password; Any Key; Hot Key.

x Power On By PS/2 MS

Use this item to set the Power On by PS/2 Mouse.
Option : Disabled; Click; Move & Click.

Power On By USB

Use this item to enable/disable the Power On by USB function..

Power On By PME/WOL

Use this item to enable/disable the Power On by WOL function.

Power On By Modem Ring

Use this item to enable/disable the Power On by Modem Ring signal.

RTC Alarm Resume

Use this item to enable/disable the RTC Alarm Resume function.
Date: If RTC Alarm Resume is enabled, set the date with this item.

Time: If RTC Alarm Resume is enabled, set the time with this item.

Hot Key Function As

Use this item to set the Hot Key Function.
The choices: Disabled; Power Off; Suspend

Delay Prior to Thermal

Use this item to set the Delay time prior to thermal.
The choices: None; 1min; 2min; 4min; 8min; 16min; 32min; 64min

2.8 PnP/PCI Configurations

This section describes configuration of the PCI bus system. PCI or Personal Computer Interconnect, is a system which allows I/O devices to operate at speeds nearing the speed of the CPU itself when communicating with the components on board. This section covers some very technical items and it is strongly recommended that only experienced users should make any changes to the default settings.

Phoenix - AwardBIOS CMOS Setup Utility PnP/PCI Configurations

Reset Configuration Data	Disabled	Item Help
Resources Controlled By x IRQ Resources	Auto(ESCD) Press Enter	
PCI/VGA Palette Snoop	Disabled	

←→↑↓: Move Enter:Select +/-/PU/PD:Value F10:Save ESC:Exit F1:General Help
F5:Previous Values F6:Fail-Safe Defaults F7:Optimized Defaults

Reset Configuration Data

The system BIOS supports the PnP feature so the system needs to record which resource is assigned and proceeds to get rid of resource conflict. Every peripheral device has a node, which is called ESCD (Extended System Configuration Data). This node records which resources are assigned to it. If Disabled (Default) is chosen, the system ESCD will update only when the new configuration varies from the last one. If Enabled is chosen, the system is forced to update ESCDs and then is automatically reset to the “Disabled” mode.

Resources Controlled By

By Choosing “Auto”(default), the system BIOS will detect the system resources and automatically assign the relative IRQ and DMA channel for each peripheral. By choosing “Manual”, the user will need to assign IRQ & DMA for add-on cards. Be sure that no IRQ/DMA and I/O port conflict exists.

IRQ Resources :

Press Enter to configure the following Submenus

IRQ Resources

		Item Help
IRQ-3 assigned to	: PCI Device	
IRQ-4 assigned to	: PCI Device	
IRQ-5 assigned to	: PCI Device	
IRQ-7 assigned to	: PCI Device	
IRQ-9 assigned to	: PCI Device	
IRQ-10 assigned to	: PCI Device	
IRQ-11 assigned to	: PCI Device	
IRQ-12 assigned to	: PCI Device	
IRQ-14 assigned to	: PCI Device	
IRQ-15 assigned to	: PCI Device	

←→↑↓: Move Enter:Select +/-/PU/PD:Value F10:Save ESC:Exit F1:General Help
 F5:Previous Values F6:Fail-Safe Defaults F7:Optimized Defaults

IRQ Resources

When resources are controlled manually, assign each system interrupt a type, depending on the type of device using the interrupt.

PCI/VGA Palette Snoop

Choose Disabled or Enabled. Some graphic controllers which are not VGA compatible take the output from a VGA controller and map it to their display as a way to provide boot information and VGA compatibility.

However, the color information coming from the VGA controller is drawn from the palette table inside the VGA controller to generate the proper colors, and the graphic controller needs to know what is in the palette of the VGA controller. To do this, the non-VGA graphic controller watches for the write access to the VGA palette and registers the snoop data. In PCI based systems, the Write Access to the palette will not show up on the ISA bus if the PCI VGA controller responds to the Write.

In this case, the PCI VGA controller should not respond to the Write, it should only snoop the data and permit the access to be forwarded to the ISA bus. The non-VGA ISA graphic controller can then snoop the data on the ISA bus. Unless you have the above situation, you should disable this option.

The choices: Disabled (default); Enabled

2.9 PC Health Status

Phoenix - AwardBIOS CMOS Setup Utility

PC Health Status

	Item Help
Vcore	
Vcc 3.3V	
Vcc 5.0V	
Vcc 12.0V	
Vsb 5.0V	
Voltage Battery	
CPU Temperature	
System Temperature	
Fan 1 Speed	
Fan 2 Speed	
Fan 3 Speed	

←→↑↓: Move Enter:Select +/-/PU/PD:Value F10:Save ESC:Exit F1:General Help
F5:Previous Values F6:Fail-Safe Defaults F7:Optimized Defaults

This menu shows the current status of the system, CPU and CPU Fan. No value in this menu can be changed manually.

Vcore /+3.3V/+5V/12V/5Vsb

These items show the respective voltage running on board.

Voltage Battery

These items show the battery voltage used on board.

CPU /System Temp

This item shows the current System/CPU temperature.

FAN1/2/3 Speed

This item shows the fan speed running on board.

2.10 Frequency/Voltage Control

Phoenix - AwardBIOS CMOS Setup Utility Frequency/Voltage Control

		Item Help
Auto Detect PCI CLK	Enabled	
Spread Spectrum	Disabled	
CPU:DRAM Frequency Ratio	SPD	
CPU Clock	100	
x DRAM Frequency	133 MHz	

←→↑↓: Move Enter:Select +/-/PU/PD:Value F10:Save ESC:Exit F1:General Help
F5:Previous Values F6:Fail-Safe Defaults F7:Optimized Defaults

Auto Detect PCI CLK

This item allows you to enable/disable auto detect PCI CLOCK.
The Choices: Disabled; Enabled

Spread Spectrum

This function is designed for the EMI test only.
The Choices: Disabled; +/- 0.25%; +/-0.3%; +/- 0.35%; +/- 0.4%.

CPU Clock

Use this item to set CPU Clock .
The Choices: 100~132 for 100MHz CPU or 133~165 MHz in for 133MHz CPU in 1MHz stepping

CPU:DRAM Frequency Ratio

Use this item to set the CPU:DRAM Frequency Ratio.
The choices: 1:1; 1:2; 3:4; 3:5; 4:3; 4:5; SPD.

x DRAM Frequency

This item will show the DRAM Frequency with the CPU:DRAM frequency Ratio.

2.11 Load Fail-Safe Defaults

When you press <Enter> on this item, you get a confirmation dialog box with a message similar to below:

Phoenix - AwardBIOS CMOS Setup Utility

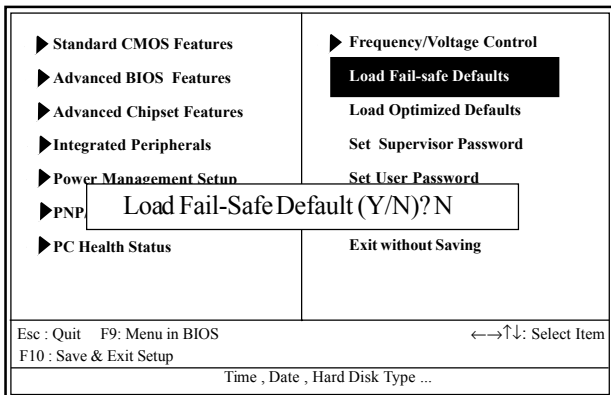

Pressing ‘Y’ loads the default values that are factory settings for optimal performance of system operations.

2.12 Load Optimized Defaults

When you press <Enter> on this item, you get a confirmation dialog box with a message similar to:

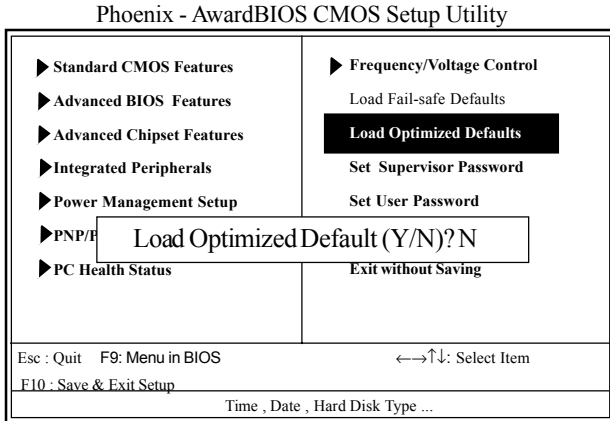

Pressing ‘Y’ loads the default values that are factory settings for optimal performance of system operations.

2.13 Set Supervisor / User Password

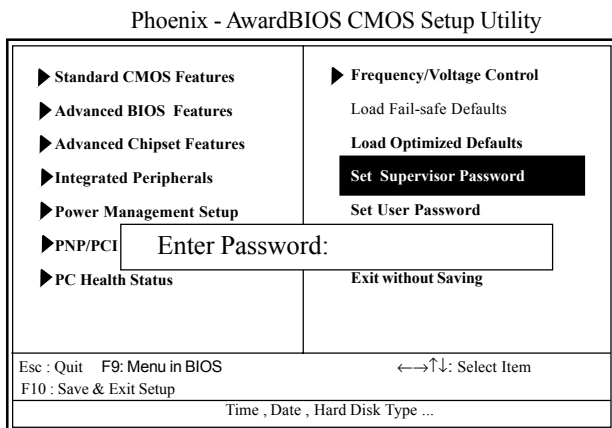

When you select this function, the following message will appear at the center of the screen to assist you in creating a password.

Enter Password (for Supervisor/User)

Type a password, up to eight characters, and press <Enter>. The password you type now will clear any previously entered password from CMOS memory. You will be asked to confirm the password. Type the password again and press <Enter>. You may also press <ESC> to abort the selection and not enter a password. To disable the password, just press <Enter> when you are prompted to enter a password. A message will confirm that you wish to disable the password. Once the password is disabled, the system will boot without asking user to enter a password.

Password for System or BIOS Setup

If you select “System” at the Security Option of BIOS Features Setup Menu, you will be prompted for the password every time when the system is rebooted, or any time when you try to enter Setup. If you select “Setup” at the Security Option of BIOS Features Setup Menu, you will be prompted only when you try to enter Setup.

2.14 Save & Exit Setup

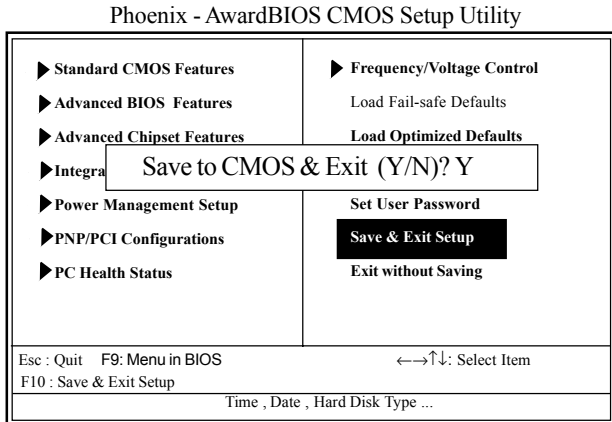

Typing “Y” will quit the Setup Utility and save the user setup value to RTC CMOS RAM.

Typing “N” will return to the Setup Utility.

2.15 Exit Without Saving

Phoenix - AwardBIOS CMOS Setup Utility

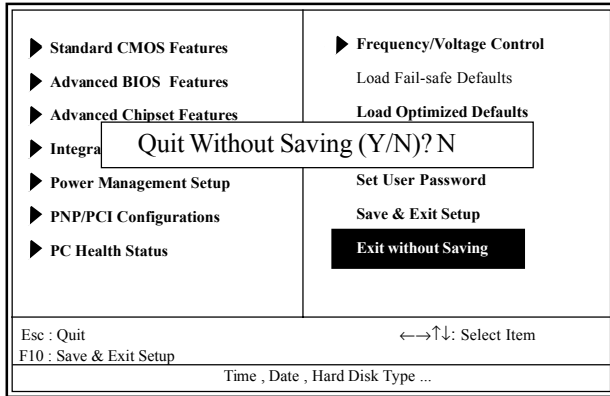

Typing “Y” will quit the Setup Utility without saving to RTC CMOS RAM.

Typing “N” will return to the Setup Utility.

Chapter 3

Drivers & Utilities

3. Drivers & Utilities

There are motherboard drivers and utilities included in the disc attached in this motherboard package. You don't have to install all of them for booting your system. But after you have finished the hardware installation, you have to install an operation system (such as windows XP) before you are able to install any drivers or utilities.

Note: Please be aware of the different Procedures for installing drivers for Windows 98/ME/XP/2000 .

3.1 Auto-run Menu

You can use the auto-run menu in the driver CD attached in the motherboard package. Then choose the utility or driver and select model name. The autorun starting screen looks like below:

(1) The SiS Auto-run CD Main Menu



(2) SiS DriverSetup Main Menu: Point to the "Driver" button with the mouse for SiS Drivers Setup.



(3) Click to the "Driver" button and the Drivers Setup List will appear as below:

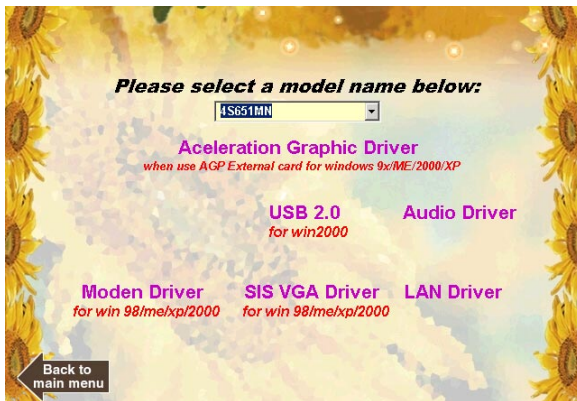

3.2 Installing SiS VGA Driver

Mouse-click on the "SiS VGADriver" item on the main menu to install the SiS VGAdrivers, and the InstallShield Wizard will start to run instantly. Please note that VGA Driver is for onboard VGA. If an external AGP card is used, user should install the "Acceleration Graphic Driver" instead of this "VGA Driver".

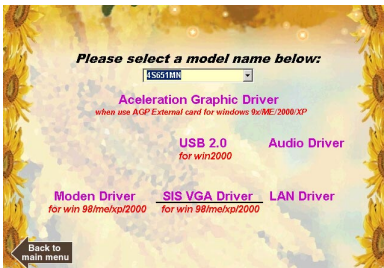

(1)
Click "SiS VGA Driver"
item to continue.



(2)
Click the OS running on
your system.

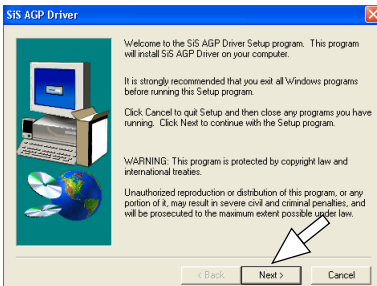

(3)
Click "Next" button to
continue.

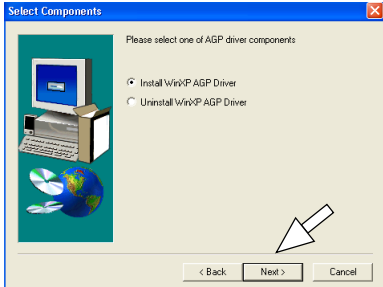

(4)
Click "Next" button to
continue.

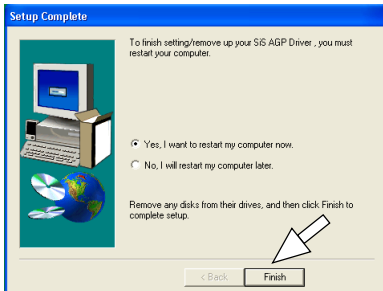

(5)
Click "Finish" button to
restart system so as to
put the just installed
driver into effect.

3.3 LAN Driver (for 4S651MN only)

Mouse click the "LAN Driver" item to install the built in LAN driver. The InstallShield Wizard will start to run instantly.



(1)
Click on the "LAN Driver"
item to start LAN driver
setup.

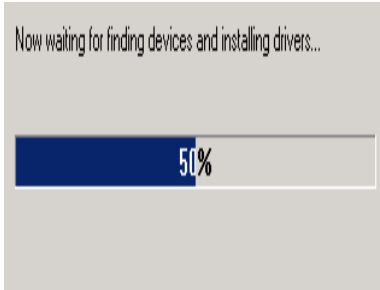

(2)
Click "Next" button to
continue.

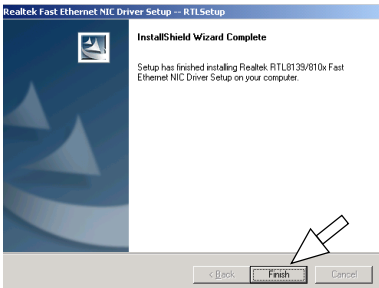

(3)
In a few seconds, Setup
completes. Click "Finish"
button to restart system and
complete setup.

3.4 Installing Audio Driver

Mouse click the "Audio Driver" item on the Main Menu to set up the Audio driver. The InstallShield Wizard will start to run instantly.

3.4.1 Installing 6-channel Driver

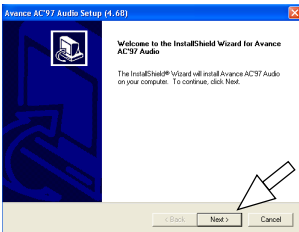

(1)
Click "Next" button to continue.

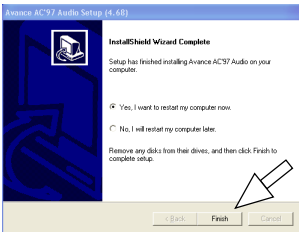

(2)
In a few seconds, setup completes. Click the "Finish" button to restart system and complete setup.

3.4.2 Verifying 6-channel Driver

(1) Click the Audio Manager "Sound Effect" on the Start Screen.



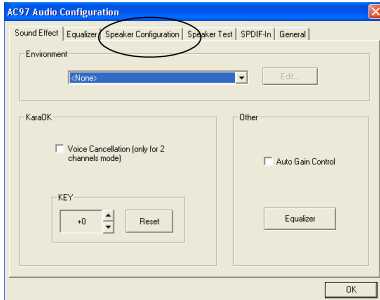

(2)
 Click "Speaker Configuration" button to configure the Audio connectors on mainboard.

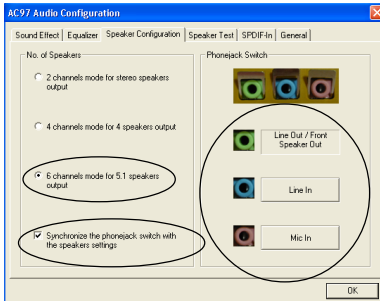

(3)
 Follow the instructions on the screen to configure the Audio connectors on board.

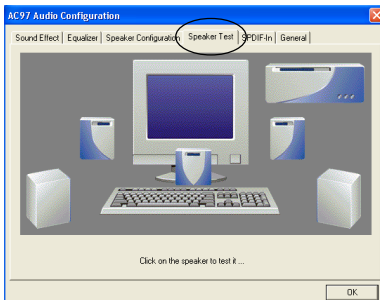

(4)
 Click "Speaker Test" button to test the 6-channel speakers.

3.5 Installing USB 2.0 Driver

Mouse click the "USB2.0" item to install the SiS USB 2.0 driver. The InstallShield Wizard will start to run instantly.



(1)
Click the "USB 2.0" item to install USB 2.0 driver. "

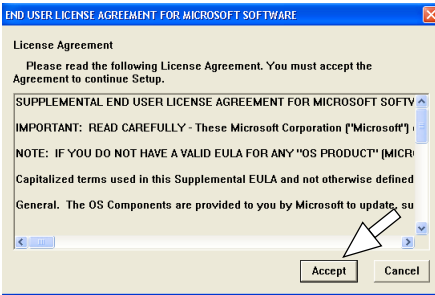

(2)
Click the "Accept" button to agree to the License Agreement and continue.

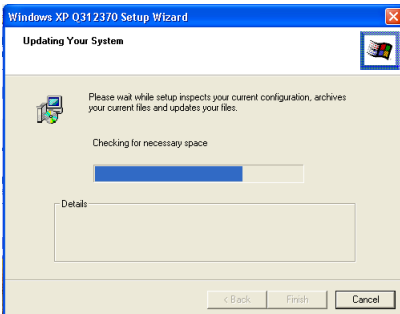

(2)
You can see the Setup Program is updating system.

(4) In a few seconds, Setup completes. Click "Yes" button to resatart system and complete setup.

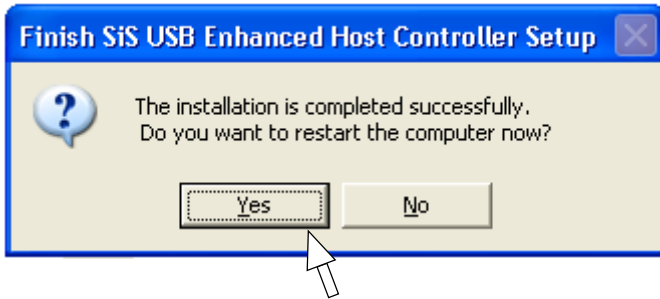

3.7 Installing Modem Driver (optional)

Mouse click the "Modem Driver" bar to install the SiS modem driver. The InstallShield Wizard will start to run instantly. Please note that LAN driver must be first installed before MODEM Driver can be installed.



(1)
Instantly, the "Setup files are exposed on screen. Click the "arrow Head" icon to continue.

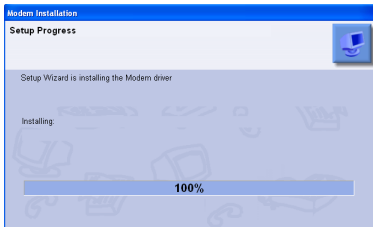

(2)
Next screen will show that installation goes on.

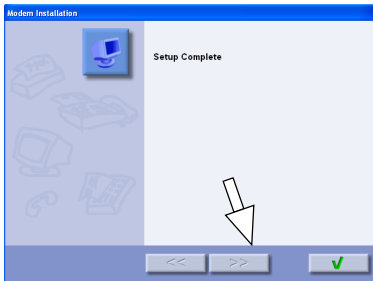

(3)
When the "Setup Complete" screen appears, click to the "Tick" icon button to finish setup.

Appendices

Motherboard Compatibility Test

(1) CPU Compatibility Test

System Configuration	Workstation - 1	Workstation - 2	Workstation - 3	Workstation - 4					
Memory	WINBOND-266								
	Transcend 256Mb2								
	W942608AH75 (S)								
Display Card	On-Board								
Hard Drive	Quantum 40G								
	AS40000AT100								
CD-ROM	ACER								
	652P-073 52X								
	CHANNEL WELL								
Power Supply	CWT-300ATX12 110V								
Nucleus	Model	CLK	Voltage	Bus Speed	CPU S.P.E.C	Stepping	RESET 10 Time	PW On/Off 10 Time	CC WS 2002 Test
Hyper Threading	3.06G	533	1.5		SL685		PASS	PASS	32.7
Hyper Threading	2.66G	533	1.5				PASS	PASS	32.3
Northwood	2.8G	533	1.525		SL6HL		PASS	PASS	34.2
Northwood	2.66G	533	1.5		SL6SK		PASS	PASS	31.2
Northwood	2.53G	533	1.525		QMUSES		PASS	PASS	31.9
Northwood	2.4BG	533	1.5		SL684		PASS	PASS	31.7
Northwood	2.26G	533	1.5		SL683		PASS	PASS	30.7
Northwood	2.6G	400	1.5		QWB5ES		PASS	PASS	31
Northwood	2.4G	400	1.5		SL67R		PASS	PASS	28.8
Northwood	2.0AG	400	1.5		SL5YR		PASS	PASS	29
Northwood	1.8AG	400	1.5		SL680		PASS	PASS	25.3
Northwood	1.6AG	400	1.5		SL668		PASS	PASS	23.8
Willamette	2.0G	400	1.75		SL5TL		PASS	PASS	23.5
Willamette	1.9G	400	1.75		SL5WR		PASS	PASS	23.1
Willamette	1.7G	400	1.75		SL5N9		PASS	PASS	21.7
Celeron	2.6G	400	1.5		QYD0ES		PASS	PASS	20.6
Celeron	2.4G	400	1.5		QWV8ES		PASS	PASS	20.7
Celeron	2.3G	400	1.5		SL6T2		PASS	PASS	19.6
Celeron	2.2G	400	1.5		QUW2		PASS	PASS	18.8
Celeron	2.1G	400	1.5		SL6SY		PASS	PASS	18.2
Celeron	2.0G	400	1.5		QPF7ES		PASS	PASS	18.7
Celeron	1.8G	400	1.75		SL6A2		PASS	PASS	18.1

Appendices

(2) AGP Display Card Compatibility Test

System Configuration	Workstation - 1	Workstation - 2	Workstation - 3	Workstation - 4
Processor	P4 Northwood	P4 Northwood	P4 Celeron	
	2.8G/133	2.26G/133	2.3G/100	
Memory	HYUNDAI-266	Infrneon-266	HYUNDAI-266	
	KINGSTON 256Mx2	Apacer 256Mx2	KINGSTON 256Mx2	
Hard Drive	HY5DU28822T-H (D)	HYB25D256800AT-7 (S)	HY5DU28822T-H (D)	
	WD 40G	Quantum 40G	SEGATE 30G	
CD-ROM	WD400BB-00DEA0/100	LD40000AT/100	ST330620A/100	
	ASUS	ASUS	GENNINE	
Power Supply	CD-S500/A 50X	CD-S500/A 50X	QC-852 52X	
	HIGH POWER	HIGH POWER	SEVENTEAN	
	HPC-340-101 220V	HPC-340-101 220V	ST-300BLV 220V	

Win98 SE 1024 x 768 x 32 bit

AGP Model	Vendor	AGP Mode	Dirver Version	3DMARK 2001SE Benchmark Mode	Quake III Demo 001		
					frames	seconds	fps
Radeon 9700	ATI	4X	4.13.01.9069	7589	1346	15.7	85.7
Ge Force 4 Ti4200	Winfast	4X	4.13.01.4345	6204	1346	10.7	125.7
Ge Force 4 Ti4200	Prolink	4X	4.13.01.4345	6013	1346	13	101.6
GF3 AGP 64M	Winfast	4X	4.13.01.3082	4714	1346	12.6	106.6
Ge Force 2 MX400	Triplex	4X	4.13.01.3082	2492	1346	23.8	56.7

Win98 SE 800 x 600 x 16 bit

AGP Model	Vendor	AGP Mode	Dirver Version	3DMARK 2001SE Benchmark Mode	Quake III Demo 001		
					frames	seconds	fps
GF3 GLADIAC 921 DVI	ELSA	4X	4.01.4109	5773	1346	13	103.8
Radeon 9500 LE	ATI	4X	4.13.01.9069	6444	1346	14.4	93.5
Xabre 200 / 64M	Acorp	4X	4.13.01.3080	3868	1346	21	64
GV-GF1280	Gigabyte	4X	4.13.01.3082	3482	1346	13.4	100.3
GA-GF 2560	Gigabyte	4X	4.13.01.3082	3812	1346	12.9	104.5

Win 2000 1024 x 768 x 32 bit

AGP Model	Vendor	AGP Mode	Dirver Version	3DMARK 2001SE Benchmark Mode	Quake III Demo 001		
					frames	seconds	fps
Ge Force 4 Ti4200	Winfasse	4X	4.3.4.5	10047	1346	6.9	195.4
Ge Force 4 Ti4600	WinFast	4X	4.3.4.5	9410	1346	7.1	190.2
XABRE PRO 64M TV-OUT	Triplex	4X	6.13.10.3080	6384	1346	8.6	156.8
Xabre 400 / 128M	Acorp	4X	6.13.10.3090	6100	1346	8.5	157.9
Radeon 64M	ATI	4X	5.13.1.6166	3406	1346	18.4	73.3

Appendices

Win 2000 800 x 600 x 16 bit							
AGP Model	Vendor	AGP Mode	Driver Version	3DMARK 2001 SE Bench. Mode	Quake III Demo 001		
					frames	seconds	fps
G550	Martox	4X	5.86.32.0	2160	1346	20.8	84.6
V7100PRO	ASUS	4X	4.3.4.5	8346	1346	7	191
Ge Force 4 Mx440	Prolink	4X	3.0.8.2	4028	1346	8.9	151
Radeon 9700	ATI	4X	6.13.10.6200	11995	1346	6.8	199.1
Radeon 9100	ATI	4X	6.14.10.6360	8898	1346	6.9	195.9
Win XP 1024 x 768 x 32 bit							
AGP Model	Vendor	AGP Mode	Driver Version	3DMARK 2001 SE Bench. Mode	Quake III Demo 001		
					frames	seconds	fps
Ge Force 4 Ti4200	Winfase	4X	4.3.4.5	9391	1346	7.2	187.1
Ge Force 4 Ti4200	Prolink	4X	4.3.4.5	9493	1346	7.1	188.3
Xabre 600 / 64M	Acorp	4X	6.13.10.3080	7098	1346	8.1	167.1
Xabre 400 / 64M	Acorp	4X	6.13.10.3080	5753	1346	10.9	123.3
Voodoo 4500	3dfx	2X	5.1.0.2600	1346	1346	33.7	40
Win XP 800 x 600 x 16 bit							
AGP Model	Vendor	AGP Mode	Driver Version	3DMARK 2001 SE Bench. Mode	Quake III Demo 001		
					frames	seconds	fps
Radeon 9700	ATI	4X	6.13.10.6200	12113	1346	6.8	198.4
Ge Force 2 GTS Ultra 64M	Creative	4X	3.0.8.2	6034	1346	6.9	184.3
Ge Force 4 Mx440	ACORP	4X	4.3.4.5	6483	1346	7.1	189.7
Ge Force 4 Mx440	Winfase	4x	4.3.4.5	6459	1346	7.1	190.2
Ge Force 3 Ti500	Winfase	4X	4.1.0.9	8954	1346	6.9	194.8

(3) Memory Compatibility Test

Module Vender	IC_Vender	IC_Serial Numbers	CAPACITY	SIDE	DRAM CLK	Location	Memtest 1.04	WS 2001 Business
China	Hynix	HY5DU56822AT-H	512M	D	266	DIMM 1	PASS	15.3
Retail	NANYA	NT5DS16M8AT-7K	512M	D	266	DIMM 1	PASS	16.6
Weblink	ELIPIX	N2DS12880AT-75B	256M	D	266	DIMM 1	PASS	17.6
Transcend	SAMSUNG	K4H560838C-TCB3	512M	D	333	DIMM 1	PASS	20.2
TwinMos	WINBOND	W942508AH-6	512M	D	333	DIMM 1	PASS	20.5
Kingmax	KINGMAX	KDL684T4A2A-05	256M	D	333	DIMM 1	PASS	19.3
Kingmax	KINGMAX	KDL684T4A2A-05	256M	D	333	DIMM 2	PASS	19.4
China	Hynix	HY5DU56822AT-H	512M	D	266	DIMM 2	PASS	20.4
Retail	NANYA	NT5DS16M8AT-7K	512M	D	266	DIMM 2	PASS	19.1
Weblink	ELIPIX	N2DS12880AT-75B	256M	D	266	DIMM 2	PASS	19.6
TwinMos	WINBOND	W942508AH-6	512M	D	333	DIMM 1,2	PASS	23.4
Kingmax	KINGMAX	KDL684T4A2A-05	256M	D	333	DIMM 1,2	PASS	20.5
China	Hynix	HY5DU56822AT-H	512M	D	266	DIMM 1,2	PASS	22.3
Retail	NANYA	NT5DS16M8AT-7K	512M	D	266	DIMM 1,2	PASS	18.6
Weblink	ELIPIX	N2DS12880AT-75B	256M	D	266	DIMM 1,2	PASS	20.3
Apacer	INFINEON	HYB25D256800AT-7	256M	D	266	DIMM 1,2	PASS	15.6
Apacer	INFINEON	HYB25D256800AT-7	256M	D	266	DIMM 2	PASS	16.2