

# TOSHIBA

VHS

## Video Cassette Recorder M-459

### OWNER'S MANUAL

**VCR** *Plus+*  
w/Cable Channel  
Changer



INSTALLATION 6

FIRST-TIME  
OPERATION 11

OPERATING  
CONTROLS 16

VIDEO CASSETTE 24

PLAYBACK 25

RECORDING 28

SPECIALIZED  
OPERATIONS 43



# Using This Manual

Congratulations on your choice of a TOSHIBA M-459. You have selected a high-quality, precision-engineered instrument designed to give you years of video and audio enjoyment.

To get the best performance from your new VCR, it is important that you carefully read and follow the operating instructions in this manual in the sequence in which they are presented.

Should you experience a problem, please follow the "Trouble Checks" on page 48. The warranty describes what will be done for you should your new VCR need service during the warranty period. It also tells you how and from whom you should request service.

## Table of Contents

|                         |   |
|-------------------------|---|
| Safety Precautions..... | 1 |
| Accessories.....        | 1 |

|                                   |     |
|-----------------------------------|-----|
| <b>IMPORTANT SAFEGUARDS</b> ..... | 3-5 |
|-----------------------------------|-----|

|   |   |
|---|---|
| <b>GENERAL INSTALLATION INFORMATION</b> |   |
| Choosing a Location for Your VCR.....   | 6 |

|                                     |      |
|-------------------------------------|------|
| <b>INSTALLATION</b>                 |      |
| TV Antenna and VCR Connections..... | 7    |
| VCR and TV Connections.....         | 8    |
| CATV Connections.....               | 9-10 |

|   |       |
|---|-------|
| <b>FIRST-TIME OPERATION</b>   |       |
| Unpack the VCR and Accessories.....   | 11    |
| Install the Batteries in the Remote Control.....                                  | 11    |
| Connect an Antenna or Cable-TV System to the VCR.....                             | 11    |
| Set the CH3/CH4 Switch on the Back of the VCR to<br>Select the "VCR Channel"..... | 11    |
| Turn on the VCR and Select an Active Channel.....                                 | 12    |
| Set the CATV.....   | 12    |
| Learn How to Use the TV/VCR Button.....   | 12    |
| Test the VCR Connections.....   | 12    |
| AutoProgram Channels Into the Channel Memory.....                                 | 13-14 |
| Set the Clock and Date.....   | 14    |
| Make a Recording and Play It Back.....  | 15    |

|  |       |
|--|-------|
| <b>VCR'S OPERATING CONTROLS</b>                  |       |
| VCR's Jack Panels.....                           | 16    |
| VCR's Operating controls.....                    | 17    |
| VCR's Display Panel.....                         | 18    |
| Remote Control Buttons that Control the VCR..... | 19-20 |
| Remote Control Buttons that Control a TV.....    | 21-22 |

|   |    |
|---|----|
| <b>VCR FEATURES</b>                     |    |
| Quick-Play Feature.....                 | 23 |
| High-Speed Rewind and Fast Forward..... | 23 |
| Auto Head Cleaner.....                  | 23 |
| Three Language Menus.....               | 23 |
| VCR Function Set Up Menu.....           | 23 |

|                                       |    |
|---------------------------------------|----|
| <b>VIDEO CASSETTES</b>                |    |
| Tape Speed.....                       | 24 |
| Erase protection.....                 | 24 |
| Inserting and Removing Cassettes..... | 24 |
| Cassette Care and Storage.....        | 24 |

|  |    |
|--|----|
| <b>PLAYBACK</b>                            |    |
| Playback Guide.....                        | 25 |
| Picture Search.....                        | 26 |
| Accel Search.....                          | 26 |
| Double Speed Playback.....                 | 26 |
| Variable Speed Slow-Motion Playback.....   | 26 |
| Still for Stop-Action Playback.....        | 26 |
| Frame Advance.....                         | 26 |
| Tracking(Automatic and Manual).....        | 26 |
| On-Screen Displays.....                    | 27 |
| Time Counter with Memory-Stop Feature..... | 27 |

|   |       |
|---|-------|
| <b>RECORDING</b>                              |       |
| Recording Guides.....                         | 28    |
| Tape Recording Speeds.....                    | 28    |
| Recording with TV Turned Off.....             | 28    |
| Recording and Viewing the Same Program.....   | 29    |
| Recording and Viewing Different Programs..... | 29    |
| One Touch Recording (OTR).....                | 30    |
| Cable Box Control Set Up.....                 | 31-32 |
| Programming the Timer.....                    | 33-34 |
| VCR Plus+.....                                | 35-39 |
| Timer Recording.....                          | 40    |
| Recording From a Camcorder.....               | 41    |
| Recording From another VCR.....               | 42    |

|   |    |
|---|----|
| <b>SPECIALIZED OPERATIONS</b>               |    |
| Index.....                                  | 43 |
| Index Register.....                         | 43 |
| Scan and Play (Index Playback).....         | 43 |
| Skip Search 1 (Index Playback).....         | 44 |
| Skip Search 2 (Using the FRAME button)..... | 45 |
| Repeat Play.....                            | 45 |
| Remaining Tape Display Function.....        | 46 |
| Copying VCR Recording.....                  | 47 |

|                             |    |
|-----------------------------|----|
| <b>TROUBLE CHECKS</b> ..... | 48 |
|-----------------------------|----|

|                               |    |
|-------------------------------|----|
| <b>CLEANING THE VCR</b> ..... | 49 |
|-------------------------------|----|

|                                    |    |
|------------------------------------|----|
| <b>DESIGN SPECIFICATIONS</b> ..... | 49 |
|------------------------------------|----|

|                                   |            |
|-----------------------------------|------------|
| <b>VCR LIMITED WARRANTY</b> ..... | Back Cover |
|-----------------------------------|------------|

# IMPORTANT SAFEGUARDS

**CAUTION: PLEASE READ AND OBSERVE ALL WARNINGS AND INSTRUCTIONS GIVEN IN THIS OWNER'S MANUAL AND THOSE MARKED ON THE UNIT. RETAIN THIS BOOKLET FOR FUTURE REFERENCE.**

This set has been designed and manufactured to assure personal safety. However, improper use can result in electric shock or fire hazard. The safeguards incorporated in this unit will protect you if you observe the following procedures for installation, use and servicing. This unit is fully transistorized and does not contain any parts that can be repaired by the user.

**DO NOT REMOVE THE CABINET COVER, OR YOU MAY BE EXPOSED TO DANGEROUS VOLTAGES. REFER SERVICING TO QUALIFIED SERVICE PERSONNEL.**

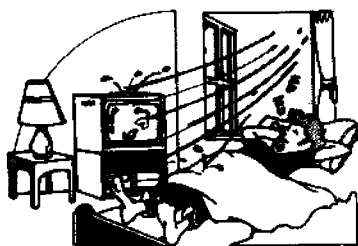
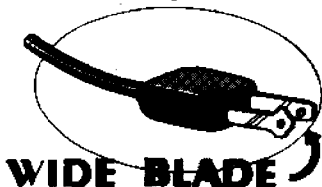
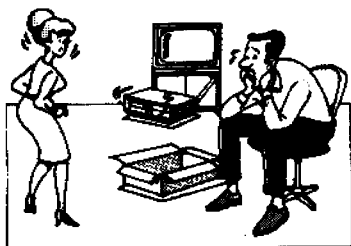

1. After unpacking this video product, read the owner's manual carefully, and follow all the operating and other instruction
2. This video product should be operated only from the type of power source indicated on the marking labels. If you are not sure of the type of power supply to your home, consult your sales person or your local power company. For video products intended to operate from battery power, or other sources, refer to the operating instructions.
3. This video product is equipped with a polarized alternating current line plug (a plug having one blade wider than the other). This plug will fit into the power outlet only one way. This is a safety feature. If you are unable to insert the plug fully into the outlet, try reversing the plug. If the plug should still fail to fit, contact your electrician to replace your obsolete outlet. Do not defeat the safety purpose of the polarized plug.
4. Slots and openings in the cabinet are provided for ventilation and to ensure reliable operation of the video product and to protect it from overheating, and these openings must not be blocked or covered. The openings should never be locked by placing the video product on a bed, sofa, rug or other similar surface. This video product should never be placed near or over a radiator or heat register. This video product should not be placed in a built-in installation such as a bookcase or rack unless proper ventilation is provided or the manufacturer's instructions have been adhered to.
5. Do not expose this video product to rain or use near water. For example, near a bath tub, wash bowl, kitchen sink, or laundry tub, in a wet basement, or near a swimming pool and the like.
6. Unplug the video product from wall outlet before cleaning. Use only a soft damp cloth a never use bezine, thinner or other solvents for cleaning.

# IMPORTANT SAFEGUARDS(continued)

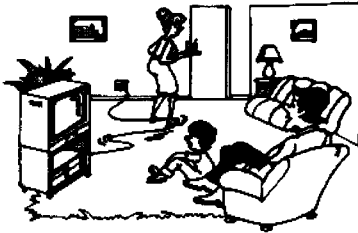

7. Do not allow anything to rest on the power cord. Do not locate this video product where the cord will be walked on.

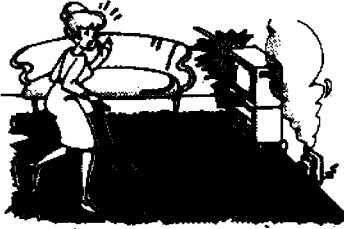

8. Do not overload wall outlets and extension cords as this can result in fire or electric shock.

9. If an outside antenna or cable system is connected to the video product, be sure the antenna or cable system is grounded so as to provide some protection against voltage surges and built-up static charges. Section 810 of the National Electrical Code, ANS/NFPA 70, provides information with respect to proper grounding of the mast and supporting structure, ground of the lead-in wire to an antenna discharge unit, size of grounding of the mast and supporting structure, grounding of the lead-in wire to an antenna discharge unit, size of grounding conductors, location of antenna-discharge unit, connection to grounding electrodes, and requirements for the grounding electrode.

- Use No. 10 AWG (5.3 mm<sup>2</sup>) copper, No. 8 AWG (8.4 mm<sup>2</sup>) aluminum, No. 17 AWG (1.0 mm<sup>2</sup>) copper-clad steel or bronze wire, or larger, as a ground wire.
- Secure antenna lead-in and ground wires to house with stand-off insulators spaced from 4.6 feet (1.22-1.83m) apart.
- Mount antenna discharge unit as close as possible to where lead-in enters house.
- Use jumper wire not smaller than No. 6 AWG (13.3mm<sup>2</sup>) copper, or the equivalent, when a separate antenna-grounding electrode is used. See NEC section 810-21 (j).

## EXAMPLE OF ANTENNA GROUNDING AS PER NATIONAL ELECTRICAL CODE

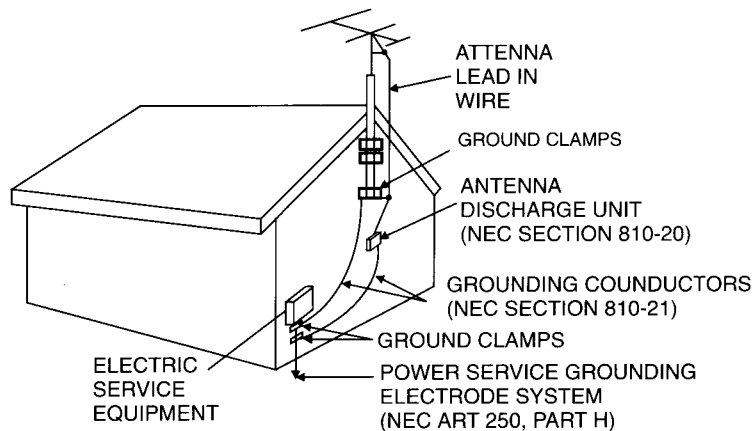

S2898A

10. An outside antenna system should not be located in the vicinity of overhead power lines or other electric light or power circuit, or where it can fall into such power lines or circuits. When installing an outside antenna system, extreme care should be taken to keep from touching such power lines or circuits as contact with them might be fatal.



11. For added protection for this video product receiver during a lightning storm, or when it is left unattended and unused for long periods of time, unplug it from the wall outlet and disconnect the antenna or cable system. This will prevent damage to the video product due to lightning and power-line surges.

# IMPORTANT SAFEGUARDS(continued)



12. An appliance and cart combination should be moved with care. Quick stops, excessive force, and uneven surfaces may cause the appliance and cart combination to overturn.

13. Never push objects of any kind into this video product through openings as they may touch dangerous voltage points or short-out parts that could result in a fire or electric shock. Never spill liquid of any kind on the video product.

14. Do not use attachments not recommended by the video product manufacturer as they may cause hazards.

15. Do not place this video product on an unstable cart, stand, tripod, bracket, or table. The video product may fall, causing serious injury to a child or adult, a serious damage to the appliance. Use only with a cart, stand, tripod, bracket, or table recommended by the manufacturer, or sold with the video product.



16. Unplug this video product from the wall outlet and refer servicing to qualified service personnel under the following conditions :

A. When the power-supply cord or plug is damaged.

B. If liquid has been spilled, or objects have fallen into the video product.

C. If the video product has been exposed to rain or water.

D. If the video product does not operate normally by following the operating instructions. Adjust only those controls that are covered by the operating instructions as an improper adjustment of other controls may result in damage and will often require extensive work by a qualified technician to restore the video product to its normal operation.

E. If the video product has been dropped or the cabinet has been damaged.

F. When the video product exhibits a distinct change in performance.

Do not attempt to service this video product yourself as opening or removing covers may expose you to dangerous voltage or other hazards. Refer all servicing to qualified service personnel.

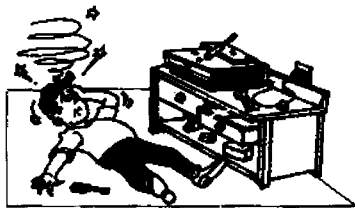
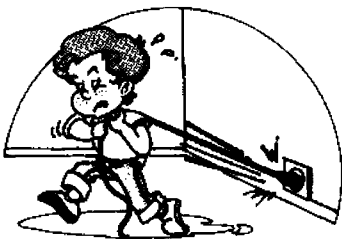

17. Upon completion of any service or repairs, request the service technicians assurance that only Factory Authorized Replacement Parts that have the same characteristics as the original parts were used, and that routine safety checks have been performed to determine that the video product is in safe operating condition. Unauthorized parts may result in fire, electrical shock, or other hazards.



# GENERAL INSTALLATION INFORMATION

## Choosing a Location for your VCR

- Choose a location that is convenient, but away from sources of heat such as direct sunlight and heating units.
- If the VCR is to be installed in an equipment rack or cabinet with other components, be sure that there is adequate ventilation at the back and around the sides of the components. The VCR should not be placed on or directly above a stereo amplifier because of the heat that rises from the amplifier.
- Choose a flat surface at least as large as the VCR so that it rests on its mounting feet. It is important that air can pass through the ventilation holes in the bottom of the unit to prevent it from overheating. Do not operate the VCR on a rug or carpet because the pile will obstruct these holes.

Some TV sets may cause interference in home VCR's. To avoid interference and get the best performance from your VCR, follow these guidelines :

- When placing the VCR under a TV, keep at least 18 inches between the bottom of the TV and the top of the VCR.
- If interference is present when the VCR is used on top of the TV or at the 18-inch distance below the set, move the VCR to a position beside the TV.
- If moving the VCR does not solve the interference problem, try plugging the VCR into a different wall socket.
- If interference continues after all the above, call your dealer or service representative.

## What Are VHF and UHF?

When television broadcasting began, we called twelve VHF (very high frequency) channels and numbered them 2 through 13.

Later, as television broadcasting expanded, we called UHF (ultra high frequency) channels.

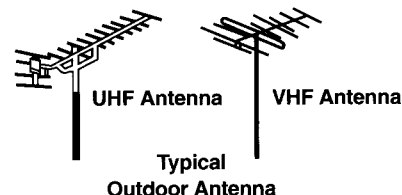
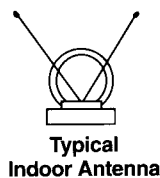

Your home antenna is a "signal receiver" that picks up TV broadcasts out of the air. These are several different types of antennas :

- Some receive only VHF channels.
- Some receive only UHF channels.
- Some receive both VHF and UHF channels.

Depending on the type of antenna, signals from the antenna can be conducted through either flat "twin-lead" cable or through round "coaxial" cable as shown below.

## Types of Antenna Cables

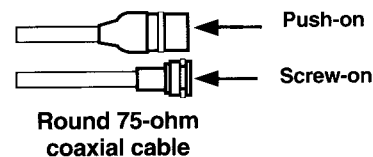
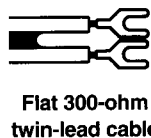

Cable-TV (CATV) supplies television signals directly by round cable without the need for a home antenna. Cable-TV can deliver both VHF and/or UHF channels and programs not available from a home antenna. You will usually get better picture quality (for recording TV programs) if you connect an outdoor antenna or cable-TV system to your VCR. If this is not possible (or if you are in an area with good signal reception), use a good quality indoor antenna.

# INSTALLATION

## TV Antenna and VCR Connections

To connect the VCR to an antenna(Fig. 1), to combination VHF/UHF antenna(Fig.2), take the following steps:

Remove the VHF and/or UHF cable from your TV terminals and reconnect them to the VCR terminal as shown in the diagrams below.

**Note:** For VHF and UHF connections, follow procedure ① if you have a 75  $\Omega$  (ohm) coaxial cable, and follow procedure ② if you have a 300  $\Omega$  (ohm) twin lead connector.

**Figure 1. VHF or UHF Reception Areas**

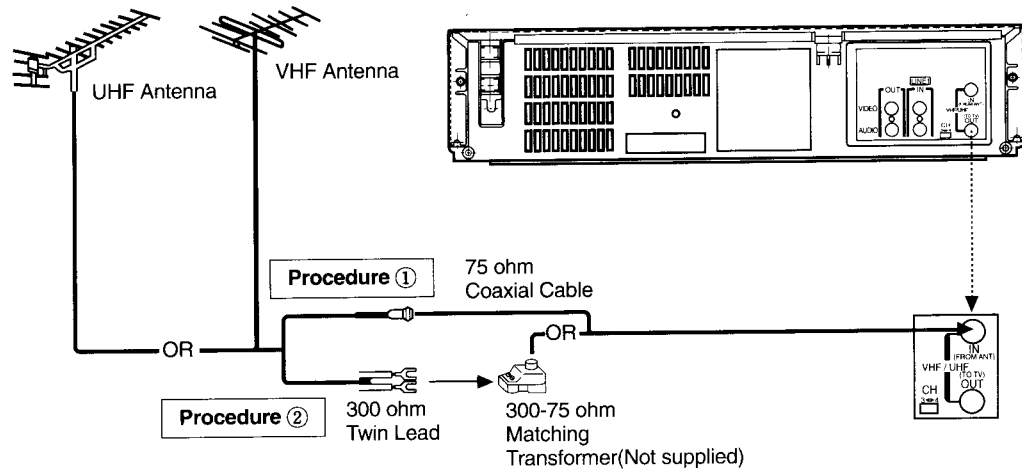

**Figure 2. Combined VHF/UHF Reception Areas**

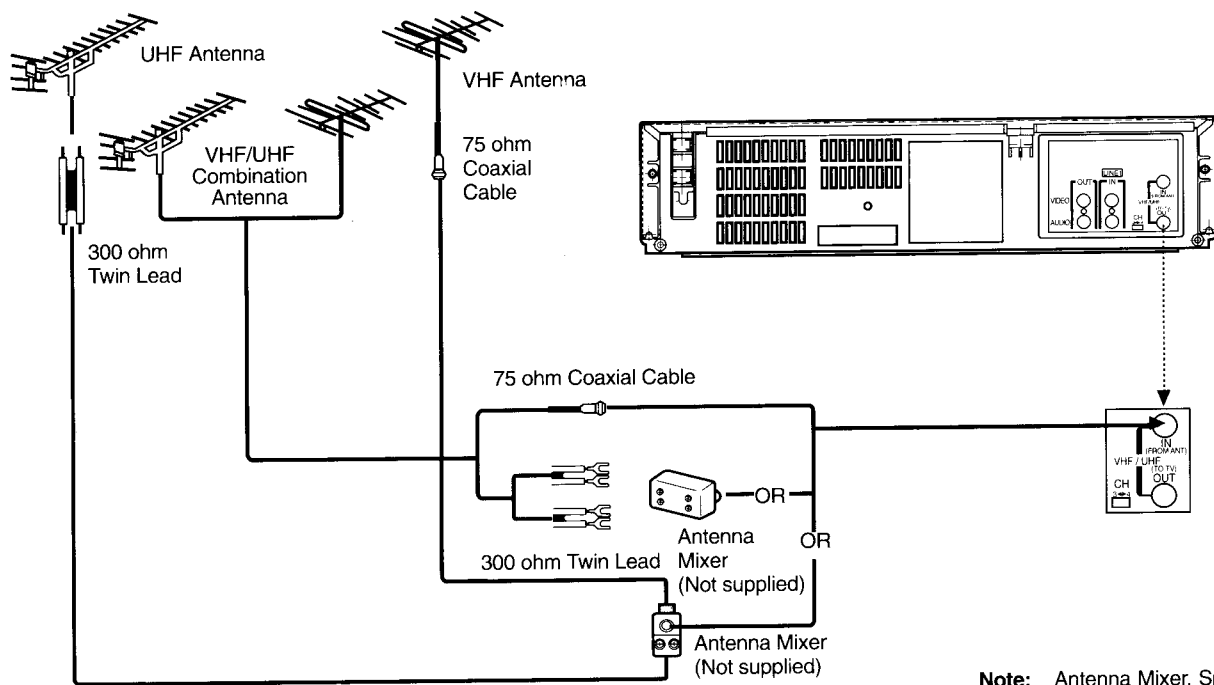

**Note:** Antenna Mixer, Splitter and Matching Transformer(75  $\Omega$   $\rightarrow$  300  $\Omega$  , 300  $\Omega$   $\rightarrow$  75  $\Omega$  )is available from your local electronics store.



# INSTALLATION(continued)

## VCR and TV Connections

### Connection to TV Antenna terminals

Fig. 1 VHF(75ohm/300ohm) or VHF(75ohm) terminals connection

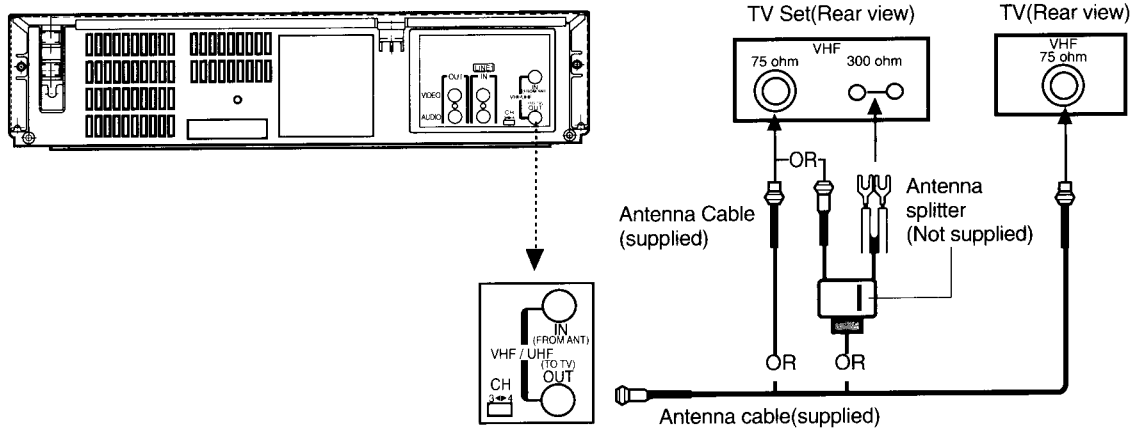
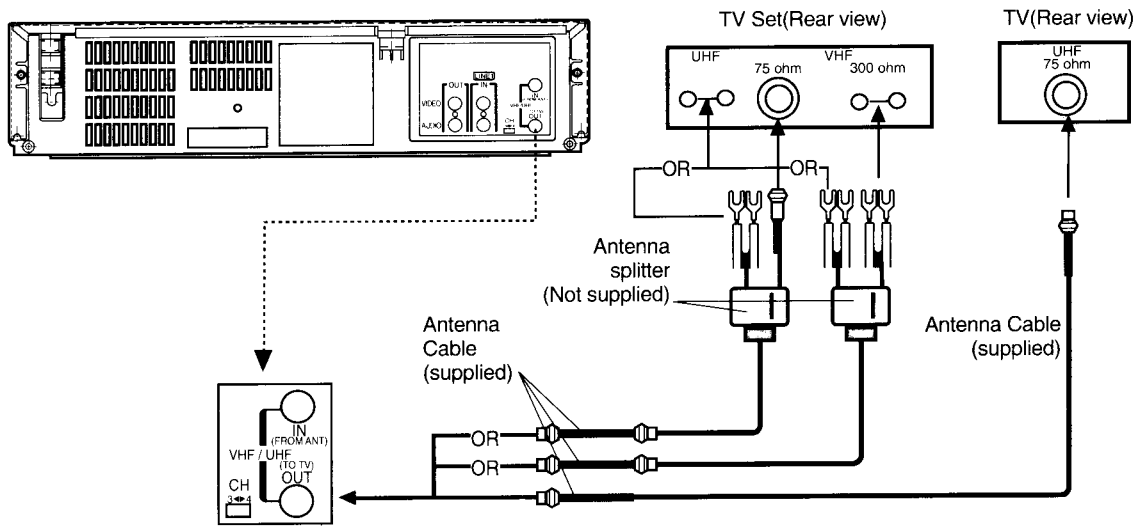
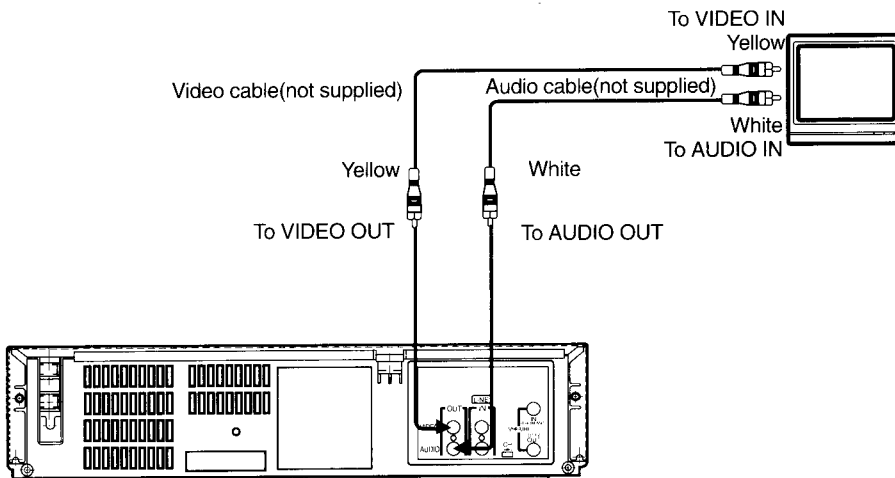

Fig. 2 VHF/UHF(75ohm/300ohm) or VHF/UHF(75ohm) terminals connection



### Connection to the TV with "VIDEO IN" and "AUDIO IN" connections



# INSTALLATION(continued)

## CATV Connections

There are several different systems of cable television at present. Therefore, there may be times when you use this VCR with one of these cable TV services.

We recommend that you consult your cable TV company to make sure that the cable is connected properly to match the cable TV system you want to watch.

**Fig. 1 To record and watch unscrambled channels**

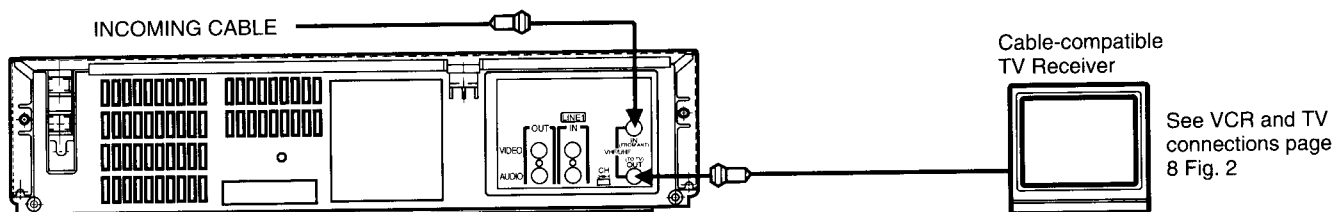

This set-up will enable you to do the following :

- Record unscrambled channels (limited by the capabilities of VCR tuner, for example 122 channel tuning or 181 channel tuning.)
- Record one channel and watch another.
- Use the programmable timer.

**Fig. 2 To record and watch the same channel(unscrambled/scrambled)**

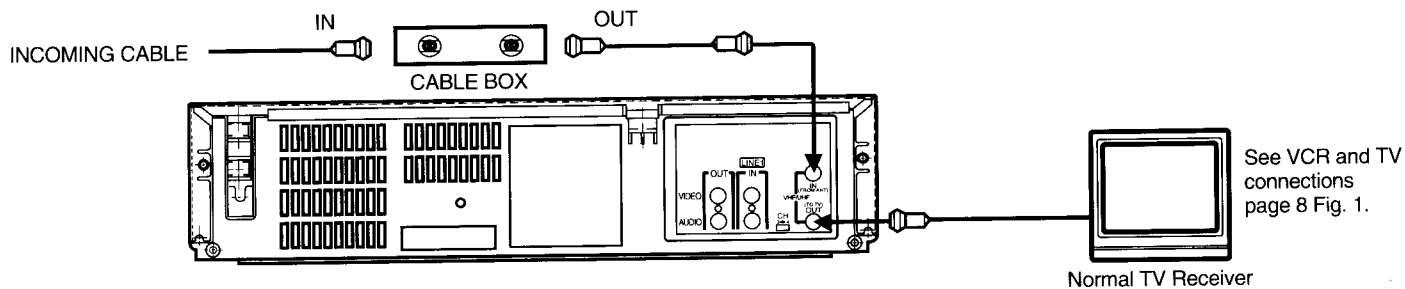

This set-up will enable you to do the following :

- Record all available cable channels through the cable box.
- When using the programmable timer recording, the cable box must be ON.

- Note:**
- Set VCR to the output channel of the cable box.
  - This set-up will not allow you to record one channel and watch another.

### ※ Position Cable Box

Position a remote-controllable cable box on top of the VCR as shown. Make sure that the front of the CABLE BOX (remote sensor) projects out in front of the VCR (transmitter).

### Top View

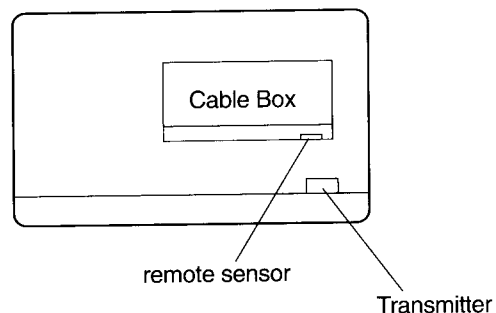

# INSTALLATION(continued)

**Fig. 3** To record and watch the same channel(uncrambled or scrambled)—when the A/B switch is in the B.

**Fig. 4** To record one unscrambled or scrambled channel and watch another unscrambled channel—when the A/B switch is in the A.

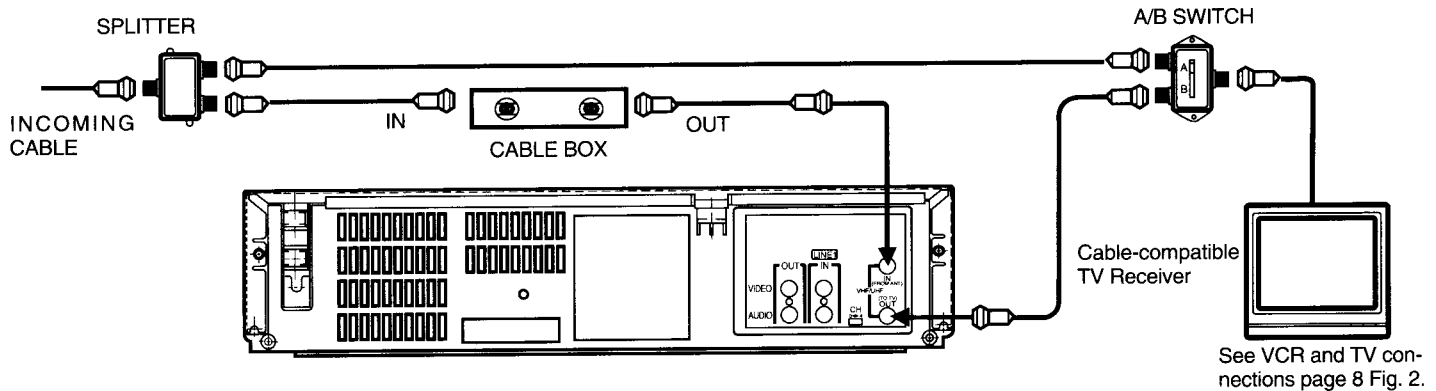

## ※ Position Cable Box

Position a remote-controllable cable box on top of the VCR as shown. Make sure that the front of the CABLE BOX (remote sensor) projects out in front of the VCR (transmitter).

This set-up will enable you to do the following.

- Record all cable channels from the cable box.
- Record one scrambled or unscrambled channel and watch another unscrambled channel.
- Use the TV remote control when the A/B switch is in the "A" position.
- When using the programmable timer recording, the cable box must be ON.

## "Unscrambled" Cable Channels

Cable companies usually include "Unscrambled" channels in their basic subscription price. Depending on the tuning capability of your TV (how many cable channels your TV is capable of tuning to) you may not need a cable box (supplied by the cable company) to view "unscrambled" cable channels on your TV set.

## "Scrambled" Channels

Extra (optional) pay cable channels, like HBO and Cinemax in some localities, are often "scrambled" by the cable company. To view these channels on your TV, you must use the cable (decoder) box supplied by the cable company.

## Cable Box(supplied by Cable Company)

Until recently, all television and VCR receivers were equipped with 69 channel tuners capable of tuning the 12 standard VHF channels (2-13) and the 56 UHF channels (14-69). Since cable television systems do not use the UHF band, once they began expanding beyond 12

## Top View

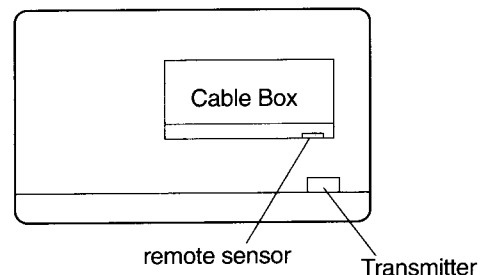

- Notes:**
- Set the VCR channel selector to output Channel of the cable box.
  - Select the channel to be recorded on the cable box.
  - Set the TV channel selector to output channel of VCR (3 or 4).

channel capacity (some cable companies transmit up to 100 channels) some form of cable box became necessary to enable their subscribers to tune in the additional channels. This "cable box" rebroadcasts the programs to your TV set or VCR on one designated channel, usually channel 2,3, or 4. When you use a cable box, you will normally change channels using the channel selector on the box. Some cable box have built-in decoders that translate "scrambled" pay TV channels (i.e. HBO) so they can be used by your TV set.

**Cable compatible**—either TV or VCR, when cable is connected, can tune to unscrambled cable channels, without the use of a cable box. There is a limitation to the tuning mechanism of the TV or VCR. This is usually as 105 channel tuning, 117 channel tuning, 133 channel tuning.

**Frequency Conversion**—simply means the ability to change one frequency to another (eq. when channel 7 is selected—the cable box takes the channel 7 information and outputs the channel 7 information on channel 3 frequency; for example when channel 11 is selected—the cable box takes the channel 11 information and outputs the channel 11 information on channel 3 frequency). The cable box and the VCR use this principle of frequency conversion.

# FIRST-TIME OPERATION

Even if you have never used a VCR before, you can get your VCR connected and working quickly by following the simplified steps below. The page numbers on which you can find detailed instructions for each of these steps are also listed for your convenience.

## 1. Unpack the VCR and Accessories

Make sure you remove all the accessories and information sheets that came packed with your VCR.

- save the packing materials and box in case you ever need to ship or store your VCR.
- The items shown below came packed with your VCR. If any are missing or appear damaged, contact your TOSHIBA VCR dealer immediately.

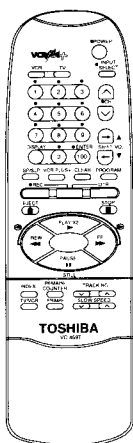

Remote Control

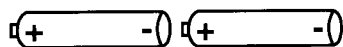

Remote Control Batteries  
(Size "AAA" 1.5 Volts)

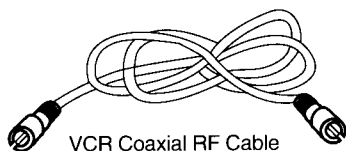

VCR Coaxial RF Cable

**Caution:** Avoid operating your VCR right after you have moved it from a cold location directly to a warm location. Moisture may have condensed on the head drum inside the VCR that may cause the tape to stick and damage the head wheel or tape. Let the VCR warm up for about 1-1/2 to 2 hours before inserting a video cassette.

## 2. Install the Batteries in the Remote Control

Turn the remote control over, and remove the cover of the battery compartment. Insert the batteries in the battery compartment so that their positive (+) ends contact the positive terminals. Replace the cover.

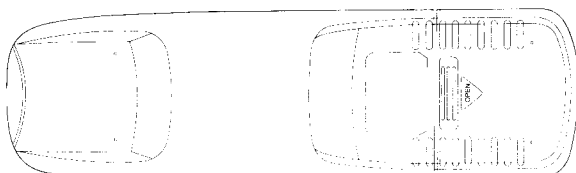

Battery  
Compartment  
cover

**Notes:** Never place anything heavy on top of the remote control or lay it upside-down. This may accidentally depress the buttons for a long time and discharge the batteries.

Replace the batteries when the VCR fails to respond to the remote control.

Remove the batteries from the remote control if it will not be used for a month or more. This will help prevent possible damage from battery leakage.

## 3. Connect an Antenna or Cable-TV System to VCR

Your VCR is quite easy to install. To connect an antenna or cable-TV system, you will first be attaching the antenna to the VCR, and then connecting the VCR to the TV as shown below. *Detailed instructions for connecting more complicated types of systems are on page 7-10.*

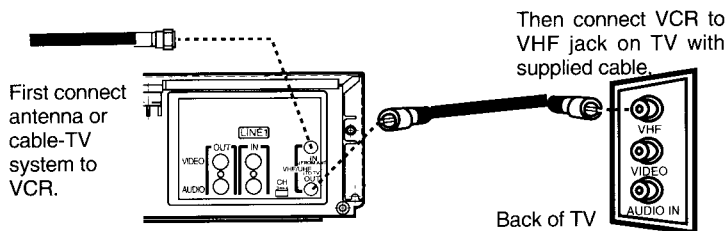

First connect antenna or cable-TV system to VCR.

Then connect VCR to VHF jack on TV with supplied cable.

**Remember:** When you connect the *OUT TO TV* jack on the VCR to the TV as shown above, you will be tuning your TV to channel 3 or 4 to see the signals from the VCR.

**Optional for TV Monitors:** If your TV is monitor that has *AUDIO* and *VIDEO IN* jacks, you can use optional audio/video cables to connect your VCR to the TV as shown below. This connection may produce a slightly better picture during playback.

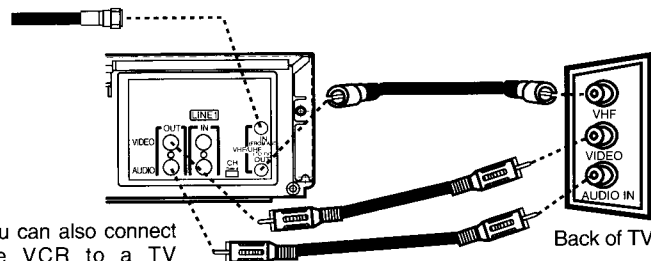

You can also connect the VCR to a TV monitor with Optional audio/video cables.

**Remember:** When you connect the *AUDIO* and *VIDEO OUT* jacks on the VCR to a TV monitor as shown above, you will be tuning your monitor to its video input channel (varies with TV models) to see the signal coming from the VCR. You will also be able to see the VCR's signal on channel 3 or 4.

## 4. Set the CH3/CH4 Switch on the Back of the VCR to Select the "VCR Channel"

First set the *CH3/CH4* switch on the back of the VCR to either channel 3 or 4, and then tune your TV to the same channel. This is called to "VCR Channel"

Remember that your TV must always be turned on and turned to this channel (3 or 4) for you to see what the VCR is doing (unless you have a TV monitor). If you have connected your VCR to a TV monitor with audio/video cables as shown above, set your TV to its proper video input channel (such as 91, etc.) to see what the VCR is doing.

# FIRST-TIME OPERATION(continued)

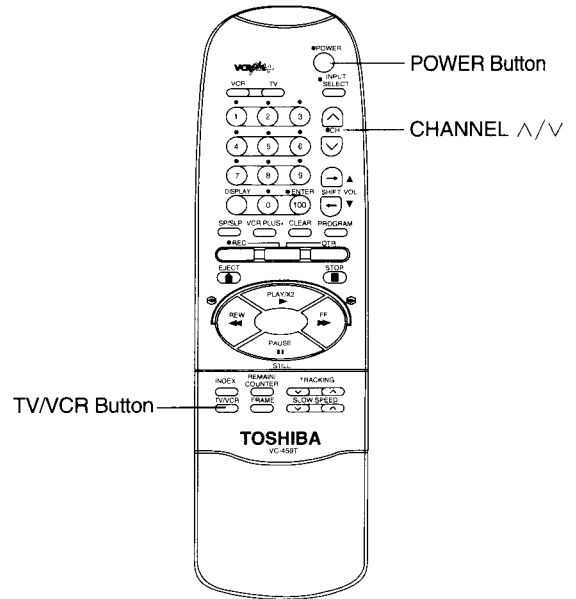
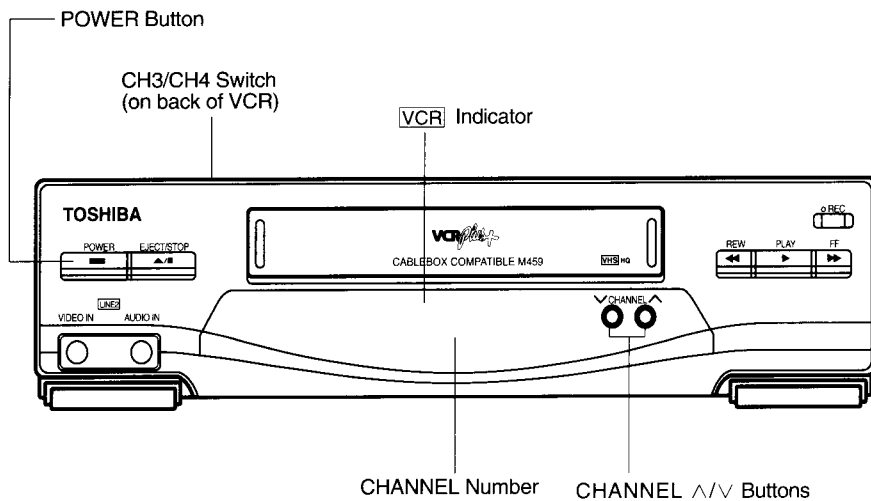

## 5. Turn on the VCR and Select an Active Channel

- Plug in the VCR's power cord and press the **POWER** button on the VCR (the **POWER** button on the remote control) to turn it on.
- Press the **CHANNEL** up or down button to select and active channel in your area. The channel number will appear in the VCR's display panel.

## 6. Set the CATV

- See page 13 for "Auto Channels Program into the channel memory."

## 7. Learn How to Use the TV/VCR Button

Pressing the **TV/VCR** button turns the **VCR** indicator in the display panel on or off. The **VCR** indicator turns on automatically each time you press the **PLAY** button or insert a cassette tape with the safety tab removed.

- When the **VCR** indicator is on, your TV must be tuned to the "VCR Channel" (3 or 4) so you can see what the VCR is doing (unless you have a TV monitor as explained below). The TV then receives the picture from the VCR, and you can select channels with the **CHANNEL** buttons on the VCR (or its remote control).
- When the VCR is turned off (or the **VCR** indicator is off), your TV receives the picture from your home antenna or cable-TV system as it did before you connected the VCR. You can then use the **CHANNEL** buttons on your TV to select channels.
- The **TV/VCR** button lets you record one channel with the VCR while you watch another channel on the TV. *Details are on page 29.*

**Note for TV Monitor:** Whenever the VCR is turned on, you will be able to see what it is doing on the video input channel if you have connected a TV monitor using the **AUDIO** and **VIDEO** jacks. The signal from the VCR on the video input channel will not be affected by turning off the **VCR** indicator. However, be sure to turn off the **VCR** indicator when you are recording one channel on the VCR and want to watch a different channel on the TV.

## 8. Test the VCR Connections

1. Turn on the TV and tune it to the "VCR Channel" (3,4, or video input).
2. Turn on the VCR and select an active channel using the **CHANNEL** buttons on the VCR (or VCR's remote control).
3. If your "VCR Channel" is 3 or 4, make sure the **VCR** indicator is on in the VCR's display panel. Press the **TV/VCR** button to turn it on.

**Note:** If you have connected your VCR to a TV monitor using the **AUDIO** and **VIDEO** jacks, tune your TV to the video input channel. The **VCR** indicator does not have to be on for this connection.

**Test 1:** Make sure the TV's picture and sound are from the channel you have selected on the VCR and of the same quality they were before you connected the VCR. Change channels on the VCR with the **CHANNEL** buttons on the VCR (or the VCR's remote control). If the picture on the TV does not change to the channel you select with the VCR, go back and carefully check the connections and previous steps.

**Test 2:** Turn off the VCR, and change channels on the TV with the TV's **CHANNEL** buttons. Make sure the picture and sound you see on the TV and from the channel you selected on the TV and of the same quality they were before you connected the VCR. If the TV does not operate as it did before you connected the VCR, go back and carefully check the connections.

# FIRST-TIME OPERATION(continued)

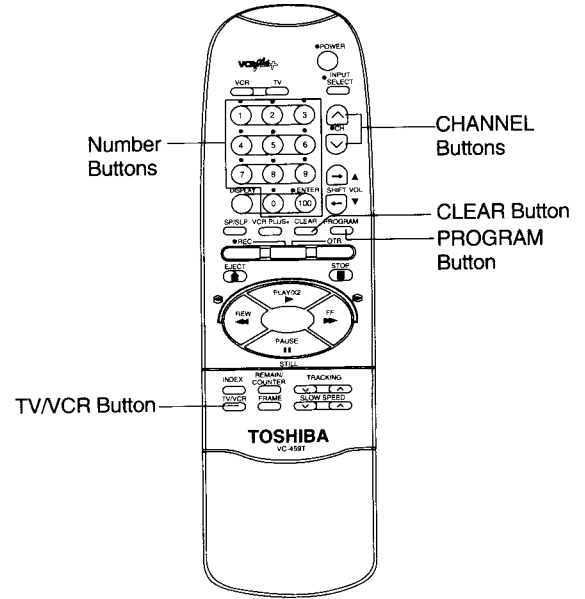
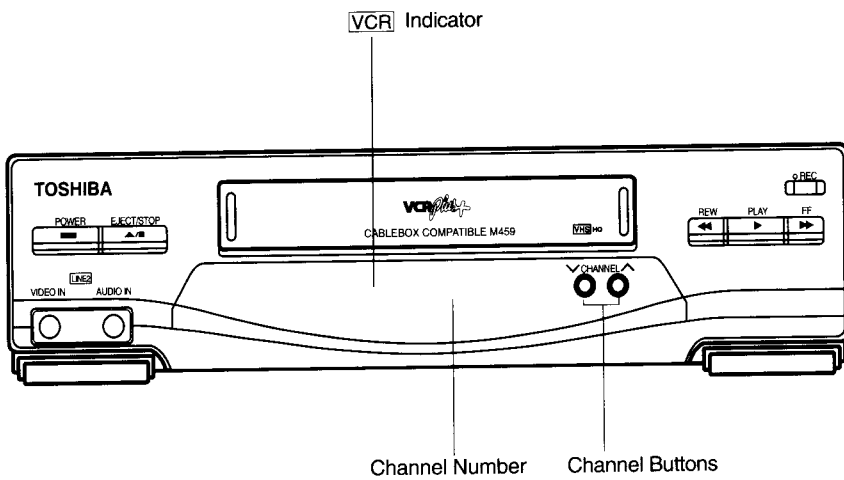

## 9. AutoChannels Program into the Channel Memory

The channel memory is the list of channels your VCR will stop on when you press its *CHANNEL* up or down button. The quickest way to program the VCR's channel memory with channels in your area, is to use the autoprogram feature. The VCR will automatically cycle through all channels and place all active channels into its channel memory for you. You can then add or erase individual channels as desired.

Here is how to start the autoprogramming feature :

1. Make sure the VCR and TV are turned on and the TV is tuned to its "VCR Channel" (3,4 or video input). If you are watching the VCR on channel 3 or 4 of your TV, make sure the **VCR** indicator is on in the VCR's display panel.
2. Press the *PROGRAM* button on the remote control and then press number "3" button to display the following menus.

First Press the  
PROGRAM  
Button

Then  
Press "3"

```

MAIN MENU
1 TIMER PROGRAM
2 CLOCK SET
3 CHANNEL SET
4 VCR FUNCTION SET UP
5 LANGUAGE : → ENGLISH
                ESPAÑOL
                FRANÇAIS

SELECT NUMBER
PUSH PROG TO END
    
```

Then  
Press "1"

```

CHANNEL SET
1 ANT/CABLE: (ANTENNA)
2 AUTO CHANNEL PROGRAM
3 CHANNEL ADD/ERASE
4 VCR plus CHANNEL SET
5 CABLE BOX SET UP

SELECT NUMBER
PUSH PROG FOR MAIN MENU
    
```

3. Before you start AutoProgramming, you must tell your VCR whether you have an antenna or a cable-TV system connected to it. Press number "1" button to change the setting of the ANT/CABLE display.

- If you connected a home-antenna system to your VCR, set this display to ANTENNA.
- If you connected a cable-TV system to your VCR, set this display to CABLE(TV/BOX).

4. After you have selected ANTENNA or CABLE, press number "2" button while the menu appears on the TV to start the VCR autoprogramming itself.

**Note:** The VCR will automatically cycle through all the channel numbers and place only the active channels into its channel memory. This takes about one to two minutes. The channel numbers will stop changing in the VCR's display panel when the autoprogramming is completed.

Autoprogramming is usually a one time procedure. If you move to a new location that has different channels or if power is interrupted for an extended period (about one minute), the channel memory will have to be reprogrammed.

5. After the VCR has finished AutoProgramming you can press the *CHANNEL* up or down button to see what channels are in channel memory.

**Notes:** Occasionally an active channel may be missed if the signal is weak or the channel happens to be "off the air" when the VCR is autoprogrammed.

An inactive channel may be included in channel memory if there is some "noise" or stray signal on the channel during AutoProgramming.

# FIRST-TIME OPERATION(continued)

## 9. Auto Channels Program(continued)

To add or erase channels from channel memory:

1. Press the *PROGRAM* button on the remote control, then press number button "3", then press number button "3". The following menus will appear on the TV screen.

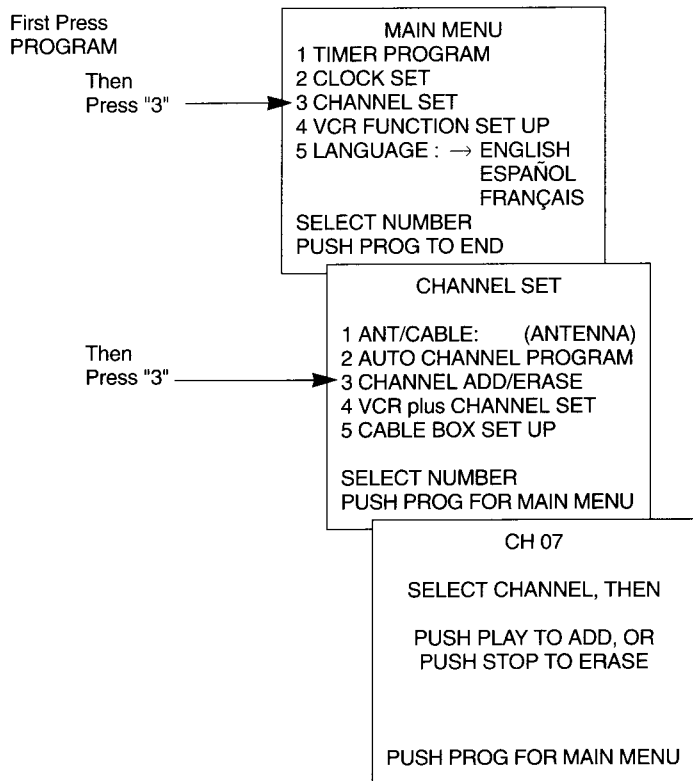

- To add a channel (up to 99) to channel memory, first select the channel you want to add by pressing two number buttons on the remote control. Remember to always press "0" before a single-digit channel number. (For example, press "0" then "8" for channel 8.) Then press the *PLAY* button on the remote control. To add cable-TV channels over 99, press the "100" button and then two number buttons.

- To erase a channel, first press the *CHANNEL* up or down button (or number buttons) to select the channel you want to erase. Then press the *STOP* button on the remote control.

2. When finished, press the *PROGRAM* button on the remote control.

**Note:** You can still select a channel that is not in channel memory by pressing two number buttons for channels up to 99, or the "100" button and two more number buttons for cable TV channels over 99.

## 10. Set the Clock

The clock display area in the VCR's display panel will look like "- : - -" until you set the clock. The clock must be set to the correct time before you can program the VCR for timer recordings. Once the correct time and date are set, the VCR will automatically maintain them unless power is interrupted.

To set the clock press the *PROGRAM* button on the remote control, then press number button "2". The following menu will appear on the TV screen.

When the *CLOCK SET* menu appears, use the number buttons on the remote control to enter the correct time (including *AM* and *PM*) and date as indicated by the flashing portion of the menu on the TV screen.

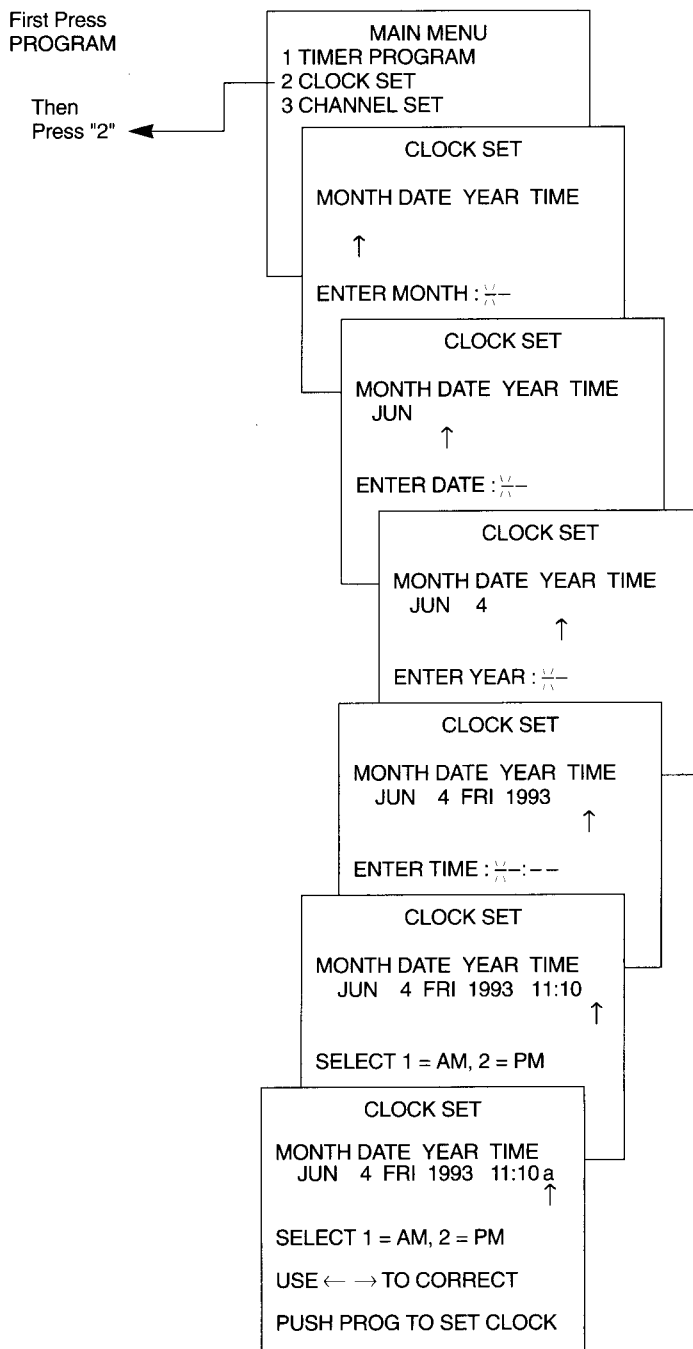

**Notes:** Always press "0" before single-digit hours, minutes, months, or days. For example, to enter a time of 5:07, press "0", the "5" the "0", then "7". To enter august 2, 1993, press "0", then "8", then "0", then "2" then "9", then "3".

# FIRST-TIME OPERATION(continued)

## 11. Make a Recording and Play It Back

Follow the steps below to practice making a short recording and then play it back.

Details on recording speeds, features, and recording guides are on pages 28-42.

Details on playback features and playback guides are on pages 25-27.

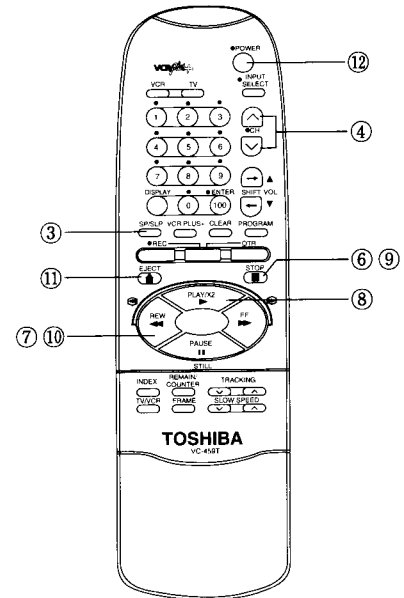
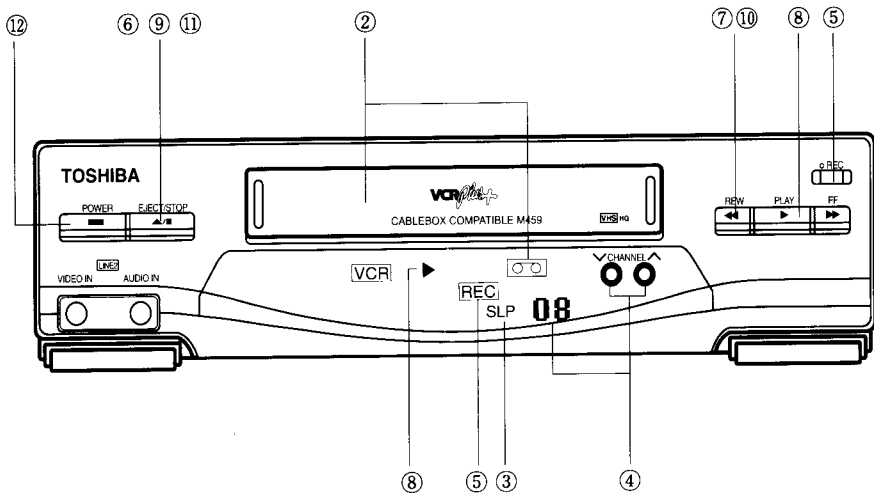

Several buttons on the remote control perform the same function as buttons with the same name on the VCR. You may use whichever button is more convenient at the time.

Details on the operating controls of the VCR and remote control are on pages 17 and 19-20.



### To make a recording :

- ① Turn on the TV and tune it to you "VCR Channel" (3\*, 4\*, or video input).  
\* The TV must be tuned to the same channel you selected with the CH3/CH4 switch on the back of the VCR.
- ② Insert a cassette with the record-protect (safety) tab intact. The cassette-in indicator  will light in the VCR's display panel. *Details about inserting and removing cassettes are on page 24.*  
**Notes:** The VCR is automatically turned on when you insert a cassette.  
  
If you insert a cassette with its record-protect (safety) tab removed, the VCR will automatically begin playback.  
  
If a cassette without a record-protect (safety) tab is inserted, the VCR ejects it when you press the REC button. *Details about the record-protect (safety) tab are on page 24.*  
  
*Make sure the **VCR** indicator appears in the VCR's display panel. If not, press the TV/VCR button to turn it on.*
- ③ Select a tape recording speed by pressing the SP/SLP button. The tape speed indicator (SP or SLP) appears in the VCR's display panel. Use SP for normal recording. Tape recording speeds are compared on page 24.  
**Note:** The VCR automatically selects the correct tape speed for playback.
- ④ Select the channel to be recorded by pressing the CHANNEL  $\wedge$  or  $\vee$  button. The channel number appears in the VCR's display panel and on the TV screen.

- ⑤ Start recording by pressing the REC button. The record indicator ( and ) will light in the VCR's display panel.
- ⑥ When you are finished recording, press the EJECT/STOP button on the VCR (or the STOP button on the remote control).

### To play the recording back:

- ⑦ Rewind the tape by pressing the REW button on the VCR (or the REW button on the remote control). If you do not want to play back the tape, skip to step ⑪.
- ⑧ Press the PLAY button to begin playback. The play indicator () will light in the VCR's display panel.
- ⑨ When you are finished playing back the tape, press the EJECT/STOP button on the VCR (or the STOP button on the remote control).
- ⑩ Rewind the tape by pressing the REW button on the VCR (or the REW button on the remote control).
- ⑪ To eject the cassette, press the EJECT/STOP button on the VCR (or the EJECT button on the remote control).
- ⑫ Turn off the VCR by pressing the POWER button on the VCR (or the POWER button on the remote control).
- ⑬ Turn off the TV.



# VCR'S OPERATING CONTROLS

## VCR Jack Panels

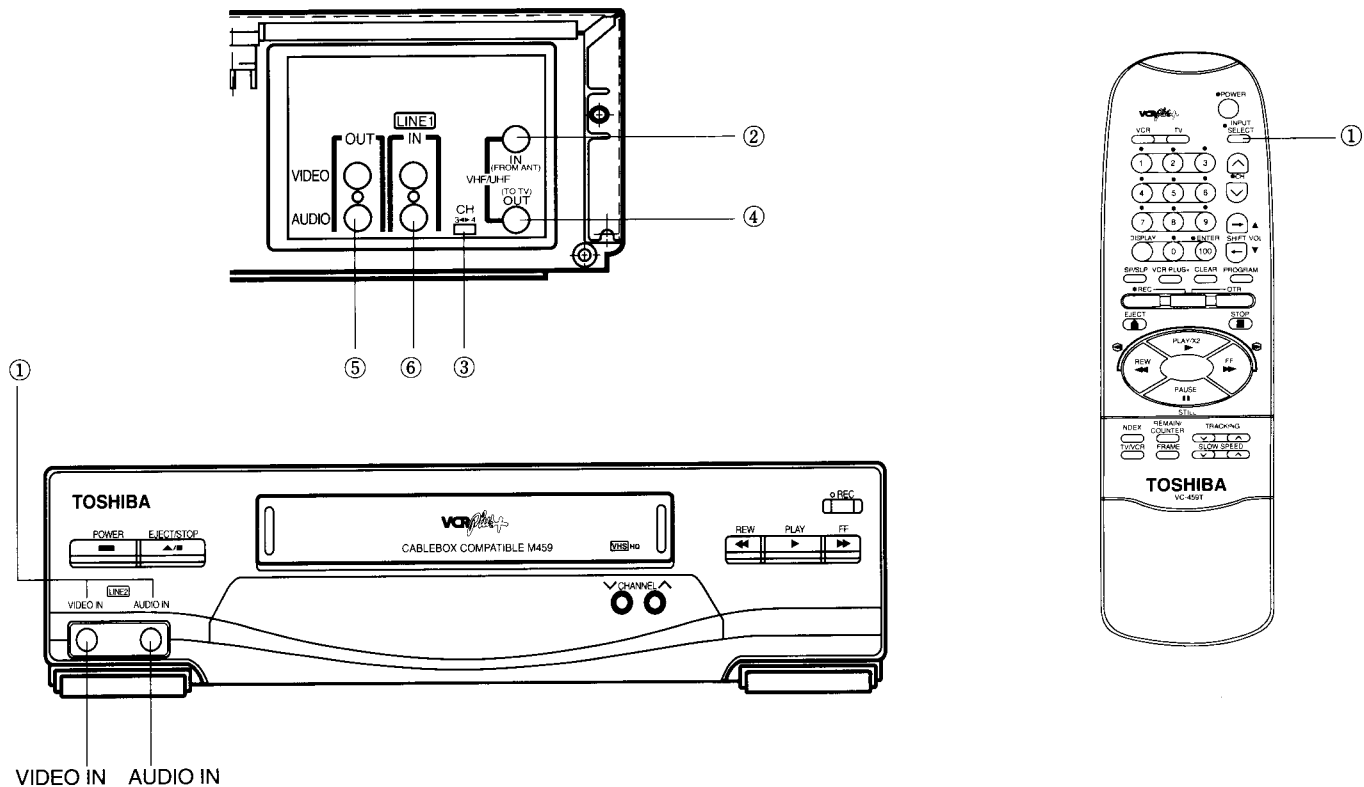

### ① **AUDIO IN** and **VIDEO IN** Jacks of the VCR's front panel

- These jacks are used to receive signals from another device (such as a camcorder or another VCR).
- To see the signal from these jacks, press the **INPUT SELECT** button to light the "L2" in the VCR's display panel.
- At the same time you can find the "LINE2" on the TV screen. Using **INPUT SELECT** button on the remote control.
- See page 41 for "Recording From a Camcorder".
- See page 42 for "Recording From Another VCR".

### ② **IN FROM ANT (Antenna) Connector**

- Attach a home antenna or cable-TV system to this connector.
- See pages 7-10 for home antenna connections.
  - See pages 9-10 for cable-TV connections.

### ③ **CH3/CH4 Switch**

- Whatever channel you select with the CH3 or CH4, switch is the same channel to which you must tune your TV to see what the VCR is doing.
- See page 11 for details.

### ④ **OUT TO TV Connector**

- Connect the supplied VCR coaxial RF cable to this connector. Then connect the cable to your TV.
- See page 7-10 for home antenna connections.
  - See page 9-10 for cable-TV connections.

### ⑤ **AUDIO OUT and VIDEO OUT** Jacks

- These jacks are used to send signals from the VCR to another device.
- See page 42 for "Recording From Another VCR".
- See page 47 for "Copying VCR Recording."

### ⑥ **AUDIO IN** and **VIDEO IN** Jacks of the VCR's rear panel

- It has the same function as explained in ①.
- Note:** To see the signal from these jacks, press the **INPUT SELECT** button to light the "L1" in the VCR's display.

# VCR'S OPERATING CONTROLS(continued)

## VCR's Operating Controls

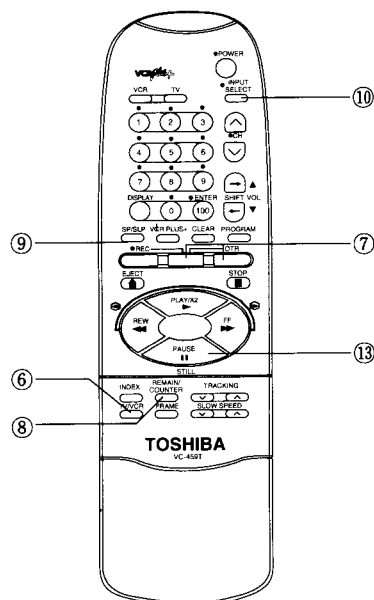
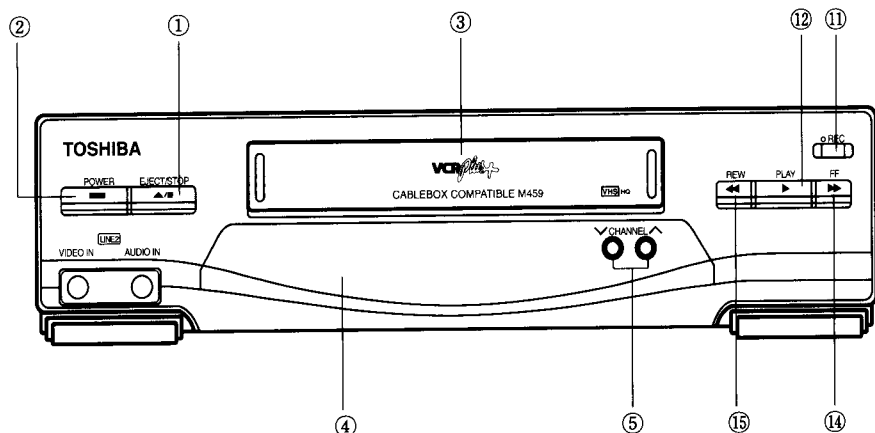

### ① EJECT/STOP Button

- Press this button to stop the normal functions of recording, playback, rewinding, fast-forwarding, recording pause or still.
- Press this button when the VCR is stopped to eject the cassette. (See page 24.)

### ② POWER Button

- Press the *POWER* button to turn the VCR on or off.
- The VCR will stop and turn off if you press the *POWER* button during normal recording, playback, rewind or fast-forward operation.
- If you want to stop a normal timer recording, or one touch recording (OTR), press the *POWER* button.

### ③ Cassette Door (See page 24.)

### ④ Infrared Remote Sensor

This sensor receive signals from the remote control. Aim the remote control at this sensor. There cannot be any obstructions between them.

### ⑤ CHANNEL ▲/▼ Buttons

After channels have been autoprogrammed into the channel memory scan list, press these buttons to select the next higher or lower channel.

- Press *CHANNEL ▲* to select a higher channel.
- Press *CHANNEL ▼* to select a lower channel.

### ⑥ TV/VCR Button

Press the *TV/VCR* button to turn the **VCR** indicator in the VCR's display panel on or off (See page 12.)

### ⑦ OTR (One Touch Recording) Buttons (See page 30.)

### ⑧ REMAIN/COUNTER Button

Press this button to switch between the linear time counter and the remaining amount of tape in a display mode. (See page 46.)

### ⑨ SP/SLP Button (See page 28.)

### ⑩ INPUT SELECT Button

- Press one time to turn on the L1 indicator in the VCR's display panel to record from *AUDIO* and *VIDEO IN* jacks on the VCR's rear panel.
- Press twice to turn on the L2 indicator in the VCR's display panel to record from *AUDIO* and *VIDEO IN* jacks on the VCR's front panel.
- Press again the L1 or L2 indicator in the VCR's display panel for normal recording. (L1=LINE INPUT 1, L2=LINE INPUT 2)

### ⑪ REC Buttons

Press to begin recording. (See pages 28-42.)

### ⑫ PLAY Button

Press to begin playback. (See pages 25-27.)

### ⑬ PAUSE/STILL Button

- Still frame (See page 26.)
- Recording pause (See page 42.)

### ⑭ FF (Fast-Forward) Button

- Press to fast-forward the tape when the VCR is in the stop mode or the forward search mode.
- Press to operate the forward search in the play mode or the fast-forward mode.
- Keep pressing to operate the forward ACCEL search in the play mode or the forward search mode. (See page 26.)

### ⑮ REW Button

- Press to rewind the tape when the VCR is in the stop mode or the reverse search mode.
- Press to operate the reverse search in the play mode or the rewind mode
- Keep pressing to operate the reverse ACCEL search in the play mode or the reverse search mode. (See page 26.)

# VCR'S OPERATING CONTROLS(continued)

## VCR's Display Panel

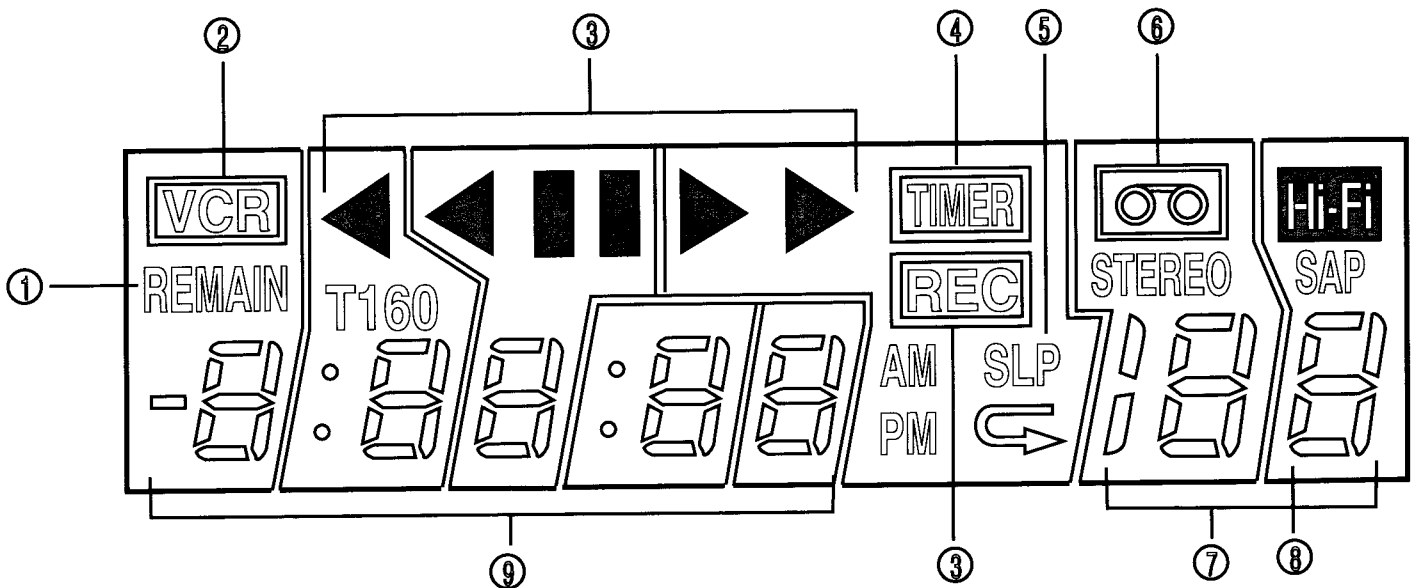

**① REMAIN indicator**

This indicator lights when the display function to indicate the remaining time on the tape is operating.

**② VCR Indicator**  
(See page 12.)

**③ Status Indicators**

This area of the display shows what the VCR is doing.

- [REC] ▶ for record, ▶ for playback, flashing ▶ for double speed playback, ◀◀ for rewind, ▶▶ for fast forward, flashing ▶▶ for forward search and forward ACCEL search, flashing ◀◀ for reverse search and reverse ACCEL search, ■■ and [REC] for record pause, ■■ for still frame, and ■■ and flashing ▶ for frame advance and slow motion.
- This area is blank when the VCR is in the stop mode.

**④ TIMER Indicator**  
(See pages 30-40.)

**⑤ Tape Speed Indicators (SP/LP/SLP)**  
(See page 24.)

**⑥ Cassette-in Indicator**  
The cassette-in indicator lights when a cassette is properly inserted into the VCR. (See page 24)

**⑦ Channel Number Display**

The channel number selected is displayed in this area.

**⑧ LINE Indicator**

Press the *INPUT SELECT* button to turn the "L1(L2)" indicator on or off in the display panel.

- Turn the "L1(L2)" indicator off for normal recording from the VCR's built-in tuner.
- Turn the "L1(L2)" indicator on to record from another component (such as a camcorder or another VCR) connected to the *AUDIO* and *VIDEO IN* jacks on the VCR.

**⑨ Time and Time Counter Display**

Press the *DISPLAY* button on the remote control to switch between the current time and the linear time counter.

- See page 14 for "Set the Clock and Date."
- See page 27 for "Time Counter with Memory-Stop Feature".

**Notes:**

- Those indicators marked multifunctional are sections of the multidisplay which serve a number of purposes. In other words, a number of different symbols appear in the same place according to the buttons you press. This will become clearer as you actually begin using this VCR.

# VCR'S OPERATING CONTROLS(continued)

## Remote Control Buttons that Control the VCR

When using the remote control, always aim it directly at the front of the component you are trying to control. This remote control can control TOSHIBA VCR and a compatible TV.

To operate the remote control, first press one of the component buttons (*TV* or *VCR*) to tell the remote control which component you want to control. The other buttons on the remote control will then

control that component. To control a different component, first press the corresponding (*TV* or *VCR*) button.

Only the buttons that control the VCR are explained here. Buttons that control a compatible TV are explained on pages 21-22.

**VCR Button:** If you press the VCR button, the remote control will go into the "VCR mode" and control the VCR.  
The remote must be in the "VCR mode" before the other buttons will control the VCR.

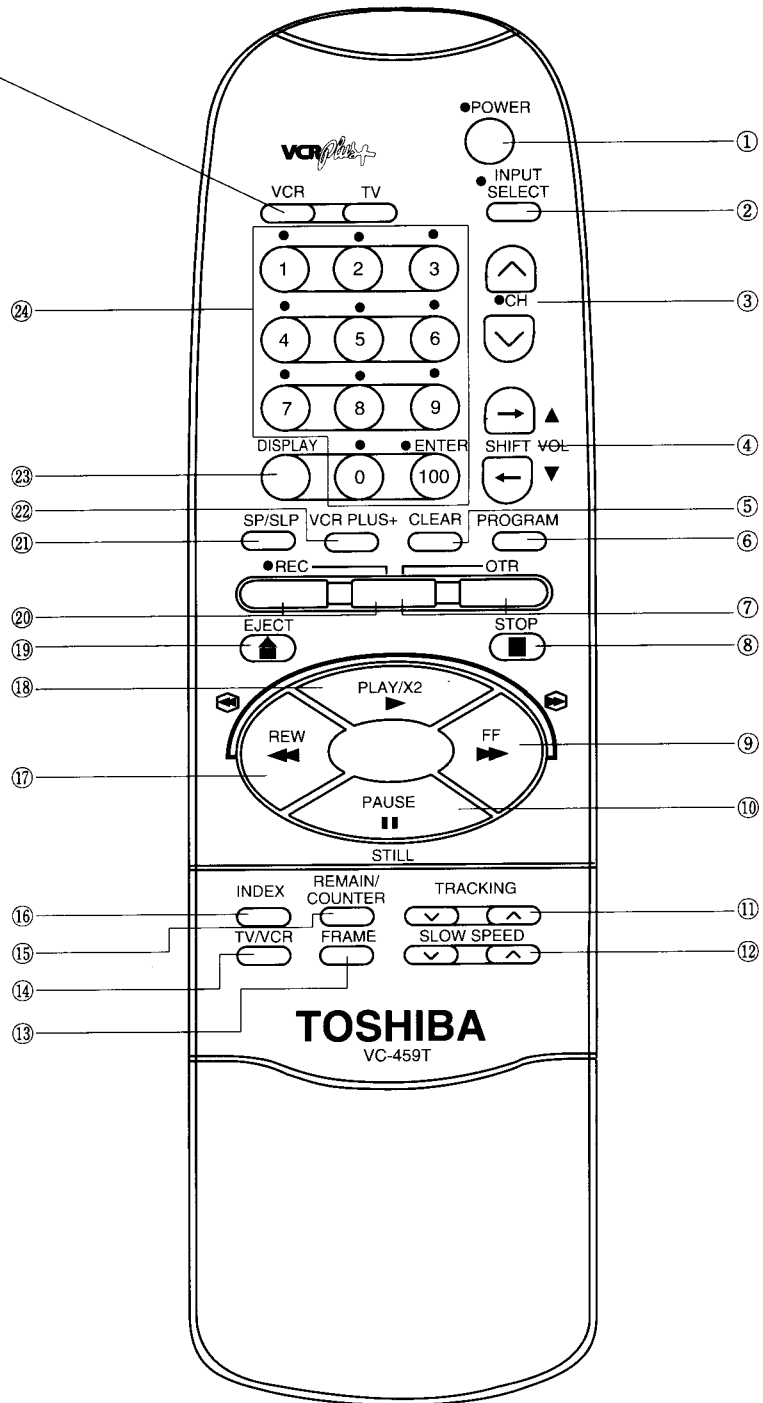

# VCR'S OPERATING CONTROLS(continued)

- ① **POWER Button**
  - Press the **POWER** button to turn the VCR on or off.
- ② **INPUT SELECT Button**

Press to turn the "L1(L2)" indicator on or off in the VCR's display panel. (See pages 17 and 18.)
- ③ **CHANNEL  $\wedge$ / $\vee$  Buttons**

Press the **CHANNEL  $\wedge$**  button to select the next higher channel or press the **CHANNEL  $\vee$**  button to select the next lower channel in the VCR's channel memory. (See pages 13-14.)
- ④ **SHIFT  $\leftarrow$   $\rightarrow$  buttons**

Press to reenter the number or shift the cursor in the OSP menus.
- ⑤ **CLEAR Button** (See pages 13,27 and 31-39.)

Press the **CLEAR** Button to return the counter to 0:00:00 on the screen.
- ⑥ **PROGRAM Button**

Press the **PROGRAM** button to display the program menu on the TV screen for setting the clock, programming the timer, channel set and setting up the VCR.
- ⑦ **OTR (One Touch Recording) Button**
  - Press these OTR buttons to start OTR. (See page 30.)
- ⑧ **STOP Button**

Press this button to stop the normal functions of record, play-back, rewind, fast-forward, record-pause, or still frame.
- ⑨ **FF (Fast-Forward) Button**
  - Press to fast-forward the tape when the VCR is in the stop mode or the forward search mode.
  - Press to operate the forward search in the play mode or the fast-forward mode.
  - Keep pressing to operate the forward ACCEL search in the play mode or the forward search mode. (See page 26.)
- ⑩ **PAUSE/STILL Button**
  - Playback pause (See page 26.)
  - Recording pause (See page 42.)
- ⑪ **TRACKING  $\vee$ / $\wedge$  Buttons**

(See pages 26, 41 and 42.)
- ⑫ **SLOW SPEED Buttons** (See page 26.)
- ⑬ **FRAME (Frame Advance/Skip Search) Button**

(See page 26.)
- ⑭ **TV/VCR Button** (See page 12.)
- ⑮ **REMAIN/COUNTER Button**
  - Press to switch between the linear time counter and the remaining amount of tape in a display mode. (See page 46).
- ⑯ **INDEX Button** (See pages 43-44.)
- ⑰ **REW Button**
  - Press to rewind the tape when the VCR is in the stop mode or the reverse search mode.
  - Press to operate the reverse search in the play mode or the rewind mode
  - Keep pressing to operate the reverse ACCEL search in the play mode or the reverse search mode. (See page 26.)
- ⑱ **PLAY/x2 Button**

Press to begin playback or double speed playback. (See page 26-27)
- ⑲ **EJECT Button**
  - Press to eject the tape in the VCR.
- ⑳ **REC Button**

Press these **REC** and **Dummy** buttons together to start recording. (See pages 28-29.)
- ㉑ **SP/SLP Button** (See page 28.)
- ㉒ **VCR PLUS+ Button** (See page 31-32 and 35-38.)
- ㉓ **DISPLAY Button** (See page 27.)
- ㉔ **Number Buttons ("0" through "9" and "100")**
  - To select any channel up to 99, press two number buttons (ex : To select 9 CH, press 0 9 buttons).
  - To select a cable-TV channel over 99, press the "100" button and then two number buttons (ex : To select 103 CH, press 100, 0, 3 buttons)
  - The number buttons are also used with the VCR's special features.
  - To select channels 100 through 125, the ⑩①② button must be used. Example; press the CH100 button, ② and ④, channel 124 will be selected immediately. If the second digit is not pressed within two seconds, channel "100" will be selected. if the third digit is not pressed within two seconds, channel 102 will be selected.

# VCR'S OPERATING CONTROLS(continued)

## Remote control Buttons That Control a TV

The digital remote control that came packed with your VCR controls your VCR and some functions of a compatible TOSHIBA TV. The remote can also be programmed to control some functions of up to 30 different compatible TV brands (including GE, SONY, MAGNAVOX, SEARS, HITACHI, PANASONIC, MITSUBISHI, RCA and others).

To find out if your TV is compatible, follow the instructions below. If the TV responds to one of the button combinations shown in the chart below, it is compatible.

### Programming the VCR Remote to Control a compatible TV(Other Than TOSHIBA)

Because the remote control is designed to operate 14 different types of TV's (up to 30 different brands), you must first program the remote control to match the remote system of your TV. Follow these four easy steps :

1. Turn on your TV.
2. Point the VCR's remote control toward the front of your TV.
3. Hold down the *TV* button while pressing one of the other buttons shown in the chart below. The TV will change channels when the correct matching button combination is pressed. Try each of the combinations until you find the right one.

4. Release both buttons when the TV start changing channels. Your remote control is now programmed to control your TV.

**Notes:** The remote control is designed to control some functions of up to 30 different brands (including TOSHIBA, GE SONY, MAGNAVOX, SEARS, HITACHI, PANASONIC, and MITSUBISHI). However, it will not operate all TV's made by these manufactures. If your TV does not respond to any of the button combinations, the TV probably cannot be controlled by this remote control.

You may have to re-program the remote control to control a compatible TV (other than TOSHIBA) when you replace the remote control's batteries.

After the VCR's remote control is programmed, it will control certain functions of your TV depending on the type of TV. Keep these exceptions in mind :

- On a TV that has a 12-position knob-type channel selector, you will only be able to select the first ten positions (1 through 10).
- To turn on a compatible TOSHIBA TV, press the *POWER* button. To turn on a different type of compatible TV (after the remote has been programmed), press the *TV* button, then press the *POWER* button.
- Not all functions may be available on your TV. For example, previous channel may not work even through the *CHANNEL*  $\wedge/\vee$  buttons do work.

| Step<br>(continued) | Hold TV button and press these additional buttons to program remote: |          |          |          |          |          |          |
|---------------------|--|----------|----------|----------|----------|----------|----------|
|                     | TV and 1<br>(TOSHIBA)  | TV and 2 | TV and 3 | TV and 4 | TV and 5 | TV and 6 | TV and 7 |

After programming your VCR remote, it wil control the TV function listed below:

| Remote Button                | TV Functions which can be controlled: |                   |                   |                   |                   |                   |                   |
|------------------------------|---------------------------------------|-------------------|-------------------|-------------------|-------------------|-------------------|-------------------|
| <i>TV</i>                    | —                                     | —                 | —                 | —                 | —                 | —                 | POWER ON(RCA)     |
| <i>POWER</i>                 | ON/OFF                                | ON/OFF            | ON/OFF            | ON/OFF            | ON/OFF            | ON/OFF            | ON/OFF            |
| <i>0 THROUGH 9</i>           | 0-9                                   | 0-9               | 0-9               | 0-9               | 0-9               | 0-9               | 0-9               |
| <i>100</i>                   | 100                                   | —                 | ENTRER            | 100               | 100               | —                 | 100               |
| <i>CHANNEL</i> $\wedge/\vee$ | CH $\wedge/\vee$                      | CH $\wedge/\vee$  | CH $\wedge/\vee$  | CH $\wedge/\vee$  | CH $\wedge/\vee$  | CH $\wedge/\vee$  | CH $\wedge/\vee$  |
| <i>VOL</i> $\wedge/\vee$     | VOL $\wedge/\vee$                     | VOL $\wedge/\vee$ | VOL $\wedge/\vee$ | VOL $\wedge/\vee$ | VOL $\wedge/\vee$ | VOL $\wedge/\vee$ | VOL $\wedge/\vee$ |
| <i>INPUT SELECT</i>          | TV/VIDEO                              | —                 | TV/VIDEO          | —                 | —                 | —                 | TV/VIDEO          |

| Step<br>(continued) | Hold TV button and press these additional buttons to program remote: |          |          |                                   |                                 |            |                               |
|---------------------|--|----------|----------|-----------------------------------|---------------------------------|------------|-------------------------------|
|                     | TV and 8   | TV and 9 | TV and 0 | TV and<br><i>CHANNEL</i> $\wedge$ | TV and<br><i>CHANNEL</i> $\vee$ | TV and 100 | TV and<br><i>INPUT SELECT</i> |

After programming your VCR remote, it wil control the TV function listed below:

| Remote Button                | TV Functions which can be controlled: |                   |                   |                   |                   |                   |                   |
|------------------------------|---------------------------------------|-------------------|-------------------|-------------------|-------------------|-------------------|-------------------|
| <i>POWER</i>                 | —                                     | —                 | —                 | —                 | —                 | —                 | —                 |
| <i>0 through 9</i>           | ON/OFF                                | ON/OFF            | ON/OFF            | ON/OFF            | ON/OFF            | ON/OFF            | ON/OFF            |
| <i>100</i>                   | K, A-I                                | 0-9               | 0-9               | 0-9               | 0-9               | 0-9               | 0-9               |
| <i>CHANNEL</i> $\wedge/\vee$ | —                                     | 100               | 100-              | —                 | —                 | ENTRER            | —                 |
| <i>VOL</i> $\wedge/\vee$     | L/J                                   | CH $\wedge/\vee$  | CH $\wedge/\vee$  | CH $\wedge/\vee$  | CH $\wedge/\vee$  | CH $\wedge/\vee$  | CH $\wedge/\vee$  |
| <i>INPUT SELECT</i>          | VOL $\wedge/\vee$                     | VOL $\wedge/\vee$ | VOL $\wedge/\vee$ | VOL $\wedge/\vee$ | VOL $\wedge/\vee$ | VOL $\wedge/\vee$ | VOL $\wedge/\vee$ |
|                              | —                                     | TV/VIDEO          | —                 | TV/VIDEO          | TV/VIDEO          | TV/VIDEO          | —                 |

# VCR'S OPERATING CONTROLS(continued)

## Controlling a TV with the Remote Control

Only the remote control buttons that are used to control compatible television are described on this page. The buttons that are used to operate the VCR are described on pages 19-20.

If you have a compatible TV (other than TOSHIBA) you must program the remote control as described on the previous page before these buttons will operate your TV.

Depending on the specific features of your TV model, some of these controls may not apply to your TV. Check the chart to see which controls apply to your type of TV.

Most of the buttons (except *VOL*  $\wedge/\vee$ ) will not control your TV unless the remote control is in the "VCR mode". If you press the *VCR* button, the remote control will go into the "VCR mode" and control the VCR. Press the *TV* button to return the remote control to the "TV mode" so it will control the TV.

**Important Note:** When you press the *TV* button, this remote will automatically control your TOSHIBA TV. If your TOSHIBA TV stops responding to this remote, you may have accidentally pressed the buttons to program it for a different brand. To control your TOSHIBA TV again, press the *TV* button and number button "1" together as described on the previous page.

### ① *TV* Button

- Press the *TV* button to put the remote control in the "TV mode", and then press the *POWER* button to turn on a TV.

### ② *POWER* Button

- Press the *TV* button to put the remote control in the "TV mode", and then press the *POWER* button to turn on a compatible TV. The remote control must be programmed to operate a compatible TV (TOSHIBA or other).
- Press *POWER* to turn off as compatible TV (TOSHIBA or other) when remote is in "TV mode"

### ③ *INPUT SELECT* Button

This button has the same function as some compatible TV's remote control *TV/VIDEO* button when the remote control is in the "TV mode".

### ④ *CHANNEL* $\wedge/\vee$ Buttons

- The remote control must be in the "TV mode" (press *TV* button) to use the *CHANNEL*  $\wedge/\vee$  buttons for your TV.
- If your TV has a channel memory scan list, press *CHANNEL*  $\wedge$  to see the next higher channel in memory.
  - Press *CHANNEL*  $\vee$  to see the next lower channel in memory.

Press the *TV* button to put the remote control in the "TV mode".

Press the *TV* button and then the *POWER* button to turn on a TV.

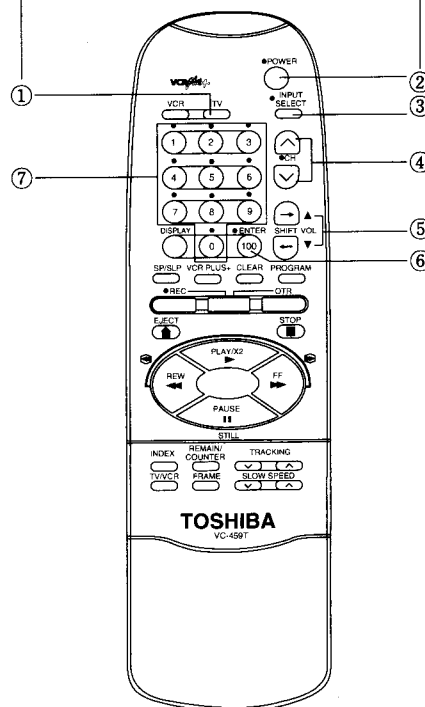

### ⑤ *VOLUME* $\wedge/\vee$ Buttons

- Press *VOLUME*  $\wedge$  to increase the volume.
- Press *VOLUME*  $\vee$  to decrease the volume.

### ⑥ *100 CH* Button

This button has the same function as some compatible TV's remote control *100 CH* or *ENTER* button when the remote control is in the "TV mode".

### ⑦ *Number Buttons* ("0" through "9" and "100")

The remote control must be in the "TV mode" (press *TV* button) to change channels on the TV.

- Press two number buttons to select any channel (up to channel 99). For example, press "0" then "8" to select channel 8.
- Press the "100" button and then two number buttons to select any cable-TV channel over 99. For example, press "100" then "0" then "8", to select channel 108.

# VCR FEATURES

## Quick-Play Feature

The quick-play feature eliminates the "delay" when you begin recording or playing back a tape. The VCR automatically positions the tape for "action" whenever a cassette is inserted or when the VCR is turned on with a cassette already inserted.

The VCR also keeps the tape "ready" when you place the VCR in the stop mode. After you have placed the VCR in the stop mode, you will hear the cylinder head inside the VCR continue to rotate for about five minutes while the VCR is "waiting" for you to select the next function. After five minutes, the cylinder head will stop rotating and you will no longer hear it.

## High-Speed Rewind and Fast Forward

This VCR has a high-speed rewind and fast forward feature which eliminates the long wait while the tape is rewinding.

## Auto Head Cleaner

This VCR is equipped with an automatic Video Head Cleaner. This feature will ensure that your VCR will perform at its best by keeping the video heads clean of dirt that can distort picture quality. The Auto Head Cleaner engages automatically each time a tape is inserted or ejected.

## Three Language Menus

This VCR gives you complete control of all functions, programs, and displays, in either English or Spanish or French.

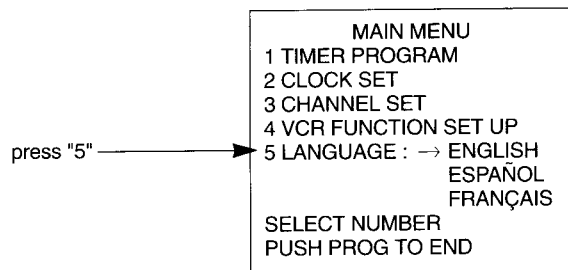

## VCR FUNCTION SET UP Menu

Your VCR allows remote control adjustment of several additional feature options. You can use the VCR SET UP menu to select the functions that best fit your personal needs.

To display this menu, press PROGRAM, then press "4" on the remote control.

The TAPE TYPES, COUNTER MEMORY, REPEAT PLAY and EDIT features in the VCR FUNCTION SET UP menu are necessary for initial installation of your VCR and are described on pages 13-14.

First Press PROGRAM

Then  
press "4" →

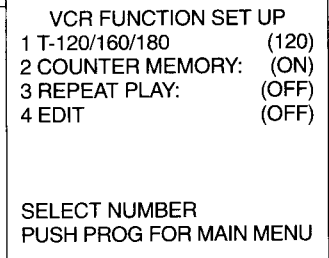
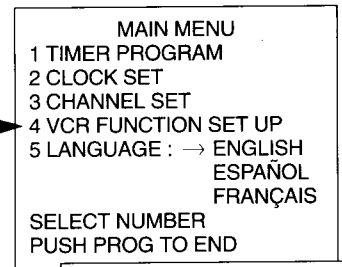

Set the following items respectively.

1. T-120/160/180 : See page 46.
2. COUNTER MEMORY : See page 27.
3. REPEAT PLAY : See page 45.
4. EDIT : See page 47.



# VIDEO CASSETTES

Use of poor quality tape or tapes that have been damaged or mishandled can contaminate the VCR heads. This can cause a snowy picture or a missing picture during playback. If a snowy picture or missing picture condition persists, consider the use of a chemical non-abrasive head cleaning tape.

## Tape Speed

**Recording:** Tapes can be recorded at two different speeds, SP (Standard Play : records 3.34 cm/sec.) and SLP (Super Long Play : 1.11 cm/sec.) you select the speed you prefer using the SP/SLP button. Selected speed mode will show up on the TV screen. The basic difference between these speeds is that the SLP mode allows you to get more footage on your tape. Although this is economical, the quality of the image is not as good as recordings made in the SP mode.

**Playback:** There are three possible speeds for playback; SP, LP, SLP. The appropriate speed will be chosen automatically by the VCR.

## Applicable Speeds

| Speed \ Mode | SLP | LP | SP |
|--------------|-----|----|----|
| Recording    | ○   | X  | ○  |
| Playback     | ○   | ○  | ○  |

## Different types of cassettes and maximum recording times

| Video Cassette Record Mode | T-180  | T-160  | T-120  | T-60   |
|----------------------------|--------|--------|--------|--------|
| SLP                        | 540min | 480min | 360min | 180min |
| SP                         | 180min | 160min | 120min | 60min  |

## Erasing Tapes

You can use your video cassettes over and over again. To erase a previous recording, just record over it.

## Erase Protection-Record-Protect (Safety) Tab

To prevent erasing a recording you want to keep, remove the record-protect (safety) tab from the back of the cassette as shown below. Recording is impossible when this tab is removed. To record again on a cassette that has the removed, simply cover the hole with vinyl tape.

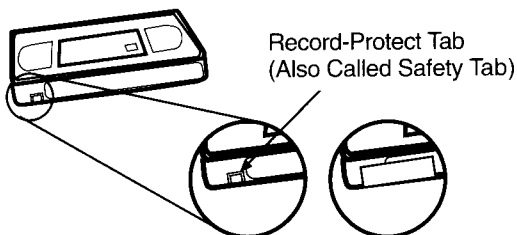

To prevent erasure, break off the tab.

To record again, cover the hole with vinyl tape.

## Inserting and Removing Cassettes

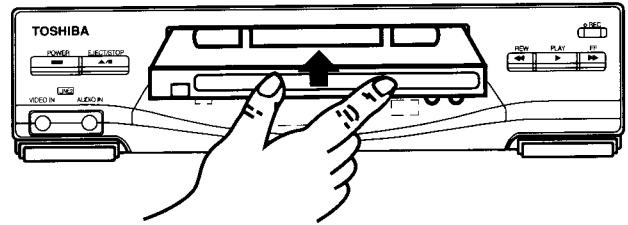

**Insert a Cassette.** Push the cassette gently through the door of the cassette compartment until the VCR mechanism pulls it into the VCR. Inserting a cassette will automatically turn on the VCR's power. The cassette-in indicator (  ) will light when a cassette is properly inserted into the VCR.

**Caution:** Insert a cassette only one way with the tape windows facing up, and the record-protect (safety) tab facing out.

EJECT/STOP Button

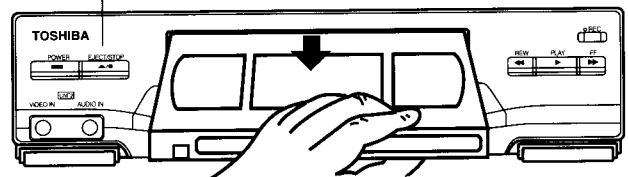

**Eject and remove a cassette.** The VCR must be in the stop mode. Press the *EJECT/STOP* button to eject the cassette. The cassette is partially ejected automatically by the VCR. Gently pull the cassette straight back out of the compartment. Place the cassette in its case and store it upright.

## Cassette Care and Storage

Follow these directions for continued high-quality performance from your cassettes.

- When you are finished with a cassette, rewind it and remove it from the VCR.
- Never attempt to force open the cassette door.
- Store cassettes vertically in their protective cases at normal room temperatures. Avoid extreme heat and humidity. Extreme heat can warp the cassette or cause the tape to stretch excessively.
- Be especially careful to keep dust from entering the cassette and the VCR mechanism. All dust is abrasive, and it will cause excessive wear of both the tape and the VCR's recording/playback heads.

# PLAYBACK

Follow the steps below to play back a tape in the VCR. The VCR will automatically select the correct playback speed and the appropriate indicator will light in the VCR's display panel.

Some of the buttons on the VCR and remote control operate differently during playback. These special playback features are described on the following pages.

## Playback Guide

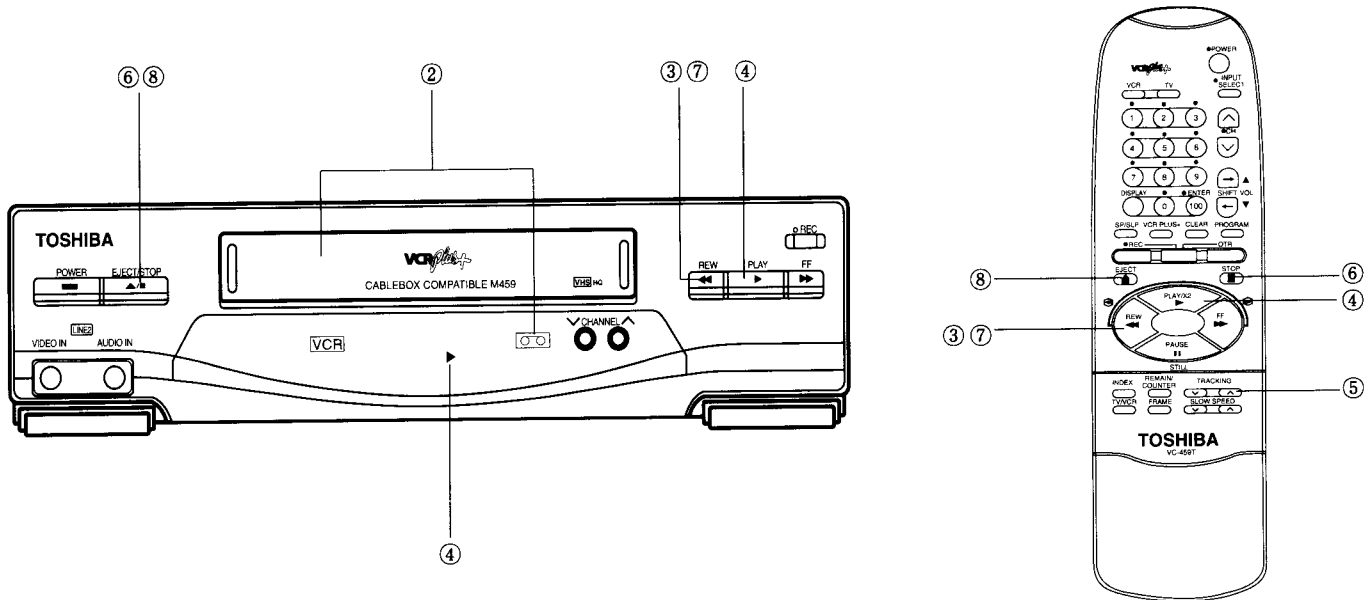

- ① Turn on the TV and tune it to the "VCR Channel" (3\*, 4\* , or video input).  
\* The TV must be tuned to the same channel you selected with the CH3/CH4 switch on the back of the VCR.
- ② Insert a cassette in the VCR. (The cassette-in indicators will light.)  
**Note:** The tape will automatically begin playback if the record protect (safety) tab on the cassette has been removed.
- ③ To rewind the tape if necessary, press the *REW* button on the VCR ( or the *REW* button on the remote control).
- ④ To begin playback, press the *PLAY* button. The play indicator (▶) appears in the display panel.
- ⑤ Adjust tracking if necessary. If the tape was recorded on a different VCR, streaks may appear. Press the *TRACKING* ^ or v button on the remote control to move the streaks up or down and out of the picture. *Details are on page 26.*
- ⑥ When you are finished, press the *EJECT/STOP* button on the VCR (or the *STOP*) button on the remote control).
- ⑦ To rewind the cassette, press the *REW* button on the VCR (or the *REW* button on the remote control)
- ⑧ To eject the cassette from the VCR, press the *EJECT/STOP* button on the VCR (or the *EJECT* button on the remote control) when it is in all mode except the record mode.

# PLAYBACK(continued)

## Picture Search

During playback, the rewind, (*REW*) and fast forward (*FF*) buttons are used for visual searching of the tape.

- During playback, press and quickly release the *FF* button to visually search forward at 5 times normal speed. To return to normal playback, press the *PLAY* button again.
- During playback, press and quickly release the *REW* button to visually search backwards at 5 times normal speed. To return to normal playback, press the *PLAY* button again.

The sound is turned off during visual searching because it would not be understandable at such high speed.

Expect to see some horizontal lines or bars in the picture when you are using the search mode. The picture will be best for tapes recorded at SP or SLP speeds, although tapes recorded at LP speed can be viewed.

## Accel Search

If you keep pressing the *FF* or *REW* button during playback, the searching speed will be increased to 9 times ( SP speed only ) or 27 times ( SLP speed only ) normal speed.

## Double speed Playback

If you press *PLAY* button during normal playback, the picture will be viewed in double speed.

Press *PLAY* button once more to return to the normal playback.

## Variable Speed Slow-Motion Playback

During playback, the tape can be viewed in slow motion at variable speeds.

- Press the *SLOW SPEED* button on the remote control when a tape is playing to start slow-motion playback. Press the *PLAY* button to return to normal playback.
- During slow-motion playback, you can change the speed by pressing the *SLOW SPEED*  $\wedge$  or  $\vee$  button on the remote control. Press the *SLOW SPEED*  $\wedge$  to increase the speed or *SLOW SPEED*  $\vee$  to decrease the speed.

It is normal to see some streaks in the picture during slowmotion playback. Press the *TRACKING*  $\wedge$  or  $\vee$  button on the remote control to move the streaks up or down and out of the picture.

The VCR will automatically switch from slow-motion to after about five minutes.

Slow-motion playback is designed to work at the SP and SLP speeds, For the longest recording time, SLP speed is recommended.

## Still for Stop-Action Playback

- Press the *PAUSE/STILL* button during playback to freeze the picture. This lets you examine all the details of the scene, similar to looking at a single frame of a movie film.

- When you are ready to resume normal playback, press the *PAUSE/STILL* button again.
- Still frame is designed to work best at the SP and SLP speed.
- If the picture "jitters" (bounces up and down) during still, press one of the *TRACKING*  $\wedge$  or  $\vee$  buttons located on the remote control to reduce the "jitter".

**Caution:** Using still frame on a single frame of the picture for a long time can wear the tape. Use *STOP* instead of *STILL* to interrupt playback for an extended time. The VCR will automatically switch from pause to stop after about five minutes.

## Frame(Frame Advance)

Frame advance lets you view one still frame after another.

- Press the *STILL* button to begin stop-action viewing. Then press the *FRAME* (frame advance) button on the remote control each time you want to view the next frame for the scene. Press the *PLAY* button to resume playback at normal speed.
- Frame advance is designed for use on tape recorded in SP or SLP speed. It may be used on tapes recorded in LP, but the picture quality not be as good.

## Tracking(Automatic and Manual)

The VCR has a built-in digital automatic tracking feature and there are manual *TRACKING* buttons on the remote control.

### Digital Auto Tracking

The VCR automatically adjusts the tracking for rental tapes or tapes recorded on other VCRs or camcorders.

- Every time you insert a tape and press the *PLAY* button, the VCR's digital auto tracking is turned on and tracking is adjusted.
- If you press one of the manual *TRACKING* buttons on the remote control, the digital auto tracking feature is turned off.

### Manual Tracking (*TRACKING* $\vee$ and $\wedge$ Buttons)

Tracking can be adjusted manually by pressing the *TRACKING*  $\vee$  or  $\wedge$  button on the remote control. The VCR's digital auto tracking is turned off whenever you press-the *TRACKING*  $\vee$  or  $\wedge$  button.

- During still playback, press the *TRACKING*  $\wedge$  or  $\vee$  button to reduce picture "jitter" (bouncing up and down). A small amount of "jitter" or some "streaks" are normal during still viewing.
- During slow-motion playback, it is normal to see some streaks (noise bars) in the picture. If the streaks interfere with the time counter display on the TV screen, press the *TRACKING*  $\wedge$  or  $\vee$  button to move the streaks up or down.

---

### Note :

- When a tape recorded with some other VCR is played back at slow, still frame, noise may not be eliminated even by *TRACKING* control.
-

# PLAYBACK(continued)

## On-Screen Displays

The VCR's on-screen displays appear automatically on the TV whenever you turn on the VCR or change the VCR's status (stop to play, play to stop, change channels, etc.). The VCR's on-screen displays, the time counter can be manually displayed by pressing the *DISPLAY* button on the remote control.

- Press the *DISPLAY* button once to display the normal displays on the TV screen.
- Press the *DISPLAY* button again (while the normal displays still appear on the TV screen) to display only the time counter on the TV screen. The time counter will remain on the TV screen.
- Press the *DISPLAY* button again, to display only the remain counter on the TV screen.

**Note:** Whenever the time counter with memory appears on the TV screen, the time counter's memory stop feature is automatically turned on.

- Press the *DISPLAY* button again to remove all displays from the TV screen.

## Time Counter with Memory-Stop Feature

First press PROGRAM

Then  
press "4"

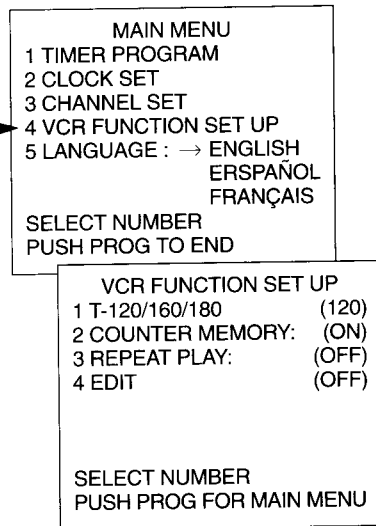

The time-counter display shows the actual linear time it takes to record a program or play back a segment of a prerecorded tape. It helps you quickly locate the end of programs you taped. For example, if you recorded a 3-minute program at one segment of the tape, you will be able to stop the tape, display the time counter with memory, and rewind the tape until the time counter reads "0:00:00M" on the TV screen (in the VCR's display panel). This will be the approximate start position of your 3-minute recording.

You can note the time-counter with memory reading at one beginning of each recorded program.

- If the current time appears in the VCR's display panel, press the *DISPLAY* button twice to switch the current time display to the time-counter display.
- Then, press the *DISPLAY* button again to display the remain counter on the TV screen.

Whenever the time counter with memory is displayed, press the *CLEAR* button on the remote control to set the time counter to a reading of "0:00:00M"

**Notes:** The time counter is automatically reset to "0:00:00" in the VCR's display panel whenever the tape is ejected from the VCR.

If you rewind the tape farther back than a counter reading of "0:00:00", a minus(-) will appear in front of the time.

## Memory-Stop Feature (Zero Return)

The memory-stop feature allows you to quickly return to a counter reading of "0:00:00" from any point on the tape. Memory stop is automatically turned on whenever the time counter with memory is displayed on the TV screen. This is convenient when you want to watch a segment of the tape repeatedly. You may also discover other useful applications for this feature.

1. Whenever you are at a spot on the tape that you want to return to quickly, press the *CLEAR* button to reset the counter to "0:00:00M" at the spot.
2. Later, after you have moved somewhere else on the tape, you can quickly return to your original spot (where you set the counter to "0:00:00M") by pressing the *STOP* and then the *REW* or *FF* (fast-forward) button. Make sure the "M" is displayed if you want the VCR to stop at "0:00:00".

**Notes:** If you are rewinding the tape and the VCR stops at "0:00:00M", press *REW* again to continue rewinding.

If you press the *FF* (fast-forward) button and the time counter never reaches "0:00:00M" between that point and the end of the tape, the VCR will continue to fast-forward to the end of the tape, switch to rewind, and then stop when the counter reaches "0:00:00M".

# RECORDING

## Recording Guides

The guides on these two pages show you how to make recordings on the VCR.

- The guide on the bottom of this page shows you how to record on the VCR with the TV turned off.
- The first guide on the next page shows you how to record a program on the VCR and watch the same program on the TV.
- The second guide on the next page shows you how to record one program on the VCR while watching a different program on the TV.

This VCR also features One Touch Recording (OTR), timer recording, and VCR Plus+ recording. It will turn itself on, make a recording, and turn itself off while you are away.

- Details on One Touch Recording (OTR) are on page 30.
- Details on timer recording are on pages 31-34.
- Details on VCR Plus+ are on pages 31-32, 35-38.

## PAUSE/STILL Button

Use this button to stop recording temporarily. This enables you to skip recording unnecessary parts of a program (such as commercial messages.)

1. Press the *PAUSE/STILL* button during recording and recording is stopped temporarily. However, since the TV continues operating, the pictures and sound of the program can be received.
2. Press the *PAUSE/STILL* button to resume recording.

**Note:** If the VCR pauses for more than five minutes, it automatically enters the stop mode to protect the tape.

## Recording With TV Turned Off

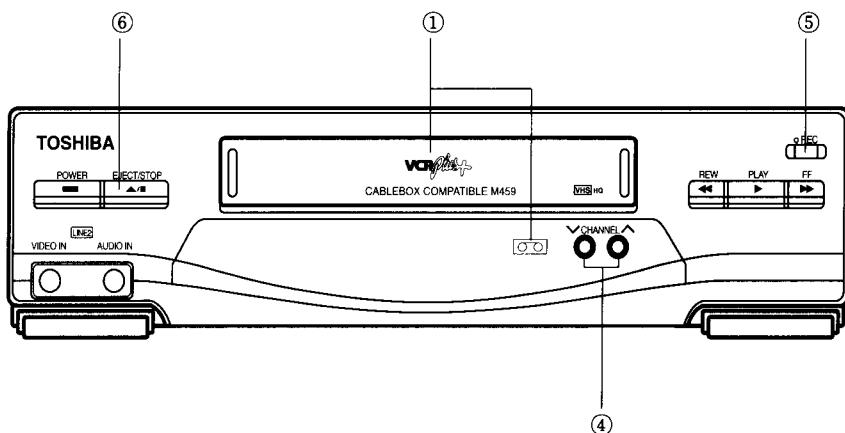

- ① Insert a cassette with the record-protect (safety) Tab intact. (The cassette-in indicator will light.)
- ② Press the *SP/SLP* button to select a recording speed. The Tape speed indicator (*SP* or *SLP*) will appear.
- ③ Make sure the "L1(2)" indicator does not appear in the VCR's display panel unless you want to record from the VCR's *AUDIO* and *VIDEO IN* jacks. If "L1(2)" appears, press the *INPUT SELECT* button to turn it off.

## Tape Recording Speeds

To select one of the VCR's two recording speeds, press the *SP/SLP* button. The appropriate indicator (*SP* or *SLP*) will appear in the VCR's display panel. The information below will help you decide which tape speed to use when recording.

**Notes:** The VCR automatically selects the appropriate tape speed for playback.

Your VCR's special effects (still-frame and search) are designed for optimum performance at the *SLP* speed.

We recommend *SLP* speed for the longest recording time.

- *SP* (Standard play) provides the best picture but the shortest recording time (2 hours with a T-120 tape). Video recorded at this speed has the least picture noise (snow) in normal play back.
- *SLP* (Super Long Play) provides three times the recording time as *SP* (6 hours with a T-120 tape). *SLP* has slightly more picture noise (snow) than *SP* in normal playback. This may not be noticeable.

Press VCR button to put remote in "VCR" mode"

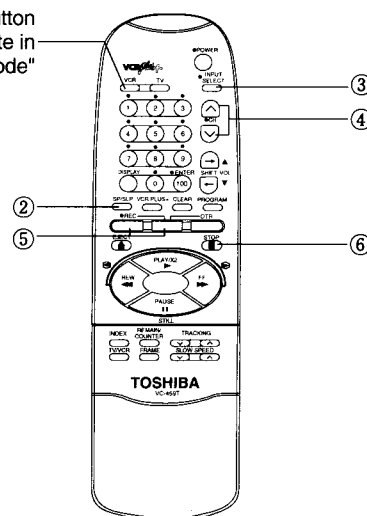

- ④ To select the channel you want to record, press the *CHANNEL*  $\nabla$  or  $\wedge$  button until channel number you desire appears.
- ⑤ To start recording, press the *REC* button. The record indicator appears in the VCR's display panel.
- ⑥ When you finished, press the *EJECT/STOP* button on the VCR (or the *STOP* button on the remote).

# RECORDING(continued)

## Recording and Viewing the Same Program

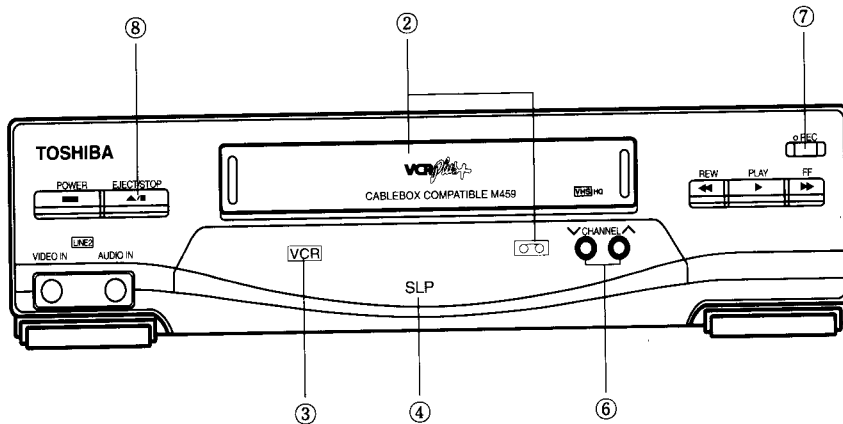

Press VCR button to put remote in "VCR" mode"

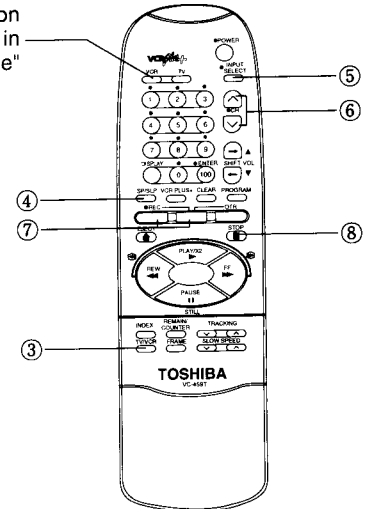

- ① Turn on the TV and tune it to the "VCR Channel" (3\*, 4\* or video input).  
\* The TV must be tuned to the same channel you selected with the CH3/CH4 switch on the back of the VCR.
- ② Insert a cassette with the record-protect (safety) tab intact. (The cassette-in indicator will light).
- ③ Make sure the **VCR** indicator appears in the VCR's display panel. If it does not appear, press the TV/VCR button to turn it on.
- ④ Press the SP/SLP button to select a recording speed. The tape speed indicator (SP or SLP) will appear.
- ⑤ Make sure the "L1(2)" indicator does not appear in the VCR's display panel unless you want to record from the VCR's AUDIO and VIDEO IN jacks. If "L1(2)" appears, press the INPUT SELECT button to turn it off.
- ⑥ Press the CHANNEL  $\nabla$  or  $\blacktriangle$  button to select the channel you want to record. (The channel number appears in the VCR's display panel.)
- ⑦ Press the REC button to start recording. (The recording indicator appears in the VCR's display panel.)
- ⑧ Press the EJECT/STOP button on the VCR (or the STOP button on the remote control) When you are finished.

## Recording and Viewing Different Programs

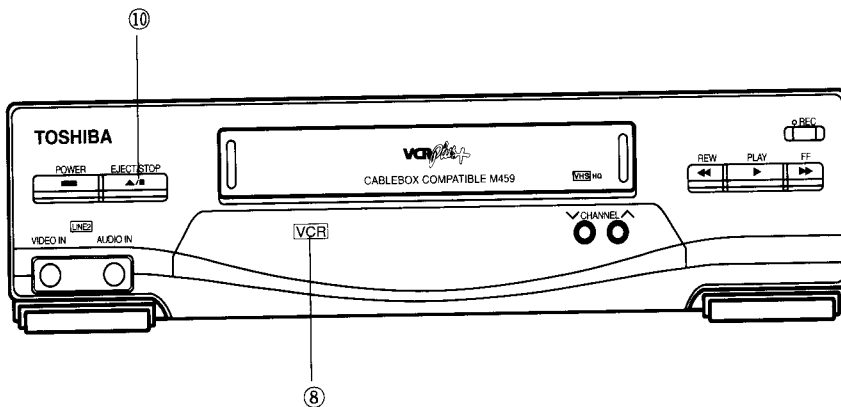

Press VCR button to put remote in "VCR" mode"

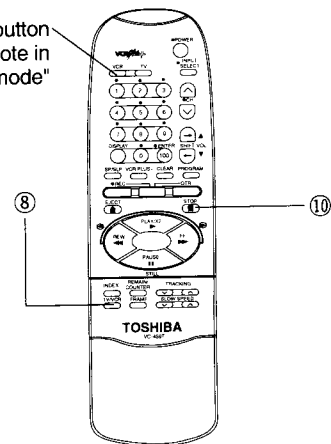

To record one program on the VCR and watch different program on the TV, follows steps ① through ⑦ above and then :

- ⑧ Press the TV/VCR button to turn off the **VCR** indicator.
- ⑨ Select the other channel you want to watch with the TV's channel buttons.
- ⑩ Press the EJECT/STOP button the VCR (or the STOP button on the remote control) when you are finished.

**Note:** If you want to watch what the VCR is recording, press the TV/VCR button to turn on the **VCR** indicator. Then tune your TV to the "VCR Channel" (3,4, or video input).

### Notes:

- Basic Manual Recording is possible only in the SP and SLP modes.
- The recorded pictures on the tape may be distorted around where the PAUSE/STILL button is used. This is not a malfunction.
- Since channel lock function operates during recording. TV channels cannot be changed directly. To change the channel, press the PAUSE/STILL button first. If the PAUSE/STILL button is pressed again, a TV program in a new channel can be recorded.

# RECORDING(continued)

## One Touch Recording (OTR)

One Touch Recording (OTR) lets you record up to four hours without programming the timer. It also allows you to start (or continue) recording immediately.

*When the recording is finished, the VCR will turn off automatically.*

**Note:** The clock doesn't have to be set before you can do One Touch Recording.

Only two buttons on the remote control are used to do One Touch Recording.

### Immediate Start

- If you want the VCR to start recording immediately or to continue a recording you have already started, *follow the simplified instructions below or the detailed instructions on the right-side page.*
- Only the *OTR* buttons are used for immediate One touch Recording. Each time you press the *OTR* buttons the recording time is extended.

|                 |                            |
|-----------------|----------------------------|
| 1st press ..... | 30 minutes OTR             |
| 2nd press ..... | 1 hours OTR                |
| 3rd press ..... | 1-1/2 hours OTR            |
| 4th press ..... | 2 hours OTR                |
| 5th press ..... | 2-1/2 hours OTR            |
| 6th press ..... | 3 hours OTR                |
| 7th press ..... | 3-1/2 hours OTR            |
| 8th press ..... | 4 hours OTR                |
| 9th press ..... | Return to normal recording |

## Simplified Instructions for Immediate-Start

1. Turn on the VCR.
2. Insert a cassette with the record-protect (safety) tab intact. (Rewind if necessary).
3. Select the channel you wish to record.
4. Press the *OTR* button to select desired recording time ["0:30" (30 minutes) to "4:00" (4 hours)]

## To Stop OTR After Recording Starts

- Repeatedly press the *OTR* buttons until normal recording returns. Then press the *STOP* button during the normal recording.
- Press the *POWER* button on the VCR set.

# RECORDING(continued)

## CABLE BOX CONTROL SET UP

Cable box set up tells the VCR how to record programs from the cable box. If your cable box can be controlled by a remote, the VCR may be able to tune it to the channel you want to record during VCR Plus+ and timer recordings. Position the remote-controllable cable box on top of the VCR as shown on page 9.

|   |   |
|---|---|
| <p>1. Press PROGRAM on the remote.<br/>The program menu appears on the TV screen.</p>   | <div style="border: 1px solid black; padding: 5px; width: fit-content; margin: auto;"> <p style="text-align: center;">MAIN MENU</p> <p>1 TIMER PROGRAM<br/>2 CLOCK SET<br/>3 CHANNEL SET<br/>4 VCR FUNCTION SET UP<br/>5 LANGUAGE : → ENGLISH<br/>                                  ESPAÑOL<br/>                                  FRANÇAIS</p> <p>SELECT NUMBER<br/>PUSH PROG TO END</p> </div> |
| <p>2. Press 3 to select channel set.</p>  | <div style="border: 1px solid black; padding: 5px; width: fit-content; margin: auto;"> <p style="text-align: center;">CHANNEL SET</p> <p>1 ANT/CABLE: (CABLE BOX)<br/>2 AUTO CHANNEL PROGRAM<br/>3 CHANNEL ADD/ERASE<br/>4 VCR plus CHANNEL SET<br/>5 CABLE BOX SET UP</p> <p>SELECT NUMBER<br/>PUSH PROG FOR MAIN MENU</p> </div>  |
| <p>3. Press 5 to select CABLE BOX SET UP.<br/>Enter the cable box output channel number.</p>  | <div style="border: 1px solid black; padding: 5px; width: fit-content; margin: auto;"> <p style="text-align: center;">CABLE BOX SET UP</p> <p>CH OUT:            BRAND:<br/>                          ↑<br/>ENTER OUTPUT CHANNEL: 03<br/>(CHECK CABLE BOX SPECS)</p> <p>TURN BOX ON, TUNE TO CH 2</p> <p>USE ←→ TO CORRECT</p> </div>   |
| <p>4. Enter the Cable box brand code. (See next page)</p>   | <div style="border: 1px solid black; padding: 5px; width: fit-content; margin: auto;"> <p style="text-align: center;">CABLE BOX SET UP</p> <p>CH OUT: 03        BRAND:            ↑</p> <p>ENTER BRAND CODE: 05<br/>(CHECK OWNERS MANUAL)</p> <p>USE ← → TO CORRECT</p> </div>  |
| <p>5. The VCR will change the cable box from channel 02 to channel 09 when you enter the correct code for your cable box.<br/><b>Note:</b> After the CABLE BOX SET UP is done, ANT/CABLE mode automatically goes to CABLE BOX mode.</p> | <div style="border: 1px solid black; padding: 5px; width: fit-content; margin: auto;"> <p style="text-align: center;">CABLE BOX SET UP</p> <p>CH OUT: 03        BRAND:05</p> <p>IF CABLE BOX CHANGED TO<br/>CHANNEL 9 . . . . . PUSH PROG</p> <p>PUSH CLEAR TO EXIT</p> </div>  |



**Cable Box tuned to channel 9:** Press PROGRAM on the remote. You are finished with cable box set up. Complete "VCR Plus+ INITIAL" on the page 36-37. The VCR will then tune the cable box to the correct channel during VCR Plus+ and timer recordings.

**Cable box did not tune to channel 9:** Enter a different code from the chart. If these codes do not work:

- Try repositioning the cable box on top of the VCR and reentering the codes.
- Try entering all code numbers (00-59). Press CLEAR on remote to change incorrect entries.

If none of the codes work, press CLEAR to quit. The VCR will not control your cable box. Turn on the cable box and leave it tuned to the channel you want to record some time before the recording is to begin.

**Note:** If the picture quality is not good, change the VCR CH to another CH, then return to 3/4 CH.

| Brand                 | Code Number(s)                   | Brand     | Code Number(s)                | Brand              | Code Number(s)                |
|-----------------------|----------------------------------|-----------|-------------------------------|--------------------|-------------------------------|
| ABC                   | 53,54                            | NSC       | 09                            | Scientific Atlanta | 03,22,35                      |
| Anvision              | 07,08                            | Oak       | 01,16,38                      | Stargate Atlanta   | 58                            |
| Cablestar             | 07,08                            | Oak Sigma | 16                            | Sylvania           | 11,59                         |
| Eagle                 | 07,08                            | Panasonic | 03,27,39                      | Teknika            | 06                            |
| Eastern International | 02                               | Philips   | 07,08,19,26,28,29,32,33,40,41 | Texscan            | 10,11,59                      |
| General Instrument    | 04,05,15,23,24,25,30,36          | Pioneer   | 18,20,44                      | Tocom              | 17,21,49,50,55                |
| Hamlin                | 12,13,34,48                      | Randtek   | 07,08                         | Unika              | 31,32,41                      |
| Hitachi               | 37,43                            | RCA       | 00,27                         | Universal          | 51,52                         |
| Jerrold               | 04,05,15,23,24,25,30,36,45,46,47 | Regal     | 12,13                         | Viewstar           | 07,08,19,26,28,29,32,33,40,41 |
| Macom                 | 37,43                            | Regency   | 02,33                         | Warner Amex        | 44                            |
| Magnavox              | 07,08,19,26,28,29,32,33,40,41    | Samsung   | 44                            | Zenith             | 14,42,57                      |

# RECORDING(continued)

## Programming the Timer

The programmable clock/timer permits unattended recording of up to eight different TV programs. The timer is actually a small computer which will turn on the VCR at the time you select, record for a selected length of time, and then turn off the VCR—all automatically without you being there.

### You can program the timer to do the following:

- Record a program on a single day up to one year away (*ONE TIME PROGRAM*).
- Record a program at the same time Monday through Friday (*DAILY PROGRAM*).
- Record a program on one certain day of every week (*WEEKLY PROGRAM*).

## Simplified Programming Instructions

1. Turn on the TV and tune it to your "VCR Channel" (3,4, or video input).
2. Turn on the VCR or insert a cassette with the record-protect (safety) tab intact. (Rewind if necessary.)
3. Press the *PROGRAM* button on the remote control.
4. Watch the display on the TV screen. It will prompt you through the rest of the programming instructions.
5. **Turn off the VCR.** The VCR must be turned off for the timer program to begin.

### Things to know before you start:

- The time and date must be correct before you program the timer.
- You can program the timer up to one year before the TV program is to be recorded.
- You can correct an error in the program any time by pressing the *SHIFT* ← → button on the remote control.

| <p>[1] Press PROGRAM on the remote.<br/>The program menu appears on the TV screen.</p>  | <div style="border: 1px solid black; padding: 5px; width: fit-content; margin: auto;"> <p style="text-align: center;">MAIN MENU</p> <p>1 TIMER PROGRAM<br/>2 CLOCK SET<br/>3 CHANNEL SET<br/>4 VCR FUNCTION SET UP<br/>5 LANGUAGE : → ENGLISH<br/>                                  ESPAÑOL<br/>                                  FRANÇAIS</p> <p>SELECT NUMBER<br/>PUSH PROG TO END</p> </div>  |       |       |       |      |      |                     |  |  |   |                            |   |  |  |  |  |   |  |  |  |  |   |  |  |  |  |
|---|--|-------|-------|-------|------|------|---------------------|--|--|---|----------------------------|---|--|--|--|--|---|--|--|--|--|---|--|--|--|--|
| <p>[2] Press 1 to select the timer program.<br/>The program list from 1 to 4 appears.</p> <p>Note: You can select 1-8.<br/>If you press 5-8, the next program (5-8) list appears.</p>   | <div style="border: 1px solid black; padding: 5px; width: fit-content; margin: auto;"> <table style="width: 100%; border-collapse: collapse;"> <thead> <tr> <th style="text-align: left;">No</th> <th style="text-align: left;">CH</th> <th style="text-align: left;">START</th> <th style="text-align: left;">END</th> <th style="text-align: left;">DATE</th> </tr> </thead> <tbody> <tr><td>1</td><td></td><td></td><td></td><td></td></tr> <tr><td>2</td><td></td><td></td><td></td><td></td></tr> <tr><td>3</td><td></td><td></td><td></td><td></td></tr> <tr><td>4</td><td></td><td></td><td></td><td></td></tr> </tbody> </table> <p style="text-align: center;">SELECT 1-8, PROG TO END</p> </div> | No    | CH    | START | END  | DATE | 1                   |  |  |   |                            | 2 |  |  |  |  | 3 |  |  |  |  | 4 |  |  |  |  |
| No  | CH   | START | END   | DATE  |      |      |                     |  |  |   |                            |   |  |  |  |  |   |  |  |  |  |   |  |  |  |  |
| 1   |  |       |       |       |      |      |                     |  |  |   |                            |   |  |  |  |  |   |  |  |  |  |   |  |  |  |  |
| 2   |  |       |       |       |      |      |                     |  |  |   |                            |   |  |  |  |  |   |  |  |  |  |   |  |  |  |  |
| 3   |  |       |       |       |      |      |                     |  |  |   |                            |   |  |  |  |  |   |  |  |  |  |   |  |  |  |  |
| 4   |  |       |       |       |      |      |                     |  |  |   |                            |   |  |  |  |  |   |  |  |  |  |   |  |  |  |  |
| <p>[3] Press 1 through 8 to want to select the record timer program number.</p>   | <div style="border: 1px solid black; padding: 5px; width: fit-content; margin: auto;"> <p>PROG. 2: JAN 13 WED 11:15a</p> <table style="width: 100%; border-collapse: collapse;"> <thead> <tr> <th style="text-align: left;">CH</th> <th style="text-align: left;">START</th> <th style="text-align: left;">END</th> <th style="text-align: left;">DATE</th> </tr> </thead> <tbody> <tr> <td style="text-align: center;">↑</td> <td colspan="3">ENTER CHANNEL : ✕ —</td> </tr> </tbody> </table> <p style="text-align: center;">USE ← → TO CORRECT<br/>PUSH PROG TO END</p> </div>  | CH    | START | END   | DATE | ↑    | ENTER CHANNEL : ✕ — |  |  |   |                            |   |  |  |  |  |   |  |  |  |  |   |  |  |  |  |
| CH  | START  | END   | DATE  |       |      |      |                     |  |  |   |                            |   |  |  |  |  |   |  |  |  |  |   |  |  |  |  |
| ↑   | ENTER CHANNEL : ✕ —  |       |       |       |      |      |                     |  |  |   |                            |   |  |  |  |  |   |  |  |  |  |   |  |  |  |  |
| <p>[4] Enter Channel to want to record.</p> <p>NOTE: If you wish to record in the cable TV or cable box mode, first set the channel into the channel set mode.</p> <p>The display will prompt you to select a channel number.</p> | <div style="border: 1px solid black; padding: 5px; width: fit-content; margin: auto;"> <p>PROG. 2: JAN 13 WED 11:15a</p> <table style="width: 100%; border-collapse: collapse;"> <thead> <tr> <th style="text-align: left;">CH</th> <th style="text-align: left;">START</th> <th style="text-align: left;">END</th> <th style="text-align: left;">DATE</th> </tr> </thead> <tbody> <tr> <td style="text-align: center;">11</td> <td colspan="3"></td> </tr> <tr> <td style="text-align: center;">↑</td> <td colspan="3">ENTER START TIME ✕ - : - -</td> </tr> </tbody> </table> <p style="text-align: center;">USE ← → TO CORRECT<br/>PUSH PROG TO END</p> </div>  | CH    | START | END   | DATE | 11   |                     |  |  | ↑ | ENTER START TIME ✕ - : - - |   |  |  |  |  |   |  |  |  |  |   |  |  |  |  |
| CH  | START  | END   | DATE  |       |      |      |                     |  |  |   |                            |   |  |  |  |  |   |  |  |  |  |   |  |  |  |  |
| 11  |  |       |       |       |      |      |                     |  |  |   |                            |   |  |  |  |  |   |  |  |  |  |   |  |  |  |  |
| ↑   | ENTER START TIME ✕ - : - -   |       |       |       |      |      |                     |  |  |   |                            |   |  |  |  |  |   |  |  |  |  |   |  |  |  |  |

# RECORDING(continued)

| <p>[5] Enter start time.<br/> <b>Note:</b> Always press "0" before single digit hours, minutes, months, or days.</p>   | <div style="border: 1px solid black; padding: 5px;"> <p>PROG 2:JAN 13 WED 11:15</p> <table border="1"> <thead> <tr> <th>CH</th> <th>START</th> <th>END</th> <th>DATE</th> </tr> </thead> <tbody> <tr> <td>11</td> <td>7:00</td> <td></td> <td></td> </tr> </tbody> </table> <p style="text-align: center;">↑</p> <p>SELECT 1=AM, 2=PM</p> <p>USE ← → TO CORRECT<br/>           PUSH PROG TO END</p> </div>   | CH   | START    | END | DATE | 11 | 7:00  |      |          |
|--|--|------|----------|-----|------|----|-------|------|----------|
| CH   | START  | END  | DATE     |     |      |    |       |      |          |
| 11   | 7:00   |      |          |     |      |    |       |      |          |
| <p>[6] Press 1 to select AM or 2 to select PM.<br/> <b>Note:</b> Noon is 12 PM<br/>           Midnight is 12 AM</p>  | <div style="border: 1px solid black; padding: 5px;"> <p>PROG 2:JAN 13 WED 11:15</p> <table border="1"> <thead> <tr> <th>CH</th> <th>START</th> <th>END</th> <th>DATE</th> </tr> </thead> <tbody> <tr> <td>11</td> <td>7:00a</td> <td></td> <td></td> </tr> </tbody> </table> <p style="text-align: center;">↑</p> <p>ENTER END TIME <del>---</del> : --</p> <p>USE ← → TO CORRECT<br/>           PUSH PROG TO END</p> </div>   | CH   | START    | END | DATE | 11 | 7:00a |      |          |
| CH   | START  | END  | DATE     |     |      |    |       |      |          |
| 11   | 7:00a  |      |          |     |      |    |       |      |          |
| <p>[7] Enter end time.<br/>           AM or PM is automatically displayed after you enter the END TIME.</p>  | <div style="border: 1px solid black; padding: 5px;"> <p>PROG 2:JAN 13 WED 11:15</p> <table border="1"> <thead> <tr> <th>CH</th> <th>START</th> <th>END</th> <th>DATE</th> </tr> </thead> <tbody> <tr> <td>11</td> <td>7:00a</td> <td>8:30</td> <td>JAN14 93</td> </tr> </tbody> </table> <p style="text-align: center;">↑</p> <p>ENTER DATE : <del>---</del> / <del>---</del> / <del>---</del> AUTO<br/>           (DAILY/WEEKLY : PUSH 00)</p> <p>USE ← → TO CORRECT<br/>           PUSH PROG TO END</p> </div> | CH   | START    | END | DATE | 11 | 7:00a | 8:30 | JAN14 93 |
| CH   | START  | END  | DATE     |     |      |    |       |      |          |
| 11   | 7:00a  | 8:30 | JAN14 93 |     |      |    |       |      |          |
| <p>[8] Enter date.<br/> <b>Note:</b> Always press "0" before a single digit month or day.<br/>           If you wish to select the daily/weekly programming, Press 00, then daily/weekly programming menu appears.</p>   | <div style="border: 1px solid black; padding: 5px;"> <p>1 EVERY SUNDAY<br/>           2 EVERY MONDAY<br/>           3 EVERY TUESDAY<br/>           4 EVERY WEDNESDAY<br/>           5 EVERY THURSDAY<br/>           6 EVERY FRIDAY<br/>           7 EVERY SATURDAY<br/>           8 MONDAY TO FRIDAY</p> <p>SELECT NUMBER</p> </div>   |      |          |     |      |    |       |      |          |
| <p>[9] Select 4 if you want to record every wednesday.</p>   | <div style="border: 1px solid black; padding: 5px;"> <p>PROG 2:JAN 13 WED 11:15</p> <table border="1"> <thead> <tr> <th>CH</th> <th>START</th> <th>END</th> <th>DATE</th> </tr> </thead> <tbody> <tr> <td>11</td> <td>7:00a</td> <td>8:30</td> <td>WED'S</td> </tr> </tbody> </table> <p style="text-align: center;">↑</p> <p>SELECT TAPE SPEED : AUTO</p> <p>USE ← → TO CORRECT<br/>           PUSH PROG TO END</p> </div>  | CH   | START    | END | DATE | 11 | 7:00a | 8:30 | WED'S    |
| CH   | START  | END  | DATE     |     |      |    |       |      |          |
| 11   | 7:00a  | 8:30 | WED'S    |     |      |    |       |      |          |
| <p>[10] Press the SP/SLP button to select the tape speed. If the tape length may not be long enough for timer recording in the SP mode, set the recording speed to AUTO at this step. Recording starts in the SP mode and the VCR automatically selects the tape speed to record the program to the end. If the tape length is not long enough, the tape speed automatically changes from the SP mode to the SLP mode. The Power Off Message appears on the TV screen.</p> | <div style="border: 1px solid black; padding: 5px;"> <p>REMEBER TO CHECK TAPE<br/>           AND TURN VCR POWER OFF<br/>           FOR TIMER RECORDING</p> </div>  |      |          |     |      |    |       |      |          |

# RECORDING (VCR Plus+)

## Tuesday

5:30PM  
7PM

**NICK** MAKE THE GRADE—Game 751075  
**SN** HORSE RACING WRAP-UP 203094  
**MT** BUGS BUNNY AND PAL; 90 min. 777926  
 5:35 **WB** WHO'S THE BOSS? (CC) 201836  
**TS** ANDY GRIFFITH—Comedy BW 7824146

### EVENING

6 PM **2** CBS NEWS (CC)—Dan Rathef 29  
**3** NEWS 7181/19549  
**9** CHEERS (cc)—Comedy 5933  
 Sam's regulars are reluctant to hang out at a bar that's promising to become a gay hangout. Ted Danson, Shelley Long, Tom: Alan Autry.  
**11** MacNEIL, LEHRER; 60 min. 64094  
**20** WOODWRIGHT'S SHOP 98467  
**28** AMANDA SABATER; 60 min. 86810  
**29** FAMILY TIES (CC)—Comedy 52758  
 Fearing the worst as Steven undergoes heart surgery, Elyse confides her deepest concerns to Alex. Part 2 of three. Young Steven: Michael David Wright.  
**38** HEALTH—Discussion 655  
**41** PASIONARIA—Novela; 60 min. 46549  
**50** GIMME A BREAK!—Comedy 112079  
 Nell (Nell Carter) decides that Carl (Dolph Sweet) has been a widower long enough.  
**59** INDIANA NIGHTLY REPORT; 60 min. 82536  
**65** HIGHWAY TO HEAVEN (CC)—Drama; 60 min. 77487  
 Jonathan (Michael Landon) must find a mate

**60** HEAD OF THE CLASS (CC) 111029  
 Darlene and Alan (Robin Givens, Tony O'Dell) find particular surprises when the students research their roots for an essay assignment. Howard Hesseman, Brian Robbins.  
**83** BATTLELINE—Documentary BW 769094  
**AMC** MOVIE—Drama; 1hr., 50 min. 4535520  
 "Heaven Knows, Mr. Allison." (1957) John Huston's shrewd character study of a marine and a nun (Robert Mitchum, Deborah Kerr) trying to survive on a Japanese-held island.  
**85** LIVE FROM L.A.—Interview 299891  
**87** CROSSFIRE—Buchanan/Kinsley 754297  
**89** WORLD MONITOR—John Hart 774926  
**92** EDWARD SCISSORHANDS 121810  
 Director Time Burton with a behind-the-scenes look at his latest movie.  
**100** HOT SEAT 378433  
**NK** LOONEY TUNES—Cartoon 772568  
**SN** GARRY SHANDLING (CC) 756655  
**USA** NUTCRACKER SCOOB—Cartoon 749365  
 Scooby Doo and the gang's visit to a children's home leads them on a search for a hidden emerald that's also being sought after by the evil Mr. Nicklby and a ghost.  
 6:35 **WB** WHO'S THE BOSS? (CC) 395029  
**TS** BLUE TOES, THE CHRISTMAS ELF—Cartoon 25413097  
 Santa's smallest elf earns the right to ride in Santa's sleigh at Christmas.  
**TS** JEFFERSONS (CC)—Comedy 993013  
 7 PM **2** RESCUE 911 (CC); 60 min. 4297

\* VCR Plus+ and PlusCode are trademarks of Gemstar Development Corporation. VCR Plus+ system is manufactured under license from Gemstar Development Corporation.

† Scrambled channels with decoder box require additional steps to record. Refer to the set-up and programming instructions.

Sample page from TV Guide showing Plus Codes

After initial set up, the new VCR Plus+\* programming feature lets you program the VCR for unattended recordings by entering a PlusCode\* number. The plusCodes are published in the TV listings of many newspapers, TV Guide, and local cable-TV guides. These PlusCode numbers provide your VCR with all the information it needs to make an unattended recording, so you do not have to program start time, stop time, channel number, or date†. These code numbers can vary from one to eight digits and are usually listed with the program name as shown here in the sample page of a TV Guide listing.

Depending on how your VCR is connected, you may need to enter the channel numbers for your area which match the VCR Plus+ guide channel numbers.

**Before attempting to use the VCR Plus+ feature, read the initial set-up instructions for your type of connection.**

VCR Plus+ set up is a procedure that tells your VCR what channel to record when you select a PlusCode number. VCR Plus+ guide channel numbers are especially important when the VCR is connected to a cable-TV system. Guide channel numbers for some of the cable services such as HBO, The Disney Channel, and ESPN have been standardized for all locations where PlusCodes are available. Certain channels received on a home antenna may also require set up. The VCR Plus+ guide channel charts for both cable-TV and broadcast channels are usually located in the TV program listings in your TV Guide or local TV publication. Your VCR makes channel set up easy. Instructions begin on the next page.

**Note:** If the PlusCodes are not currently available in your area, they will probably be introduced soon. Check with your local newspaper or cable-TV company for publishing details.

To enable people across the country to all use the PlusCode numbers, each broadcast station and cable-TV channel have been assigned a special VCR Plus+ guide channel number.

Channel Line-up Chart from Cable-TV Company

| VCR+ CHANNEL NUMBERS                      |                   |                 |
|---|-------------------|-----------------|
| Following are the VCR+ assigned channels: |                   |                 |
| Broadcast Channels                        | Assigned Channels | BRAV.....54     |
|   |                   | CMTV.....14     |
|   |                   | CNN.....42      |
| 3 KVRA(NBC).....3                         |                   | CHANN-HN.....16 |
| 6 KVIE(PBS).....6                         |                   | COMMUNITY.....3 |
| 10 KXTV(CBS).....10                       |                   | C-SPAN1.....6   |
| Example                                   |                   |                 |
| 36 KICU(IND).....36                       | SCBA.....89       |                 |
| 5 KPIX(CBS).....8                         | TBS.....25        |                 |
| 9 KRCR(ABC).....9                         | TDC.....23        |                 |
| 7 KRCR(ABC).....5                         | TELE.....55       |                 |
| 9 KIXE(PBS).....4                         | TMC.....89        |                 |
| 26 KTSF(IND).....26                       | TNN.....49        |                 |
| 2 KTVN(CBS).....22                        | TNT.....42        |                 |
| 65 Sacramento.....65                      | USA.....44        |                 |
| Cable.....Assigned Channels.....Channels  | WH-1.....62       |                 |
| A & E.....39                              | WEAT.....22       |                 |
| AMC.....35                                | WGN.....56        |                 |
|   | WWOR.....35       |                 |

VCR Plus+ Guide Channel Chart from Local TV Listing

| JONES INTERCABLE  |   |
|---|---|
| CHANNEL KINE-UP-Camel (Effective February 1990)                             |   |
| Channel 2.....  | ME/   |
| Channel 3.....  | 8 WISH  |
| Channel 4.....  | Indianapolis-CBS  |
| Channel 5.....  | A.P. News Plus<br>News/Sports/Business in formation                           |
| Channel 6.....  | 9 WGN   |
| Channel 7.....  | Chicago-Independent<br>VCA/Local Origination<br>Video Classified Advertising  |
| Channel 8.....  | HOME BOX OFFICE<br>Premium Service  |
| Channel 9.....  | 17 WTBS<br>Atlanta-Independent<br>CNN Headline<br>Cable News Headline Service |
| Example   |   |
| Channel 30.....   | VH-1  |
| Channel 31.....   | Video Hit ONE<br>20 WFYI  |
| Channel 32.....   | Indianapolis-PBS  |
| Channel 33.....   | Lifetime<br>TNT   |
| Channel 34.....   | Turner Network Television<br>ESPN   |
| Channel 35.....   | 24-Hour Sports Network<br>HSC   |
| Channel 36.....   | Home Shopping Club<br>Weather Radar<br>24-Hour Local Color Radar              |
| Channel 37.....   | BRAVO<br>Fine Arts/Culture  |
| Jones Intercable Inc.<br>515 E. Carmel Drive • Carmel, IN 46032<br>344-5877 |   |

# RECORDING (VCR Plus+)

## VCR PLUS+ INITIAL

### when using a antenna

VCR connected as shown on page 7-8.

|   |   |
|---|---|
| <p>1. Press PROGRAM on the remote.<br/>The program menu appears on the TV screen.</p>   | <div style="border: 1px solid black; padding: 5px; text-align: center;"> <p>MAIN MENU</p> <p>1 TIMER PROGRAM<br/>2 CLOCK SET<br/>3 CHANNEL SET<br/>4 VCR FUNCTION SET UP<br/>5 LANGUAGE : → ENGLISH<br/>                          ESPAÑOL<br/>                          FRANÇAIS</p> <p>SELECT NUMBER<br/>PUSH PROG TO END</p> </div> |
| <p>2. Press 3 to select channel set.</p>  | <div style="border: 1px solid black; padding: 5px; text-align: center;"> <p>CHANNEL SET</p> <p>1 ANT/CABLE: (ANTENNA)<br/>2 AUTO CHANNEL PROGRAM<br/>3 CHANNEL ADD/ERASE<br/>4 VCR plus CHANNEL SET<br/>5 CABLE BOX SET UP</p> <p>SELECT NUMBER<br/>PUSH PROG FOR MAIN MENU</p> </div>  |
| <p>3. Select ANTENNA in the ANT/CABLE mode.</p>   | <div style="border: 1px solid black; padding: 5px; text-align: center;"> <p>CHANNEL SET</p> <p>1 ANT/CABLE: (ANTENNA)<br/>2 AUTO CHANNEL PROGRAM<br/>3 CHANNEL ADD/ERASE<br/>4 VCR plus CHANNEL SET<br/>5 CABLE BOX SET UP</p> <p>SELECT NUMBER<br/>PUSH PROG FOR MAIN MENU</p> </div>  |
| <p>4. Press 4 to select VCR plus CHANNEL SET.</p>   | <div style="border: 1px solid black; padding: 5px; text-align: center;"> <p>..... VCR+ CHANNEL: .....</p> <p>2 3 4 5 6 7</p> <p>↓</p> <p>2 3 4 5 6 7</p> <p>... ANT. CHANNEL ...</p> <p>ENTER ANT. CHANNEL:  </p> <p>USE ←→ TO SHIFT<br/>PUSH PROG TO END</p> </div>  |
| <p>5. Enter the ANT. Channel number by using number buttons and shift buttons.</p> <p><b>Note:</b> Enter two numbers to enter each channel number you receive on a different channel than the assigned VCR Plus+ channel number.</p> <p>If a channel in your area has been assigned more than one VCR Plus+ channel number, enter that same channel number under each VCR Plus+ channel number.</p> | <div style="border: 1px solid black; padding: 5px; text-align: center;"> <p>..... VCR+ CHANNEL: .....</p> <p>69 3 4 5 6 7</p> <p>↓</p> <p>8 3 4 5 6 7</p> <p>... ANT. CHANNEL ...</p> <p>ENTER ANT. CHANNEL: 08</p> <p>USE ←→ TO SHIFT<br/>PUSH PROG TO END</p> </div>  |

# RECORDING (VCR Plus+)

## when using a cable or cable box.

VCR connected as shown on page 9-10.

|   |   |
|---|---|
| <p>1. Press on the remote.<br/>The program menu appears on the TV screen.</p>   | <div style="border: 1px solid black; padding: 5px; width: fit-content; margin: auto;"> <p style="text-align: center;">MAIN MENU</p> <p>1 TIMER PROGRAM<br/>2 CLOCK SET<br/>3 CHANNEL SET<br/>4 VCR FUNCTION SET UP<br/>5 LANGUAGE : → ENGLISH<br/>                                  ESPAÑOL<br/>                                  FRANÇAIS</p> <p>SELECT NUMBER<br/>PUSH PROG TO END</p> </div>   |
| <p>2. Press 3 to select CHANNEL SET.</p>  | <div style="border: 1px solid black; padding: 5px; width: fit-content; margin: auto;"> <p style="text-align: center;">CHANNEL SET</p> <p>1 ANT/CABLE: (ANTENNA)<br/>2 AUTO CHANNEL PROGRAM<br/>3 CHANNEL ADD/ERASE<br/>4 VCR plus CHANNEL SET<br/>5 CABLE BOX SET UP</p> <p>SELECT NUMBER<br/>PUSH PROG FOR MAIN MENU</p> </div>  |
| <p>3. Press 1 to select CABLE-TV.</p>   | <div style="border: 1px solid black; padding: 5px; width: fit-content; margin: auto;"> <p style="text-align: center;">CHANNEL SET</p> <p>1 ANT/CABLE: (CABLE TV)<br/>2 AUTO CHANNEL PROGRAM<br/>3 CHANNEL ADD/ERASE<br/>4 VCR plus CHANNEL SET<br/>5 CABLE BOX SET UP</p> <p>SELECT NUMBER<br/>PUSH PROG FOR MAIN MENU</p> </div>   |
| <p>4. Press 4 to select VCR plus CHANNEL SET.</p>   | <div style="border: 1px solid black; padding: 5px; width: fit-content; margin: auto;"> <p style="text-align: center;">..... VCR+ CHANNEL: .....</p> <p style="text-align: center;">1 2 3 4 5 6</p> <p style="text-align: center;">↓</p> <p style="text-align: center;">1 2 3 4 5 6</p> <p style="text-align: center;">..... CABLE CHANNEL: .....</p> <p>ENTER CABLE CHANNEL: <input type="text" value="08"/></p> <p>USE ←→ TO SHIFT<br/>PUSH PROG TO END</p> </div> |
| <p>5. Enter the VCR+ Channel number by using number buttons and shift buttons.<br/><b>Note:</b> Enter two numbers to enter each channel number you receive on a different channel than the assigned VCR Plus+ channel number.<br/>If a channel in your area has been assigned more than one VCR Plus+ channel number, enter that same channel number under each VCR Plus+ channel number.</p> | <div style="border: 1px solid black; padding: 5px; width: fit-content; margin: auto;"> <p style="text-align: center;">..... VCR+ CHANNEL: .....</p> <p style="text-align: center;">125 1 2 3 4 5</p> <p style="text-align: center;">↓</p> <p style="text-align: center;">8 1 2 3 4 5</p> <p style="text-align: center;">..... CABLE CHANNEL: .....</p> <p>ENTER CABLE CHANNEL: 08</p> <p>USE ←→ TO SHIFT<br/>PUSH PROG TO END</p> </div>                            |

# RECORDING (VCR Plus+)

## Setting a VCR Plus+ Recording

The VCR Plus+ and timer program features let you program the VCR to record up to eight different programs within a one year period. Before using VCR Plus+ to record a program, make sure that:

- Cable box set up has been completed, if necessary.
- VCR Plus+ set up has been completed.
- The clock is set correctly.
- A tape with safety tab has been inserted with enough tape to record the programs.

| <p>1. Press VCR+ on the remote .<br/>The VCR plus PROGRAM appears.</p>   | <div data-bbox="1005 491 1334 730" style="border: 1px solid black; padding: 10px; text-align: center;"><p>VCR plus PROGRAM</p><p>↑</p><p>ENTER VCR plus CODE</p><p>USE ← → TO CORRECT<br/>PUSH VCR+ WHEN DONE</p></div>  |      |          |     |      |      |       |      |          |
|--|--|------|----------|-----|------|------|-------|------|----------|
| <p>2. Enter VCR plus code.<br/>If it is not correct, use shift button to correct.</p>  | <div data-bbox="1005 793 1334 1033" style="border: 1px solid black; padding: 10px; text-align: center;"><p>VCR plus PROGRAM</p><p>73978</p><p>↑</p><p>ENTER VCR plus CODE</p><p>USE ← → TO CORRECT<br/>PUSH VCR+ WHEN DONE</p></div>   |      |          |     |      |      |       |      |          |
| <p>3. Press VCR+ when done.</p>  | <div data-bbox="1005 1096 1334 1335" style="border: 1px solid black; padding: 10px;"><p>VCR+1 : NOV 11 FRI 11:32a</p><table border="1" style="width: 100%; border-collapse: collapse;"><thead><tr><th>CH</th><th>START</th><th>END</th><th>DATE</th></tr></thead><tbody><tr><td>11c</td><td>6:35a</td><td>8:11</td><td>NOV11 11</td></tr></tbody></table><p style="text-align: right;">AUTO</p><p>1 ONE TIME<br/>2 DAILY (MON → FRI)<br/>3 WEEKLY (FRI)<br/>SELECT NUMBER<br/>PUSH VCR+ TO END</p></div> | CH   | START    | END | DATE | 11c  | 6:35a | 8:11 | NOV11 11 |
| CH   | START  | END  | DATE     |     |      |      |       |      |          |
| 11c  | 6:35a  | 8:11 | NOV11 11 |     |      |      |       |      |          |
| <p>4. Select 1-3.<br/>(See page 33.)</p>   | <div data-bbox="1005 1398 1334 1638" style="border: 1px solid black; padding: 10px;"><p>VCR+1 : NOV 11 FRI 11:32a</p><table border="1" style="width: 100%; border-collapse: collapse;"><thead><tr><th>CH</th><th>START</th><th>END</th><th>DATE</th></tr></thead><tbody><tr><td>116c</td><td>6:00a</td><td>8:00</td><td>NOV11 11</td></tr></tbody></table><p style="text-align: right;">AUTO</p><p>SELECT TAPE SPEED: ↑</p><p>PUSH VCR+ TO END</p></div>   | CH   | START    | END | DATE | 116c | 6:00a | 8:00 | NOV11 11 |
| CH   | START  | END  | DATE     |     |      |      |       |      |          |
| 116c   | 6:00a  | 8:00 | NOV11 11 |     |      |      |       |      |          |
| <p>5. Select tape speed.<br/>Press VCR+ to end.</p> <p><b>Note:</b> If using a cable box the VCR can control, turn on the cable box before the time the recording is to begin.<br/>If using a cable box the VCR cannot control, turn on the cable box and tune it to the channel you want to record before the time recording is to begin.</p> | <div data-bbox="1005 1696 1334 1936" style="border: 1px solid black; padding: 10px; text-align: center;"><p>REMEMBER TO CHECK TAPE<br/>AND TURN VCR POWER OFF<br/>FOR TIMER RECORDING</p></div>  |      |          |     |      |      |       |      |          |

# RECORDING(continued)

---

## Checking Timer Programs (Include VCR Plus+)

Programs can be checked whenever the VCR is turned on.

1. Press the PROGRAM button on the remote control to display the program menu.
2. Press number button "1" for TIMER PROGRAM. The TV screen will display the information you entered for the 1-4 program for a few seconds.
3. Press 5-8 button if you want to view the next program information.

## Timer Recording From the VCR's Line Input (AUDIO and VIDEO IN Jacks)

It is also possible to timer record from a device connected to the VCR's AUDIO and VIDEO IN jacks (called "line input"). To enter the channel for the timer recording, press INPUT SELECT button. The "L1 (L2)" indicator appears in the VCR's display panel, and LINE1(2) appears instead of the channel number on the TV screen. This is convenient if you have a satellite receiver or similar device attached to the AUDIO and VIDEO IN jacks on the VCR.

## Clearing a Timer Program (VCR Plus+)

1. Press the PROGRAM button on the remote control to display the program menu.
2. Press number button "1" select TIMER PROGRAM. The TV screen will display the information you entered for the 1-4 program for a few seconds.
3. Press 5-8 button if you want to view the next program information.
4. Press the number button on the remote control to clear the program you want to clear.
5. Press the CLEAR (program) button to remove the program from the TV screen.
6. Press the PROGRAM button to remove the program menu from the TV screen.

## Stopping a Timer Recording in Progress

Press the POWER button on the VCR to stop a Timer Recording in Progress.

---

**Notes:** ONE TIME PROGRAMS clear automatically when the recording is finished.

Daily and weekly programs remain in the timer indefinitely.

All programs are erased if power is interrupted for an extended period. (about one minute)

---

## Notes:

- Set the tape speed according to the tape remaining time.
  - When the remaining tape amount is small compared with the reserved recording time and the timer recording starts in the SLP mode from the beginning, the recording is not completed to the end.
  - The picture will be distorted when playing back the part where the recording mode was switched over from the SP mode to SLP mode with the AUTO tape speed recording method.
-



# RECORDING(continued)

## Timer Recording

The information on this page tells you how to set up your VCR for timer recording after you have programmed the timer. *The programming instructions for time programming are on pages 31-39.*

When you have finished programming the timer, follow the steps in the drawing to prepare the VCR for timer recording. We suggest that you make one or more short timer recordings for practice.

If you have a daily or weekly program in the VCR's timer, check the steps in the drawing sometime before the recording time to be sure that your VCR is ready to record.

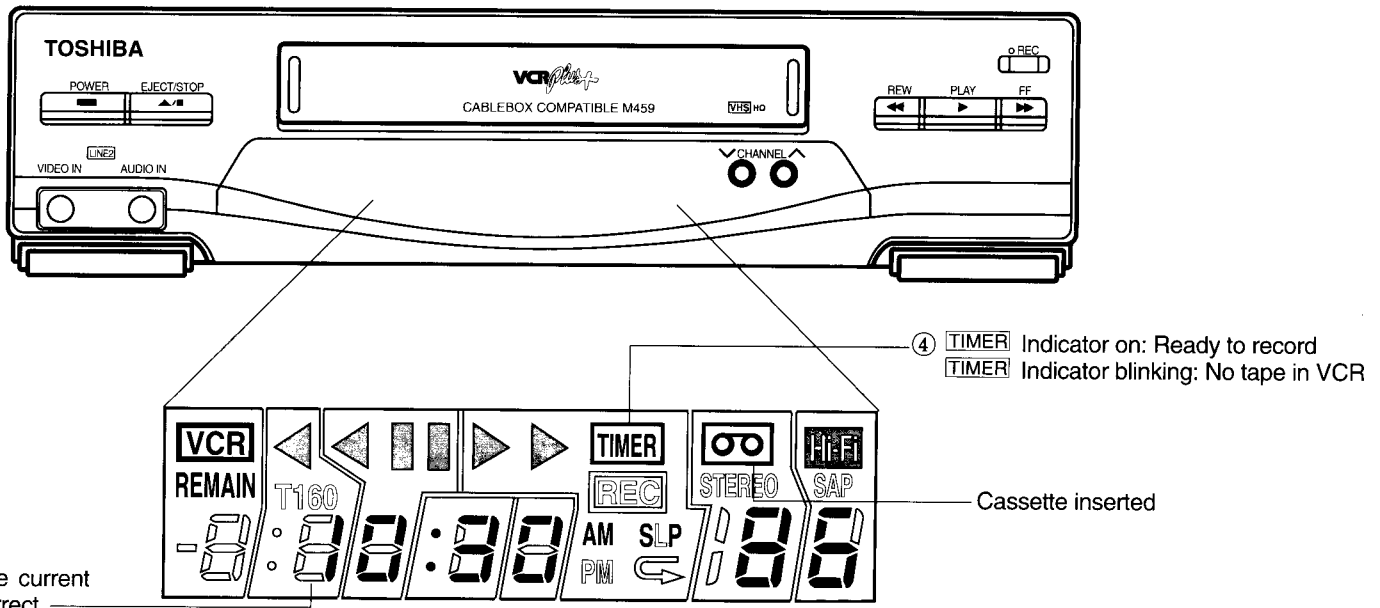

Make sure current time is correct

- 1 Program the time. See page 14.
- 2 Insert a cassette with the record-protect(safety) tab intact. (Rewind if necessary.)
- 3 **TURN OFF VCR.** The VCR must be off to activate the timer.
- 4 Check VCR's display panel.

### Timer Recording Checklist

The checklist below is provided for your use when making time recordings on the VCR.

- Cassette inserted in the VCR.
- Cassette has its record-protect(safety) tab in place. If not, the cassette is ejected. See "Erase Protection" on page 24.
- Cassette length and recording speed are adequate for program(s) to be recorded.
- Cassette rewound to beginning or to desired place on tape.
- Clock set to correct time and date.
- Timer has been programmed as described on pages 33-34, 39.
- VCR has been turned off. The **TIMER** indicator appears only if the timer is programmed and the VCR is turned off.

### Stopping a Timer Recording in Progress

Press the **POWER** button on the VCR to stop a Timer Recording in Progress.

### Timer and OTR Recording

The timer cannot begin recording if the VCR is already recording with OTR. You can OTR along with timer recording, but be careful that the programming times of the OTR and timer recordings do not overlap. If this should happen, the function to be selected in advance will take priority.

### TV Viewing During a Timer Recording

When the VCR turns on automatically to make a timer recording, it does not disturb whatever program you may be watching at the time. If you want to monitor the recording, press the **TV/VCR** button to turn on the **VCR** indicator and tune your TV to the "VCR Channel" (3, 4 or video input).

# RECORDING(continued)

## Recording From a Camcorder

To duplicate tapes using your camcorder, connect your camcorder to the VCR as shown below. You will need an output cable(usually supplied with the camcorder).

- ① Connect the *VIDEO* plug from the output cable to the *VIDEO IN* jack on the front or the rear of the VCR.
- ② Connect the *AUDIO* plug from the output cable to the *AUDIO IN* jack on the front or the rear of the VCR.
- ③ Connect the other end of the output cable to the *AUDIO/VIDEO OUT* connector on the camcorder.

**Caution:** The unauthorized recording of television programs and other material may infringe the rights of others.

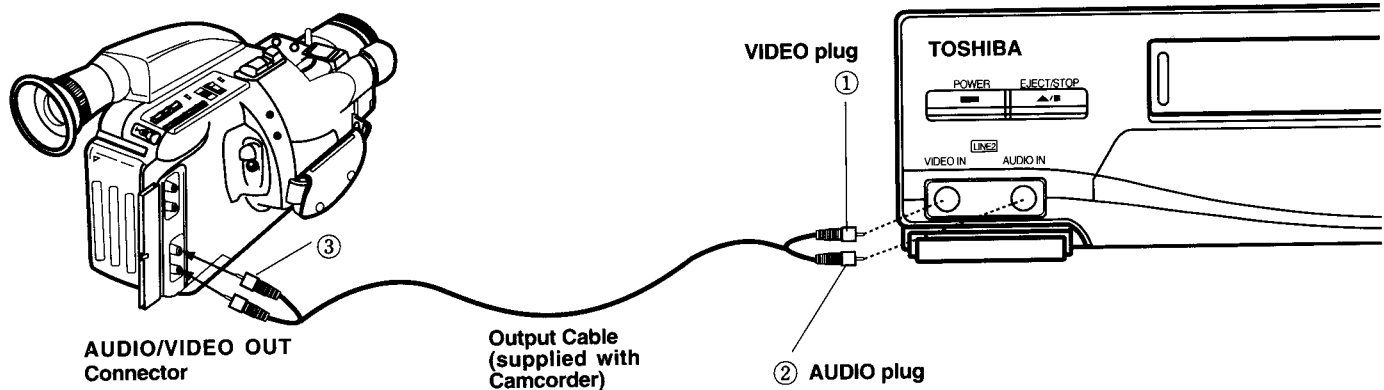

### VHS CAMCORDER

## Simplified Operating Instructions

1. Connect the camcorder to the VCR as shown above.
2. Turn on the TV and tune it to the "VCR Channel" (3, 4, or video input.)
3. Turn on the camcorder and VCR.
4. Insert the recorded cassette that you want to duplicate in the camcorder.
5. Insert a blank cassette with its record-protect(safety) tab intact into the VCR.
6. Make sure the **VCR** indicator appears in the VCR's display panel. If not, press the *TV/VCR* button to turn it on.
7. Make sure the "L2" indicator appears in the VCR's display panel. If not, press the *INPUT SELECT* button to turn it on.
8. Select the tape recording speed (*SP* or *SLP*) by pressing the *SP/SLP* button.
9. Rewind the cassettes if necessary.
10. Press the *REC* button on the VCR or on the Remote Control.
11. Place the camcorder in the playback mode and press the *PLAY* button.
12. Adjust the *TRACKING* control on the camcorder, if necessary.

**Note:** If the cassette tracking was not adjusted correctly on the camcorder, horizontal streaks may appear in the picture. Adjust the camcorder's tracking.

13. If you want to edit out any of the material, press the *PAUSE* button on the VCR's remote control. Press the *PAUSE* button again to resume recording.

**Note:** Use *PAUSE* only for pauses less than three or four minutes. Press the *EJECT/STOP* button on the VCR (or the *STOP* button on the VCR's remote control) for longer pauses. Press the *REC* button on the VCR to resume recording.

14. Stop the camcorder and VCR when you are finished.

**Note:** The TV does not have to be on to copy tapes. If you want to watch another TV channel, press the *TV/VCR* button to turn off the **VCR** indicator. Then select the channel you want to watch with the TV's channel buttons.

**Remember:** Turn off the "L2" indicator for normal recording from the VCR's tuner.

# RECORDING(continued)

## Recording From Another VCR

To copy your home videos from one VCR to another, use one VCR as the playback VCR and another VCR as the recording VCR.

### Connecting the VCR's

1. Connect a shielded Audio/Video cable from the *VIDEO OUT* jack on the playback VCR to the *VIDEO IN* jack on the recording VCR.
2. Connect another cable from the *AUDIO OUT* jack on the playback VCR to the *AUDIO IN* jack on the recording VCR.

**Important Note:** Be sure that the recording VCR is connected to the TV so that you can see what is being recorded. This can be done either by connecting the *VIDEO* and *AUDIO OUT* jacks of the recording VCR to the *VIDEO* and *AUDIO IN* jacks of the TV or by connecting the *OUT TO TV* jack on the recording VCR to the *VHF IN* jack on the TV.

**Caution:** The unauthorized recording of television programs and other material may infringe the rights of others.

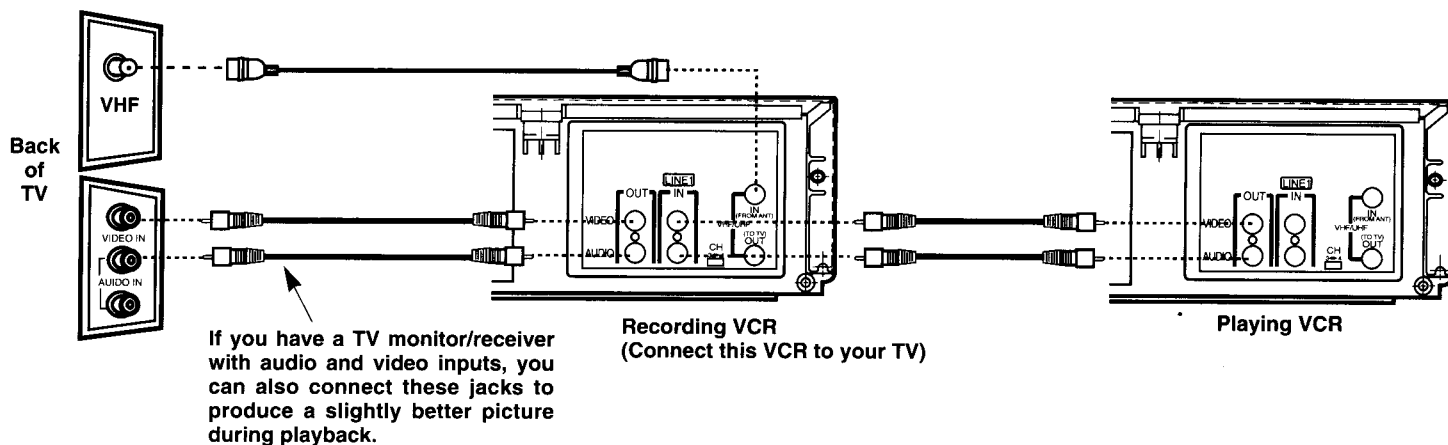

## Copying Your Home Video

1. Turn on the TV and VCR's. Tune the TV to the "VCR Channel" (3,4 or video input).

**Note:** If you are using channel 3 or 4 on your TV to watch the VCR, be sure the **VCR** indicator in the recording VCR's panel is on. Press the **TV/VCR** button to turn it on.

2. Press the **INPUT SELECT** button to turn on the "L1" indicator in the recording VCR's display panel.
3. Insert the home video that you want to copy into the playback VCR. Insert a blank tape into the recording VCR.
4. Press the **PLAY** button on the playback VCR to play the tape. Press the **PAUSE** button on the playback VCR when you reach the point where you want to begin copying.

**Note:** If the tape tracking was not adjusted properly on the playback VCR, horizontal streaks may appear in the picture. You may need to adjust the tracking on the playback VCR with the **TRACKING** up and down buttons on the remote control.

5. Press the **REC** button on the recording VCR, and then press the **PAUSE** button to place the recording VCR in the record pause mode.
6. Press the **PAUSE** buttons on **both VCR's at the same time** to begin copying the tape.

**Note:** You can edit out segments that you do not want to copy by pressing the **PAUSE** button on the recording VCR at any time to stop copying the tape. Locate the next segment you want to copy on the playback VCR by using the **FF**, **REW**, and **PLAY** buttons. Then place the playback VCR in the play-pause mode by pressing its **PAUSE** button. Press the **PAUSE** buttons **at the same time on both VCR's** to resume copying.

There are some other brand VCR sets which it works in the world. (**PAUSE** button)

7. Press the **STOP** buttons on both VCR's when you are finished.

**Note:** Remember to turn off the "L1" indicator in the VCR's display panel for normal recording from the VCR's tuner.

**Caution:** Avoid pausing for more than three or four minutes because the spinning heads that do the recording are still in contact with the tape and will eventually wear off the active material. This can cause streaks or spots in the picture when you play the worn part of the tape (called dropouts). To help prevent excessive tape wear, the VCR will automatically switch from pause to stop after about five minutes.

# SPECIALIZED OPERATIONS

## Index

You can easily search for the recorded program using the index signal registered together with it on the tape.

### • Scan and Play Index Playback

This function plays back the tape around where the index signal is registered for about 6 seconds while fast forwarding or rewinding. (This function is operable using the remote control.)

## Index Register

There are two ways to register INDEX signals: automatically and manually.

### • Auto Register

Press the recording button during the stop mode and the index signals are registered automatically. Auto register can be operated during one touch timer(OTR) or timer programming recording.

### • Manual Register(using the remote control)

During recording, index signals can be registered at the desired sections of the tape by pressing the INDEX button on the remote control.

## Notes:

- When registering or erasing the index signals is operated on the tape recorded on other VCRs, its pictures may be distorted.
- When you start index playback at the beginning or at the end of the tape, the first index mark on the tape might be skipped by the VCR.
- When registering index signals at 2 or more sections on the tape, certain intervals should be needed: more than 1 min. in SP mode and more than 3 min. in SLP mode.
- Index signal may not find the correct position in accordance with the tape condition.

## Scan and Play(Index Playback)

(Remote Control)

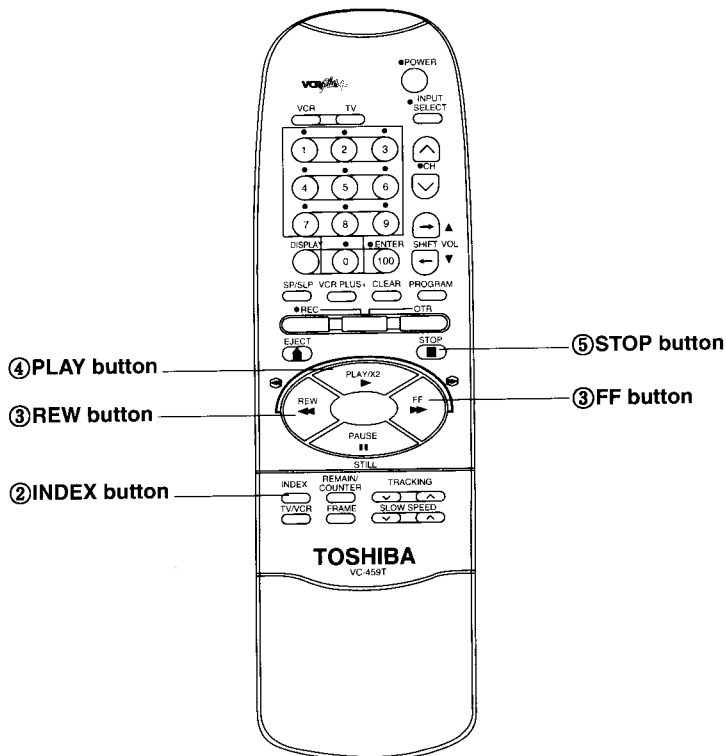

① Load the tape with index signals, then play back or stop it depending on preference.

② Press the INDEX button.

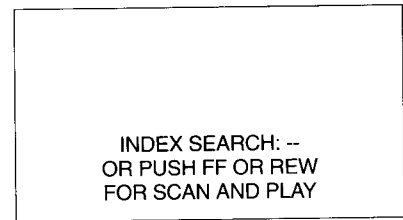

③ Press either the FF button or REW button within 9 seconds.  
• Press FF if you are at the beginning of the tape.  
• Press REW if you are at the end of the tape.

The VCR starts to fast forward or rewind the tape, playing it back around the section where the index signal is registered for 6 seconds. This operation is repeated until the end of the tape is reached.

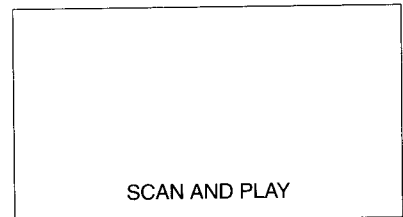

④ Press the PLAY button when the desired program is searched. "SCAN AND PLAY" on the screen goes off.

If the button is not pressed, fast forwarding or rewinding resumes while the next index signal is being searched.

⑤ Press the STOP button to stop playback.

# SPECIALIZED OPERATIONS(continued)

## Skip Search 1 (Index Playback)

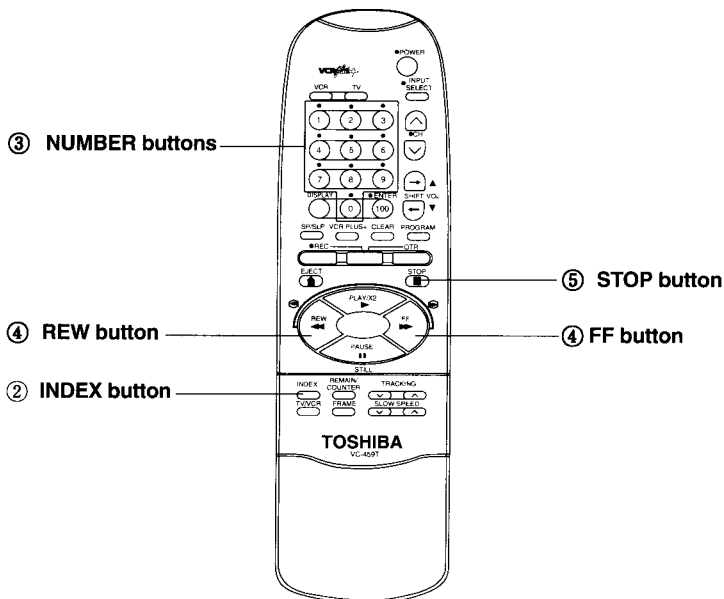

- ③ Press the *NUMBER* buttons to specify the index signal within 9 seconds. The index signal number is displayed on the screen.

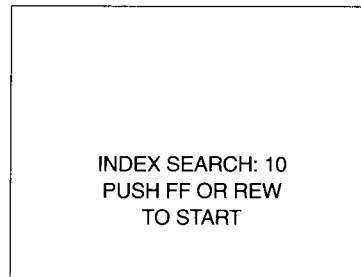

- ④ Within 9 seconds, press the *FF* button, if the desired index signal is in the program ahead, or the *REW* button if it is in the program behind.

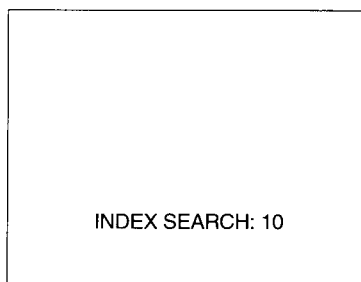

- Enter skip search from the stop or playback mode.

- ① Load the tape with index signals, then play back or stop it depending on preference.
- ② Press the *INDEX* button.

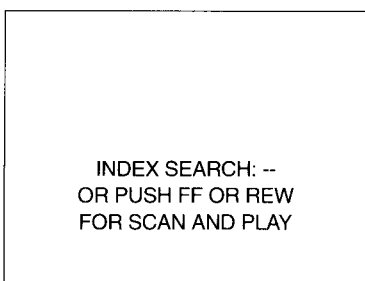

When the tape comes to the specified index signal it is played back automatically. The counter returns to the elapsed-time-on-tape read from the index signal read.

- ⑤ Press the *STOP* button to stop playback.

### Numbering the index signals

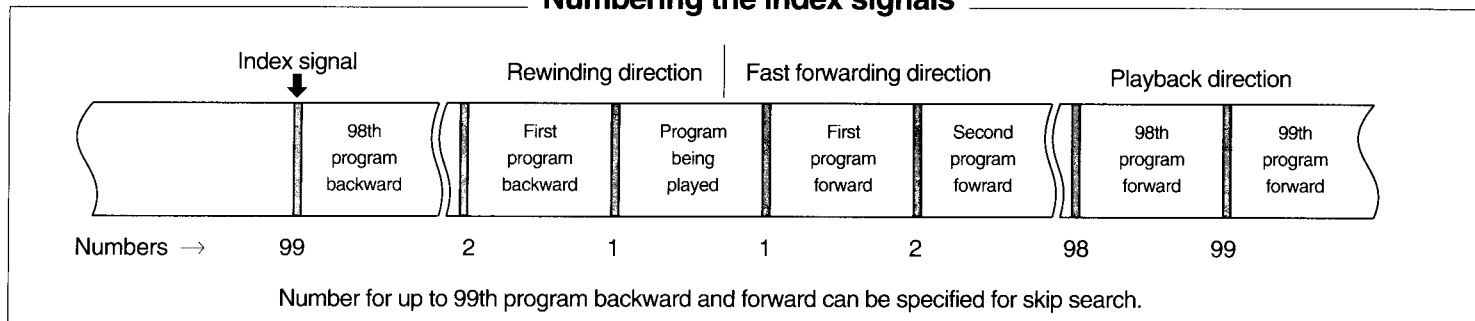

### Notes:

- The counter read for numbers reduces by one each time an index signal is skipped.

# SPECIALIZED OPERATIONS(continued)

## Skip Search 2 (Using the FRAME button)

This set has a convenient function to search a picture speedily (Forward Picture-Search) during playback.

Case 1: If you press the FRAME (SKIP SEARCH) button once on the remote control during playback, FPS (Forward-Picture Search) mode is automatically enabled for a few seconds. FPS for a few seconds actually equals about one minute of the pre-recorded picture time.

Case 2: Additionally, if you press the button twice in a row within 2 seconds, FPS is extended twice than the Case 1. The actual elapsed time it takes SP tapes to be performed by SKIP SEARCH 2 is different from SLP tapes. (SP TAPES is about 3 times longer than SLP TAPES.) After the SKIP SEARCH 2 is ended, the mode automatically returns to playback.

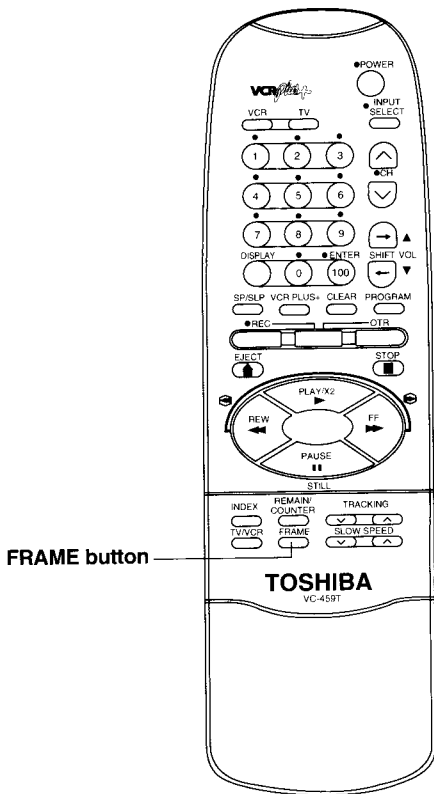

## Repeat Play

VCR plays countless times repetition from tape start to end.

1. Press the *PROGRAM* button, the MENU will appear on TV screen.
2. Press the 4 button, the VCR FUNCTION SET UP will appear on TV screen.
3. Press the 3 button to select the REPEAT PLAY function ON.

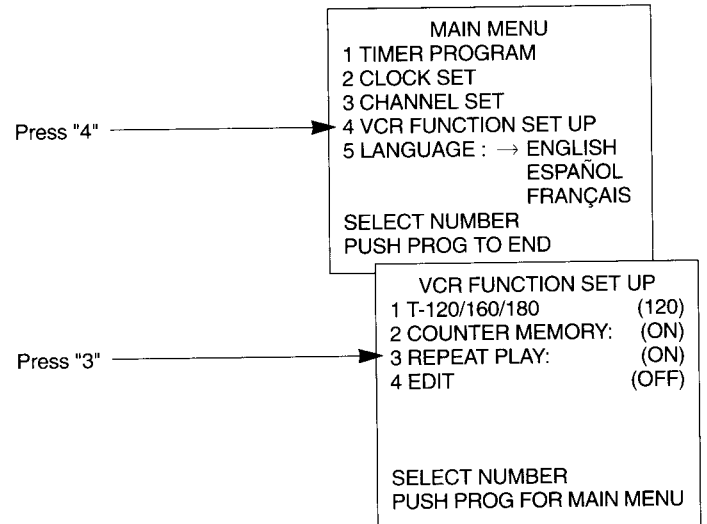

4. REPEAT PLAY indicator( ) will light in the VCR's display panel, after you choose REPEAT feature on the SET UP screen.
5. Press the *PROGRAM* button twice, to return to normal screen.
6. Press the *PLAY* button to begin playback.
7. If the end of the tape is reached in PLAY mode, the tape will be rewinded automatically and start playing from the beginning again.

### Note:

- Pressing the *POWER* or *INDEX* button while in the REPEAT PLAY ON mode switches the mode to REPEAT PLAY OFF.

# SPECIALIZED OPERATIONS(continued)

## Remaining Tape Display Function

This function displays the remaining time on the tape. This may help you to plan ahead. This function is activated from the PLAY, REC, FF or REW mode.

- ① Load cassette into the cassette compartment. The VCR is turned on automatically.
- ② On the remote control, press the PROGRAM button, the MENU will appear on the TV screen.
- ③ On the remote control, press the 4 button. This VCR FUNCTION SET UP will appear on the TV screen.

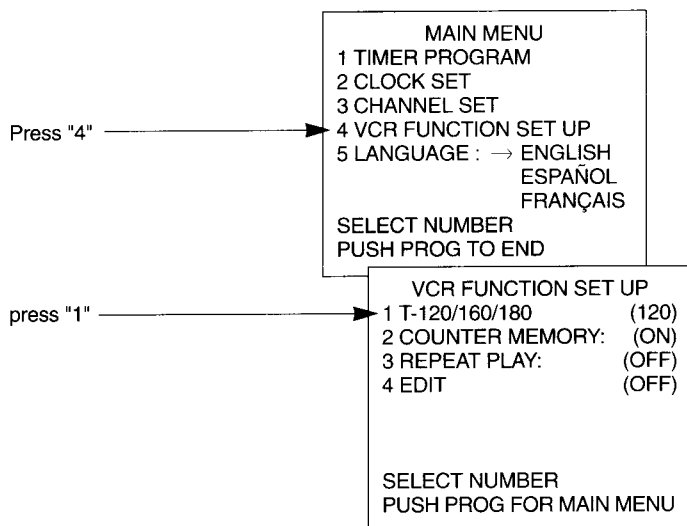

T-180: When using tape type T-180

T-160: When using tape type T-160

T-120: When using tape type T-120 or shorter one

To enter T-180, T-160 or T-120, press the "1" button cyclically.

- ④ Press the PROGRAM button twice to resume the normal screen.
- ⑤ Press the DISPLAY button once to display the normal displays on the TV screen.
- ⑥ Press the DISPLAY button again(while the normal display still appears on the TV screen) to display only the time counter on the TV screen. The time counter will remain on the TV screen.

- ⑦ Press the PLAY button or the REC button.
- ⑧ Press the REMAIN/COUNTER button. The VCR starts to calculate the remaining time on tape. Tape runs for a while for calculation.

The counter enters into the calculation mode from the time counter display mode.

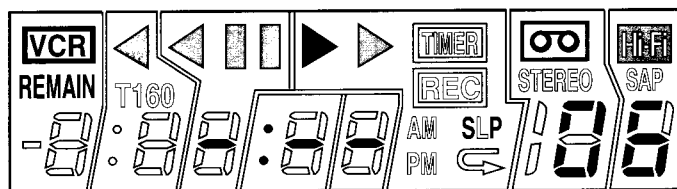
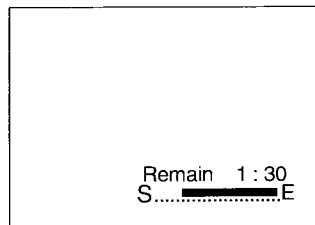

- ⑨ The calculation is completed within 1 minute at the most. The remaining time on the tape is indicated. (The example shows the remaining time is 1 hour 30 minutes.)

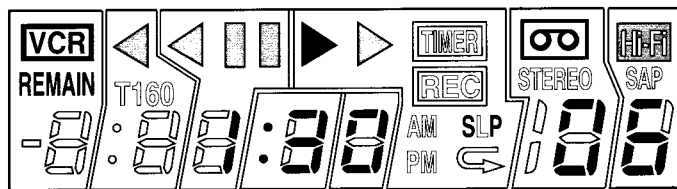

Remaining Time

Press the REMAIN/COUNTER button again and the counter changes from displaying the remaining time on the tape to the time counter.

## Notes:

- During the remaining time on the tape is indicated, when the COUNTER button is pressed, or when the tape is being removed, the counter returns to indicate the elapsed time.
- The remaining time displayed is approximate time.
- During recording, the remaining time is calculated based on the recording mode, SP or SLP, which is selected by the SP/SLP button.
- During playback, the remaining time is calculated based on the playback mode(SP/SLP speed).
- The remaining time can be displayed during FF/REW.

# SPECIALIZED OPERATIONS(continued)

## Copying VCR Recording(using the EDIT ON/OFF) Function

You can dub the tape for editing by connecting this VCR to another VCR.

### Using this VCR for playback (see p. 25-27)

- ① Playback VCR: Set the EDIT ON/OFF function to "ON".
- ② Recording VCR: Press the record button, then the pause button to enter the recording pause mode.
- ③ Playback VCR: Press the *PLAY* button to activate play.
- ④ Recording VCR: Cancel the pause mode to activate recording.
- ⑤ Both VCRs: To terminate recording, press the stop button on the VCRs, Copying is completed.

### Using this VCR for recording(see p. 42)

- ① Recording VCR: Set the EDIT ON/OFF function to "ON", if possible.
- ② Recording VCR: Press the *REC* button, then the *PAUSE/STILL* button to enter the pause mode.
- ③ Playing VCR: Press the play button to activate play.
- ④ Recording VCR: Press the *PAUSE/STILL* button again to cancel the pause mode to start recording.
- ⑤ Both VCRs: To terminate recording, press the stop button on both VCRs. Copying is completed.

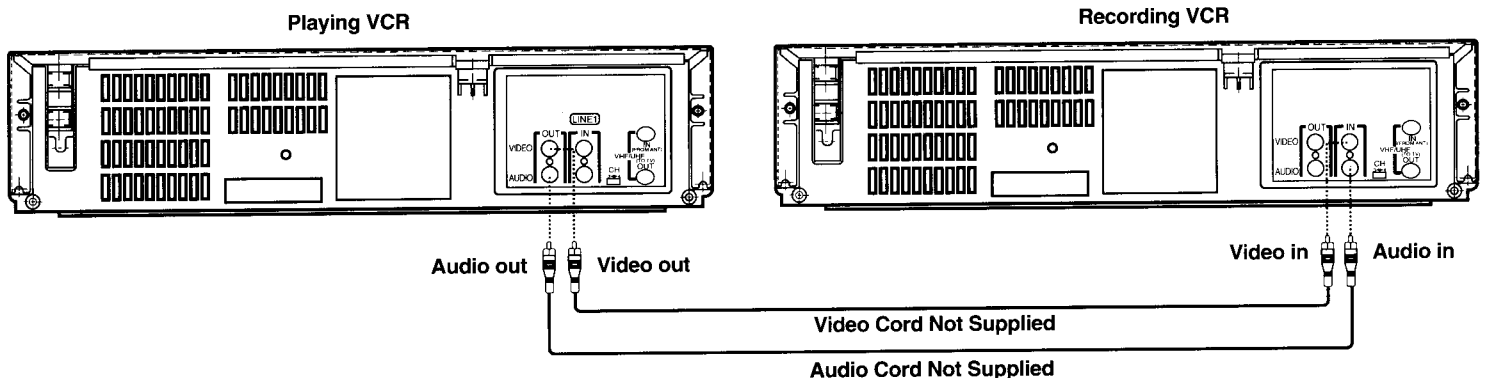

### ■ EDIT ON/OFF function

1. Press the PROGRAM button.
2. To display VCR FUNCTION SET UP screen, press the "4" button.
3. To display EDIT ON/OFF function, press the "4" button.

| VCR FUNCTION SET UP |       |
|---------------------|-------|
| 1 T-120/160/180     | (120) |
| 2 COUNTER MEMORY:   | (ON)  |
| 3 REPEAT PLAY:      | (OFF) |
| 4 EDIT              | (OFF) |

SELECT NUMBER  
PUSH PROG FOR MAIN MENU

When dubbing is completed, set the EDIT ON/OFF function to "OFF". If it remains at "ON" when the tape is played back, picture quality is not satisfactory.

**WARNING:** Tapes can only be copied and used in accordance with applicable copyright laws. But, if the tape is covered by a copyright, it is illegal to copy it and/or charge an entrance fee to see it.

### Note:

- In general, picture quality deteriorates somewhat in the dubbed tape. It is best to use the SP mode.



# TROUBLE CHECKS

Sometimes problems can be easily solved by checking a few basic things. Check below before you call for help or take your VCR to an Authorized TOSHIBA VCR Service center.

It could save you time and money. If service should be necessary. Authorized TOSHIBA VCR Service centers are trained and equipped to furnish it.

| Trouble   | Checks and Adjustments  |
|---|---|
| No Power  | <ul style="list-style-type: none"> <li>• Check to see if the VCR is plugged into an operating outlet.</li> </ul>  |
| VCR Does Not Respond to Remote Control                        | <ul style="list-style-type: none"> <li>• Weak battery in remote control.</li> <li>• Remote control not aimed at the VCR or there is an obstruction between them.</li> <li>• Press the VCR button on the remote control for changing to the VCR mode.</li> </ul>   |
| Remote No Longer Controls a TOSHIBA TV                        | <ul style="list-style-type: none"> <li>• Remote accidentally programmed for different brand of TV. Press TV and "1" buttons at the same time on the remote control to re-program. <i>Details are on page 21-22.</i></li> </ul>  |
| Remote No Longer Controls a Compatible TV(Other Than TOSHIBA) | <ul style="list-style-type: none"> <li>• Remote control may need to be re-programmed after batteries are changed. <i>See page 21-22.</i></li> <li>• Check batteries in remote control.</li> </ul>   |
| Poor or No Picture for Normal TV Viewing                      | <ul style="list-style-type: none"> <li>• <b>VCR</b> indicator is on. Press the <i>TV/VCR</i> button to turn it off.</li> <li>• TV monitor/receiver set to "video input". Switch TV to an active channel.</li> <li>• Carefully check antenna connections.</li> </ul>   |
| Snowy or No Picture During Playback                           | <ul style="list-style-type: none"> <li>• Press one of the <i>TRACKING</i> buttons on the remote control to adjust tracking.</li> <li>• <b>VCR</b> indicator not on. Press <i>TV/VCR</i> button to turn it on.</li> <li>• Make sure the TV channel selector matches the channel you have selected with the <i>CH3/CH4</i> switch on the back of the VCR(3 or 4).</li> <li>• Make sure the TV is fine tuned.</li> <li>• Check the video cable connections between the VCR and TV monitor/receiver.</li> <li>• Make sure the TV monitor/receiver is set to the "video input" channel.</li> <li>• Try another tape.</li> <li>• Dirty tape has left deposits on VCR's heads. <i>See page 24 for head cleaning.</i></li> <li>• Some snow/streaks are normal during search, slow motion and stop-action playback.</li> </ul> |
| Streaks in Picture During Normal Playback                     | <ul style="list-style-type: none"> <li>• Press one of the <i>TRACKING</i> buttons on the remote control to move streaks up or down and out of the picture.</li> <li>• Tape stretched (poor quality or worn out).</li> </ul>   |
| Will Not Record or Play                                       | <ul style="list-style-type: none"> <li>• No cassette in VCR.</li> <li>• Eject and re-insert cassette.</li> <li>• Broken tape-try another cassette.</li> </ul>   |
| Will Not Record   | <ul style="list-style-type: none"> <li>• VCR is in pause mode. Press the <i>PAUSE</i> button.</li> <li>• Record-protect(safety) tab removed from cassette.</li> <li>• Make sure "L1(L2)" indicator is turned off in VCR's display panel for normal recording from the VCR's tuner. Press the <i>INPUT SELECT</i> button to turn off "L1(L2)" indicator.</li> </ul>  |
| Timer Recording Not Made                                      | <ul style="list-style-type: none"> <li>• Program entered incorrectly(wrong channel or times).</li> <li>• Power interruption. (Clock on the VCR's front panel will show "--:--".)</li> <li>• Clock was not set accurately(check AM/PM).</li> <li>• Program exceeded tape's length or tape was not rewound beforehand.</li> <li>• VCR was not turned off at the time recording was to start.</li> <li>• No tape in VCR or cassette's record-protect(safety) tab broken off.</li> </ul>  |
| Tape Stops Before Complete Rewind                             | <ul style="list-style-type: none"> <li>• Press the <i>REW</i> button again. Tape rewinds only to "0:00:00M" ("0:00:00" in VCR's display panel) when counter memory is turned on. <i>Details are on page 27.</i></li> </ul>  |
| Rewind Does Not Operate                                       | <ul style="list-style-type: none"> <li>• Tape already rewound.</li> </ul>   |
| Clock shows Incorrect Time or Date                            | <ul style="list-style-type: none"> <li>• Power interruption. (Clock on the front panel will show "--:--".)</li> <li>• Clock was not set accurately (check AM and PM).</li> <li>• Clock display shows recording time remaining for OTR recording.</li> </ul>   |
| VCR Makes Noise When Stopped                                  | <ul style="list-style-type: none"> <li>• VCR is removing tape from heads. This is normal. The cylinder head inside the VCR will continue to rotate for about 5 minutes after you put the VCR in the stop mode or turn it off.</li> </ul>  |
| Will Not Auto Program Active Channels Correctly               | <ul style="list-style-type: none"> <li>• CHANNEL SET is not set correctly. Press "1" button on the CHANNEL SET menu to turn on <i>CABLE</i> if you have connected a cable-TV system. Turn <i>ANTENNA</i> on for a home antenna on the CHANNEL SET menu.</li> </ul>  |
| Can Not Select Channels Over 69                               | <ul style="list-style-type: none"> <li>• Channels over 69 can only be selected if available from your cable-TV system.</li> </ul>   |
| Tape Plays Back in Slow Motion                                | <ul style="list-style-type: none"> <li>• Press the <i>PLAY</i> button to normal playback.</li> </ul>  |
| Poor Picture for Cable TV Viewing                             | <ul style="list-style-type: none"> <li>• Change the channel on the VCR, then return the channel to 3/4.</li> </ul>  |

## Cleaning the VCR

Dust exposed surfaces as required, using a soft cloth or the dusting attachment of your vacuum cleaner. Occasionally use the vacuum cleaner to remove dust from the ventilation, holes on the top, back, sides, and bottom of the cabinet.

Some of the plastic surfaces are easily scratched, and they can be marred by alcohol and various solvents. Avoid excessive use of oil-based furniture polishes since the materials used in the cabinet are non-porous and the residue will accumulate more dust.

## Design Specifications

|                                      |   |
|--------------------------------------|---|
| <b>Format:</b>                       | VHS   |
| <b>Record/Playback System:</b>       | Video : 4-Head record/playback system<br>Audio: Mono record/playback system         |
| <b>Video Signal System:</b>          | EIA standard: NTSC color  |
| <b>Antenna:</b>                      | 75-ohm external VHF/UHF combined Antenna terminal                                   |
| <b>Tuner:</b>                        | USA: 181 channels (125 cable channels)<br>CANADA: 178 channels (122 cable channels) |
| <b>Type:</b>                         | Auto-programming frequency synthesis  |
| <b>Power Requirement:</b>            | 120AC, 60Hz   |
| <b>Power Consumption:</b>            | 21 watts  |
| <b>Dimension:</b>                    | 89.5mm high (3.5 inches)<br>380mm wide (15.2 inches)<br>331mm deep (13.2 inches)    |
| <b>Weight:</b>                       | 4.33Kg (9.52 lbs)   |
| <b>Storage Temperature Range:</b>    | -22° F to + 149° F  |
| <b>Operating Temperature Range :</b> | +41° F to + 104° F  |

Specifications and features are subject to change without notice.

# LIMITED WARRANTY

## TOSHIBA VIDEO CASSETTE RECORDER

Toshiba America Consumer Products, Inc. ("TACP") and Toshiba Hawaii Inc. ("THI") make the following limited warranties. These limited warranties extended to the original consumer purchaser or any person receiving this set as a gift from the original consumer purchaser and to no other purchaser or transferee.

### Limited Ninety (90) Day Warranty

TACP and THI warrant this product against defects in materials or workmanship for a period of ninety (90) days after the date of original retail purchase. During this period, TACP and THI will repair a defective product or part, without charge to you. You must deliver the entire product to a TACP/THI Service Center. You pay for all transportation and insurance charges for the set to and from the Service Center.

### Limited One (1) Year Warranty

TACP and THI further warrant the parts in this product against defects in materials or workmanship for a period of one year after the date of original retail purchase. During this period, TACP and THI will replace a defective part without charge to you, except that if a defective part is replaced after ninety (90) days from the date of the original retail purchase you pay labor charges involved in the replacement. You must also deliver the entire product to one of the TACP/THI Service Centers. You pay for all transportation and insurance charges for the set to and from the Service Center.

### Owner's Manual and Registration Card

You should read the owner's manual thoroughly before operating this product. You should also insure that your name and address are on file as owners of a TACP/THI product by completing and mailing the enclosed registration card within ten days after you, or the person who has given you this product as a gift, purchased this product.

### Step-By-Step Procedures - How to Obtain Warranty Service

#### IN THE CONTINENTAL UNITED STATES...

Should your unit require service or parts, CALL

This is one way to enable TACP/THI to establish the date of purchase of the product, as well as to provide you with better customer service and improved products. Failure to return the card will not affect your rights under this warranty so long as you retain other proof of purchase such as a bill of sale.

### Your Responsibility

The above warranties are subject to the following conditions:

- (1) You must retain your bill of sale or provide other proof of purchase. Completing and mailing in the enclosed registration card within ten days after the original retail purchase is one way of providing such other proof of purchase.
- (2) You must notify an Authorized TACP/THI Service Station within thirty (30) days after you discover a defective product or part.
- (3) All warranty servicing of this product must be made by an Authorized TACP/THI Service Station.
- (4) These warranties are effective only if the product is purchased and operated in the U.S.A.
- (5) Labor service charges for set installation, set up, adjustment of customer controls and installation of repair or antenna systems are not covered by this warranty. Reception problems caused by inadequate antenna systems are your responsibility.
- (6) Warranties extend only to defects in materials or workmanship as limited above and do not extend to any product or parts which have been lost or discarded by you or to damage to products or parts caused by misuse, accident, improper installation, improper maintenance or use in violation of instructions furnished by us; or to units which have been altered or modified without authorization of TACP/THI or to damage to products or parts there of which have had the serial number removed, altered, defaced or rendered illegible.



### HAWAII

Toshiba Hawaii Inc.  
Service Department  
327 Kamakee Street  
Honolulu, HI 96814  
Phone Number  
: (808) 521-5377

### IN THE EVENT A PROBLEM SHOULD DEVELOP WITH YOUR PRODUCT, PLEASE PROCEED AS FOLLOWS:

- (1) Refer to the troubleshooting guide in your owner's manual. This check list may solve your problem.
- (2) Contact one of the TACP/THI Service Centers listed below for warranty service or call the TACP toll free number 1-800-631-3811 within thirty (30) days after you find a defective product or part.
- (3) Arrange for the delivery of the product to the Authorized TACP/THI Service Center. Products shipped to the Service Center must be insured and safely and

securely packed, preferably in the original shipping carton, and a letter explaining the defect and also a copy of the bill of sale or other proof of purchase must be enclosed. All transportation and insurance charges must be prepaid by you. (See Packing and Shipping instructions on TOSHIBA SERVICE PROCEDURE).

- (4) If you have any question about service, please contact one of the following TACP/THI Service Centers:

#### EAST

82 Totowa Road  
Wayne, NJ 07470  
Phone Number:  
(201) 628-8000

#### SOUTHEAST

490 Armour Circle, N.E.  
Atlanta, GA 30324  
Phone Number:  
(404) 872-6955

#### MIDWEST

1010 Johnson Drive  
Buffalo Grove, IL  
60089  
Phone Number:  
(708) 541-9400

#### SOUTHWEST

1421 champion Drive  
Suite 304  
Carrollton, TX 75006  
Phone Number:  
(214) 243-1367

#### WEST

5490 E. Francis Street  
Ontario, CA91761  
Phone Number:  
(714) 988-5303

### IMPORTANT: PACKING AND SHIPPING INSTRUCTIONS

When you send the product to a service center, you must use the original carton box and packing material, then insert the original carton box containing the unit into another carton, using more packing material.

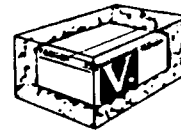

**ALL WARRANTIES IMPLIED BY STATE LAW, INCLUDING THE IMPLIED WARRANTIES OF MERCHANTABILITY AND FITNESS FOR A PARTICULAR PURPOSE, ARE EXPRESSLY LIMITED TO THE DURATION OF THE LIMITED WARRANTIES SET FORTH ABOVE.** Some states do not allow limitations on how long an implied warranty lasts, so the above limitation may not apply to you. **WITH THE EXCEPTION OF ANY WARRANTIES IMPLIED BY STATE LAW AS HEREBY LIMITED, THE FOREGOING EXPRESS WARRANTY IS EXCLUSIVE AND IN LIEU OF ALL OTHER WARRANTIES, GUARANTEES, AGREEMENTS AND SIMILAR OBLIGATIONS OF MANUFACTURER OR SELLER WITH RESPECT TO THE REPAIR OR REPLACEMENT OF ANY PRODUCT OR PARTS.**

**IN THE EVENT SHALL TACP OR THI BE LIABLE FOR CONSEQUENTIAL OR INCIDENTAL DAMAGES.** Some states do not allow the exclusion or limitation of incidental or consequential damages so the above limitation may not apply to you.

No person, agent, distributor, dealer, service station or company is authorized to change, modify or extend the terms of these warranties in any manner whatsoever. The time within which an action must be commenced to enforce any obligation of TACP and THI arising under this warranty or under any statute, or law of the United States or any state thereof, is hereby limited to one year from the date you discover or should have discovered, the defect. This limitation does not apply to implied warranties arising under state law. Some states do not permit limitation of the time within which you may bring an action beyond the limits provided by state law so the above provision may not apply to you. This warranty gives you specific legal rights and you may also have other rights which vary from state to state.

**TOSHIBA AMERICA CONSUMER PRODUCTS, INC.**

Printed in Korea 70795990



**TOSHIBA**  
...In Touch with Tomorrow