

TOSHIBA

OWNER'S MANUAL

10 CHANNEL SCANNING CORDLESS TELEPHONE

FT-6003 / FT-6003 BK

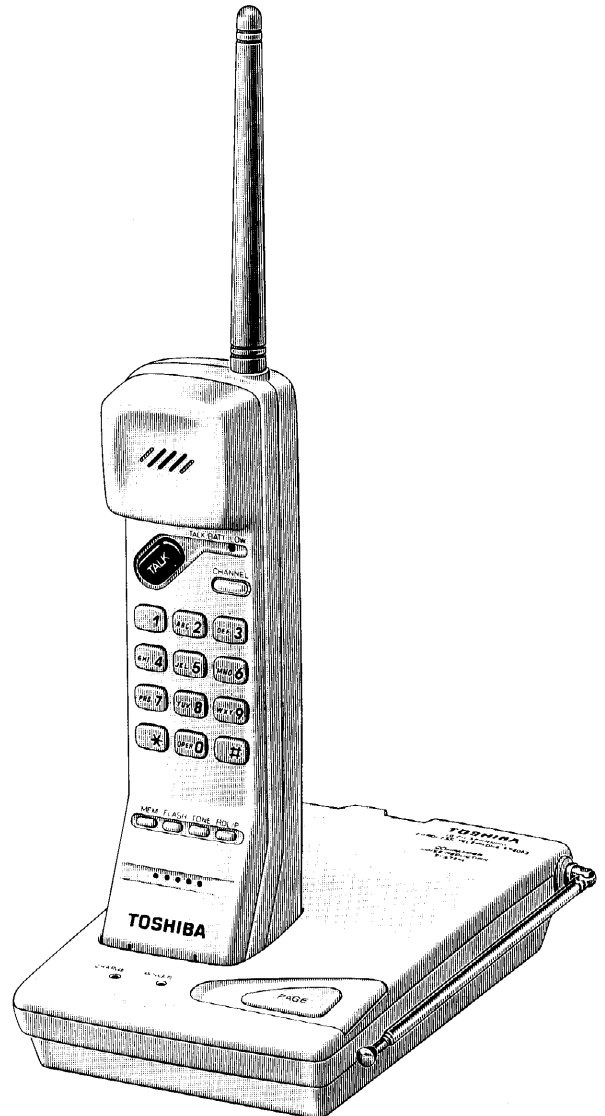

Should your unit require service, please refer to the "Toshiba service procedure" in your owner's manual.

IMPORTANT SAFETY INSTRUCTIONS

When using your telephone equipment, basic safety precautions should always be followed to reduce the risk of fire, electric shock and injury to persons, including the following:

1. Read and understand all instructions.
2. Follow all warnings and instructions marked on the product.
3. Unplug this product from the wall outlet before cleaning. Do not use liquid cleaners or aerosol cleaners. Use a dry cloth for cleaning.
4. Do not use this product near water, for example, near a bath tub, wash bowl, kitchen sink, or laundry tub, in a wet basement, or near a swimming pool.
5. Do not place this product on an unstable cart, stand, or table. The telephone may fall, causing serious damage to the telephone.
6. Slots and openings in the cabinet and the back or bottom are provided for ventilation, to protect it from overheating, these openings must not be blocked or covered. The openings should never be blocked by placing the product on the bed, sofa, rug, or other similar surface. This product should never be placed near or over a radiator or heat register. This product should not be placed in a built-in installation unless proper ventilation is provided.
7. This product should be operated only from the type of power source indicated on the marking label. If you are not sure of the type of power supply to your home, consult your dealer or local power company.
8. Do not allow anything to rest on the power cord. Do not locate this product where the cord will be abused by persons walking on it.
9. Do not overload wall outlets and extension cords as this can result in the risk of fire or electric shock.
10. Never push objects of any kind into this product through cabinet slots as they may touch dangerous voltage points or short out parts that could result in a risk of fire or electric shock. Never spill liquid of any kind on the product.
11. To reduce the risk of electric shock, do not disassemble this product, but take it to a qualified service personnel when some service or repair work is required. Opening or removing covers may expose you to dangerous voltages or other risks. Incorrect reassembly can cause electric shock when the appliance is subsequently used.
12. Unplug this product from the wall outlet and refer servicing to qualified service personnel under the following condition:
 - A. When the power supply cord plug is damaged or frayed.
 - B. If liquid has been spilled into the product.
 - C. If the product has been exposed to rain or water.
 - D. If the product does not operate normally by following the operating instructions. Adjust only those controls, that are covered by the operating instructions because improper adjustment of other controls may result in damage and will often require extensive work by a qualified technician to restore the product to normal operation.

E. If the product has been dropped or the cabinet has been damaged.

F. If the product exhibits a distinct change in performance.

13. Do not use the telephone to report a gas leak in the vicinity of the leak.

CAUTION: TO REDUCE THE RISK OF FIRE OR INJURY TO PERSONS BY BATTERY, READ AND FOLLOW THESE INSTRUCTIONS.

1. Use only the appropriate type and size battery pack specified in the instruction manual provided for this product.
2. Do not dispose of the battery pack in a fire. The cell may explode. Check with State and local codes for possible special disposal instructions.
3. Do not open or mutilate the battery pack. Released electrolyte is corrosive and may cause damage to the eyes or skin. It may be toxic if swallowed.
4. Exercise care in handling battery in order not to short the battery with conducting materials such as rings, bracelets, and keys. The battery or conductor may overheat and cause burns.
5. Charge the battery pack provided with or identified for use with this product only in accordance with the instructions and limitations specified in the instruction manual provided for this product.
6. Observe proper polarity orientation between the battery pack and battery charger.

SAVE THESE INSTRUCTIONS

① INTRODUCTION

Toshiba America takes pride in presenting the FT-6003, one of the finest telephones available. Intelligent design, superb craftsmanship, and the latest technological advances have been combined to provide you with a telephone that is easy to operate and will provide you with years of dependable service. Please take the time now to read your Owner's Manual carefully, so that you may enjoy the many convenient features of your FT-6003 telephone.

FEATURES

- Telephone numbers can be dialed using tones, rotary dial type pulses, or a combination of both.
- Remote channel scan (10 channels) avoid interference.
- Compandor noise reduction circuit minimizes any noise from radio or other appliances as much as possible.
- Programmable Digital Security Codes (65,536) prevent unauthorized calls.
- Automatic and manual dialing can be combined within the same dialing sequence.
- Up to 20 telephone numbers can be stored in memory, each with a maximum length of 16 digits.
- Pauses may be programmed, where needed, in the middle of an automatic dialing sequence.
- Memory locations can be accessed individually or successively, in any order or combination, all in one dialing sequence.
- Combination storage is available for simplified memory programming and expanded number range.
- Compatibility with alternate long distance services.
- Automatic Redial button for access to last dialed telephone number (up to 32 digits).
- Designed for use as a wall phone or desk phone.
- Flash function for convenient hook-switch control.
- Hearing Aid Compatibility lets you use your cordless telephone if you wear a hearing aid equipped with a T (telephone) switch.
- Page sounds a tone from the base unit to the handset.
- Battery low indicator.
- 3 weeks long life battery.

IMPORTANT

Before using your new phone please follow these instructions

The Digital Security Code, which enables the handset and the base unit to communicate with each other, will not activate unless the handset's battery pack is charged in the base unit.

The correct sequence needed to activate the digital security code is as follows:

- ① Connect the AC adaptor plug to the DC jack on the rear of your base unit and plug into AC outlet of home electricity in an area where the unit will not be disturbed and power will not be interrupted for 12 to 16 hours.
- ② Install the battery pack in the handset.
- ③ Leave the handset in the base unit overnight **12 hours to 16 hours to ensure a full charge.**

When replacing the battery pack, please follow the same procedure.

WARNING

TO REDUCE THE RISK OF ELECTRIC SHOCK, DO NOT REMOVE COVER (OR BACK). NO USER SERVICEABLE PARTS INSIDE. REFER SERVICING TO QUALIFIED SERVICE PERSONNEL.

DO NOT PRESS ANY OF THE BUTTONS WHILE YOU ARE SPEAKING.

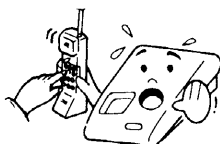

DO NOT PULL OUT THE PLUG WHILE YOU ARE SPEAKING.

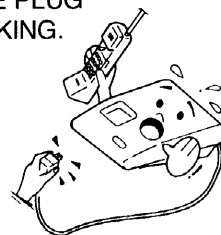

CLEAN WITH A DRY CLOTH.

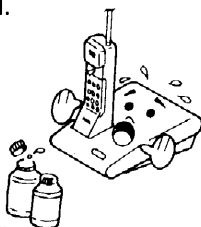

Do not use benzine or thinner.

DO NOT EXPOSE TO HEAT.

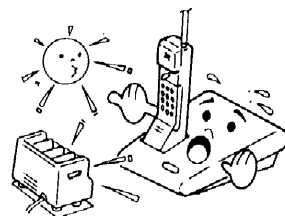

Clean the battery charging contacts in handset and base unit regularly with a dry cloth so that sufficient contact is made.

PRECAUTIONS

- **Before initial use, charge the battery pack in the battery compartment of the handset for approximately 12 to 16 hours without any interruption of the charge cycle whatsoever.**
(For details, refer to page 12 "CHARGING THE HANDSET'S BATTERY PACK")
- Operate the AC adaptor on 120V AC, 60 Hz.
- Use the AC adaptor supplied for this unit. Do not use any other AC adaptor.
- Unplug the AC adaptor from the wall outlet when the cordless telephone system is not to be used for an extended period of time. To disconnect the AC adaptor, pull it out by grasping the body. Never pull it by the cord.
- Do not install the base unit in a location near a heat source such as radiators or airducts, or in a place subject to direct sunlight, excessive dust, moisture, rain, mechanical vibration, or shock.
- Do not place the units on or near a TV set or a personal computer, as these units may interfere with each other.
- Should any liquid or solid object fall into the base unit, unplug the unit and have it checked by qualified service personnel before operating the unit any further.
- This unit is designed and approved for single lines only. It should not be connected to multiple lines or a coin telephone or party lines.

If you have any question or problem concerning your set that is not covered in this manual, please consult the nearest Toshiba Service Station authorized to service telephone terminal equipment.
For Customer Service, Call **1-800-631-3811**.

HANDSET CONTROLS AND FUNCTIONS

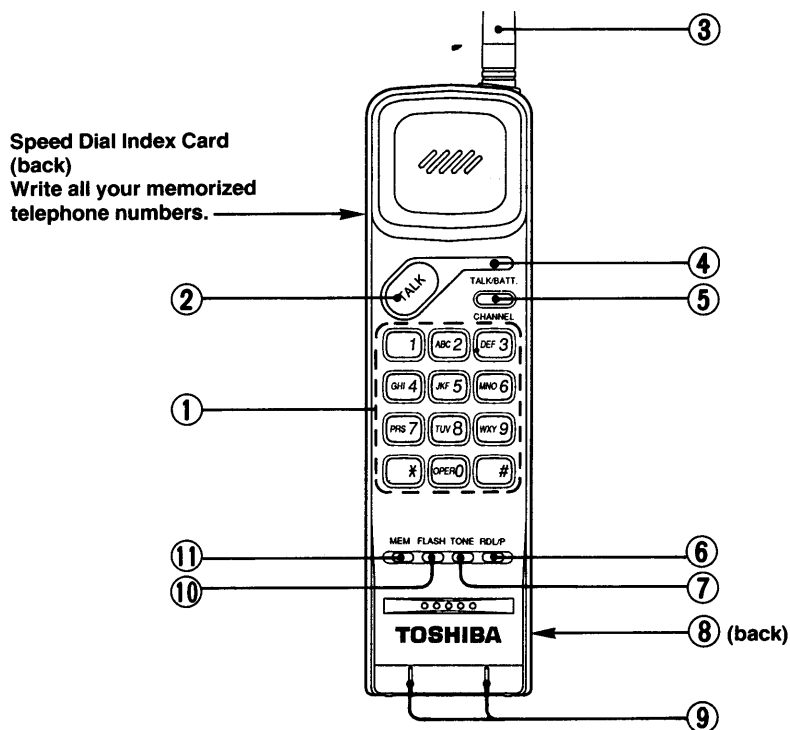

- ① **0-9, *, # Buttons** — Used for dialing numbers, storing numbers to memory and setting the digital security code.
- ② **TALK Button** — Places the handset into talk mode or back to standby when used away from the charging the base unit.
- ③ **HELICAL ANTENNA** — Durable high-gain helical antenna.
- ④ **TALK/BATT. LOW LED** — Lights when the handset is in the talk mode and blinks on and off with a short beep tone every 3 seconds when the handset battery needs to be recharged.
- ⑤ **CHANNEL SELECTOR Button** — Selects the best channel when interference noise is heard.
- ⑥ **REDIAL/PAUSE Button** — Redials the last number dialed, or inserts a pause into memory dialing sequences.
- ⑦ **TONE Button** — When the TONE/PULSE switch on the rear of the base unit is in **pulse**; one touch of this button allows tone dialing for access to long distance services, etc. This also functions when storing numbers to memory. (The pulse to tone override works on each individual call).
- ⑧ **Rechargeable Battery Pack** — User replaceable and rechargeable for long, trouble-free service.
- ⑨ **Charging Contacts** — Provides power to charge the handset when it is placed on the base unit.
- ⑩ **FLASH Button** — Sends a timed hookflash on the telephone line for accessing telephone company services such as call waiting, etc.
- ⑪ **MEMORY Button** — Used when storing numbers to memory and setting the digital security code.

BASE UNIT CONTROLS AND FUNCTIONS

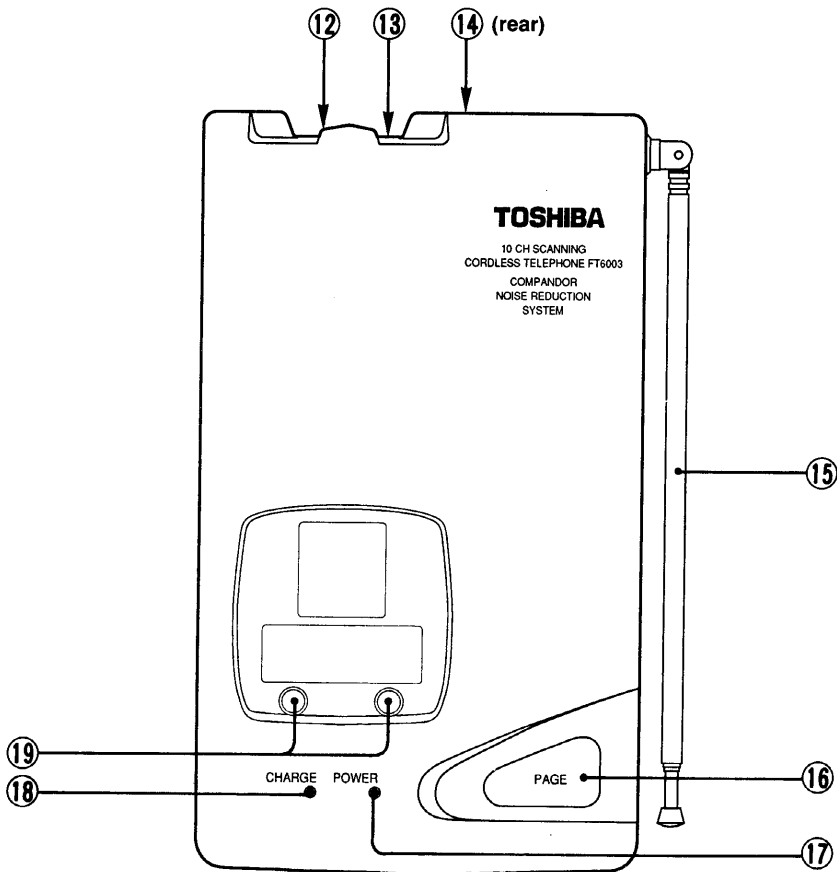

- ⑫ **Telephone Modular Jack** — Plugs one end of the telephone line cord into a standard RJ11C telephone line jack and the other end into this jack for connecting the base unit to the telephone line.
- ⑬ **DC Jack** — Plugs one end of the AC adaptor into a standard wall outlet and the other end into the rear of the base unit to provide power for the base unit and charging for the handset.
- ⑭ **TONE/PULSE Switch** — Selects either tone dialing or pulse dialing.
- ⑮ **Base Antenna** — Collapsible antenna provides maximum range when fully extended.
- ⑯ **PAGE Button** — Sounds a tone at the handset.
- ⑰ **POWER LED** — Lights when power is supplied to the unit from the AC outlet.
- ⑱ **CHARGE LED** — Lights when the handset is fully seated on the charge contacts of the base unit.
- ⑲ **Charging Contacts** — Provides power to charge the handset when it is placed on the base unit.

② INSTALLATION

CONNECTING

There are three basic types of phone wall outlets you may find in your home:

(1) Modular USOC: RJ11C jack, (2) 4-prong jack, or (3) hard-wired type

(1) If you have a modular wall jack,

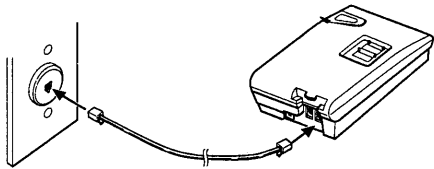

- ① Plug one end of the telephone line cord into the base modular jack on the rear of the base unit.
- ② Plug the other end of the telephone line cord into the modular wall jack.

(2) If the existing receptacle is a 4-prong jack,

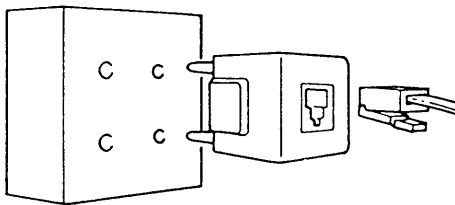

An adaptor (not included) is required.

The adaptor plugs into the 4-prong jack and the phone's modular plug plugs into the adaptor.

(3) If your phone cord is hard-wired into an outlet and you have no jack,

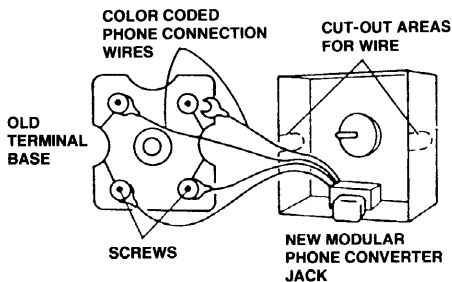

A modular jack converter (not included) is required, entailing some rewiring (namely, making color-coded connections).

Note

The dealer from whom you purchased your telephone or a telephone supply store can advise you regarding the proper adaptor or converter.

Notes

- Never install telephone wiring during a lightning storm.
- Never install telephone jacks in wet locations unless the jack is specifically designed for wet locations.
- Never touch uninsulated telephone wires or terminals unless the telephone line has been disconnected at the network interface.
- Use caution when installing or modifying telephone lines.
- If you experience an excessive amount of noise or static, try relocating the base away from the interference source i.e. TV, radio, appliances.

WALL-MOUNTING THE BASE

You can mount your cordless telephone's base unit on a wall using two provided screws.

- ① Cut out the template (see page 11) and use it as a guide for placement on the mount screws. ($3\frac{15}{16}$ inch apart).
- ② Thread the screws into the wall, letting the heads extend about $\frac{1}{5}$ inch.

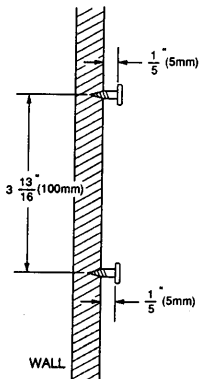

- ③ Route the phone cord and AC adaptor cord through the guides on the back of the base unit.

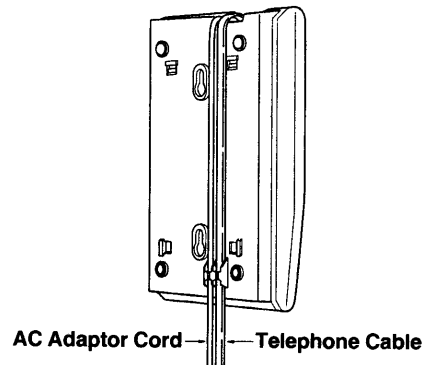

- ④ Place the base's keyhole slots over the two screws and gently push down on the base unit to lock it into place.

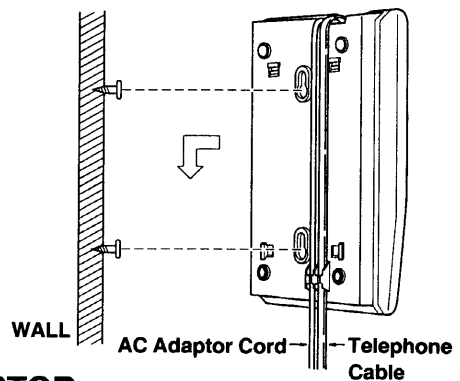

USING THE OPTIONAL WALL MOUNT ADAPTOR

This adaptor is designed to be used with the standard bell type wall mounting system. Align the installation hooks with the slots on the wall mount adaptor. Insert telephone in the adaptor and push down. Then, hook the wall mount adaptor with the base unit to the modular wall jack.

Note

To order this adaptor please call 1-800-631-3811.

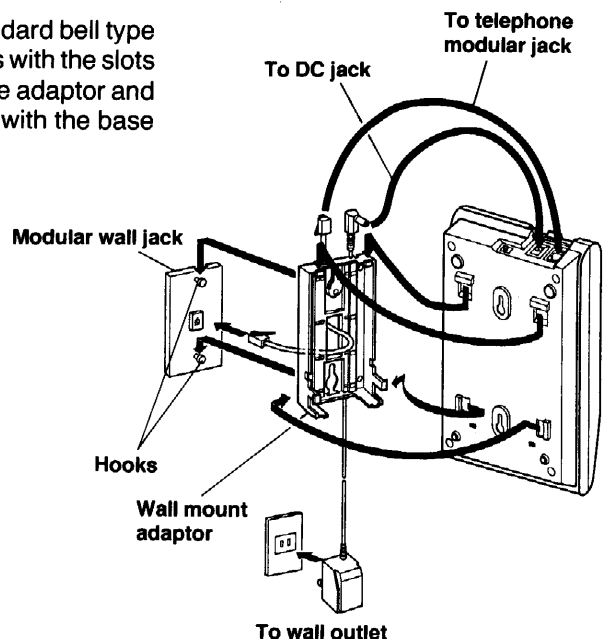

INSTALLING THE BATTERY PACK

Installing the battery pack in your FT-6003 is quick and easy. For trouble-free operation, please be sure to follow the instruction on page 12 "CHARGING THE HANDSET'S BATTERY PACK".

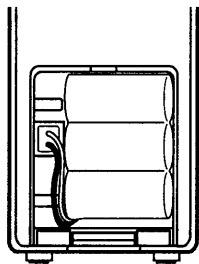
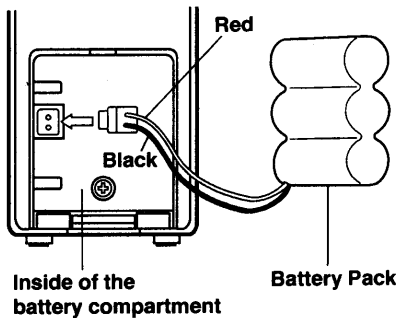

First, remove the battery compartment cover on the back of the handset by sliding it down.

- ① Plug the battery pack's connector into the connector in the battery compartment.

Notes

- Do not force the connectors together. They fit only one way.
- With the handset held upright, the black wire should be to the bottom side of the battery connection terminal, and the red wire should be to the upper side of the battery connection terminal.

- ② Place the battery pack in the battery compartment.
- ③ Replace the battery compartment cover by sliding it on.

Make sure not to get the wires from the battery pack caught in the cover.

Should the need arise to purchase Parts or Accessories, please call **1-800-631-3811** for the location of the nearest parts distributor.

* If replacing the battery, please check with State and local agencies for disposal of the old battery.

CONNECTING THE AC POWER

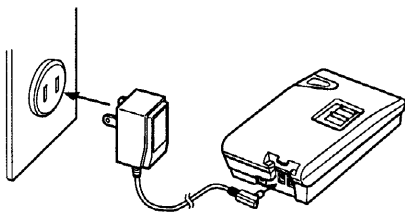

Connect the plug at the end of the AC adaptor to a standard 120V AC outlet and the other end to the rear of the base unit.

Make sure to route the AC adaptor cord where it will not create a trip hazard, or where it could become chafed and create fire or other electrical hazards.

Note

Do not attach the AC power supply cord to building surfaces using metal fittings.

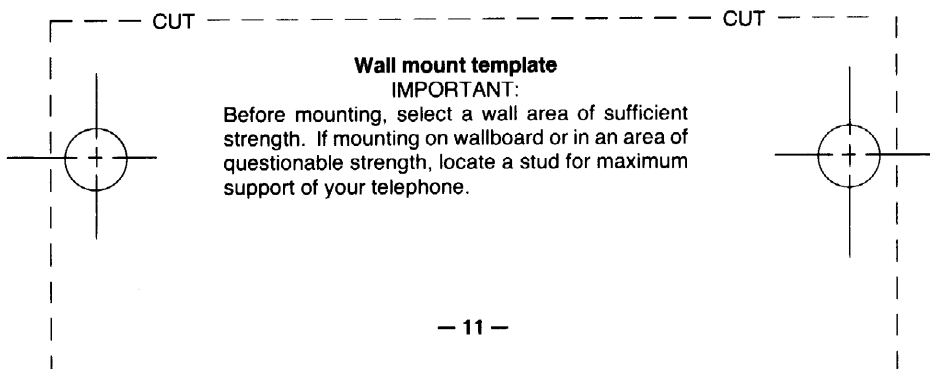

CHARGING THE HANDSET'S BATTERY PACK

The Ni-Cd battery pack supplied with the handset is manufactured and supplied in a non-charged condition. It is important that this type of battery receives its initial charge cycle without interruption. Any operation of the circuit connected to the battery constitutes an interruption. Before you try to use your handset for the first time, please comply with the following instructions:

For initial charging of an original or replacement battery, locate phone in an area where it can remain completely undisturbed (untouched).

You must charge its battery pack for approximately 12 to 16 hours.

Place the handset on the base unit. The CHARGE LED lights as the battery pack charges. If the LED does not light, be sure that the AC adaptor is plugged in and the handset is firmly placed on the base unit.

Notes

- The handset's battery pack does not charge properly if the charging contacts are dirty or tarnished. Clean the contacts occasionally with a dry cloth.
- The supplied rechargeable battery pack should last for several years, however, it eventually loses its ability to fully charge and you will need to replace it with a new one. You can order a replacement rechargeable battery pack at your local Toshiba dealer or authorized parts distributor. Call **1-800-631-3811**.

③ THE BASICS

With the FT-6003 telephone numbers can be dialed using tones, rotary type pulses, or a combination of both.

Pulse dialing is compatible with most local telephone company dialing systems. When your phone is in the Pulse mode, you will hear a tone for each number pressed, and then pulsing sounds such as those generated by a rotary dial phone.

Tone dialing provides the tone signals required for independent, low cost long distance and other special tone-dialing services. Tone dialing will work only in those areas where the local phone company offers Tone Service. Subscribing to that service generally requires an extra monthly charge.

TONE-PULSE SELECTION

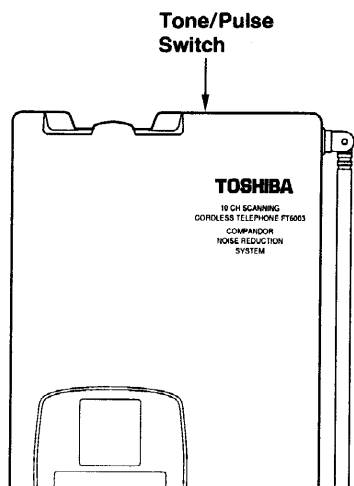

Set the TONE/PULSE switch located rear of the base unit for the type of service you have (tone or pulse). If you are not sure which type of service you have, do this simple test.

- ① Set TONE/PULSE switch to TONE position.
- ② Press the TALK button on the handset and listen for a dial tone.
- ③ Press any number other than 0. If the dial tone stops, you have Tone service. If the dial tone continues, you have Pulse service.
- ④ If you have Pulse service, set TONE/PULSE switch to PULSE position.

PLACING A CALL

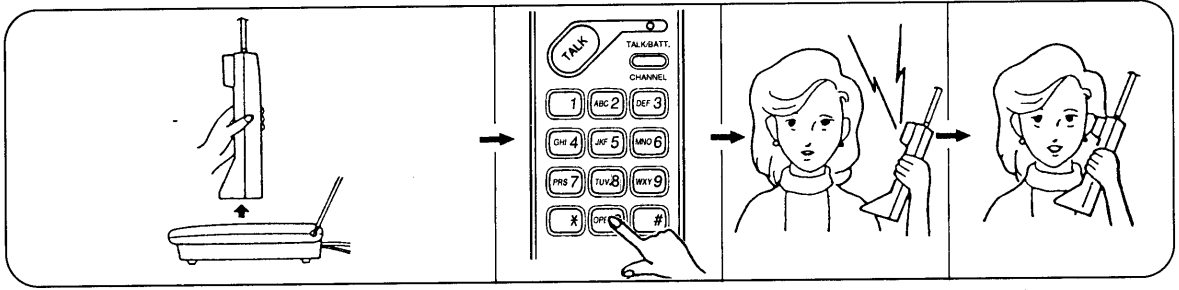

Lift the handset from the base unit, and press the TALK button. The TALK/BATT. LOW LED lights.

Dial the desired phone number by pressing the numbered buttons.

Wait for the phone you have called to begin ringing.

When the other party answers, you may begin speaking. To disconnect the call, return the handset to the base unit or press the TALK button.

Note

The telephone call is cut off when the A.C. power supply fails during a conversation, so immediately return the handset to the base unit.

- ① After talking on the handset during noisy circumstances, it may occur that the handset is not turned off even if you pressed the talk key, and it will continue to sound the error tone. In this case, relocate the handset on the battery charger or press the talk key again close to the base unit.
- ② During a call, do not pull out the battery in the handset. If you do so, the base unit is left to hold the line. But in case that the handset can not turn the line off due to the electric failure, make the standby mode by once pulling out the battery and then setting it in.

ANSWERING A CALL BY USING THE INSTANT TALK FUNCTION



Your phone will ring when someone is calling your number. Simply lift the handset from the base unit to answer the call; there's no need to press the TALK button.

Note

If the handset is already out of the base unit when the phone begins to ring, you will still have to press the TALK button to answer your call.

USING THE INSTANT STANDBY FUNCTION

When you have finished with a call, placing the handset back on the base unit automatically causes the handset to go into Standby mode, and hangs up the phone. There's no need to press the TALK button to hang up.

Note

If you don't place the handset back on the base unit, you will need to press the TALK button again to hang up the phone.

USING THE REDIAL/PAUSE BUTTON

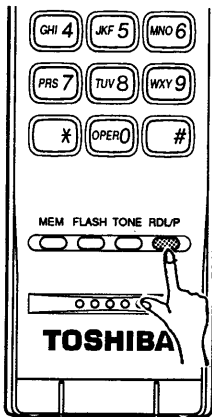

The REDIAL/PAUSE (RDL/P) button dials the last number (up to 32 digits) that you called. This feature is extremely useful when the number you called is busy.

To use this feature, simply press the RDL/P button **immediately** after selecting the talk mode. The last number called will then be dialed again.

Note

If any key is pressed before the RDL/P button, it will not redial. The RDL/P button must be pressed **immediately** after selecting the talk mode.

To use this button as a pause function please see page 18, "USING PAUSE FUNCTION".

USING THE FLASH BUTTON

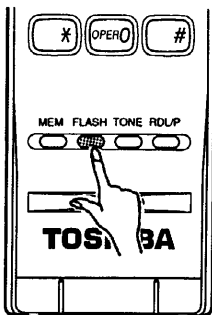

The FLASH button is used to send a timed hookflash on the telephone line for accessing services such as call waiting, etc. (Call Waiting is a telephone company service).

To use this feature, simply press the FLASH button while in the talk mode.

FLASH may also be used to obtain a new dial tone. Be careful not to press "FLASH" during normal conversation as this will cause your party to be cut off.

USING THE TONE BUTTON

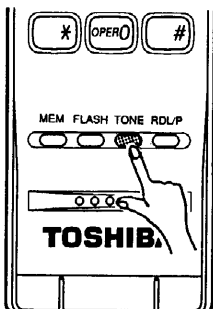

If you have rotary (Pulse) telephone service, the TONE button allows you to access a computer or computer-based services such as Sprint, MCI, etc., that respond to Tone signals only.

- ① Dial the local number to the computer or calling service with the TONE/PULSE switch in the P (pulse) position.
- ② After you have reached the number, press the TONE button and continue to dial your access code or any other numbers required.

SETTING THE DIGITAL SECURITY CODE

The Digital Security Code is automatically set when you charge the battery.

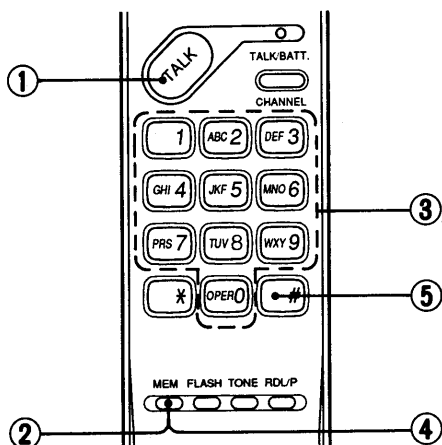

- ① If you wish to change the setting, make sure the handset is in the Standby mode.
- ② Press the MEM button.
- ③ Press any 5 digit number between 0 to 65535.
- ④ Press the MEM button again.
- ⑤ Press the # key. You will hear a long beep tone.
- ⑥ **Immediately place the handset in the base unit to complete the code change.** This procedure will change the code in the base unit and the handset. The code can be changed as often as desired.

Note

An error tone gives warning if you press any number other than 0 to 65535 (such as 66000).

THE BATTERY LOW LED

When the battery pack in the handset is very low and needs to be recharged, the TALK/BATT. LOW LED will blink on and off, and in addition the handset will sound a short beep every 3 seconds when in the talk mode. When this occurs, complete the call that you are making as rapidly as possible, and return the handset to the base unit for charging.

Note

You must recharge the handset for more than at least one minute to cancel the low battery condition warning tone.

USING THE CHANNEL SELECTOR BUTTON

Your FT-6003 selects the channel by pressing the CHANNEL button when interference noise is heard. The TALK/BATT. LOW LED keeps lighting while Talk mode.

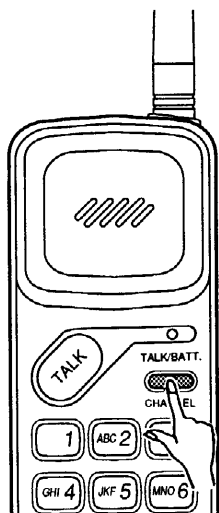

Note

When the channel selection is achieved, the **TALK/BATT. LOW** indicator turns off for about half second. If failed, error beep sounds and the channel is not changed.

USING THE PAGE BUTTON

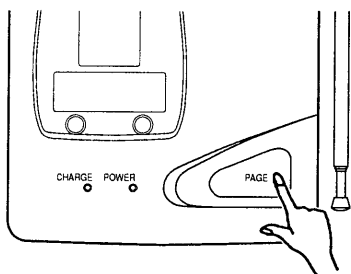

The Page function sends a signal from the base unit to the handset.

To use this feature, simply press the PAGE button on the base unit.

Note

The handset keeps beeping while pressing the PAGE button.

④ MEMORY DIALING

You can store up to 20 of your most frequently-called telephone numbers in memory by using the MEM button.

STORING NUMBERS

- ① Pick up the handset from the base unit. (**Do not press the TALK button.**)
- ② Press the MEM button.
- ③ Dial the desired telephone number.
- ④ Press the MEM button.
- ⑤ Select and press the numbers 01 to 20 for whichever number memory you wish to use.

If you have more telephone numbers to store in memory, repeat the steps from ② to ⑤.

- ⑥ Return the handset to the base unit.
- ⑦ Record the telephone numbers on the SPEED DIAL INDEX CARD which is located at the back of the handset.

EXAMPLE: MEM → 9 0 1 2 3 4 5 → MEM → 0 3

Notes

- Phone numbers of up to 16 digits (including a digit for a pause or a tone) can be stored.
- Be sure to listen for the tone or pulsing sound as you press each number. This will ensure that the number pressed has been properly entered into storage.
- When the number you have entered has been successfully stored, a long beep will be heard.
- If you make any mistakes, start from step ②.
- If you enter a number that exceeds 16 digits, warning tone will be heard.

STORING MIXED TONE/PULSE NUMBERS

Your FT-6003 can also store mixed mode numbers to make it easy to access long distance services. To store a mixed mode number.

- ① First make sure the TONE/PULSE switch rear of the base unit is in the PULSE mode.
- ② Press the MEM button (a short beep will be heard), and enter the numbers to be dialed in the PULSE mode.
- ③ Press the TONE button on the handset and enter the numbers to be dialed in the TONE mode.
- ④ When done entering numbers, press the MEM button, and the number of the memory to save the number in.

You will then hear a long beep when the number has been successfully stored. If you wish to enter a pause between any of the numbers in the dialing sequence (such as for switchboard delay etc.), press the RDL/P button at the point you wish to pause in the number sequence. Pressing the RDL/P button more than once will increase the amount of the delay.

EXAMPLE:

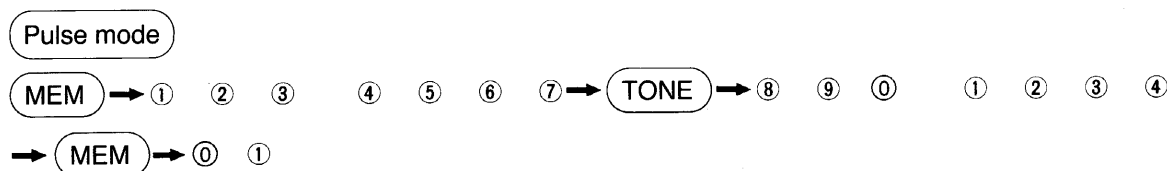

ERASING A STORED NUMBER

- ① Pick up the handset. (**Do not press the TALK button.**)
- ② Press the MEM button.
- ③ Press the MEM button.
- ④ Press the desired memory location 01 to 20.

EXAMPLE: MEM → MEM → ① ②

The telephone number stored in ① will be erased.

REPLACING A TELEPHONE NUMBER

Just store the new number following the same steps as in STORING. The new number will take the place of the old one.

DIALING A STORED NUMBER

To dial a number previously stored in memory,

- ① Pick up the handset and press the TALK button.
- ② Press the MEM button.
- ③ Press the memory number 01 to 20.

Your FT-6003 will then dial the previously stored number.

USING PAUSE FUNCTION

This RDL/P (REDIAL/PAUSE) button is very useful when making an outgoing call through a PBX and using long-distance services. Each time the RDL/P button is pressed, a pause of about four seconds will be inserted during the dialing sequence. If more than four seconds are needed, press the button twice.

Example: To store the number "0-1234567" in memory for a call through a PBX, follow these steps.



Pressing the RDL/P button or resetting the dial mode once is counted as one digit of the number.

USING CHAIN DIALING

This function is useful in dialing numbers longer than 16 digits.

For example a long distance number and a credit card number could be in 2 memory locations.

- Press the TALK button, MEM (MEMORY) button and a desired memory location (01 to 20) and then press MEM button and a desired memory location (01 to 20).

Example 1:  → MEM → 0 → 1 and then press MEM → 0 2

- MIXED DIAL OUT

Mixing memory dial and manual dialing are possible.

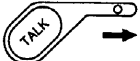
Example 2:  → MEM → 01 to 20 and then press 1 2 3 4 5 6 7

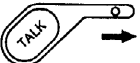
Example 3:  → 1 2 3 4 5 6 7 and then press MEM → 01 to 20

If necessary for further operating instruction, call 1-800-221-0314.

SPECIFICATIONS

HANDSET

Power Source	Customer Replaceable Ni-Cd Battery 270mAH 3.6V DC
Battery Life	3 weeks at Standby Mode, after proper initial charging cycle.
Dimensions (H/W/D)	Approx. 8" x 2-3/16" x 2-1/4" (203 x 55 x 57mm) Antenna Length 4-5/8" (117mm)
Weight	Approx. 11.3 oz (320g)

BASE UNIT

Power Source	AC 120V 60 Hz/DC 9V
Dimensions (H/W/D)	Approx. 1-9/16" x 4-5/8" x 8" (40 x 117 x 203mm)
Weight	Approx. 17 oz (480g)

SUPPLIED ACCESSORIES

Rechargeable Battery	(1) TRB-6500
AC Adaptor	(1) TAC-6500 or TAC-6500BK for FT-6003BK
Telephone Cord	(1)
Owner's Manual	(1)
Speed Dial Index	(1)
Wall Mount Screw	(2)

OPTIONAL ACCESSORY

Wall Mount Adaptor	(1) WMA-6000
--------------------	--------------

For purchase of Rechargeable Battery and Wall Mount Adaptor, please call **1-800-631-3811**.

TROUBLESHOOTING GUIDE

Should any problem occur with the set, make the following simple tests to determine whether or not servicing is required. If the problem persists after you have made these tests, call **1-800-631-3811** for Customer Service.

Problem	Cause
No dial tone	<ol style="list-style-type: none"> 1. AC adaptor of the base unit not plugged into 120 volt AC outlet. 2. Battery is low in power — place the handset in the base unit and recharge. 3. Telephone line cord detached — check wall jack. 4. TALK button in standby — switch to talk position. 5. Telephone line trouble — check line with a conventional phone.
No calls coming in	<ol style="list-style-type: none"> 1. All of the above except 4. 2. TALK button is in the talk position — switch to standby position.
Static noise on conversation	<ol style="list-style-type: none"> 1. Approaching maximum range of the base unit — make sure that the base antenna is fully extended. 2. Outside range of the base unit. 3. Battery is low — place the handset in the base unit and charge. 4. Base located in an area with high interference — relocate the base unit. 5. General interference from TV, appliances, etc. — move away from interference source.
Battery goes low too quickly.	Battery not fully charged on initial charge cycle. Battery must be charged for 12 to 16 hours without any interruption.

SERVICE REQUIREMENTS

If the cordless telephone should malfunction, all repairs will be performed by an authorized Toshiba Service Station. This unit has been registered within the FCC for direct connection to the telephone network. Under the FCC program, no customer is authorized to repair this unit. This applies to a unit both in and out of warranty. If an unauthorized repair is performed, the registration of the unit for direct connection to the network will be null and void. If the unit is still in warranty, the remainder of the warranty period will also be null and void.

It is the responsibility of users requiring service to report the need for service to their Toshiba dealer.

IMPORTANT INSTRUCTIONS TO USERS

Your FT-6003 has been designed and constructed to conform to federal regulations and can be connected to the phone line as described in this manual.

Please note that each product connected to the telephone line places a certain load on the line. We designate this as the unit's "Ringer Equivalence Number".

It is most unlikely, but . . . If your FT-6003 should cause problems on the phone line, the phone company has the right to temporarily discontinue your service. If this happens, the phone company will notify you and give you the opportunity to correct the problem. Also, you need to know that the phone company does have the right to make changes in their lines and/or equipment.

If these changes might affect your FT-6003 (or require changes in the FT-6003 or its connection), the phone company will notify you in writing, so you have the chance to take whatever action necessary to ensure uninterrupted phone service.

FCC REQUIREMENTS

You are no longer required by the FCC to notify your local telephone company of your intent to connect a new telephone. Your local telephone company may call you and request information about your phone such as: the brand name, model number, registration number, and ringer equivalence number. This information is provided on a label located at the bottom of the base unit and handset.

You may not directly connect your FT-6003 to coin telephone services. Check with your local telephone company if you wish to connect your FT-6003 to a party line service. Some party line services require a special adaptor or modification to your telephone.

TELEPHONE/TELEPHONE ANSWER MACHINE LIMITED WARRANTY

Toshiba America Consumer Products, Inc. ("TACP") and Toshiba Hawaii Inc. ("THI") make the following limited warranties. These limited warranties extend to the original consumer purchaser or any person receiving this set as a gift from the original consumer purchaser and to no other purchaser or transferee.

Limited One (1) Year Warranty

TACP and THI warrant this product and its parts against defects in materials or workmanship for a period of one year after the date of original retail purchase. During this period, TACP and THI will repair a defective product or part, without charge to you. You must deliver the entire set to an Authorized TACP/THI Factory Service Center. You pay for all transportation and insurance charges for the set to and from the Factory Service Center.

Limited One (1) Year Warranty of Parts

TACP and THI warrant the parts in this product against defects in materials or workmanship for a period of one year after the date of original retail purchase. During this period TACP and THI will replace a defective part without charge to you. You must also deliver the entire product to one of the Factory Service Centers listed below. You pay for all transportation and insurance charges for the product to and from the Factory Service Center.

Owner's Manual

You should read the owner's manual thoroughly before operating this product.

Your Responsibility

The above warranties are subject to the following conditions:

- (1) You must retain your bill of sale or provide other proof of purchase.
- (2) Contact one of the Factory Service Centers for warranty service within (30) days after you find a defective product or part. You can attain service by contacting one of the TACP/THI Factory Service Centers listed below.
- (3) You must notify a Factory Service Center within thirty (30) days after you discover a defective product or part.
- (4) All warranty servicing of this product must be made by a Factory Service Center TACP/THI Service Station.
- (5) These warranties are effective only if the product is purchased and operated in the U.S.A.
- (6) Warranties extend only to defects in materials or workmanship as limited above and do not extend to any product or parts which have been lost or discarded by you or to damage to products or parts caused by misuse, accident, improper installation, improper maintenance or use in violation of instructions furnished by us; or to units which have been altered or modified without authorization of TACP/THI or to damage to products or parts thereof which have had the serial number removed, altered, defaced or rendered illegible.

Step-By-Step Procedures — How To Obtain Warranty Service

IN THE CONTINENTAL UNITED STATES . . .

Should your unit require service or parts, CALL
Toll Free 1-800-631-3811



HAWAII

Toshiba Hawaii Inc.
Service Department
327 Kamakee Street
Honolulu, HI 96814
Phone Number:
(808) 521-5377

IN THE EVENT A PROBLEM SHOULD DEVELOP WITH YOUR PRODUCT, PLEASE PROCEED AS FOLLOWS:

- (1) Contact a TACP/THI Factory Service Center for warranty service within thirty (30) days after you find a defective product or part. You can find an Authorized TACP/THI Service Station by calling this toll free number 1-800-631-3811 or by contacting one of the TACP/THI Service Centers listed below.
- (2) Arrange for the delivery of the product to the Authorized TACP/THI Service Station Products shipped to the Service Station must be insured and safely and securely packed, preferably in the original shipping carton, and a letter

of explaining the defect and also a copy of the bill of sale or other proof of purchase must be enclosed. All transportation and insurance charges must be prepaid by you.

- (3) If you have any question about service, please contact one of the following TACP/THI Service Centers:

EAST

82 Totowa Road
Wayne, NJ 07470
Phone Number:
(201) 628-8000

SOUTHEAST

490 Armour Circle, N.E.
Atlanta, GA 30324
Phone Number:
(404) 872-6955

MIDWEST

1010 Johnson Drive
Buffalo Grove, IL 60089
Phone Number:
(708) 541-9400

SOUTHWEST

1421 Champion Drive
Suite 304
Carrollton, TX 75006
Phone Number:
(214) 243-1367

WEST

5490A East Francis St
Ontario, CA 91761
Phone Number:
(909) 998-5303

IMPORTANT: PACKING AND SHIPPING INSTRUCTIONS

When you send the product to a service center, you should use the original carton box and packing material, then insert the original carton box containing the unit into another carton, using more packing material.

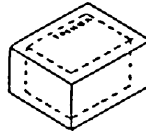

ALL WARRANTIES IMPLIED BY STATE LAW, INCLUDING THE IMPLIED WARRANTIES OF MERCHANTABILITY AND FITNESS FOR A PARTICULAR PURPOSE, ARE EXPRESSLY LIMITED TO THE DURATION OF THE LIMITED WARRANTIES SET FORTH ABOVE. Some states do not allow limitations on how long an implied warranty lasts, so the above limitation may not apply to you. **WITH THE EXCEPTION OF ANY WARRANTIES IMPLIED BY STATE LAW AS HEREBY LIMITED, THE FOREGOING EXPRESS WARRANTY IS EXCLUSIVE AND IN LIEU OF ALL OTHER WARRANTIES, GUARANTEES, AGREEMENTS AND SIMILAR OBLIGATIONS OF MANUFACTURER OR SELLER WITH RESPECT TO THE REPAIR OR REPLACEMENT OF ANY PRODUCT OR PARTS.**

IN NO EVENT SHALL TACP OR THI BE LIABLE FOR CONSEQUENTIAL OR INCIDENTAL DAMAGES. Some states do not allow the exclusion or limitation of incidental or consequential damages so the above limitation may not apply to you.

No person, agent, distributor, dealer, service station or company is authorized to change, modify or extend the terms of these warranties in any manner whatsoever. The time within which an action must be commenced to enforce any obligation of TACP and THI arising under this warranty or under any statute, or law of the United States or any state thereof, is hereby limited to one year from the date you discover or should have discovered, the defect. This limitation does not apply to implied warranties arising under state law. Some states do not permit limitation of the time within which you may bring an action beyond the limits provided by state law so the above provision may not apply to you.

This warranty gives you specific legal rights and you may also have other rights which vary from state to state.



IMPORTANT

We suggest you record the following information and retain for your records along with your bill of sale or equivalent document.

Model no. _____ **Serial no.** _____
Purchase date _____ **Dealer** _____
Dealer address _____

© 1993 TOSHIBA AMERICA CONSUMER PRODUCTS, INC.