

QUICK REFERENCE

The section provides a general outline of operational procedures.

Loading Batteries (page E-41)

* Be sure to use the AC adapter/charger to charge the battery before using it.

1

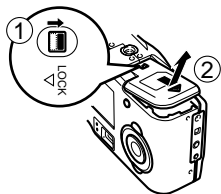

On the bottom of the camera, slide the battery compartment cover lock towards the front of the camera (①) to release the cover.

Grasping both sides of the battery compartment cover, swing it open (②).

2

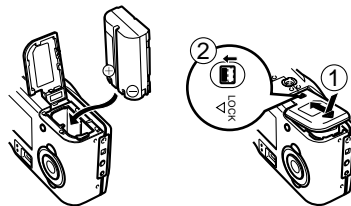

Load batteries so their plus (+) and minus (-) ends are facing as shown in the illustration.

Close the battery compartment cover (①), and then slide the battery compartment cover lock towards the back of the camera to lock the cover in place (②).

QUICK REFERENCE

Loading a Memory Card (page E-36)

* Loaded in the camera when you purchase.

1

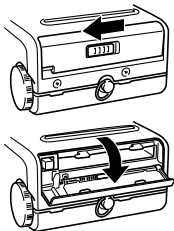

Open the memory card slot cover.

2

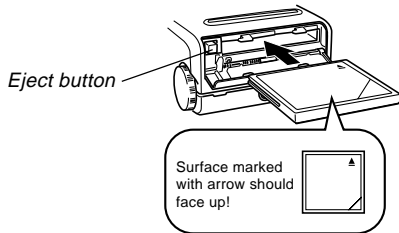

Insert a memory card into the camera so the arrow on the front of the card is pointed up.

- If the memory card eject button is extended, press it back down before inserting the memory card.

3

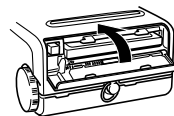

Close the memory card slot cover.

QUICK REFERENCE

Setting the Current Date and Time (page E-48)

- Be sure to use the procedure on page E-48 to set the time and date before using the camera for the first time.
- Failure to set the date and time correctly will cause the wrong names to be assigned to data files and improper operation of the camera's date and time stamp feature. Be sure that you set the correct date and time before using the camera.

QUICK REFERENCE

Recording Images (page E-50)

3

After confirming that the Auto Focus operation is complete (the operation lamp lights green), press the shutter button.

2

After composing the image on the monitor screen, press the shutter button about half way and hold it there.

- The monitor screen image may become dim when you press the shutter button half way.
- The camera's Auto Focus feature automatically focuses the image.

1

Pressing down the Power/Function switch, slide it to REC.

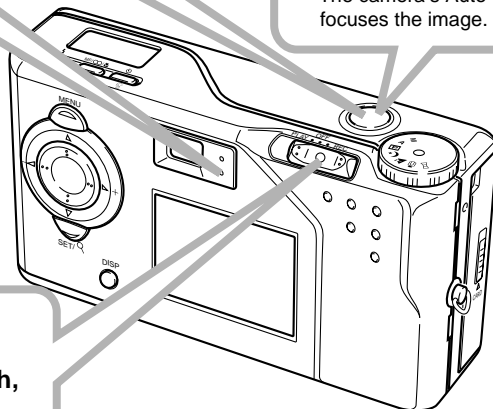

QUICK REFERENCE

Playing Back Images (page E-83)

2

Use [▶] and [◀] to scroll through the images stored in camera memory.

1

Pressing down the Power/Function switch, slide it to **PLAY**.

- This turns on power and displays recorded images on the monitor screen.

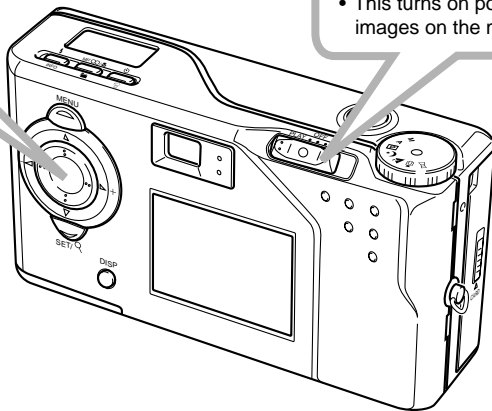

QUICK REFERENCE

Deleting Images (page E-96)

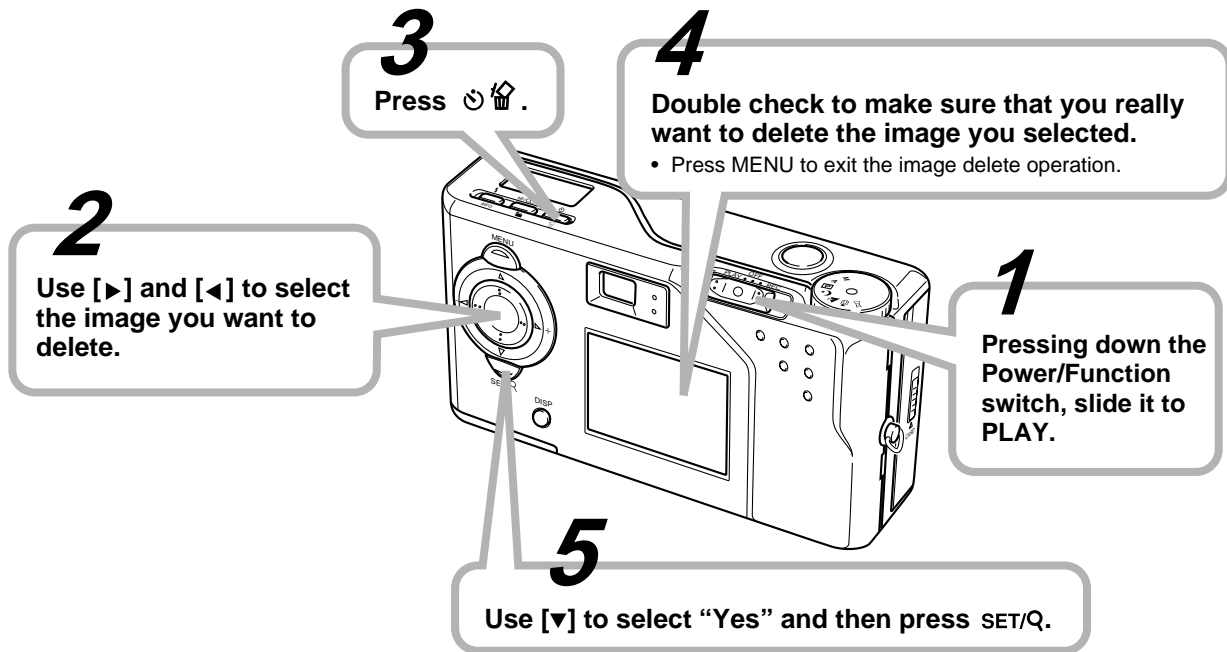

CONTENTS

INTRODUCTION

Congratulations upon your selection of the QV-3EX LCD Digital Camera.

To get the most out of the QV-3EX, be sure to carefully read this manual and follow the instructions contained in it.

E-2 QUICK REFERENCE

E-11 FEATURES

E-16 PRECAUTIONS

E-21 UNPACKING

Attaching the Strap E-23

Using the Soft Case E-24

E-25 GENERAL GUIDE

Lens E-25

Top and Display E-26

Side E-27

Bottom E-27

Dial E-28

E-31 MONITOR SCREEN

REC Mode E-31

Indicator display E-33

PLAY Mode E-34

Menu Screens E-34

E-36 MEMORY CARDS

Inserting a Memory Card into the Camera E-36

Removing a Memory Card from the Camera E-37

Formatting a Memory Card E-38

E-41 POWER SUPPLY

Loading the Battery E-41

Using AC Power E-45

Power Save Settings E-46

E-48 SETTING THE CURRENT DATE AND TIME

Setting the Date and Time E-48

Selecting the Date Format E-49

E-50 RECORDING

Turning Camera Power On and Off E-50

Using the Shutter Button E-50

Recording a Single Snapshot Image E-51

Recording Images under Low Battery Power E-54

Using the Viewfinder for Recording E-54

Using Focus Lock E-55

Using the Flash E-56

Quality Settings E-58

Exposure Compensation E-59

E-61 OTHER RECORDING FUNCTIONS

Using the Continuous Shutter Mode E-61

Using the AEB

(Automatic Exposure Bracketing) Mode E-62

Using Digital Zoom E-63

Manual Focus E-64

Infinity Mode Recording E-65

Using the Macro Mode	E-65
Movie Recording	E-66
Panorama Recording	E-68
Night Scene Mode	E-69
Landscape Mode Recording	E-70
Aperture Priority Image Recording	E-71
Manual Exposure Recording	E-72
Monochrome and Sepia Recording	E-73
Using the Self-timer	E-74
Performing Manual White Balance	E-75
Specifying Power On Defaults	E-76
Using the REC Menu	E-79

E-83 PLAYBACK

Basic Playback Operation	E-83
Playing Back a Movie	E-84
Panorama Playback	E-85
Zoom the Playback Image	E-86
Displaying Other Image Information	E-87
Displaying Nine Images	E-88
Slide Show	E-89
Using the PLAY Menu	E-90

E-92 FOLDER TYPES

Memory Card Folder Precautions	E-92
Selecting a Folder for Playback	E-93

E-94 IMAGE PROTECTION

Protecting and Unprotecting a Single Image	E-94
Protecting Folders	E-95
Protecting and Unprotecting All Images on a Memory Card ...	E-95

E-96 DELETING IMAGES

Deleting the Currently Selected Image	E-96
Deleting a Single Image	E-97
Deleting All the Images in a Folder	E-98
Deleting All Unprotected Images	E-99

E-100 DPOF

Printing Specific Images	E-100
Printing All the Images in a Folder	E-101
Printing All Images	E-102

E-103 CONNECTIONS**E-104 CONNECTING TO OTHER EQUIPMENT**

Connecting to a Television	E-104
Connecting to a Computer	E-105

E-108 USING CompactFlash CARDS WITH YOUR COMPUTER

Setting Up to Access CompactFlash Card Contents From Your Computer	E-108
Memory Card Data	E-109
Card Browser	E-111

E-115 TROUBLESHOOTING

E-119 MESSAGES

E-121 SPECIFICATIONS

- CASIO COMPUTER CO., LTD. assumes no responsibility for any damage or loss resulting from the use of this manual.
- CASIO COMPUTER CO., LTD. assumes no responsibility for any loss or claims by third parties which may arise through the use of the QV-3EX.
- CASIO COMPUTER CO., LTD. assumes no responsibility for any damage or loss caused by deletion of data as a result of malfunction, repairs, or battery replacement. Be sure to back up all important data on other media to protect against its loss.
- *Windows and Internet Explorer are registered trademarks of Microsoft Corporation.*
- *Macintosh is a registered trademark of Apple Computer, Inc.*
- *CompactFlash™ and  logo are registered trademarks of SanDisk Corporation.*
- *Other company, product and service names used herein may also be trademarks or service marks of others.*
- *The USB driver uses software by Phoenix Technologies Ltd.*
Compatibility Software Copyright © 1997
Phoenix Technologies Ltd., All Rights Reserved.
- *IBM is a registered trademarks of International Business Machines Corporation.*

FEATURES

Continuous recording (page E-61)

Continuous recording of high-quality images at 1-second intervals (when the monitor screen is turned off) is just like have a motor drive on the camera.

DCF Data Storage (page E-109)

DCF (Design rule for Camera File system) data storage protocol provides image inter-compatibility between the digital camera and printers.

Digital Print Order Format (DPOF) (page E-100)

Images can be easily printed in the sequence you want using a DPOF compatible printer. DPOF can also be used by professional print services when specifying images to produce prints.

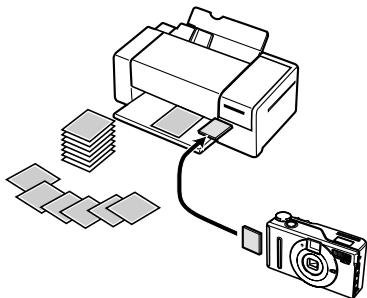

Simple image management (page E-111)

Images are stored on a large-capacity CompactFlash memory card. A new Card Browser feature produces thumbnails of all images on a card quickly and easily.

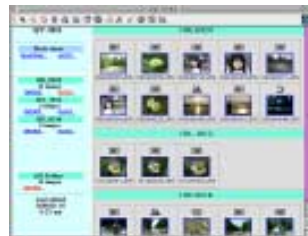

FEATURES

Movie and panorama images (pages E-84, 85)

A buffer lets you capture images of events that occurred before you pressed the shutter button.

A built-in function lets you combine up to nine images into breathtaking panoramas.

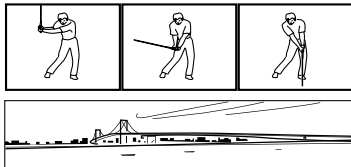

Easy-to-understand graphic interface (page E-31)

All camera operations can be performed on graphic based interactive menu screens. A CASIO high-resolution HAST LCD makes screen images clearer and more colorful than ever before.

CASIO original metering system

Light metering includes innovative multi-pattern metering.

3.34-Megapixel CCD

Images are recorded by a 3.34-megapixel CCD for amazing resolution and clarity.

Some slight image noise may be caused when using slow shutter speeds.

Easy connection to other devices (page E-103)

USB, DIGITAL, and VIDEO OUT terminals provide easy connection to other devices.

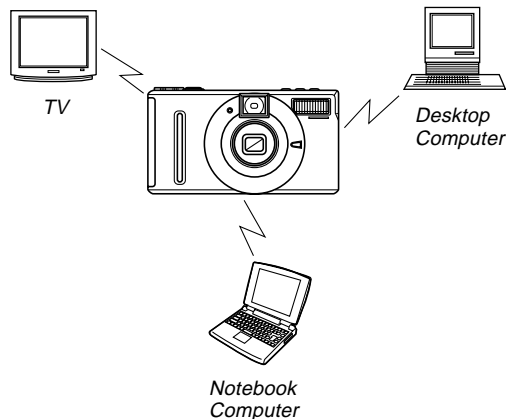

12-step Digital Zoom Recording

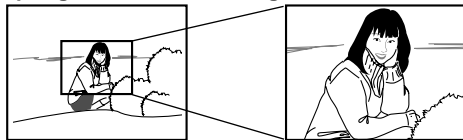

page E-63

Manual Mode

Manually set the shutter speed and aperture to suit the type of image you are recording.



page E-72

Landscape Mode with built-in color filter

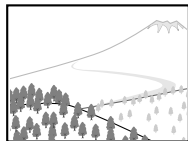

page E-70

Aperture Priority Auto Mode

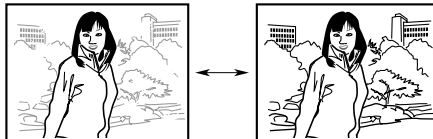

page E-71

Night Scene



page E-69

AEB Mode



page E-62

FEATURES

Macro Feature

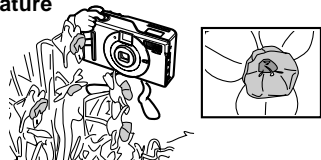

page E-65

Histogram

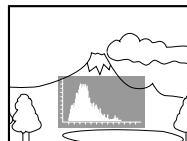

page E-32,87

Self-timer



page E-74

Display Zoom

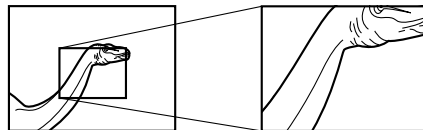

page E-86

Date and Time Stamping



page E-48

9-image Screen



page E-88

Slide Show



page E-89

Image Protection



page E-94

PRECAUTIONS

General Precautions

Be sure to observe the following important precautions whenever using the QV-3EX.

All references in this manual to “this camera” and “the camera” refer to the CASIO QV-3EX Digital Camera.

- Never try to take pictures or use the built-in display while operating a motor vehicle or while walking. Doing so creates the danger of serious accident.
- Never try to open the case of the camera or attempt your own repairs. High-voltage internal components create the risk of electrical shock when exposed. Always leave maintenance and repair work up to authorized CASIO service providers.
- Never fire the flash in the direction of a person operating a motor vehicle. Doing so can interfere with the driver's vision and create the danger of accident.
- Never fire the flash while it is too close to the subject's eyes. Intense light from the flash can cause eye damage if it is fired too close to the eyes, especially with young children. When using the flash, the camera should be at least one meter from the eyes of the subject.
- Keep the camera away from water and other liquids, and never let it get wet. Moisture creates the danger of fire and electrical shock. Never use the camera outdoors in the rain or snow, at the seashore or beach, in the bathroom, etc.
- Should foreign matter or water ever get into the camera, immediately turn power off, unplug the AC adapter from the power outlet, and contact your dealer or nearest CASIO service provider. Using the camera under these conditions creates the danger of fire and electrical shock.
- Should you ever notice smoke or a strange odor coming out of the camera, immediately turn power off and unplug the AC adapter from the power outlet. Using the camera under these conditions creates the danger of fire and electrical shock. After making sure there is no more smoke coming from the camera, take it to your nearest CASIO service provider for repair. Never attempt your own maintenance.
- At least once a year, unplug the AC adapter from the power outlet and clean the area around the prongs of the plug. Dust build up around the prongs can create the danger of fire.
- If the camera's case should ever become cracked due to dropping it or otherwise subjecting it to rough treatment, immediately turn power off, unplug the AC adapter from the power outlet, and contact your nearest CASIO service provider.
- Never use the camera inside of an air craft or in any other areas where its use is prohibited. Doing so can result in an accident.

- Physical damage and malfunction of this camera can cause the image data stored in its memory to be deleted. Be sure to always keep backup copies of data by transferring them to personal computer memory.
- Never open the battery compartment cover, disconnect the AC adapter from the camera or unplug it from the wall socket while recording images. Doing so will not only make storage of the current image impossible, it can also corrupt other image data already stored in camera memory.

Operating conditions

- This camera is designed for use in temperatures ranging from 0°C to 40°C.
- Do not use or keep the camera in the following areas.
 - In areas subject to direct sunlight
 - In areas subject to high humidity or dust
 - Near air conditioners, heaters, or other areas subject to temperature extremes
 - Inside of a closed vehicle, especially one parked in the sun
 - In areas subject to strong vibration

Condensation

- When you bring the camera indoors on a cold day or otherwise expose it to a sudden change of temperature, there is the possibility that condensation can form on the exterior or on interior components. Condensation can cause malfunction of the camera, so you should avoid exposing it to conditions that might cause condensation.
- To keep condensation from forming, place the camera into a plastic bag before moving it into a location that is much warmer or colder than your current location. Leave it in the plastic bag until the air inside the bag has a chance to reach the same temperature as the new location. If condensation does form, remove the batteries from the camera and leave the battery compartment cover open for a few hours.

About the camera's backlight...

- The camera is equipped with a fluorescent light source to provide the back lighting for its LCD.
- The normal service life of the backlight is approximately six years, when the camera is used for about two hours a day.
- Should the LCD image appear abnormally dark, take the camera to your dealer or an authorized CASIO service provider to have the light source replaced. Note that you will be charged for this replacement.
- Under very cold conditions, the backlight may require more time than normal to light, or reddish bands may appear in the displayed image. These conditions do not indicate malfunction, and normal operation should return at higher temperatures.

Monitor Screen

Recording

- The image shown on the monitor screen during recording is intended for composition purposes only, so its quality does not match that of the image as it is recorded. The image is recorded in accordance with the quality setting made with the procedure under “Quality Settings” on page E-58.
- A dimly lit subject can slow down monitor screen refresh or cause static in the displayed image.

Playback

This camera is designed for high-speed scrolling of images during playback. Because of this, the playback image that initially appears on the monitor screen does not show the full resolution of the image as recorded. When you stop at the image you want, the monitor screen refreshes and shows the image in its full resolution.

Lens

- Camera performance can be adversely affected by fingerprints or dirt on the lens surface. Never touch the lens surface with your fingers.
- Should the lens become dirty, use a blower to blow off dirt and dust, or a soft, dry cloth to wipe off the lens.
- This camera uses a telescoping type lens, which moves whenever the camera is turned on or off. Make sure nothing is blocking lens movement and never turn power on or off while the camera is laying lens down.
- Never remove batteries or disconnect the AC adapter while the lens is extended. Doing so can cause the lens to become stuck in the extended position, resulting in camera malfunction.

Date Setting

No date setting is made before the camera is shipped from the factory. Be sure to use the procedure on page E-48 to set the time and date before using the camera for the first time. File name assignment and date and time stamping will not be performed correctly if the time and date are wrong.

PRECAUTIONS

GUIDELINES LAID DOWN BY FCC RULES FOR USE OF THIS UNIT IN THE U.S.A. (not applicable to other areas).

This device complies with Part 15 of the FCC Rules. Operation is subject to the following two conditions: (1) this device may not cause harmful interference, and (2) this device must accept any interference received, including interference that may cause undesired operation.

NOTICE

This equipment has been tested and found to comply with the limits for a Class B peripheral, pursuant to Part 15 of the FCC Rules. These limits are designed to provide reasonable protection against harmful interference in a residential installation. This equipment generates, uses and can radiate radio frequency energy and, if not installed and used in accordance with the instructions, may cause harmful interference to radio communications. However, there is no guarantee that interference will not occur in a particular installation. If this equipment does cause harmful interference to radio or television reception, which can be determined by turning the equipment off and on, the user is encouraged to try to correct the interference by one or more of the following measures:

- Reorient or relocate the receiving antenna.
- Increase the separation between the equipment and receiver.
- Connect the equipment into an outlet on a circuit different from that to which the receiver is connected.
- Consult the dealer or an experienced radio/TV technician for help.

FCC WARNING

Changes or modifications not expressly approved by the party responsible for compliance could void the user's authority to operate the equipment.

Properly shielded cables with ferrite core must be used for connection to host computer and/or peripherals in order to meet FCC emission limits.

THE SPECIAL VIDEO CABLE THAT COMES WITH THE CAMERA
---- THE CAMERA TO A VIDEO IN TERMINAL OF A COMPUTER
THE SPECIAL CONNECTION CABLE THAT COMES WITH QV-Link SOFTWARE
---- THE CAMERA TO A PROPER TERMINAL OF A COMPUTER

Declaration of Conformity

Model Number: QV-3EX
Trade Name: CASIO COMPUTER CO.,LTD.
Responsible party: CASIO INC.
Address: 570 MT. PLEASANT AVENUE,
DOVER,NEW JERSEY 07801
Telephone number: 973-361-5400

This device complies with Part 15 of the FCC Rules.
Operation is subject to the following two conditions:
(1) This device may not cause harmful interference, and
(2) this device must accept any interference received, including interference that may cause undesired operation.

CASIO COMPUTER CO.,LTD. QV-3EX



Tested To Comply
With FCC Standards

FOR HOME OR OFFICE USE

UNPACKING

Check to make sure that all of the items shown below are included with your camera. If something is missing, contact your dealer as soon as possible.

Camera



Soft case



Strap

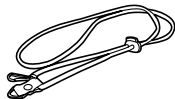

CD-ROM



Memory card (8 MB CompactFlash card)

Loaded in the camera when you purchase it.



Data Transfer Cable

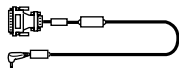

Special USB cable



Video cable



UNPACKING

AC Adapter/Charger (BC-7LA)

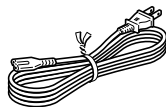

• AC power cord



• DC cord

• The shape of the AC power cord plug varies according to country or geographic area.

Lithium Ion Rechargeable Battery (NP-L7)

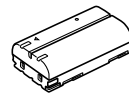

Manual

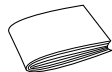

• User's Guide



• Lithium Ion Rechargeable Battery
User's Guide



• AC Adapter/Charger User's Guide

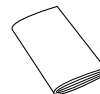

• Bundled Software User's Manual

Attaching the Strap

Pass the strap through the ring on the side of the camera as shown in the illustration.

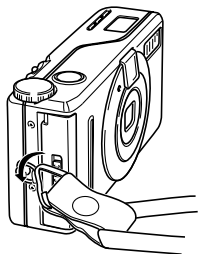

Adjusting the Length of the Strap

Slide the stopper to adjust the length of the strap. This way you can make it a short hand strap, or a longer shoulder or neck strap.

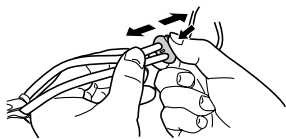

Using the Strap

Around your neck

Slide the stopper to adjust the length of the strap.

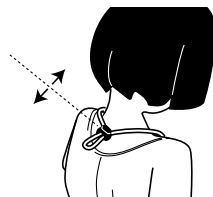

Around your wrist

Slide the stopper to adjust the length of the strap.

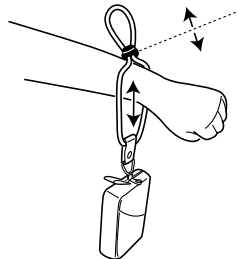

On your belt

Use your hook to attach the strap to your belt, etc.
Slide the stopper to adjust the length of the strap.

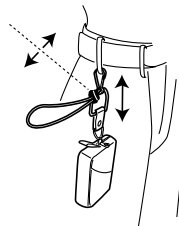

UNPACKING

▶▶ IMPORTANT! ◀◀

- Be sure to keep the strap around your wrist whenever using the camera to protect against accidentally dropping it.
- The supplied strap is intended for use with this camera only. Do not use for any other application.
- Never swing the camera around by the strap.
- Carrying the camera so it is swinging freely from the strap can cause it to become damaged by bumping against other objects. It also creates the danger of the camera becoming caught in a door or on other objects, resulting in personal injury.

Using the Soft Case

Keep the camera in its soft case to protect it when not in use.

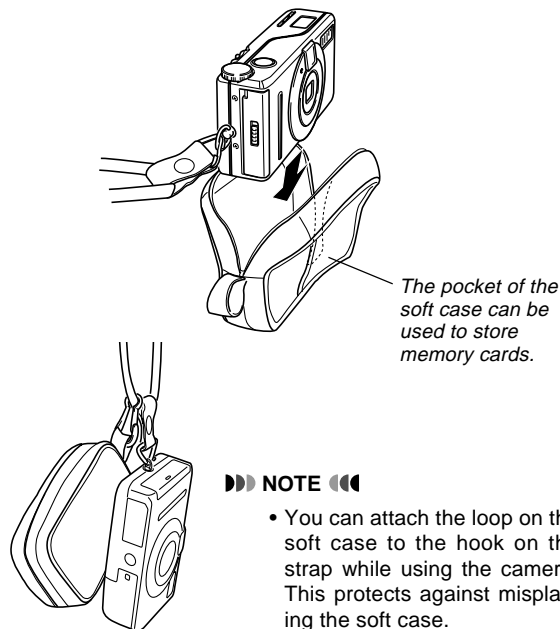

GENERAL GUIDE

The following illustrations show the names of each component, button and switch on the camera.

Lens

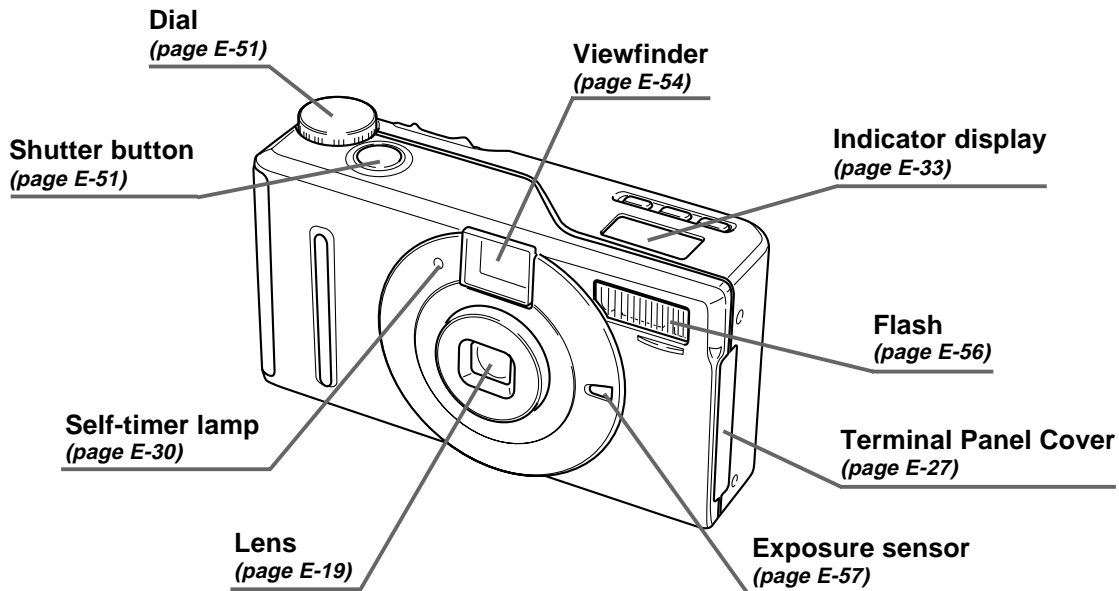

Top and Display

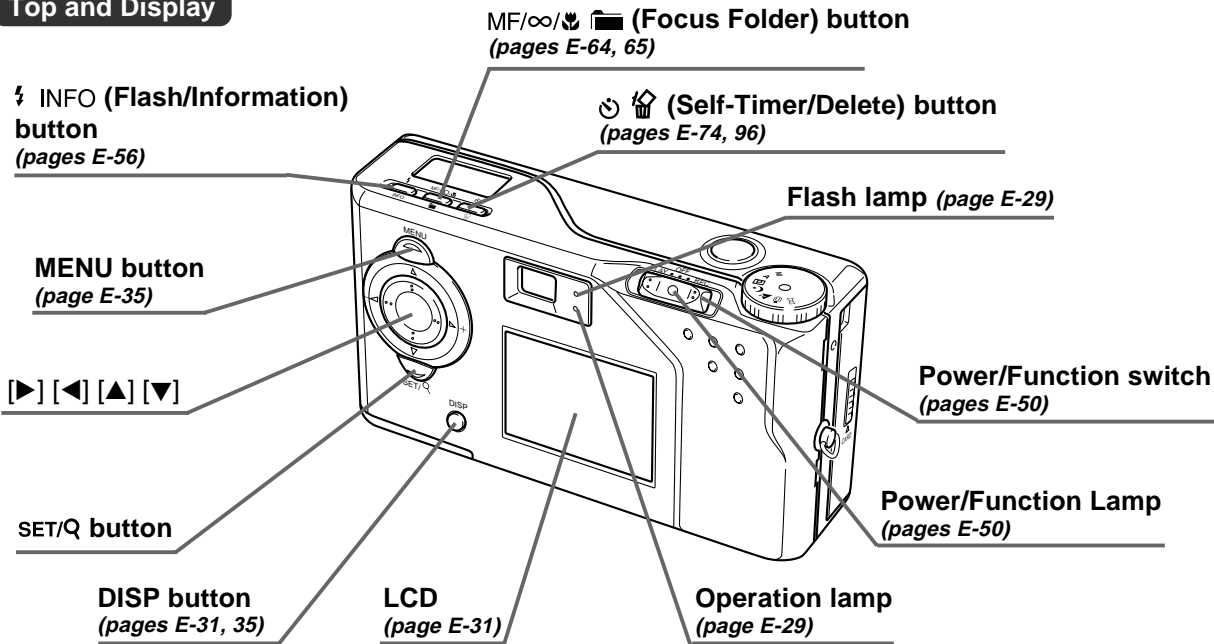

Side

DIGITAL terminal
(page E-103)

VIDEO OUT terminal
(page E-103)

USB port
(page E-103)

AC power terminal
(page E-45)

Memory card cover release
(page E-36)

Memory card slot cover
(page E-36)

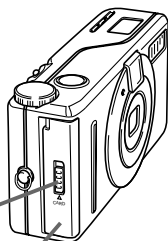
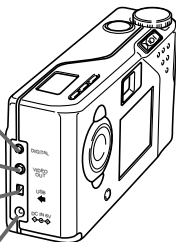
**Bottom**

Tripod screw hole

Battery compartment lock
(page E-41)



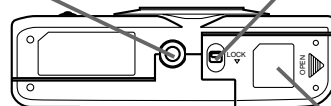
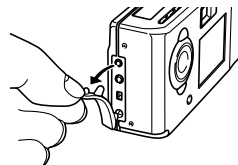

Battery compartment cover
(page E-41)

**Opening the Terminal Panel Cover**

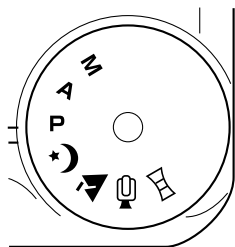
* Always keep the terminal panel cover in place whenever you are not using the terminals. When the cover is removed, keep it out of the reach of small children (who may accidentally swallow it), and take care that you do not lose it.

Dial



- M** Manual Mode (page E-72)
- A** Aperture Priority Auto Mode (page E-71)
- P** Program AE Mode (page E-50)
-  Night Scene Mode (page E-69)
-  Landscape Mode (page E-70)
-  Movie Mode (page E-66)
-  Panorama Mode (page E-68)

Power/Function lamp

This lamp lights or flashes to indicate the status of the operation you are performing, as described below.

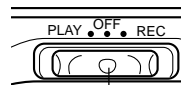

Power/Function lamp

REC Mode

Lamp Color	On	Flashing
Green	Power is on.	Camera is starting up / A memory card write operation is being performed
Red	–	Camera is powering down.

PLAY Mode

Lamp Color	On	Flashing
Green	Power is on.	Camera is starting up.
Red	–	Camera is powering down.

Operation lamp

This lamp lights or flashes to indicate the status of the operation you are performing, as described below.

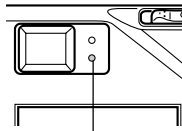

Operation lamp

REC Mode

Lamp Color	Flashing
Green	Camera is standing by for movie recording (Past) / Self-timer is counting down / Low battery warning / Card browser is being created

Shutter Button Pressed Half Way

Lamp Color	On
Green	Auto focus operation is complete.
Red	Auto focus operation failed.

PLAY Mode

Lamp Color	Flashing
Green	Delete operation is in progress / Format operation is in progress / Low battery warning / Card browser is being created
Red	Memory card abnormality

▶▶ IMPORTANT! ◀◀

- Never open the memory card cover while the Power/Function lamp or Operation lamp is flashing. Doing so will result in loss of the images you have just recorded.

Flash lamp

This lamp lights or flashes to indicate the status of the operation you are performing, as described below.

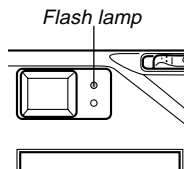

REC Mode

Lamp Color	Flashing
Amber	Flash is charging / Low battery warning

Partial Shutter Button

Lamp Color	On
Amber	Ready to fire.

- When the Operation lamp and Flash lamp are both flashing, an error message appears on the monitor screen, regardless of whether the monitor screen is turned on or off.

Self-timer lamp

This lamp flashes when the self-timer is performing a timer operation prior to releasing the shutter.

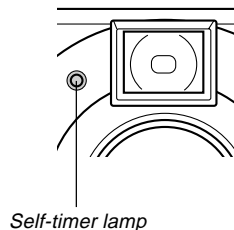

MONITORBILDSCHIRM

Die Funktion der DISP-Taste hängt von dem Modus ab, in dem Sie sich gerade befinden.

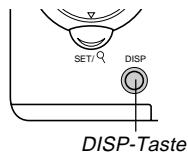

- REC-Modus: Mit jedem Drücken der DISP-Taste wird zyklisch durch die Displayfunktionen geschaltet, wie es nachfolgend dargestellt ist.

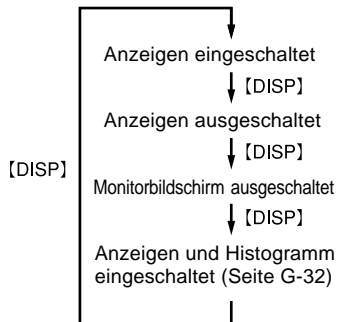

- PLAY-Modus: Mit jedem Drücken der DISP-Taste werden die Anzeigeindikatoren (Seite G-34) ein- oder ausgeschaltet.

REC-Modus (Aufnahmemodus)

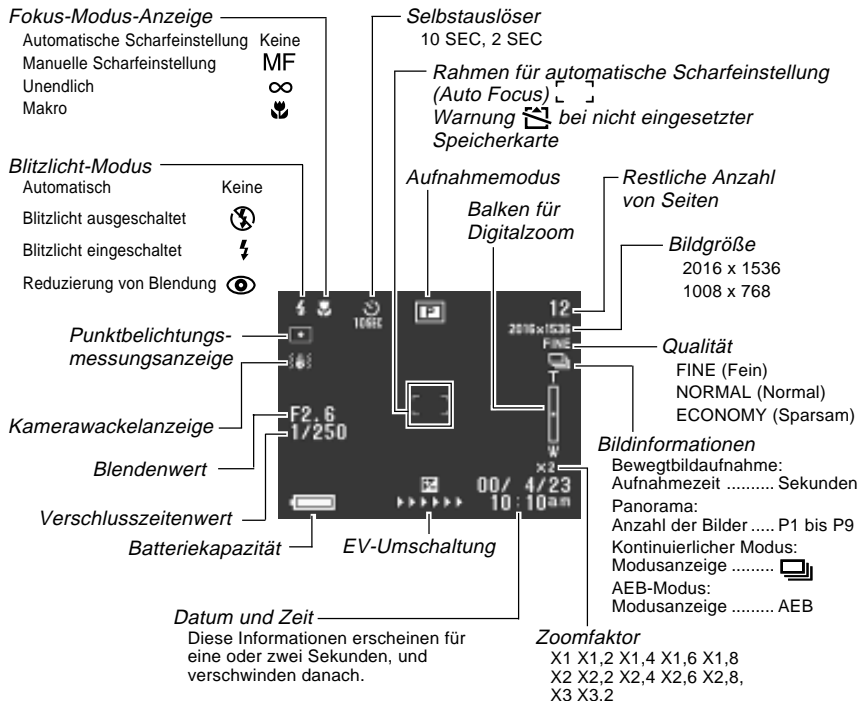

Histogrammanzeige

Bei der Aufnahme von Standbildern können Sie ein Histogramm am Monitorbildschirm anzeigen, um die Belichtungspegel zu überwachen.



Das Histogramm ist eine Grafik der Helligkeitspegel der Pixel in Abhängigkeit von der Anzahl der Pixel. Die vertikale Achse stellt die Anzahl der Pixel dar, wogegen die horizontale Achse der Helligkeit entspricht. Die Informationen des Histogramms können für die Berichtigung oder das Editieren eines Bildes verwendet werden, um zu bestimmen, ob die Bilddetails genug Schatten (linke Seite), mittlere Helligkeitspegel (Mitte) oder hohe Helligkeitspegel (rechte Seite) enthalten.

Falls ein Histogramm ein Muster zeigt, das zu sehr nach einer Seite neigt, dann können Sie die Belichtungskompensation einstellen (Seite G-59) oder den Modus mit automatischer Blendenpriorität (A-Modus) verwenden und die Blende einstellen (Seite G-71), oder den manuellen Modus (M-Modus) verwenden, um die Verschlusszeit und die Priorität einzustellen.

»» WICHTIG! ««

- Die von dem Histogramm angezeigten Belichtungsbedingungen sind vielleicht nicht genau, wenn Sie das Blitzlicht oder die Multi-Belichtungsmessung verwenden bzw. unter bestimmten anderen Bedingungen.
- Im Falle der kontinuierlichen Aufnahme (Seite G-61) wird das Histogramm nur für das erste Bild angezeigt.
- Das Histogramm wird während einer Bewegtbildaufnahme (Seite G-66) nicht angezeigt.

Anzeige bei halb gedrücktem Verschlussauslöseknopf

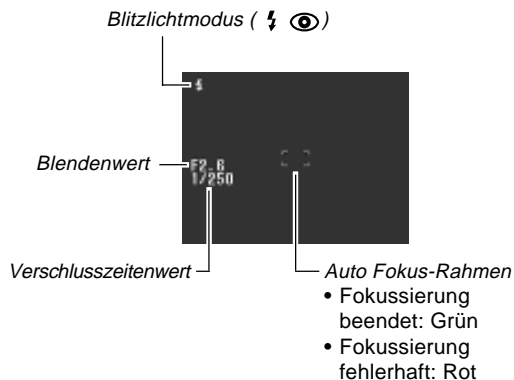

- Die Blitzlichtanzeige zeigt an, dass das Blitzlicht gezündet wird (wenn die Blitzlichtautomatik gewählt ist).

» WICHTIG! «

- Ein falsche eingestellter Wert für Blende oder Verschlusszeit führt dazu, dass der entsprechende Wert am Monitorbildschirm Orange erscheint.

Anzeigedisplay

Das an der Oberseite der Kamera angeordnete Anzeigedisplay zeigt während der Aufnahme von Bildern die verschiedenen Statusanzeigen der Kamera an. Das Anzeigedisplay ist besonders dann nützlich, wenn der Monitorbildschirm ausgeschaltet ist.

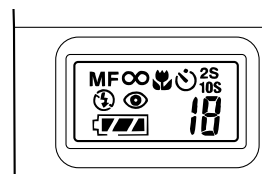

MF	Indikator für manuellen Scharfeinstellmodus		Batteriekapazität
∞	Indikator für unendlich		Indikator für Makro-Modus
	Indikator für ausgeschaltetes Blitzlicht	2S 10S	Selbstauslöser-Zeiteinstellung
	Indikator für Blendungsreduzierung (Vermeidung von roten Augen)	Nummer	Verbleibende Anzahl der Bilder/Bildnummer

PLAY-Modus (Wiedergabemodus)

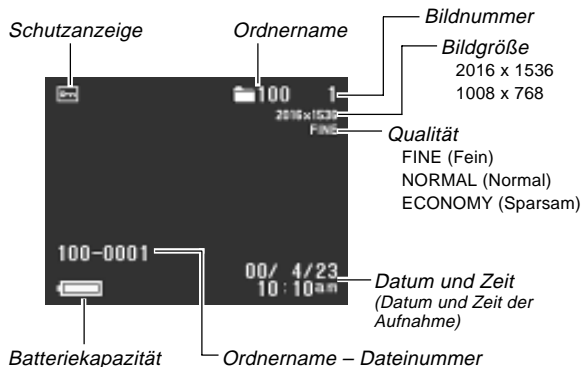

Die obigen Anzeigen erscheinen nur dann, wenn das Anzeigendisplay mit der DISP-Taste eingeschaltet wurde.

Änderung der Anzeigesprache

Verwenden Sie den folgenden Vorgang, um die Anzeigesprache zwischen Englisch und Japanisch umzuschalten.

1. Die MENU-Taste drücken.
2. Wählen Sie "SET UP" → "Language".
3. Wählen Sie die gewünschte Sprache.

Menübildschirme

Drücken Sie die MENU-Taste, um die Menüanzeige zu erhalten. Der Inhalt der Menüanzeige hängt davon ab, ob Sie den PLAY- oder REC-Modus aktiviert haben. Während die Menüanzeige in dem REC-Modus am Display angezeigt wird, drücken Sie die DISP-Taste, um zwischen dem grundlegenden Menü und dem weiterführenden Menü umzuschalten. In dieser Bedienungsanleitung wird immer das grundlegende Menü für Posten verwendet, die sowohl im grundlegenden Menü als auch im weiterführenden Menü erscheinen.

In dem REC-Modus zeigt das grundlegende Menü die für die grundlegenden Funktionen erforderlichen Einstellungen an, wogegen das weiterführende Menü die Einstellungen für alle Funktionen einschließt.

- Für weitere Informationen zum Inhalt der Menüs sich auf die Abschnitte "Verwendung der REC-Menüs" auf Seite G-79 und "Verwendung der PLAY-Menüs" auf Seite G-90 beziehen.

Anzeige im REC-Modus

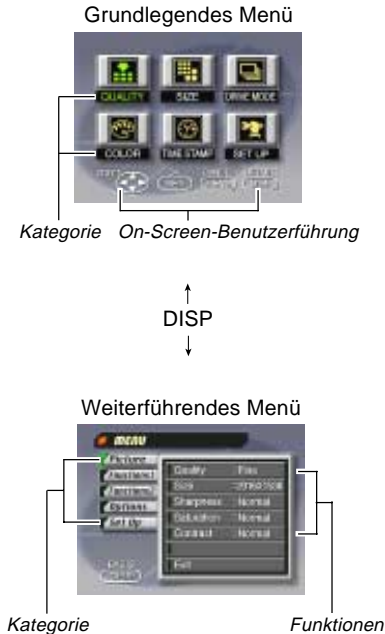

Ausführung von Menüeinstellungen

1. Die MENU-Taste drücken.
2. Falls Sie sich in dem REC-Modus befinden, drücken Sie die DISP-Taste, um zwischen dem grundlegenden Menü und dem weiterführenden Menü umzuschalten.
3. Die [▶]-, [◀]-, [▼]- und [▲]-Tasten verwenden, um die gewünschte Kategorie bzw. Funktion zu wählen, dann die SET/Q-Taste drücken.

[▶] [◀] [▼] [▲]: Wahl eines Postens

SET/Q : Führt eine Wahl aus.

MENU : Kehrt an die vorhergehende Bildschirmanzeige zurück oder bricht die Einstellungen ab.

- Nehmen Sie die Einstellungen in Übereinstimmung mit den Anweisungen vor, die am Monitorbildschirm angezeigt werden.

4. Nachdem die gewünschten Einstellungen eingegeben wurden, wählen Sie "Exit"; drücken Sie dann die SET/Q-Taste.

MEMORY CARDS

This camera uses a memory card (CompactFlash card or microdrive) for image storage.

▶▶ IMPORTANT! ◀◀

- Make sure that the power of the camera is turned off before you insert or remove a memory card.
- When inserting a memory card into the camera, make sure that the card is oriented correctly. Make sure that the correct side of the card is facing up, and that you insert the correct end of the card into the camera.

Inserting a Memory Card into the Camera

1. Open the memory card slot cover.

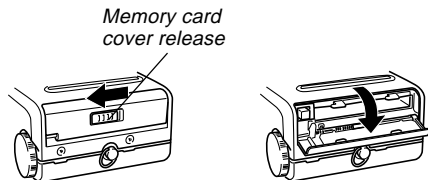

2. As shown in the illustration, slide the memory card into the slot and push it in as far as it will go.

- If the Eject button is extended, press it in before sliding the memory card into the slot.

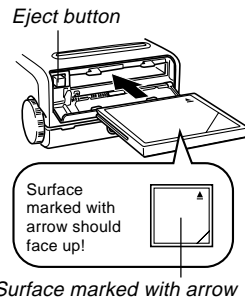

3. Close the memory card slot cover.

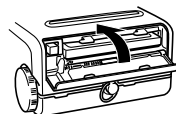

Removing a Memory Card from the Camera

1. Open the memory card slot cover.

*Memory card
cover release*

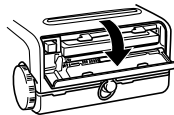
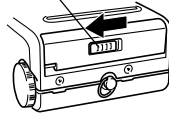

2. Press the eject button so it extends from the camera.

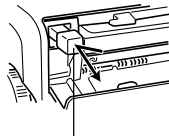

Eject button

3. Press the eject button once again to eject the card.

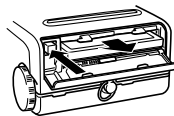

4. Remove the memory card.

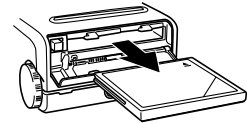

5. Close the memory card slot cover.

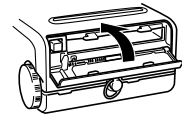

▶▶ IMPORTANT! ◀◀

- Insert only memory cards into the memory card slot. Inserting any other type of card can cause malfunction.
- Should water or any other foreign matter get into the memory card slot, immediately turn off power, unplug the AC adapter, and contact your original retailer or nearest CASIO Service Provider.
- Never eject the CompactFlash card while the card slot is facing downwards. Doing so creates the danger of the CompactFlash card falling, which can corrupt image data on the card.
- Never remove the memory card from the camera while Power/Function lamp or Operation lamp is flashing. Doing so can cause loss of recorded images or corruption of memory card data.

Formatting a Memory Card

You can format a memory card to delete all of the data stored on it.

▶▶ IMPORTANT! ◀◀

- Formatting a memory card deletes all images on the card, even if some or all of the images are protected (page E-94).
- Data deleted by a memory card format operation cannot be recovered! Be sure to carefully check and confirm that you no longer need the data stored in a memory card before formatting it.

1. Press **MENU**.
2. Select **“SET UP”** → **“Format”**.
3. In response to the confirmation message that appears, select **“Yes”** to start formatting the card.

Memory Card Precautions

- Images cannot be recorded with this camera unless a memory card is installed in it.
- Be sure to use only CASIO brand CompactFlash cards. Proper operation with other memory cards is not guaranteed.
- Static electricity, electrical noise, and other electrical phenomena can cause corruption or even total loss of the data stored on a memory card. Because of this, you should always make backup copies of important images on other media (magnetic optical disk, floppy diskette, computer hard disk, etc.).
- Memory card problems can be corrected by reformatting the memory card (page E-119). Reformatting a memory card deletes all images stored on the card, but you can use a computer to copy the images you want to keep to the computer's hard disk before reformatting your card. If you plan to be recording images where you do not have access to a computer, it is a good idea to take along an extra memory card or two just in case you experience an unexpected memory card problem.

- Formatting is recommended for any memory card that you suspect contains corrupted image data (due to a DE-CODE ERROR, strange image colors, malformed images) or newly purchased memory cards.
- Before starting a format operation, connect the AC adapter to power the camera. Interruption of camera power during the format operation results in improper formatting, making it impossible to use the memory card.

IBM Microdrive Precautions

Compatibility of the camera with the IBM microdrive has been confirmed by CASIO. However, you should note the following important points whenever using the IBM microdrive.

- Be sure to carefully read all of the documentation that comes with the microdrive before using it.
- Note that the microdrive becomes hot during normal use. Take care when removing it from the camera.
- Take care to avoid strong pressure on the label side of the microdrive when it is removed from the camera. Strong pressure can damage internal components and cause malfunction.
- Never remove the battery, unplug the AC adapter, or subject the camera to impact while the Power/Function lamp or Operation lamp is flashing. Doing so can cause malfunction of the microdrive.

- The microdrive is a very high precision device. Dropping the camera can result in malfunction of the microdrive, even though the camera is undamaged. Take extra care when handling the camera while the microdrive is installed.
- The microdrive has very large storage capacity. Because of this, certain operations can take a relatively long time to perform.
- The microdrive may not operate properly in areas where barometric pressure is low. Because of this, you should avoid using it at high altitudes.
- When battery power is low, the amount of time required between shots may become longer. This longer interval is designed to protect the microdrive.

In case of microdrive malfunction....

- Contact your original microdrive retailer or the contact point noted in the microdrive documentation.
- CASIO does not provide any servicing or maintenance support for the microdrive.
- Note that CASIO assume no responsibility for any data loss you may suffer while using the microdrive.

Memory Card Folder Precautions

- The camera automatically creates folders (directories) on the memory card and assigns them names based on dates (month and day). Any image you record is automatically stored into the folder that corresponds to the date it is recorded.
- Up to 900 folders can be created on a single card. The following shows a typical folder name.

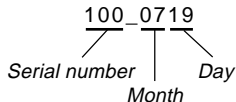

- Up to 250 image files can be stored in each folder. The following shows a typical file name.

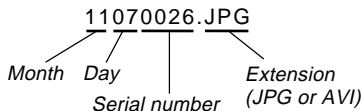

- When you try to save the 251st image to a folder, the camera automatically creates a new folder and store the image there.
- The above maximum numbers of files and folders are absolute maximums. The actual numbers of folders and files may be less due to memory card capacity and the size of each image.
- Panorama images are divided into multiple images and stored on the memory card.
- See “USING CompactFlash CARDS WITH YOUR COMPUTER” on page E-108 for information about how files and folders are organized.

POWER SUPPLY

This camera can be powered by a special lithium ion battery (NP-L7) or by household AC power.

- Do not use other types of AA-size batteries.

Loading the Battery

Make sure that camera power is turned off whenever loading or replacing the battery.

- 1. On the bottom of the camera, slide the battery compartment cover lock in the direction indicated by arrow (1) in the illustration. Next, slide the cover in the direction indicated by arrows (2) and open the cover.**
- 2. Orient the battery as shown in the illustration and load it into the camera.**

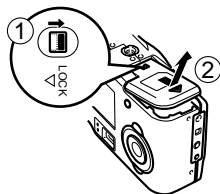

- 3. While pushing the battery compartment cover in the direction indicated by arrow (1), slide it shut and then slide the lock in the direction indicated by arrow (2).**

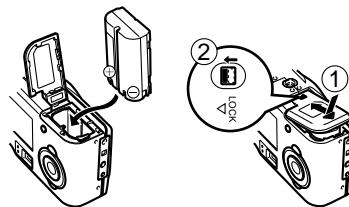

- The camera is designed so the battery can be loaded only when it is oriented as described above. If the battery does not enter the compartment smoothly, never try to force it. Doing so can damage the camera.

Battery Operation Time Guidelines

The table below shows the approximate amount of continuous operation you can expect under normal temperature (25°C) when the special lithium ion battery is fully charged. Note that these values are approximations only, and do not guarantee that you will be able to obtain such performance from your battery.

▶▶ IMPORTANT! ◀◀

- Use only the BC-7LA AC Adapter/Charger to charge the battery.
- Be sure to charge the lithium ion Rechargeable battery (NP-L7) before using it for the first time.
- The battery cannot be charged while it is installed in the camera.
- The battery discharges naturally even when it is not loaded in the camera. Be sure to charge a battery before using it to power the camera.

Battery Type	Approximate Continuous Play Time	Approximate Continuous Record Time
NP-L7 Lithium Ion Rechargeable Battery	100 minutes	65 minutes (390 shots) with the monitor screen turned on
		270 minutes (1,620 shots) with the monitor screen turned off

● Continuous Play/Record Times

- The times noted are for reference purposes only, and do not guarantee operation for the times noted.
- The times noted indicate the time it takes until loss of power from a new fully-charged lithium ion rechargeable battery being used for continuous operation under standard temperature (25°C). Times are made shorter by cold temperatures and the number of times batteries have been charged.

● Continuous Record Time

- The time indicated is for continuous recording without flash. Recording one image per minute under the above conditions reduces battery life to about one sixth of that noted above. The number of shots that can be recorded is greatly affected by use of the flash and by how often power is turned on and off.

● Tips for Prolonging Battery Life

- When using the viewfinder to compose images, press the DISP button a number of times until the monitor screen turns off. Turning off the monitor screen uses less battery power.
- Use the  INFO button to turn off the flash when you are not using it.
- You can also use the power save settings (E-46) to protect against wasting battery power when you forget to turn off the camera.



● Low Temperature Precautions









- Your digital camera requires large amounts of current for proper operation. The amount of operation provided by its lithium ion rechargeable batteries is greatly reduced by use at temperatures that are colder than 25°C. The following steps are recommended when using the camera under low temperatures (below 10°C).
 - Keep the battery, with its cap in place, inside your pocket and load it in the camera until just before you plan to use it. Keep the battery away from direct contact with pocket heaters or other sources of heat.
 - Turn off the monitor screen and use the optical viewfinder to compose images.
 - Prepare extra sets of charged lithium batteries for replacement.
 - Use the AC adapter to power the camera.
 - Use a CompactFlash card to store images instead of a microdrive.

Intermittent Operation

- Intermittent operation dramatically reduces battery capacity. You can expect about one hour of operation (about 55 images) under room temperature (25°C) when repeating a cycle during which you spend 10 minutes recording one image per minute (with flash), followed by one minute of playback, and then nine minutes of power off.
- The same sequence as described above results in about 12 minutes of operation (about 11 images) when performed at 0°C.

Low Battery Indicator

The following shows how the battery capacity indicator on the monitor screen and the indicator display changes as battery power is used. Replace all four batteries as soon as possible after they go dead. If you continue to use the camera while the battery level is  or , camera power will automatically turn off.

Battery Capacity	High ←————→ Low
Monitor Screen	 →  →  → 
Indicator Display	 →  →  → 

- The low battery indicator is intended as a general reference only. Battery characteristics, operating conditions, temperature, and other factors can also affect battery capacity.

AC Adapter/Charger

The AC Adapter/Charger is used for recharging the lithium ion battery and for directly powering the camera using AC power.

- It takes approximately 150 minutes to bring a battery to a full charge.
- Actual charging time depends on the battery capacity, the battery's current charge level, the temperature of the location where you are charging, etc.

▶▶ IMPORTANT! ◀◀

- Make sure you carefully read the documentation that comes with the lithium-ion battery and the AC adapter/charger before using them.

Auto Power Off (Battery Powered Operation Only)

Power automatically turns off whenever you do not perform any camera operation for a specific period. See page E-46 for details about how you can specify the Auto Power Off time.

- To restore power, hold down the Power/Function switch and slide it to OFF and then back to REC or PLAY.

▶▶ IMPORTANT! ◀◀

- The Auto Power Off function does not operate under the following conditions.
 - During Slide Show (page E-89)
 - While the camera is being operated from a computer (pages E-105 to 107).
 - Whenever the AC adapter is connected to the camera.

Using AC Power

Use the optional AC adapter (AD-C620) or the special AC adapter/charger (BC-7LA) to power the camera on standard AC power.

- Note that the BC-7LA AC adapter/charger comes with power cords that are compatible with local wall outlet configurations. Be sure to use the power cord that is compatible with the wall outlets in the area where you are using the adapter/charger.

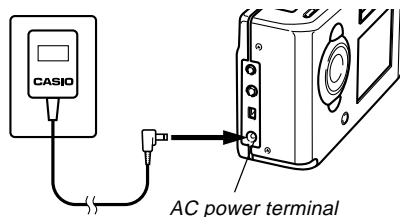

AC Adapter precautions

- Never use an electrical outlet whose voltage is outside the rating marked on the AC adapter. Doing so can create the danger of fire or electrical shock. Use only the optional AC adapter specified for this camera.
- Should the cord of the AC adapter become damaged (exposed internal wiring), request a replacement from an authorized CASIO service provider. A damaged AC adapter cord creates the danger of fire or electrical shock.
- Use only the BC-7LA AC adapter/charger or the AD-C620 AC adapter only to power the camera. Using any other type of AC adapter can cause damage to the camera not covered by the warranty.
- When unplugging the AD-C620 AC adapter from the wall outlet, be sure to grasp the adapter, not the cord.
- Avoid any undue bending, pulling, and twisting of the AC adapter's cord, and never try to lengthen the cord by splicing it with other wire.

- Be sure to turn off power before connecting or disconnecting the adapter.
- Always turn camera power off before disconnecting the AC adapter, even if the camera has batteries installed. If you don't, the camera will turn off automatically when you disconnect the AC adapter. You also run the risk of damaging the camera whenever you disconnect the AC adapter without first turning power off.
- The AC adapter may become warm to the touch after extended periods of use. This is normal and is not cause for alarm.
- After using the camera, turn it off and unplug the adapter from the AC outlet.
- The camera automatically switches over to AC adapter powered operation whenever the AC adapter is plugged into the camera.
- Always use the AC adapter to power the camera whenever it is connected to a computer.

Power Save Settings

The settings described below let you specify sleep and auto power off trigger times that help to conserve valuable battery power.

SLEEP The monitor screen enters a sleep state if no operation is performed for a specified amount of time in the Record Mode. Pressing any button restores full power. You can specify 30 seconds, one minute, or two minutes before the sleep state is triggered, or you can turn off this setting entirely.

AUTO

POWER OFF Auto Power Off turns off camera power if no operation is performed for five minutes in the PLAY mode, or for two or five minutes in the REC mode.

- AUTO POWER OFF takes priority when both SLEEP and AUTO POWER OFF are set for a 2-minute trigger time. This means camera power turns off if no operation is performed after two minutes.

Setting SLEEP and AUTO POWER OFF Trigger Times

1. Pressing down the Power/Function switch, slide it to REC.
2. Press MENU.
3. Select “Options” → “Power Save” → “Power Save”.
 - “Options” appears on the advanced menu only.



4. Use [▼] and [▲] to select “Sleep” or “Auto Power Off”.
5. Select the trigger time you want to set.
6. When the settings are the way you want them, press SET/Q .
7. Select “Exit”.

Initializing Power Save Trigger Times

Use the following procedure to return SLEEP and AUTO POWER OFF trigger time settings to their initial factory defaults (SLEEP: 1 minute, AUTO POWER OFF: 2 minutes).

▶▶ IMPORTANT! ◀◀

- Note that performing the following procedure to initialize the power save trigger time settings also initializes mode memory (page E-78).

1. Pressing down the Power/Function switch, slide it to REC.
2. Press MENU.
3. Select “Options” → “Power Save” → “Power Save”.
 - “Options” appears on the advanced menu only.
4. Use [▼] or [▲] to select “Sleep” or “Auto Power Off”.
5. Select “Restore”.
6. Select “Exit”.

SETTING THE CURRENT DATE AND TIME

Use the following procedures to set the current date and time, and to select the date format. When you record an image, the time and date the image was shot is registered in accordance with data from the camera's built-in clock. You can even use the TIME STAMP function to "stamp" the date and time inside the image.

))) IMPORTANT! (((

- The time and date settings are cleared if the camera is left for about 48 hours without battery and AC power being supplied. If this happens, restore power and make new time and date settings before using the camera again.
- Even when charging the battery, the AC Adapter/Charger still will provide memory backup power to the camera. We recommend that you leave the camera connected to the AC Adapter/Charger with the DC cord while charging the battery.
- A flashing time display indicates that the time and date (clock) settings have been cleared. Use the procedure on this page to make the correct time and date settings.
- If you do not set the camera's built-in clock to the current date and time, all images are recorded with the default date and time, which probably is not your correct current date and time. Be sure to correctly set the clock before you use the camera.

Setting the Date and Time

1. Press **MENU**.
2. Select **"SET UP"** → **"Date"** → **"Adjust"**.



3. Set the current date and time.

- Press [▼] and [▲] to change the value or setting at the location of the green marker.
- On the menus, the currently selected item is indicated by the color green. Either the menu item is highlighted in green, or a green marker appears to the left of the menu item to indicate that it is selected.
- Use [▶] and [◀] to move the green marker to the setting you want to change.

4. After making all the settings on the monitor screen, press SET/Q to register them.

Selecting the Date Format

Example: May 1, 2000

You can select any one of the following formats for the above date: 00/5/1, 1/5/00, 5/1/00.

1. Press MENU.
2. Select "SET UP" → "Date" → "Style".



3. Use [▼] and [▲] to select the date format you want, and then press SET/Q .

RECORDING

Turning Camera Power On and Off

Use the Power/Function switch to turn camera power on and off.

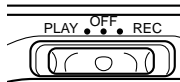

REC : Turns on power and enters the REC mode.

PLAY : Turns on power and enters the PLAY mode.

OFF : Turns off power.

▶▶ IMPORTANT! ◀◀

- Slide the Power/Function switch while pressing down on it.
- Never turn on power while the lens is facing downwards.
- To restore camera power after it has been turned off by auto power off, hold down the Power/Function switch and slide it to OFF and then back to REC or PLAY.

Using the Shutter Button

The following steps describe how to operate the shutter button so that Auto Focus has a chance to focus the image.

1. Press the shutter button about half way.

- The Auto Focus feature automatically focuses the image.
- The Operation lamp lights green and the Auto Focus Frame in the monitor screen turns green when the Auto Focus operation is complete.

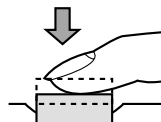

2. Press the shutter button as far as it will go to record the image.

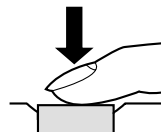

Recording a Single Snapshot Image

The following is the basic procedure for recording a single snapshot image. It uses the Program AE Mode (P Mode), which makes automatic aperture and shutter settings when you press the shutter button.

- If you keep the shutter button depressed, the camera continually records up to five images at an interval of about 2.5 seconds. The interval required to record images becomes longer after the first five images.

1. Set the Record Mode Dial to P (Program AE Mode).



2. Pressing down the Power/Function switch, slide it to REC.

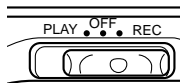

3. After composing the image on the monitor screen, press the shutter button about half way and hold it there.



- The monitor screen image may become dim when you press the shutter button half way.
- The camera's Auto Focus feature automatically focuses the image.
- The Operation lamp lights green and the Auto Focus Frame in the monitor screen turns green when the Auto Focus operation is complete.
- If you plan to use the viewfinder to compose the image, press DISP several times until the monitor screen turns off.
- Take care to avoid blocking the lens, distance sensor or light sensor with your fingers.
- Press the shutter button carefully, taking care not to move the camera as you do.

4. After confirming that the Auto Focus operation is complete (the operation lamp lights green), press the shutter button all the way down to record the image.

- Images you record are temporarily stored in the camera's buffer memory, from which they are subsequently transferred to the memory card installed in the camera. You can continue to shoot consecutive images until buffer memory becomes full.
- Pressing the shutter button releases the shutter, even if Auto Focus was unsuccessful and the image is out of focus.
- Use of a tripod is recommended for slow shutter speeds and digital zoom recording in order to avoid blurring of the image due to camera movement.

▶▶ IMPORTANT! ◀◀

- Never remove the memory card from the camera while images are being saved to the memory card, which is indicated when the Power/Function lamp is flashing. Doing so will cause the images you just recorded to be lost.
- The record mode does not change immediately if you change the Record Mode Dial setting while images are being saved to the memory card.
- Turning off power before images are saved to the memory card causes the images to be lost.
- The message "Insert memory card!" appears on the monitor screen if you press the shutter button while there is no memory card loaded in the camera.
- Continuous recording at an interval of 2.5 seconds is not possible in the following cases: while the flash is charging, at slow shutter speeds in the Night Scene Mode, or when Auto Focus requires more time to focus.

▶▶ IMPORTANT! ◀◀

Auto Focus tends not to work well with the following types of subjects.

- Solid color walls or objects with little contrast
- Strongly backlit objects
- Polished metal or other brightly reflective objects
- Venetian blinds or other horizontally repeating patterns
- Multiple images that are varying distances from the camera
- Subjects in poorly lit areas
- Auto Focus also may not work properly when the camera is unsteady or shaking.

These cases may make it impossible for Auto Focus to focus properly, which is indicated by the Operation lamp and the Auto Focus Frame inside the monitor screen remaining red. When this happens switch to the Manual Mode for focusing (page E-64). The following are the fixed focusing distances when Auto Focus is unable to focus.

Well-lit Location: 1.5 meters (4.9') minimum
With Flash: Approximately 2 meters (6.6')

Depending on actual conditions, a green Operation lamp and Auto Focus Frame do not necessarily guarantee that the image is in focus. Also, dim lighting can cause Auto Focus to take a long time.

▶▶ CAUTION ◀◀

- Never open the battery compartment cover, disconnect the AC adapter from the camera, or unplug the adapter from the wall socket while the Power/Function lamp or Operation lamp is flashing. Doing so will not only make storage of the current image impossible, it can also corrupt other image data already stored in camera memory.
- Fluorescent lighting actually flickers at a frequency that cannot be detected by the human eye. When using the camera indoors under such lighting, you may experience some brightness or color problems with recorded images, or with auto focus distance measurements.

Recording Images under Low Battery Power

To protect against unexpected loss of image data, images are recorded one-by-one whenever the battery level is indicated as  or lower. During the save operation, the message “Press (DISP) to cancel save.” is on the monitor screen. As long as you do not press DISP, the save operation continues for a few seconds. Be sure to replace the battery as soon as possible after this message starts to appear. Pressing DISP while the “Press (DISP) to cancel save.” is on the monitor screen causes the image save operation to be cancelled.

▶▶ IMPORTANT! ◀◀

- The message described above does not appear while the monitor screen is turned off.
- The message appears for each image recorded when the battery level is  while using a microdrive.

Using the Viewfinder for Recording

The illustrations below show what you see when you look through the viewfinder to compose an image for recording.

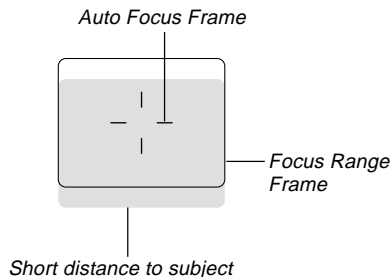

Note that the focus range frame is valid for subjects that are about three meters (9.8') away. A different focus range is used for subjects that are closer or farther away. Because of this, you should use MF/∞/👤  to change to the Manual Focus Mode (MF) or Macro Mode (👤) whenever the distance between the camera and the subject is 50cm or less.

- The monitor screen turns on automatically whenever the camera is in the Macro Mode. Use the monitor screen to compose images in the Macro Mode.

Using Focus Lock

Normally, Auto Focus automatically focuses on the object that is inside the Auto Focus Frame. Focus lock is a technique that lets you lock the focus on a subject and then move the camera so the Auto Focus Frame is pointed at another subject when you record. This keeps the original subject in focus, even though a different object is within the Auto Focus Frame.

- Locking the focus also locks the exposure setting.

1. Align the Auto Focus Frame with the subject you want to lock on and press the shutter button half way down.

- The monitor screen image may become dim when you press the shutter button half way.
- The Auto Focus frame turns green when the image is in focus.



2. While keeping the shutter button depressed half way, move the camera and compose the image as you want.



3. Press the shutter button all the way down to record the image.

Using the Flash

You can use the built-in flash unit to provide illumination during recording.

1. Press **⚡** INFO.

- Each press of **⚡** INFO cycles through the flash mode in the following sequence: Auto (None) → Off (🚫) → On (⚡) → Red-eye Reduction (👁).

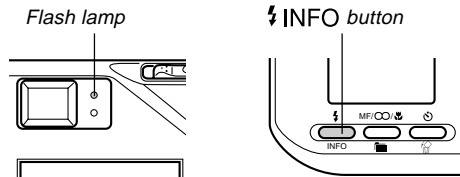

Indicator	Flash Mode	Description
None	Auto Flash	Flash is automatically enabled and disabled in accordance with exposure conditions.
🚫	Flash Off	Flash is never fired, regardless of exposure conditions.
⚡	Flash On	Flash is always fired, regardless of exposure conditions.
👁	Red-eye Reduction	Fires a pre-flash followed by recording with flash, which reduces the chance of red-eye.

- The monitor screen goes blank and the Flash lamp flashes amber while the flash unit is charging.

Camera Shake Indicator

The **⚡** (camera shake) indicator appears on the monitor screen when a slow shutter speed is being used.

Flash Indicator

When you press the shutter button half way, the flash icon appears on the monitor screen and the Flash lamp light (amber) to indicate that the flash will fire when the shutter button is pressed the rest of the way down.

▶▶ IMPORTANT! ◀◀

- Never use the flash in areas where combustible or explosive gas is present. Doing so creates the danger of fire and explosion.
- Never fire the flash in the direction of a person operating a motor vehicle. Doing so can interfere with the driver's vision and create the danger of accident.
- Never fire the flash while it is too close to the subject's eyes. Intense light from the flash can cause eye damage if it is fired too close to the eyes, especially with young children. When using the flash, the camera should be at least one meter from the eyes of the subject.
- Make sure that you do not touch or block the flash or exposure sensor with your fingers. Doing so can soil these components and interfere with correct flash operation.

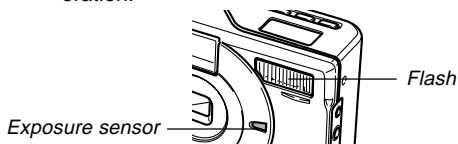

- Flash should be used for distances within the range of about 0.7 meters (2.3') to 3 meters (9.8') (values with fully open aperture). Flash does not work well outside these ranges.
- Depending on operating conditions (type of batteries being used, temperature, etc.), it may take up to 40 seconds for the flash unit to charge.
- The flash is disabled during movie and continuous recording, which is indicated by the flash icon appearing on the monitor screen.
- The flash unit does not charge when battery power is low. The  indicator appears to warn you that the flash will not fire correctly, which may affect exposure of the image. Replace batteries as soon as possible when this happens.
- Red-eye reduction may not work well when the camera is not pointed directly at the subject or when the subject is far from the camera.
- In the Red-eye Reduction Mode, the flash is fired automatically in accordance with exposure. Because of this, the flash does not fire in a well-lit area.
- In the Manual Mode (M Mode), the flash does not fire if Auto Mode or Red-eye Reduction Mode is currently selected as the flash mode.
- White balance is fixed while the flash is being used, so the coloring of the recorded image may be affected by sunlight, fluorescent lighting, or other sources of illumination in the immediate area.

About Sync Speeds

You can use the procedure under “Using the REC Menus” on page E-79 to specify the shutter speed you want when using the flash. You can select one of the following three sync speed settings.

When you want to do this: **Select this setting:**

Shoot at a shutter speed of 1/125 Fast second, which reduces blurring due to subject or hand movement. Use this setting when you want to record indoor images of children playing indoors, etc.

Shoot at a shutter speed of 1/60 sec- Normal ond.

Shoot at a shutter speed of 1/30 sec- Slow ond, which makes the background lighter (but increases the chance of blurring due to hand movement).

▶▶ IMPORTANT! ◀◀

- In the Manual Mode (M Mode), the manually set shutter speed takes priority over the above setting.

Quality Settings

The camera has three quality modes: FINE, NORMAL, ECONOMY.

- To determine the number of images that can be stored on a memory card (CompactFlash card or microdrive) of a different capacity, multiply the capacities in the table below, by the appropriate value.
- The actual number of images that can be stored in memory cannot be specified precisely because the amount of memory required for storage of each image differs according to image contents.

Image size (pixels)	Quality	File size (per image)	Number of images		
			8MB CompactFlash card	64MB CompactFlash card	340MB Microdrive
2016 x 1536	FINE	1.4 MB/image	5 images	43 images	245 images
	NORMAL	1 MB/image	6 images	60 images	342 images
	ECONOMY	600 KB/image	11 images	99 images	562 images
1008 x 768	FINE	350 KB/image	19 images	167 images	943 images
	NORMAL	250 KB/image	27 images	229 images	1292 images
	ECONOMY	150 KB/image	43 images	365 images	2054 images

- Numbers in parentheses are compressed image file sizes.
- Use the REC menus (page E-79) to select the quality setting you want.
- Note that the maximum number of images that can be stored in a single folder is 250. Because of this, even if you are using a card that allows storage of more than 250 images, the camera's monitor screen will show capacity for up to 250 images only. You can store additional images by changing to another folder.
- The number of images that can be recorded may differ when you use Card Browser (page E-111).

Exposure Compensation

This camera features an program AE function that automatically changes shutter speed and aperture in accordance with available light. In addition, you can also manually adjust the exposure to compensate for backlighting, indirect indoor lighting, dark backgrounds, and other special conditions.

- Press DISP to turn on the monitor screen (page E-31).
- Exposure compensation is disabled in the Manual Mode (M Mode).

1. Use [▶] and [◀] to perform exposure compensation.

- Pressing [▶] or [◀] displays an EV indicator that shows the current exposure compensation setting.
- Pressing [▶] makes the image on the monitor screen brighter. Use it to adjust for dim indoor lighting and backlighting.
- Pressing [◀] makes the image on the monitor screen darker. Use it to adjust for bright sunlight.
- The EV indicator turns red whenever the compensation value is at its limit.

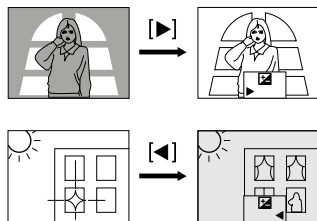

2. After adjusting the exposure, press the shutter button to record the image.

»» NOTES ««

- Exposure compensation is generally expressed in terms of an exposure compensation (EV) value. The exposure compensation value is always set to zero whenever you turn on the camera.
- Each press of [▶] or [◀] changes the exposure compensation value by 1/3EV. A change in either direction is indicated on the monitor screen by arrows pointing left (negative correction) or right (positive correction).
- The normal maximum range for exposure compensation is -2EV to +2EV. Under certain conditions, however, the camera may impose lower maximum values when exposure compensation would result in an image that is too dark or too light.

- The exposure compensation value automatically reverts to zero whenever the shutter button is pressed. You can manually reset the exposure compensation value by using [▶] and [◀] to change the value back to zero, which is indicated when the EV indicator disappears from the monitor. EV value is fixed during panorama recording.

OTHER RECORDING FUNCTIONS

This section describes more advanced recording operations that are also provided by this camera.

- Use the monitor screen for digital zoom, manual focus, macro, movie, panorama, and multiple exposure.

Using the Continuous Shutter Mode

The Continuous Shutter Mode lets you record five*¹ images at 1-second intervals. It can be used for normal recording, as well as in the Program AE (P Mode), Aperture Priority Auto (A Mode), Manual (M Mode), Night Scene and Landscape modes.

*¹ When recording is performed with the monitor screen turned off. More than five images may be possible under certain conditions.

- 1. Pressing down the Power/Function switch, slide it to REC.**
- 2. Press MENU.**
- 3. Select “Functions 1” → “Drive Mode” → “Continuous”.**
 - “Functions 1” appears on the advanced menu only.
 - The “” indicator is on the monitor screen while the Continuous Shutter Mode is selected.

4. Compose the image and then record it.

- Focus is locked when you record the first image, and this setting is applied to all subsequent images.
- The flash does not fire in the Continuous Shutter Mode.
- You may be able to record four*² images in the Continuous Shutter Mode when using the Night Scene Mode, a fixed shutter speed, or a slow shutter speed.
*² More than four images may be possible under certain conditions.
- Do not start a Continuous Shutter Mode operation when the low battery indicator is on the monitor screen.
- Never remove camera batteries, unplug the AC adapter from the camera, or remove the memory card while images are being saved.

Using the AEB (Automatic Exposure Bracketing) Mode

The AEB Mode automatically records three images when you press the shutter button: one at $\pm 0\text{EV}$, one at -0.5EV , and one at $+0.5\text{EV}$.

- 1. Pressing down the Power/Function switch, slide it to REC.**
- 2. Press MENU.**
- 3. Use [▶], [◀], [▼] and [▲] to select “DRIVE MODE” and then press SET/Q .**
 - On the advanced menu, select “Functions 1” → “Drive Mode.”
- 4. Use [▼] and [▲] to select “AEB”, and then press SET/Q .**
 - This causes the recording mode indicator on the monitor screen to change to “AEB”, indicating you are in the AEB Mode.

5. Compose the image and then record it.

- Since three images are recorded, it may take some time for them all to be saved to the memory card.

▶▶ IMPORTANT! ◀◀

- Note that the flash does not fire in the AEB Mode.

Using Digital Zoom

The center of the display screen can be enlarged to one of 12 steps to record a 1008 x 768-pixel image.

Zoom Factors (Steps): 1, 1.2, 1.4, 1.6, 1.8, 2, 2.2, 2.4, 2.6, 2.8, 3, 3.2

- Images recorded using digital zoom may be somewhat grainy.
- The image in the optical viewfinder does not reflect the results of zoom operations. Use the monitor screen to compose your image when using digital zoom.

1. Pressing down the Power/Function switch, slide it to REC.

2. Press SET/Q or [▲] to display the current digital zoom factor on the right side of the monitor screen.

- If you are in the Aperture Priority Auto Mode (A Mode), Manual Mode (M Mode) or Landscape Mode, press SET/Q to display the digital zoom factor. Be sure you make aperture and color filter settings before pressing SET/Q to make digital zoom settings (page E-70 to 72).

3. While the digital zoom factor is on the monitor screen, press [▼] to decrease it or [▲] to increase it.

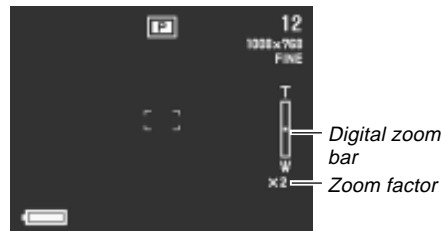

4. Compose the image and then record it.

- After you are finished recording the image, press SET/Q to clear the digital zoom factor from the monitor screen.

Manual Focus

Manual Focus lets you manually adjust the focus of an image.

1. Pressing down the Power/Function switch, slide it to REC.



2. Press MF/∞/🌻  a number of times until the MF indicator appears on the monitor screen.

- Each press of MF/∞/🌻  cycles the focus mode in the following sequence: Auto Focus → Manual Focus (MF) → Infinity (∞) → Macro (🌻).

3. While “MF” is flashing on the monitor screen, use [◀], [▼] or [▶], [▲] to focus the image.

[◀], [▼] Narrows the focus range.

[▶], [▲] Widens the focus range.





- If you do not perform any focus operation for about two seconds, the “MF” indicator stops flashing.
- After “MF” stops flashing, you can use [▶] and [◀] to adjust exposure compensation (EV).
- If “MF” stops flashing before you have a chance to focus, press MF/∞/🌻  to make “MF” flash again.
- Pressing MF/∞/🌻  while “MF” is flashing changes the focus mode to Infinity.

4. Compose the image and then record it.

- The Operation lamp and the Auto Focus frame do not appear while manual focus is in use.

Infinity Mode Recording







Use the Infinity Mode when recording images of scenery or objects that are far away. This mode performs Auto Focus in the vicinity of infinity (∞).

- Pressing down the Power/Function switch, slide it to REC.**
- Press MF/ ∞ /  a number of times until the ∞ indicator appears on the monitor screen.**
 - Each press of MF/ ∞ /  cycles the focus mode in the following sequence: Auto Focus \rightarrow Manual Focus (MF) \rightarrow Infinity (∞) \rightarrow Macro ().
- Compose the image and then record it.**

Using the Macro Mode

Use the Macro Mode for close up shots in the focusing ranges shown below.

Approximate Focusing Range : 10cm to 50cm (3.9" to 19.7")

- The focusing range is the distance from the lens surface to the subject.
 - With the macro mode, use the monitor screen to compose the image. Do not use the viewfinder.
- Pressing down the Power/Function switch, slide it to REC.**
 - Press MF/ ∞ /  a number of times until the  indicator appears on the monitor screen.**
 - Each press of MF/ ∞ /  cycles the focus mode in the following sequence: Auto Focus \rightarrow Manual Focus (MF) \rightarrow Infinity (∞) \rightarrow Macro (.
 - Compose the image and then record it.**

Movie Recording

You can record movies that are approximately 30 seconds long. Movies are recorded in 320 x 240-pixel AVI format. For details, see “Using the REC Menus” on page E-79.

There are two types of movie recording: PAST and NORMAL. PAST lets you capture images of events that occurred before you pressed the shutter button while NORMAL records what happens after you press the shutter button.

See “Using the REC Menus” on page E-79 for details on how to select the movie length.

- AVI files can be displayed and saved on a computer that is set up to support use of CompactFlash cards. For such a computer, install QuickTime, which comes bundled with the camera.

NORMAL

1. Pressing down the Power/Function switch, slide it to REC.
2. Align the dial with .

3. Compose the image and then press the shutter button to start recording.

- See “Playing Back a Movie” on page E-84 for details on playing back a movie.
- Movie recording stops automatically 30 seconds after you start the record operation.
- To stop recording before the 30-second period is up, press the shutter button again.

PAST

1. Pressing down the Power/Function switch, slide it to REC.
2. Press MENU.
3. Select “Functions 2” → “Movie Mode” → “Past”.
 - “Functions 2” appears on the advanced menu only.
4. Align the dial with .

5. Compose the image on the monitor screen and then press the shutter button about half way.

- The message “STAND BY” appears on the monitor screen to indicate that the camera’s buffer memory is accumulating image data. This message remains displayed for about 10 seconds.
- After “STAND BY” disappears from the monitor screen, the contents of the buffer memory continues to be updated as long as you keep the shutter button depressed about half way.

6. Keep the camera pointed at the action you want to record, and press the shutter button all the way down when you want to end recording.

- Pressing the shutter button after “STAND BY” disappears from the monitor screen records everything that went on in front of the lens during the 10-second period before you pressed the shutter button.
- Pressing the shutter button while “STAND BY” is still on the monitor screen records everything that went on in front of the lens during the period from when you pressed the shutter button half way down and when you pressed it all the way down. In this case, the recording will be less than 10 seconds long.

NOTE

- Movie Storage Capacity

Storage Capacity	Approximately 220 KB/second
Recording Time	30 seconds per movie (NORMAL) 10 seconds per movie (PAST)

IMPORTANT!

- Flash is disabled during movie recording.
- In the Movie Mode, the auto focus and white balance settings at the start of the recording operation are used throughout.
- If the distance between the camera and the subject changing while recording is in progress, you should use focus lock (page E-55) to lock focus at the distance you want, or manually adjust the focus (page E-64) as required.

Panorama Recording

With panorama recording you record a series of images and then link them to create a single panoramic effect.

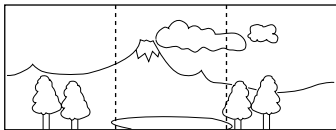

1. Pressing down the Power/Function switch, slide it to REC.

2. Align the dial with .

3. Compose the image and then record it.

- The left edge of the previous image you recorded remains on the monitor screen, so you can align it correctly with the next image.
- From the second image onwards, aim the camera further to the left and overlap the next image with the previous one on the monitor screen.
- Up to nine images can be grouped into a panorama. Press MENU when you want to stop a panorama recording operation.

- Aperture setting and white balance settings are locked when you record the first image of a panorama, and these settings are applied to all subsequent images in that panorama.
- If you want to link more than 9 images into a panorama, upload the images to a computer and use a commercially available computer application to link them.
- See “Panorama Playback” on page E-85 for details on playing back panoramas.

Night Scene Mode

The Night Scene Mode is for recording images in dark areas. When recording images of people on a twilight or night time background, you can use the flash in combination with the Night Scene Mode for slow synchro recording.



1. Pressing down the Power/Function switch, slide it to REC.
2. Align the dial with .
3. Compose the image and then record it.

▶▶ IMPORTANT! ◀◀

- The shutter speed is quite slow in the Night Scene Mode, so be sure to use a tripod to hold the camera steady.
- Slow shutter speed also causes slow monitor screen refresh. Because of this, the image recorded may be slightly different from the image that was on the monitor screen when you pressed the shutter button.
- Auto Focus is difficult in the dark. If you experience problems, use manual focusing (page E-64). There may be some blurring of the image if the subject is fast moving.
- The contrast of Night Scene Mode images is not affected by changes made using the REC Menu's Contrast settings (page E-80).

Landscape Mode Recording

The Landscape Mode increases the depth of field to bring everything from nearby objects to faraway objects into focus. It also lets you choose from among five color filters (blue, green, red, yellow, pink) to create exactly the scene you want.

- You may not be able to use the Landscape Mode in combination with the Program AE Mode (P Mode) indoors, outdoors on a cloudy day, etc.
- The effects of the color filters are cancelled out when you are using monochrome or sepia recording, or manual white balance (page E-73, 75).
- Use the monitor screen to compose your images when using the Landscape Mode.

1. Pressing down the Power/Function switch, slide it to REC.
2. Align the dial with .

3. Use [**▼**] and [**▲**] to select the color filter you want.

- Pressing [**▼**] and [**▲**] cycles through the color filters in the following sequence: NORMAL → BLUE → GREEN → RED → YELLOW → PINK.



4. Compose the image and then record it.

Aperture Priority Image Recording

You can select an aperture of F2.6, F4.2, or F6.6. A larger aperture (indicated by a smaller aperture value) narrows the focus range, while a smaller aperture widens the focus range.

Wide aperture



Decreased aperture



Aperture value	Wide ←→ Decreased
	F2.6, F4.2, F6.6

- Adjust the aperture setting to compensate for the relative brightness or darkness of the subject you are recording.

1. Pressing down the Power/Function switch, slide it to REC.
2. Align the dial with A.

3. Use [▼] and [▲] to select the aperture setting you want to use.

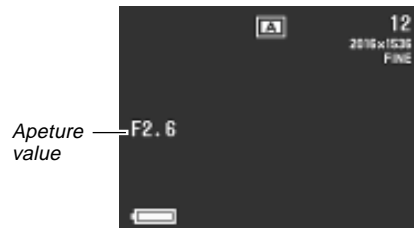

4. Compose the image and then record it.

Manual Exposure Recording

Use the Manual Mode (M Mode) when you want to make your own aperture and shutter speed settings.

- Use the monitor screen to compose your images when using the Manual Mode.

1. Pressing down the Power/Function switch, slide it to REC.
2. Align the dial with M (Manual Mode).
3. Use [▼] and [▲] to select the aperture setting you want to use.
4. Use [▶] and [◀] to change the shutter speed setting you want to use.
5. Compose the image and then record it.

▶▶ IMPORTANT! ◀◀

- You can check your settings by pressing the shutter button about half way down. If the image is either underexposed or overexposed, the aperture and shutter speed settings on the monitor screen turn orange. Though you will be able to record, the resulting image probably will not be the desired brightness. If this happens, you should change your settings before recording the image.
- In the Manual Mode (M Mode), the flash does not fire if Auto Mode or Red-eye Reduction Mode is currently selected as the flash mode.

Monochrome and Sepia Recording

Use the following procedure to record an image in monochrome (black and white) or sepia. Note that you cannot convert an image to color after recording it in monochrome or sepia.

1. Pressing down the Power/Function switch, slide it to REC.
2. Press MENU.
3. Use [▶], [◀], [▼] and [▲] to select “COLOR” and then press SET/Q .
 - On the advanced menu, select “Functions 2” → “Color.”



4. Use [▼] and [▲] to select “B/W” or “Sepia” and then press SET/Q .
5. Compose the image and then record it.

Using the Self-timer





You can use the self-timer for either of the two following recording operations.

10-second recording Records about 10 seconds after the shutter button is pressed. Use this method when you want to be included in the image that is recorded.

2-second recording Records about two seconds after the shutter button is pressed. Use this method to avoid camera movement caused when the shutter button is pressed.

1. Pressing down the Power/Function switch, slide it to REC.

2. Press  .

- Each press of   cycles the self-timer in the sequence: 10SEC () → 2SEC () → Off.

3. Compose the image and then record it.

- The Self-timer lamp flashes with the passage of each second.
- You can cancel a self-timer operation by pressing the shutter button at any time while the Self-timer lamp is flashing.

Performing Manual White Balance

Certain lighting conditions can cause auto white balance to take a very long time or can result in a limitation of the adjustable range (color temperature). If you suspect your current lighting conditions are causing problems, try performing manual white balance. This sets white balance to a level that can be used under any lighting conditions.

The following procedure describes how to perform manual white balance using a white piece of paper. For optimum results, you should use a special reflective plate that should be commercially available from a local camera equipment shop.

- 1. Pressing down the Power/Function switch, slide it to REC.**
- 2. Press MENU.**
- 3. Select “Functions 1” → “White Balance” → “Manual”.**
 - “Functions 1” appears on the advanced menu only.

4. While the camera is pointed at a white sheet of paper or other white surface that fills the entire monitor screen, press DISP to start the manual white balance adjustment operation.

- Advancing to step 5 without pressing DISP in the above step returns the camera to the white balance setting that was obtained the last time you performed the manual white balance procedure.
- The last manual white balance setting obtained is retained in memory, even when you turn off the camera, regardless of the current power on default settings (page E-77). If you change the white balance setting to Auto and then back to Manual, the last manual white balance setting obtained is restored.
- Manual white balance can take a long time to complete where lighting is dim or when you use a dark color. To interrupt an ongoing manual white balance operation and restore the previously set manual white balance setting, press SET/Q.

5. After the manual white balance operation is complete, press SET/Q.
6. Select “Exit”.

»» NOTES ««

- White balance is automatically set to “Daylight” whenever you enter the Night Scene Mode. You can leave this as it is or change it using the above procedure.
- The effects of the Landscape Mode color filters (page E-70) are cancelled out by a manual white balance operation.





Specifying Power On Defaults

A power on default is one that is automatically used by the camera when you turn it on. You can specify power on defaults for focus, flash, metering, white balance, flash intensity, syncro speed and sensitivity.

The following tables show the items for which you can specify power on defaults. Note the following rules concerning power on defaults.

- There are two sets of power on defaults, named Mode 1 and Mode 2.
- When “On” is specified for an item, the camera remembers the current setting for that item when you turn off power, and uses the same setting when you turn power back on again.
- When “Off” is specified for an item, the camera always uses its standard power on default, as shown in the “Off” columns in the tables below.

Mode 1 (Mode Memory 1)

Setting	Available Options	Mode Memory Status	
		On	Off
Focus	AF, MF, ∞, 	Setting at power off	AF
Flash	Auto,  ,  , 		Auto

Mode 2 (Mode Memory 2)

Setting	Available Options	Mode Memory Status	
		On	Off
Metering	Multi, Average, Spot	Setting at power off	Multi
White Balance	Auto, Daylight, Shade, Tungsten, Fluorescent, Manual		Auto
Flash Intensity	Strong, Normal, Weak		Normal
Sync Speed	Fast, Normal, Slow		Normal
Sensitivity	High, Normal		Normal

Turning power on default settings on and off

1. Pressing down the Power/Function switch, slide it to REC.
2. Press MENU.
3. Select “Options”.
 - “Options” appears on the advanced menu only.
4. Select “Mode 1” or “Mode 2”.
5. Select “Mode 1” or “Mode 2”.



6. Select the item whose setting you want to change.
7. Select “On” or “Off”.
 - Repeat steps 6 and 7 for other items if you want.
8. Select “Exit”.

Initializing Power On Defaults and Power Save

Use the following procedure to initialize power on defaults and the power save settings.

►► IMPORTANT! ◀◀

- Note that performing the following procedure to initialize power on defaults also initializes power save trigger time settings (page E-47).

1. Perform steps 1 through 3 under “Turning power on defaults on and off”.
2. Select “Power Save”, “Mode 1” or “Mode 2”.
3. Select “Power Save”, “Mode 1” or “Mode 2”.
4. Select “Restore”.
 - The following table shows the power on defaults status of each item following the above procedure.
5. Select “Exit”.

Item	Initialized Setting
Power Save	
Sleep	1 min
Auto Power Off	2 min
Mode 1 (Mode Memory 1)	
Focus	Off (AF)
Flash	On (Last mode select)
Mode 2 (Mode Memory 2)	
Metering	Off (Multi)
White Balance	Off (Auto)
Flash Intensity	Off (Normal)
Sync Speed	Off (Normal)
Sensitivity	Off (Normal)

Using the REC Menus

The REC menus make it easy to control image quality, white balance, and other settings to suit specific conditions and preferences. Each REC menu has two formats: a basic menu and an advanced menu. Press DISP to toggle between the basic menu and advanced menu.

NOTE

- Focus, Flash, Metering, White Balance, Flash Intensity, Sync Speed and Sensitivity settings are retained when camera power is turned off by only if you specify them as power on defaults (page E-76). All other settings are retained when you turn off camera power.

REC Menus

See “Menu Screens” on page E-34 for information about how to use menus.

Basic menu items are indicated by **BASIC**.

OTHER RECORDING FUNCTIONS

Picture

Quality

BASIC

Use this setting to control the quality of the image.
Fine / Normal / Economy

Size

BASIC

You can specify either of two image sizes in pixels.
2016 x 1536 / 1008 x 768

Sharpness

This setting specifies the sharpness of image outlines.

- Hard : Sharp outlines
- Normal
- Soft : Soft outlines

Saturation

This setting controls the intensity of colors.

- High : Colors appear deeper.
- Normal
- Low : Colors appear lighter.

Contrast

This setting controls the difference between the light areas and dark areas of the image. Contrast is not applied in the Night Scene Mode.

- High : Larger difference between light and dark.
- Normal
- Low : Less difference between light and dark.

Functions 1

Drive Mode

BASIC

This setting specifies how the shutter operates.

- Single : Allows recording of five images at an interval of about 2.5 seconds.
- Continuous : Allows recording of sequential images at an interval of about 1 second while the shutter button is held down (when the monitor screen is turned off).
- AEB : Records three versions of the same image with different EV settings.

- With any of the above settings, the interval may be longer at slow shutter speeds.
- The interval may also be longer when battery power is low and when you are using a microdrive for storage.

Metering

This setting sets the metering method.

- Multi : Takes readings across the entire image, and provides balanced exposure settings.
- Average : Takes an average reading of the entire screen.
- Spot : Takes reading at a very limited spot at the center of the image. Peripheral lighting does not affect this reading, so exposure is based on the subject alone.



White Balance	<p>Use this setting to select the white balance setting that makes the colors of the subject appear most natural. (Auto / Daylight / Shade / Tungsten /Fluorescent/ Manual)</p> <p>Daylight : Outdoors Shade : Blue tinted sunlight Tungsten : Red tinted incandescent light Fluorescent : Green tinted fluorescent light Manual : Sets up the camera for recording of a white sheet of paper under currently available light (page E-75).</p>
----------------------	--

Flash Intensity	<p>Select the setting for the flash intensity you want to use. Strong / Normal / Weak</p>
------------------------	---

Sync Speed	<p>Select the sync speed you want to use. Fast / Normal / Slow</p>
-------------------	--

Sensitivity	<p>Select the sensitivity level. High / Normal</p> <ul style="list-style-type: none"> • This setting is disabled and standard settings are used in the case of flash and manual recording. • Higher sensitivity can increase the chance of noise in the image. • Higher sensitivity can make it difficult to obtain proper focus using Auto Focus. It does not change the minimum brightness required for Auto Focus. • Use of the flash automatically employs the "Normal" sensitivity setting.
--------------------	--

Functions 2

Movie Mode	<p>Select the movie mode you want to use. Normal / Past</p>
-------------------	---

Color BASIC	<p>Use this setting to select the color mode you want. Color / B/W / Sepia</p>
------------------------------	--

Grid	<p>This item turns an on-screen grid on or off. The grid can be used to help align image components vertically and horizontally. Off / On</p>
-------------	---

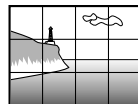

Time Stamp BASIC	<p>Use this item to turn time stamping on and off, and to control the format of the stamp. Off / YMD (Year-Month-Day) / D H:M (Day-Hour-Minutes) / YMD H:M (Year-Month-Day-Hour-Minutes) Note that the time stamp cannot be deleted from an image.</p>
-----------------------------------	--

OTHER RECORDING FUNCTIONS

Options

Power Save	This item can be used to make power save settings to preserve battery power. Sleep (Off / 30sec / 1min / 2min) / Auto Power Off (2min / 5min)
Mode 1	Use this item to specify which of the following settings are retained when camera power is turned off. Focus / Flash
Mode 2	Use this item to specify which of the following settings are retained when camera power is turned off. Metering / White Balance / Flash Intensity / Sync Speed / Sensitivity

Set Up

Card Browser BASIC	Use this item to select the Card Browser file type. Off / Type1 / Type2 / Type3 / Type4
Format BASIC	Select this item to format a memory card. No / Yes
Date BASIC	Use this item to specify the format of the date that appears in the monitor screen, and to adjust the date setting. Style (Year/Month/Day / Day/Month/Year / Month/Day/Year) / Adjust
Video Out BASIC	This item can be used to specify the format of the video output signal. NTSC: Video format in the United States and Japan PAL: Video format in Europe and other areas
Language BASIC	This setting lets you select either English or Japanese as the display language.
Beep BASIC	Use this item to turn the key input confirmation tone off and on.

PLAYBACK

The following describes the different techniques that you can use to playback recorded images.

Basic Playback Operation

The built-in monitor screen of the camera lets you play back recorded images without connecting an external monitor.

1. Pressing down the Power/Function switch, slide it to PLAY.



2. Use [▶] and [◀] to scroll through the images stored in camera memory.

- Press [▶] to scroll forward and [◀] to scroll back. Holding down either button scrolls at high speed.



NOTES

- If you hold down the Power/Function switch and slide it to PLAY immediately after you record an image, the image is immediately stored in memory.
- The image that initially appears on the monitor screen in the PLAY mode is a preview image. The full image appears after four seconds. Images copied from another digital camera or a computer may take longer time to appear.

Playing Back a Movie

Use the following operation to play back a movie that was recorded using the operation under "Movie Recording" on page E-66.

1. Pressing down the Power/Function switch, slide it to **PLAY**.
2. Use [▶] and [◀] to select the movie you want to play back.



3. Press SET/Q to start playing back the movie.

- You can use [▶] (forward) and [◀] (reverse) while playing back a movie to change the playback direction.
- To enlarge the movie image so it fills the entire monitor screen, press DISP. Pressing the DISP again returns the image to its original small size.
- Pressing SET/Q during movie play pauses playback. Press SET/Q again to resume playback.
- While movie playback is paused, you can use [▶] (forward) and [◀] (reverse) to move frame-by-frame through the movie.

4. After the movie is complete, press MENU.

Panorama Playback

Use the following operation to playback panoramas recorded using the operation under "Panorama Recording" on page E-68.

1. Pressing down the Power/Function switch, slide it to **PLAY**.
2. Use **[▶]** and **[◀]** to select the panorama you want to play back.



3. Press SET/Q to start panorama playback.

- You can change the direction of a panorama that is playing back by pressing **[▶]** or **[◀]**.
- Pressing **DISP** changes to a small-image display. Press **DISP** again to return to the full-screen size.
- Pressing **SET/Q** during panorama play pauses playback. Press **SET/Q** again to resume playback.
- While panorama playback is paused, you can use **[▶]** (forward) and **[◀]** (reverse) to move frame-by-frame through the panorama.

4. Press MENU to stop panorama playback.

Zoom the Playback Image

You can enlarge the playback image to one of six steps.

Zoom Factors (Steps): 1.2, 1.6, 2, 2.4, 2.8, 3.2

▶▶ IMPORTANT! ◀◀

- You cannot enlarge a movie or panorama playback image.

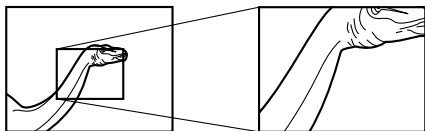

- Pressing down the Power/Function switch, slide it to PLAY.
- Use [▶] and [◀] to display the image you want to enlarge.
- Press SET/Q to enter the Digital Zoom Mode.
 - This causes a view frame and the current factor to appear on the monitor screen.
 - You can exit the Digital Zoom Mode by pressing MENU.



- Press SET/Q to cycle through the zoom factors.
- Use [▶], [◀], [▼], and [▲] to shift the view frame to different parts of the image.
- When the view frame is located at the part of the image you want to enlarge, press DISP to enlarge it.
- Press SET/Q to return the image to its normal size.

Displaying Other Image Information





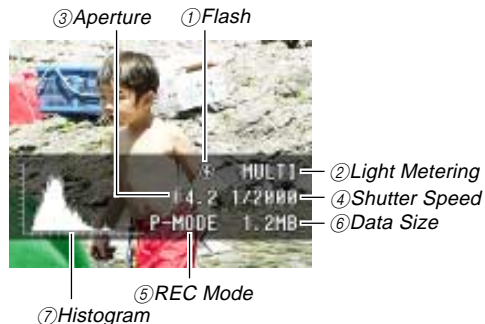

The camera saves other information in addition to the image itself. Use the following procedure to view this other information.

1. Pressing down the Power/Function switch, slide it to PLAY.

2. Press $\frac{1}{2}$ INFO.

- This displays the image information shown below on the monitor screen.



①Flash	<ul style="list-style-type: none">  : Flash on  : Flash off  : Red eye reduction
②Light Metering	<ul style="list-style-type: none"> MULTI : Multi-metering AVG : Average metering SPOT : Spot metering
③Aperture	
④Shutter Speed	
⑤REC Mode	<ul style="list-style-type: none"> M-MODE : Manual Mode A-MODE : Aperture Priority Auto Mode P-MODE : Program AE Mode  : Night Scene Mode  : Landscape Mode  : Movie Mode  : Panorama Mode
⑥Data Size	
⑦Histogram	<p>Use the histogram to check exposure when recording.</p> <ul style="list-style-type: none"> Exposure conditions indicated by the histogram may not be accurate when using the flash, when using multi-metering, or under certain other conditions.

PLAYBACK

- Except for the Histogram, “-----” is shown in place of any item for which information is uncertain or otherwise unavailable.

3. Use [▶] and [◀] to scroll through the images.

- It may take some time for the image data to appear after you select an image.
- Pressing ⚡ INFO again returns to the PLAY mode.

▶▶ NOTE ◀◀

- In the case of a movie or panorama, image information is displayed on the first image only.



Displaying Nine Images

The following operation lets you simultaneously view nine images on the same screen. This capability is especially useful when playing back to the screen of a connected TV, and can be used to display a catalog of products, etc.



1. Pressing down the Power/Function switch, slide it to PLAY.
2. Press MENU.
3. Select “9 MULTI”.
 - The first image of the set is the image that was on the screen when you performed step 2 of this operation. The other images are those that sequentially follow the first one.

4. Use [▶] and [◀] to scroll through images stored in memory.

- To view a particular image in normal size, press DISP. This causes the  mark to appear in the upper left corner of the monitor screen. To produce an enlarged view of an image, use [▶], [◀], [▼] and [▲] to move the  mark to the image you want and then press SET/Q.

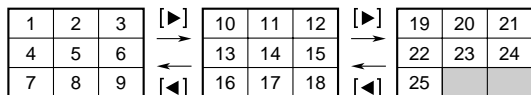

5. After you are finished, press any button besides [▶], [◀], or DISP to return to the normal single-image display.

Slide Show

Slide Show automatically scrolls through the images stored in memory. You can also specify how much time should be allowed between each image.



▶▶ IMPORTANT! ◀◀

- Auto Power Off (page E-44) is disabled whenever Slide Show is being used. This means you should not leave Slide Show running when using batteries to power the camera. Doing so can rundown batteries. Be sure to stop Slide Show and turn off the camera after you are finished.

1. Pressing down the Power/Function switch, slide it to **PLAY**.
2. Press **MENU**.
3. Select “**SLIDE SHOW**”.
4. To stop Slide Show, press any button besides **MENU**.
 - Pressing **MENU** while a Slide Show is in progress displays a screen that lets you change the interval within the range of 5 to 30 seconds.
 - Images copied from another digital camera or a computer may take longer time to appear.

Using the PLAY Menus

The PLAY menus provide you with control over the display format and DPOF settings, image delete and save operations, and other settings. The PLAY mode has only one menu format (basic). It does not have an advanced menu like the REC mode.

PLAY Menus

See “Menu Screens” on page E-34 for information about how to use menus.

9 MULTI	Display nine images on the monitor screen.
SLIDE SHOW	Automatically scrolls through the images one-by-one.
PROTECT	Use this item to protect images against deletion. Select : Protects a single specific image. Folder : Protects all images in a specific folder. All : Protects all images.

DPOF	<p>Use this item to specify images for printing on a DPOF printer.</p> <p>Select : Prints a single specific image.</p> <p>Folder : Prints a specific number of copies of all images in a specific folder.</p> <p>All : Prints a specific number of copies of all images.</p>
DELETE	<p>Use this item to delete images.</p> <p>Select : Deletes a single specific Image.</p> <p>Folder : Deletes all unprotected images in a specific folder.</p> <p>All : Deletes all unprotected images.</p>
SET UP	<p>Card Browser Use this item to select the Card Browser file type. Off/ Type1 / Type2 / Type3 / Type4</p> <hr/> <p>Format Select this item to format a memory card.</p> <hr/> <p>Date Use this item to specify the format of the date that appears in the monitor screen, and to adjust the date setting. Style(Year/Month/Day / Day/Month/Year / Month/Day/Year) / Adjust</p>

SET UP	<p>Video Out This item can be used to specify the format of the video output signal.</p> <p>NTSC : Video format in the United States and Japan</p> <p>PAL : Video format in Europe and other areas</p>
	<p>Language This setting lets you select either English or Japanese as the display language.</p>
	<p>Beep Use this item to turn the key input confirmation tone off and on.</p>

FOLDER TYPES

Memory Card Folder Precautions

The camera automatically creates folders (directories) on the memory card and assigns them names based on dates (month and day). Any image you record is automatically stored into the folder that corresponds to the date it is recorded.

- Up to 900 folders can be created on a single card. The following shows a typical folder name.

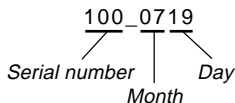

- Up to 250 image files can be stored in each folder. The following shows a typical file name.

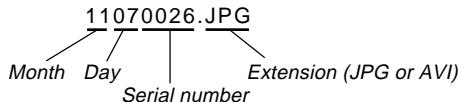

- When you try to save the 251st image to a folder, the camera automatically creates a new folder and store the image there.
- The above maximum numbers of files and folders are absolute maximums. The actual numbers of folders and files may be less due to memory card capacity and the size of each image.
- Panorama images are divided into multiple images and stored on the memory card.
- See “USING CompactFlash CARDS WITH YOUR COMPUTER” on page E-108 for information about how files and folders are organized.
- If there are more than 250 image files in a folder (due to copying from another digital camera or a computer), only the first 250 (in name sequence) can be played back.

Selecting a Folder for Playback

1. Pressing down the Power/Function switch, slide it to PLAY.
2. Press MF/∞/🌿📁.
3. Use [▶] and [◀] to select the folder you want to select for playback.



4. Press SET/Q to playback the first image in the folder.

IMAGE PROTECTION

Use the following operations when you want to protect images against accidental deletion. A protected image cannot be deleted until it is unprotected. You can protect and unprotect a single specific image, all the images in a particular folder, or all images currently on the memory card.

▶▶ IMPORTANT! ◀◀



- Formatting a memory card (page E-38) deletes all images on the card, even if some or all of the images are protected.

Protecting and Unprotecting a Single Image



1. Pressing down the Power/Function switch, slide it to PLAY.
2. Press MENU.
3. Select "PROTECT" → "Select".

4. Select the image you want to protect.



5. Press [▼] or [▲] to toggle the  mark of the selected image on and off.
 - Selected images are indicated by .
 - Repeat step 4 to select other images if you want.
6. After all the images you want to protect are selected, press SET/Q to protect them.



Protecting Folders

1. Pressing down the Power/Function switch, slide it to PLAY.
2. Press MENU.
3. Select "PROTECT" → "Folder".
4. Use [▶] and [◀] to select the folder you want to protect.
5. Press [▼] or [▲] to toggle the  mark of the selected folder on and off.
6. Press SET/Q .
 - The  mark in the upper left corner of an image when image information is turned on indicates it is protected.

»» IMPORTANT! ««

- The above procedure batch protects each of the images in the folder. There is no procedure for batch unprotecting the contents of a folder. Each image must be unprotected one-by-one.

Protecting and Unprotecting All Images on a Memory Card

1. Perform steps 1 through 2 under "Protecting and Unprotecting a Single Image".
2. Select "PROTECT" → "All".
3. Select "Protect" or "Unprotect".
 - The  mark in the upper left corner of an image when image information is turned on indicates it is protected.
 - The  mark does not appear when an image is not protected.



DELETING IMAGES

Use the following operations when you want to delete images. You can delete the currently selected image, specifically selected image, all the images in a particular folder or all images currently on the memory card.

▶▶ IMPORTANT! ◀◀

- Image deletion cannot be undone. Before deleting an image, make sure you no longer need it or you have a back-up copy saved on your computer, on diskette, or on some other medium.
- Be especially careful with “Deleting All Unprotected Images” (page E-99) operation, which deletes all unprotected images in memory.
- A protected image cannot be deleted. See “Image Protection” on page E-94 for details on protecting and unprotecting images.

Deleting the Currently Selected Image

- 1. Pressing down the Power/Function switch, slide it to PLAY.**
- 2. Use [▶] and [◀] to display the image you want to delete.**
- 3. Press  .**
 - You can still use [▶] and [◀] to change to another image as this point, if you want.
- 4. Use [▼] to select “Yes”.**
 - To cancel the delete operation, select “No” and then press SET/Q, or press any other button besides [▶], [◀], [▼], [▲], or SET/Q.
- 5. Press SET/Q .**
 - Deleting a panorama deletes all of the images that make it up as well.

NOTE

- The camera does not maintain open spaces in its memory. Deleting an image causes all images following the deleted image to be shifted up.

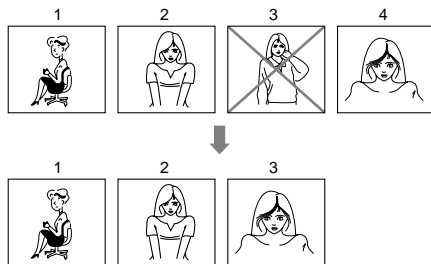

Deleting a Single Image

- Pressing down the Power/Function switch, slide it to **PLAY**.
- Press **MENU**.
- Select **"DELETE"** → **"Select"**.
- Select the image you want to delete.



- Protected images are not displayed.
- Note that the first time you display an image its  mark is turned on.

5. Press [▼] or [▲] to toggle the  mark of the selected image on and off.
 - If you want to delete more than one image, repeat steps 4 and 5.
6. After all the images you want to delete are selected, select “Yes” to delete them or “No” to abort the delete operation without deleting anything.
 - Deleting a panorama deletes all of the images that make it up as well.

Deleting All the Images in a Folder

1. Pressing down the Power/Function switch, slide it to .
2. Press MENU.
3. Select “DELETE” → “Folder”.
4. Use [▶] and [◀] to select the folder you want to delete.
5. Press [▼] or [▲] to toggle the  mark of the selected folder on and off.
6. Select “Yes” to delete the contents of the folder, or “No” to abort the delete operation without deleting anything.
 - When the above procedure is performed while there are protected images in memory, the first of the protected images appears on the monitor screen after the unprotected images are deleted.

Deleting All Unprotected Images



1. Pressing down the Power/Function switch, slide it to PLAY.
2. Press MENU.
3. Select “DELETE” → “All”.
4. Select “Yes” to delete all unprotected images, or “No” to abort the delete operation without deleting anything.
 - When the above procedure is performed while there are protected images in memory, the first of the protected images appears on the monitor screen after the unprotected images are deleted.

DPOF

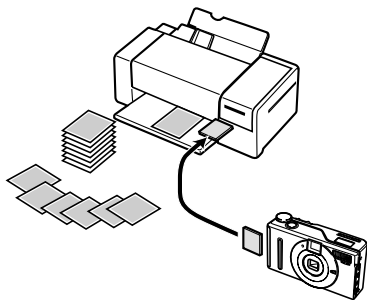
The letters “DPOF” stand for “Digital Print Order Format,” which is a format for recording on a memory card or other medium which digital camera images should be printed and how many copies of the image should be printed. DPOF makes it possible for a DPOF compatible printer or professional print service to print images from a memory card without having to specify individual file names.



Printing Specific Images

1. Pressing down the Power/Function switch, slide it to PLAY.
2. Press MENU.
3. Select “DPOF” → “Select”.
4. Use [▶] and [◀] to select the image you want to print.
5. Press [▼] or [▲] to toggle the  mark on (print) or off (do not print).
 - With this procedure, you can turn the  mark on and off for each individual image.



6. Use [▼] and [▲] to specify the number of copies you want to print.



- If you want to specify more images for printing, repeat steps 4 through 6.
- If you change your mind about printing an image, press [▼] to clear its  mark.

7. After you are finished, press SET/Q to exit the image specification procedure.

Printing All the Images in a Folder

- 1. Pressing down the Power/Function switch, slide it to PLAY.**
- 2. Press MENU.**
- 3. Select “DPOF” → “Folder”.**
- 4. Use [▶] and [◀] to select the folder you want to print.**
- 5. Press [▼] or [▲] to toggle the  mark on (print) or off (do not print).**
- 6. Use [▼] and [▲] to specify the number of copies of each image you want to print.**
- 7. Press SET/Q .**

▶▶ IMPORTANT! ◀◀

- If the folder you select for printing already contains images whose  mark is turned on (print), selecting the folder using the above procedure can cause the  mark to turn off (do not print) for those images. After performing the above procedure, it is a good idea to check the images in the folder to make sure none of their  marks were turned off.

Printing All Images

1. Pressing down the Power/Function switch, slide it to PLAY.
2. Press MENU.
3. Select “DPOF” → “All” → “Set print order”.
 - To cancel current print settings, select “Cancel print order”.
4. Press SET/Q.
5. Use [▼] and [▲] to specify the number of copies of each image you want to print.



6. After you are finished, press SET/Q to exit the image specification procedure.

- The above procedure causes the  mark to appear on all the images in memory.

CONNECTIONS

This camera is equipped with a VIDEO OUT terminal for connection to a television or video deck, and a DIGITAL terminal and USB port for connection to a computer or other equipment.

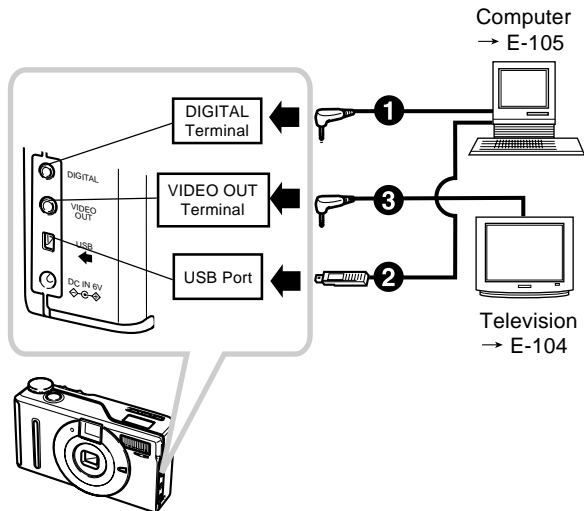

❶ Cables

The type of cable you should use depends on the type of equipment to which you are connecting.

❷ Special USB cable

When connecting to a computer, use the special USB cable and USB driver software that comes with the camera.

❸ Special video cable that comes with camera

ⓘ IMPORTANT! ⓘ

- Be sure to turn off both the camera and other equipment before making any connections.
- Check the documentation that comes with your other equipment for information you may need to know when making connections.
- Leaving the same image displayed on a television or computer display screen for very long periods can cause the image to be “burned in” on the screen. When this happens, a faint after-image remains on the screen, even after you disconnect the camera. To avoid this, you should not leave the same image displayed on such a screen for very long periods.
- This camera does not support cable transfer of data with other CASIO digital cameras.

CONNECTING TO OTHER EQUIPMENT

Connecting to a Television

Images being displayed on the camera's monitor screen, whether for recording or playback can also be displayed on the screen of a connected television.

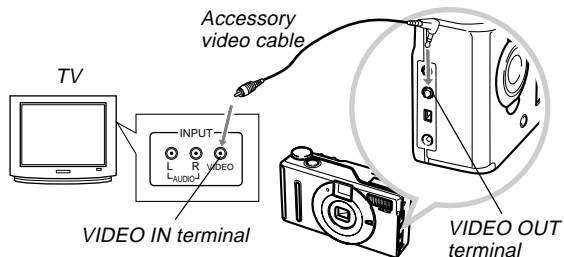

- 1. Connect one end of the video cable to the camera and the other end to the television.**
- 2. Set up the television for video input.**
 - See the documentation that comes with the television for information about how to do this.
- 3. The connection procedure is the same for both recording and playback.**

▶▶ IMPORTANT! ◀◀

- A television must have a video input terminal like the one shown in the illustration to connect to this camera.
- Battery capacity (page E-31) and other displays that normally appear on the camera's monitor screen are also displayed on the television screen.

Selecting the Video Output Signal Mode

You can select either of two common video output modes: NTSC or PAL.

The video system you should use depends on the country where you plan to use the output signal. In the United States or Japan, for example, you should use NTSC, but in Europe you need to use PAL.

Check with your local video or TV retailer if you are unsure about which video mode you should use in your country.

- 1. Press MENU.**
- 2. Select "SET UP" → "Video Out".**
- 3. Select the video mode you want to use.**

Connecting to a Computer

The following accessories are included with the camera to make it easy for you to connect to a computer to transfer and manage your images.

- USB cable
- USB driver software (on CD-ROM)
- Data Transfer Cable
- Photo Loader application (on CD-ROM)

USB Port Connections

The camera's USB port and accessories make it easy to connect to a computer equipped with a USB port. First install the USB driver software that comes bundled with the camera on your computer, and then use its special USB cable to make the connection. Once connected, you can view images on your computer's display and store images on its hard disk.

- See the separate installation manual for information about how to install the driver software on your computer.

System Requirements

Windows	Macintosh
<ul style="list-style-type: none"> • IBM PC/AT or compatible computer pre-installed with Windows Me/98 or upgraded from Windows 98 to Windows 2000/Me • 486 or higher CPU (Pentium recommended) • CD-ROM drive (for installation) • Keyboard and mouse or equivalent input device • USB port <p>* Operation is not guaranteed under the following conditions.</p> <ul style="list-style-type: none"> • A computer upgraded from Windows 95 or Windows 3.1 to Windows Me/98 • A computer upgraded from Windows 95 or Windows NT to Windows 2000 <p>* Operation under Windows 95/3.1 or Windows NT is not supported.</p> <p>* In the case of Windows 2000, proper operation is guaranteed for Windows 2000 Professional only.</p> <p>* The USB driver may not run correctly under certain system configurations.</p>	<ul style="list-style-type: none"> • Mac OS 8.5 or higher, Mac OS 8.1 with USB system extensions (iMac Update 1.0 is required) • Power PC G3 • CD-ROM drive (for installation) • Keyboard and mouse or equivalent input device • Available USB port

* The USB driver may not run correctly under certain hardware configurations.

USB Port Connection

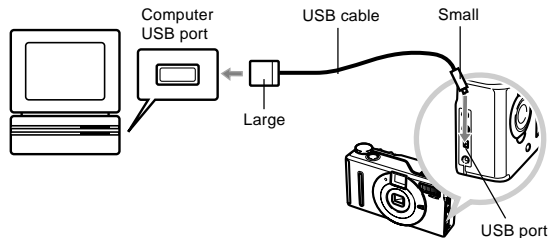

▶▶ IMPORTANT! ◀◀

- Whenever connecting the USB cable to the camera, make sure the arrow mark on the plug is aligned properly with the arrow mark on the side of the camera's terminal.
- Plug the USB connectors into the ports as far as they will go. Incorrect connection can result in improper operation.
- The camera is not supplied power by the USB cable. Be sure to use the AC adapter to power the camera whenever using a USB cable connection.
- Never disconnect the USB cable while a data communication operation is in progress. Doing so can corrupt memory data.

- Connecting the camera to a computer with the USB cable causes the "USB" to appear in the camera's indicator display. This simply means that the cable is connected but does not mean that the camera is being recognized by the computer as an external storage device. Perform the required operation on your computer to check whether the camera is being recognized by the computer as an external storage device.
- USB data communication becomes enabled whenever you connect the USB cable, regardless of whether the camera is in the PLAY mode or REC mode.
- Disconnect the USB cable after you are finished with data communication.
- You cannot turn off the camera while the USB cable is connected. Disconnect the USB cable first when you want to turn off the camera.

Data Transfer Cable Connection

You can use the Data Transfer Cable to connect to your personal computer through the camera's DIGITAL terminal. Then you save images on your computer's hard disk using the Photo Loader application.

- See the separate installation manual for information about how to install Photo Loader on your computer.

Windows 2000, Me, 98, 95, NT Workstation 4.0

The Data Transfer Cable can be connected to an IBM PC/AT or compatible that is equipped with a D-Sub9 RS-232C terminal.

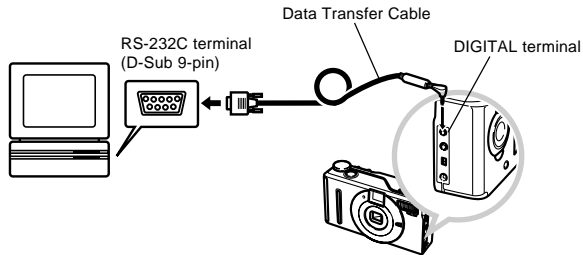

Macintosh

Connection of the Data Transfer Cable and operation of the Photo Loader application is not supported on an Apple Macintosh.

▶▶ IMPORTANT! ◀◀

- See the documentation that comes with Photo Loader for information about system requirements.
- Be sure to turn off the camera, computer, and all peripherals (monitor, disk driver, etc.) connected to the computer before connecting the digital camera with the Data Transfer Cable.
- After connecting the camera to the computer, pressing down the Power/Function switch, slide it to PLAY and then turn on the computer. Note that data communication with a computer is not possible while the Power/Function switch is in the REC position.
- Never connect or disconnect the cable while Photo Loader is running. Doing so can cause problems with program execution, can corrupt data, and can damage the camera and your computer.
- Data transfer while camera batteries are low can result in sudden shutdown of the camera. Because of this, use of the optional AC adapter is recommended whenever performing data communication with the camera.
- This camera does not support data communication with any of the optionally available CASIO PC link software applications: LK-1, LK-1A, LK-10V, LK-11W, LK-2, LK-2A, LK-2V, LK-21.

USING CompactFlash CARDS WITH YOUR COMPUTER

Setting Up to Access CompactFlash Card Contents From Your Computer

You can use any of the three methods described below to access the contents of a memory card with your computer. You can use the Photo Loader software to save images on the memory card to your computer.

CompactFlash Memory Card Slot

If your computer has a CompactFlash Memory Card Slot, insert the camera's memory card into the slot.

PC Card Slot

In this case you need an optionally available CASIO CA-10 PC Card Adapter. See the instructions that come with the PC Card Adapter and the documentation that comes with your computer for details on using this type of configuration.

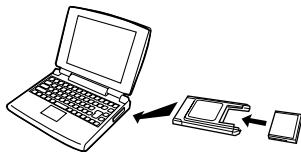

Other Desktop Computer Configurations

Some desktop computers require a separately available PC card reader/writer and the optionally available CASIO CA-10 PC Card Adapter to read memory card contents. See the instructions that come with the PC card reader/writer and the PC Card Adapter for details on using this type of configuration.

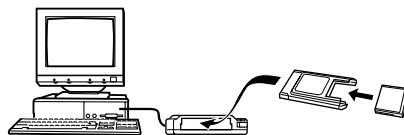

Memory Card Data

Images recorded with this camera and other data is stored on the memory card using DCF (Design rule for Camera File system) protocol. DCF protocol is designed to make it easier to exchange image and other data between digital cameras and other devices.

DCF Protocol

DCF devices (digital cameras, printers, etc.) can exchange images with each other. DCF protocol defines the format for image files data and the directory structure for the memory card, so images can be viewed using another manufacturer's DCF camera or printed on a DCF printer.

In addition to support for the DCF protocol, your CASIO digital camera also shows dates in image folder names and image file names, which helps to make data management easier.

CompactFlash Card Directory Tree

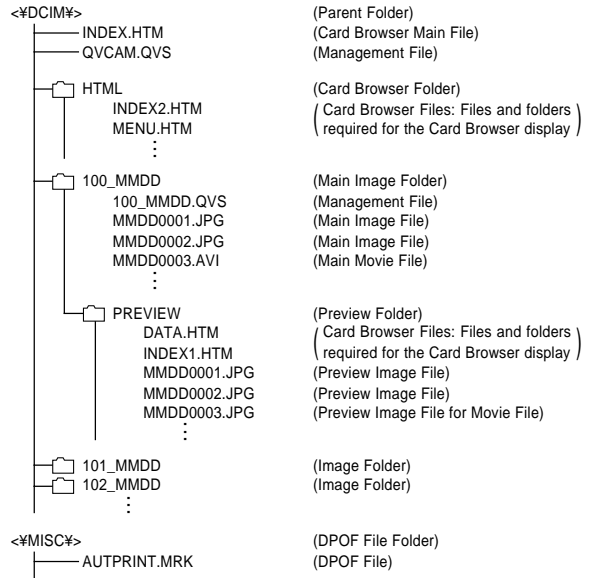

Folder and File Contents

- Parent Folder
Contents: All files used by the digital camera
- Card Browser Main File
Contents: Template for card browser, which is used for viewing image previews with a web browser
- Management File
Contents: Information about folder management, image sequence, etc.
- Card Browser Folder
Contents: Files used by the card browser
- Card Browser File
Contents: Data used by the card browser
- Main Image Folder
Contents: Image files recorded by the camera
- Main Image File
Contents: Still image file recorded by the camera
- Main Movie File
Contents: Movie file recorded by the camera
- Preview Folder
Contents: Preview images

- Preview Image File
Contents: Preview images of still image and movie files used for temporary playback and card browser previews
- DPOF File Folder
Contents: DPOF files
- DPOF File
Contents: Printer data

Image Files Supported by the Camera

- Image files recorded with the CASIO QV-3EX Digital Camera
- DCF protocol image files
Certain DCF functions may not be supported.

Personal Computer

- This camera uses management files to manage the sequence and attributes of image files. Because of this, adding files, deleting files, changing management file contents, or changing file sequence and attributes with your computer can cause panorama images to become ungrouped. It can also result in slower image scrolling on the camera.
- When transferring CompactFlash card contents to a hard disk, floppy diskette, MO disk, or other external storage, keep everything in the DCIM folder together. Changing the name of the DCIM folder to a date is a good way to keep track of your images. However, be sure to change the name of this folder back to DCIM if you ever copy it back to the memory card for playback on the camera. This camera does not recognize any folder name besides DCIM.
- The above is also true about the names of folders inside the DCIM folder. These folders must be returned to the names assigned to them by the camera whenever you copy the DCIM folder back to the memory card for playback on the camera.
- Never delete or modify the QVS file in any way.
- We also strongly recommend that after transferring data from a CompactFlash card to other external storage that you re-format the card and delete its contents before using it to record more images.

Card Browser

Card Browser makes it possible to use a browser application to view images recorded with the QV-3EX.

- The HTML file generated by this camera is best viewed using Microsoft Internet Explorer 4.01 or later, or Netscape Communicator 4.5 or later. It cannot be viewed using Photo Loader.
- QuickTime is required to play back AVI movie files.

1. Press MENU.

2. Select “SET UP” → “Card Browser”.



3. Use [▼] and [▲] to select the Format and then press SET/Q .

There are four Card Browser formats.

Type1.....This is a powerful format that provides detailed information about each image and also includes a Slide Show feature.

Type2.....This format is a viewer with a Slide Show feature.

Type3.....This format shows information about each image. You should be able to use it with any browser, regardless of version.

Type4.....This format provides basic image viewing. Since it is the simplest option, you should be able to use it with just about any browser, regardless of version.

- Note that the Type1 and Type3 formats use Java Script, so their use requires Microsoft Internet Explorer 4.01 or later, or Netscape Communicator 4.5 or later.
- Turning on Card Browser causes an HTML file to be generated whenever you turn off camera power.
- Selecting "Off" in step 3 of the above procedure turns off Card Browser.
- Creation of an HTML file causes an INDEX.HTM file and other files to be added to the DCIM folder.

»» NOTE ««

- Pressing DISP in place of SET/Q in step 3 immediately starts Card Browser file generation, which is indicated by the message "One moment please..." on the monitor screen. Never turn off camera power while this message is on the display.

»» IMPORTANT! ««

- Though the camera's monitor screen goes blank when you turn off power, the Power/Function lamp or Operation lamp continues to flash for some time as the camera internally generates a Card Browser file (when Card Browser is turned on). Performing any of the operations while the Power/Function lamp or Operation lamp is flashing not only stops generation of the Card Browser file, it can also result in corruption of the image data on the CompactFlash Card. Note that a Card Browser file may be corrupted if batteries are low or if the CompactFlash Card becomes full during file generation.
- If the CompactFlash card in the camera has a large number of files on it, it may take quite a bit of time for the camera to generate the required HTML files and actually turn off after you hold down the Power/Function switch and slide it to OFF. Because of this, we recommend that you normally leave Card Browser turned off, except when you actually want to generate HTML files.

- This camera generates a Card Browser file whenever you turn off power. When the card in the camera contains a large number of files, it may take some time for the file generation operation to be performed. You can turn off the Card Browser feature if you do not want a file generated each time you turn off camera power.

How to use the HTML file

Viewing HTML File Contents

Load the CompactFlash card into a card slot of your computer (page E-106). Now drop the INDEX.HTM file (in the DCIM folder) onto your Web browser to display a list of all images contained on the CompactFlash card.

For information about importing data from a memory card, see “Setting Up to Access CompactFlash Card Contents from Your Computer” (E-108) and “Connecting to a Computer” (E-105).



Folder name

Image

File name

Clicking on a folder name displays the following data about the images contained in the folder.



Image Information

File size (KB)
Resolution (pixels)
Quality
Recording mode
AE
Light metering
Shutter speed
Aperture stop
Exposure comp
Focusing mode
Flash mode
Sharpness
Saturation
Contrast
White balance
Digital zoom
Date
Model

Click Index to return to the image list.

Saving an HTML File

- You can use the Photo Loader application that comes bundled with the camera to easily save the images in the HTML file to a computer. See the documentation that comes with Photo Loader for details.
- Before using the CompactFlash card again (after storing its images on other media), delete all its current files or reformat the card.
- In the case of Type1 and Type3, Slide Show displays 1008 x 768 size images in the same size as 2016 x 1536 images.
- The index screen uses the contents of the Preview Folder (page E-109). Images copied from another digital camera or a computer may not have preview images, and so they do not appear in the index screen. If this happens, scroll through the images on the monitor screen until the copied images appear. At this time, the camera automatically generates a preview image, which will now appear on the Card Browser index screen.

TROUBLESHOOTING

	Symptom	Probable Cause	Action
Power Supply	No power	<ol style="list-style-type: none"> 1. Battery not loaded correctly. 2. Dead battery 3. Wrong AC adapter 	<ol style="list-style-type: none"> 1. Correctly load a battery (page E-41). 2. Replace the battery with a new one (page E-41). 3. Use only the specified AC adapter or AC adapter/charger.
	Sudden power failure	<ol style="list-style-type: none"> 1. Auto Power Off 2. Low battery power 	<ol style="list-style-type: none"> 1. Turn power back on. 2. Replace the battery with a new one (page E-41).
	 indicator on LCD	Battery is about to go dead.	Replace the battery with a new one (page E-41).
Recording	No recording when shutter button is pressed	<ol style="list-style-type: none"> 1. The Power/Function switch is in the PLAY position. 2. Flash unit is charging. 3. The message "MEMORY FULL" is on the monitor screen. 4. Insufficient memory card capacity or no memory card loaded in camera. 	<ol style="list-style-type: none"> 1. The Power/Function switch is in the REC position. 2. Wait until flash unit charging is finished. 3. Delete images you no longer need from camera memory. 4. Load a memory card.
	Auto Focus cannot focus the image.	<ol style="list-style-type: none"> 1. Lens is dirty. 2. The object you want to focus is not in the focus frame. 3. Conditions make it impossible to obtain proper focus. 4. Camera is unsteady or shaking. 	<ol style="list-style-type: none"> 1. Clean off the lens. 2. Aim the camera so the object you want to focus is in inside the focus frame. 3. Switch to the Manual Mode and focus manually. 4. Use a tripod to steady the camera.

TROUBLESHOOTING

	Symptom	Probable Cause	Action
Recording	The recorded image is out of focus.	The focus setting is not correct.	Make sure the subject you want to focus is within the Auto Focus Frame when you record the image.
	Power failure during self-timer operation	Low battery power	Replace the battery with a new one (page E-41).
	Monitor screen image is out of focus.	<ol style="list-style-type: none"> 1. Failure to focus the image while the camera is in the Manual Focus Mode. 2. Attempting to record scenery or portraits in the Macro Mode. 3. Attempting to use the Auto Focus while the subject is within 50cm of the camera. 	<ol style="list-style-type: none"> 1. Focus the image before recording it. 2. Use the Program AE Mode (P Mode) for scenery and group shots. 3. Use the Macro Mode for close ups.
	Poor color and brightness when indoors	Indoor fluorescent lighting	Shoot under incandescent or other non-fluorescent lighting (page E-53).
	Cannot perform movie recording.	<ol style="list-style-type: none"> 1. Movie Record Mode is not selected. 2. Insufficient camera memory capacity. 	<ol style="list-style-type: none"> 1. Select the Movie Record Mode (page E-66). 2. Delete images you no longer need from camera memory.
	Recorded image is not saved.	<ol style="list-style-type: none"> 1. Loss of power before image is stored in memory 2. Memory card cover was opened before the image was fully saved. 	<ol style="list-style-type: none"> 1. Replace the battery with a new one (page E-41). 2. Never open the memory card cover until the image is fully saved.

	Symptom	Probable Cause	Action
Playback	Colors of recorded image are different from those on the display when image was composed.	<ol style="list-style-type: none"> 1. Reflection from sunlight or light from another source 2. Image quality setting 	<ol style="list-style-type: none"> 1. Reorient the camera so that light is not shining directly into lens. 2. Use the REC Menu to change to a higher image quality for recording.
	No [▶]/[◀] button operation during nine-page display	Button operation during page change	Wait until an image is on the monitor screen before performing a button operation.
	Cannot find an image.	Memory card images recording using a camera that does not support DCF.	The file management systems of cameras that do not support DCF are different from the one used by this camera. This camera cannot read cards recorded with such cameras.
	Camera is connected to a TV, but LCD monitor contents do not appear on TV screen.	<ol style="list-style-type: none"> 1. Incorrect camera-TV connection 2. Wrong TV set up 3. Wrong video mode is selected. 	<ol style="list-style-type: none"> 1. Connect correctly using the video cable (page E-104). 2. Set up the TV correctly. 3. Change the video mode.
	Images cannot be displayed when downloaded back to the camera from a computer.	The images were on a memory card when they were opened on the computer for editing and then resaved back to the memory card.	Use the Photo Loader application to download edited images back to the camera.
Deletion	Delete operation does not operate.	All images are protected.	Unprotect the images you want to delete (page E-94).

TROUBLESHOOTING

	Symptom	Probable Cause	Action
Other	Cannot select items in the PLAY Menu.	Some functions are not available for playback of certain types of images.	Select a different function or change to the REC Mode.
	No buttons or switches operate.	<ul style="list-style-type: none">Malfunction due to static electrical charge or strong impact.Camera is connected to a computer.	Remove batteries and disconnect the AC adapter if you are using one. Restore power and turn the camera on. If this does not work, contact your dealer or an authorized CASIO service provider.
	Nothing appears on the monitor screen.	<ol style="list-style-type: none">The camera is in the Sleep state.Communication over the USB cable is in progress.	<ol style="list-style-type: none">Exit the Sleep state.After the communication operation over the USB cable is complete unplug the USB cable from the camera.

MESSAGES

Can't play PANORAMA

This message appears when there is not enough memory to perform panorama recording. Delete some images from the memory card to make room for the new image.

CF ERROR You must format the CompactFlash card before using it with this camera.

FORMAT→MENU

Perform the following procedure whenever a memory card starts to behave abnormally.

Important!

- The procedure described below deletes all images stored in the memory card. Make sure all of your important images are backed up onto a computer hard disk or other storage medium before performing this procedure.

To reformat a memory card

1. Connect the AC adapter to the camera and switch to AC power or load fully-charged lithium ion battery into the camera.
 - Power failure while a format operation is being performed aborts the reformat operation.
2. Press MENU.



3. Use [▼] and [▲] to select "Yes", and then press SET/Q.
 - Select MENU if you want to abort the reformat procedure without deleting anything.
 - Completion of the format operation is indicated by the message "NO IMAGE" appearing on the monitor screen. This message also indicates that the memory card was formatted successfully.
-

MEMORY FULL Change quality or delete unneeded images.

Not enough memory for recording in the current quality mode. Change to another quality mode, or delete some images from the memory card (pages E-58, 96).

MEMORY FULL Delete unneeded images.

- Not enough memory for further recording. Delete some images from memory card (page E-88).
 - DCIM folder or other file (page E-105) cannot be created due to insufficient memory when downloading data from a computer to the memory card. Use your computer to delete unneeded images to free up memory card space for the images you are downloading. You could also press the MENU button and format the memory card in the camera, but doing so deletes all image files currently stored on the memory card.
-

NO FORMAT

The memory card is not formatted. Format the memory card before trying to use it (page E-38).



There is no memory card installed in the camera.

MESSAGES

RECORD ERROR This message appears when the image you are trying to record cannot be compressed for some reason. Try changing the angle of the camera to the subject.

REPLACE BATTERY! Battery power is low. Camera power turns off automatically shortly after this message appears.

There are no images on this memory card! No images are stored in memory card.

This camera cannot display the image you selected! The JPEG image file you are trying to display is either corrupted or is a format that is not compatible with this camera.

SPECIFICATIONS

- Description** Digital camera
- Model** QV-3EX
- Recorded Image File Format** Still images (including panoramas): JPEG (Exif. Ver. 2.1), DCF standard (Design rule for Camera File system), DPOF compatible, Movies: AVI
- Recording Medium** CompactFlash card (Type I/II)
- Recorded Image Size** 2016 x 1536 pixels, 1008 x 768 pixels
- Standard Memory Capacity, Number of Image Files, Computer Output Image Size**

Still					
Image size (pixels)	Quality	File size	Number of images		
			8MB CompactFlash card	64MB CompactFlash card	340MB Microdrive
2016 x 1536	FINE	1.4 MB/image	5 images	43 images	245 images
	NORMAL	1 MB/image	6 images	60 images	342 images
	ECONOMY	600 KB/image	11 images	99 images	562 images
1008 x 768	FINE	350 KB/image	19 images	167 images	943 images
	NORMAL	250 KB/image	27 images	229 images	1292 images
	ECONOMY	150 KB/image	43 images	365 images	2054 images

Movie	
Storage Capacity	220 KB/second
Recording Time	30 seconds per movie (NORMAL) 10 seconds per movie (PAST)

- The above figures are approximations only.

- Image Deletion** Currently Selected image; Single image; all images in a folder; all images in memory (with image protection)
- Imaging Element** 1/1.8-inch CCD (Total Pixels: 3.34 million, Effective Pixels; 3.24 million)
- Lens** F2.6; f = 8.1mm (equivalent to 40mm lens for 35mm film)
- Zoom** 12-step digital zoom (1, 1.2, 1.4, 1.6, 1.8, 2, 2.2, 2.4, 2.6, 2.8, 3, 3.2)
Image size: 1008 x 768 pixels
- Focusing** Contrast-detect Auto Focus; manual focus with macro mode, Infinity mode, and focus lock
- Focus Range** Normal focus: 0.5m to ∞ (1.6' to ∞)
Macro focus: 10cm to 50cm (3.9" to 19.7")
(approximately 10cm to ∞ (3.9" to ∞) with manual focus), from surface of protective lens filter
- Exposure Control**
Light Metering: Multi-pattern, average, spot by CCD
Exposure: Program AE, Aperture priority AE, Manual expose
Exposure Compensation: -2EV to +2EV (1/3EV units)
Exposure Range: Approximately EV4 to EV6
- Shutter** CCD electronic shutter; mechanical shutter, 1 to 1/3000 second
- Aperture** F2.6/4.2/6.6, auto switching or manual switching

SPECIFICATIONS

White Balance Automatic, fixed (4 modes), manual switching

Self-timer 10 seconds, 2 seconds

Built-in Flash

Flash Modes: AUTO, OFF, ON, Red eye reduction

Flash Range: Approximately 0.7 to 3 meters (2.3' to 9.8')

Recording Functions Program AE Mode (P Mode), Aperture Priority Auto Mode (A Mode), Manual Mode (M Mode), One-shot, Continuous, AEB, Macro, Movie, Panorama, Night scene, Landscape, Monochrome and Sepia, Self-timer

Monitor 1.8" TFT, low-glare color HAST LCD (122,100 pixels, 555 x 220)

Viewfinder LCD Monitor or Viewfinder

Clock Built-in quartz digital timepiece for time and date recording and storage with image data; auto calendar up to 2049

Input/Output Terminals DIGITAL IN/OUT, USB port (special mini port), AC adapter connector, VIDEO OUT (NTSC, PAL)

Power Supply Lithium Ion Rechargeable Battery (NP-L7)
AC adapter (AD-C620)
AC Adapter/Charger (BC-7LA)

Battery Life

The values noted below indicate the number of hours before battery failure under normal operating temperature (25°C). These values are for reference only, and do not guarantee that any particular set of batteries actually will provide the service life indicated. Low temperatures shorten battery life.

Battery Type	Approximate Continuous Play Time	Approximate Continuous Record Time
NP-L7 Lithium Ion Rechargeable Battery	100 minutes	65 minutes (390 shots) with the monitor screen turned on
		270 minutes (1,620 shots) with the monitor screen turned off

Continuous recording values show the number of shots without using the flash. The number of shots depends on use of the flash and whether flash is turned on or off.

Power Consumption Approximately 7.5W

Dimensions 114.8(W) x 62(H) x 32.8(D) mm
(4.5"(W) x 2.4"(H) x 1.3"(D))

Weight Approximately 215g (7.6oz)
(excluding the battery)

Standard Accessories 8MB CompactFlash card; strap; soft case; USB cable; video cable; data transfer cable; CD-ROM; Lithium Ion Rechargeable Battery (NP-L7), AC Adapter/Charger (BC-7LA), User's Guide, Bundled Software user's Manual, AC Adapter/Charger User's Guide, Lithium Ion Rechargeable Battery User's Guide

- This camera does not have a separate battery to power its clock. Clock settings are cleared whenever power to the camera is cut off (by the battery going dead while the camera is not connected to AC power outlet with the AC adapter) for about 48 hours. After power is resumed, either by loading a fresh battery or connecting to an AC power outlet, you will have to set the correct time and date again.
- The liquid crystal panel built into this camera is the product of precision engineering, with a pixel yield of 99.99%. This also means, however that 0.01% of the pixels can be expected to fail to light or to remain lit at all times.

For the latest information about CASIO Digital Cameras and accessories, visit our website at:

<http://www.casio.com/>